

# JVC®

BC-D2300U HDTV UP CONVERTER

## HDTV UP CONVERTER

# BC-D2300U

## INSTRUCTIONS

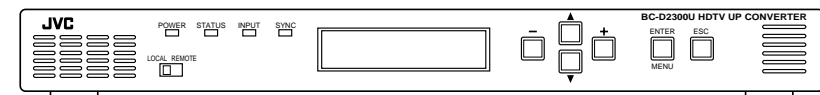

Thank you for purchasing this JVC product. Before operating this unit, please read the instructions carefully to ensure the best possible performance.

**For Customer Use:**

Enter below the Serial No., which is located on the top cover.  
Retain this information for future reference.

Model No. BC-D2300U \_\_\_\_\_

Serial No. \_\_\_\_\_

This instruction book is made from 100% recycled paper.

**JVC®**  
VICTOR COMPANY OF JAPAN, LIMITED

JVC® is a registered trademark owned by VICTOR COMPANY OF JAPAN, LTD.  
JVC® is a registered trademark in Japan, the U.S.A., the U.K. and many other countries.  
© 2001 VICTOR COMPANY OF JAPAN, LIMITED

Printed in Japan  
SS961574-002

SS961574-002

## IMPORTANT SAFEGUARDS

1. Read all of these instructions.
2. Save these instructions for later use.
3. All warnings on the product and in the operating instructions should be adhered to.
4. Unplug this appliance system from the wall outlet before cleaning. Do not use liquid cleaners or aerosol cleaners. Use a damp cloth for cleaning.
5. Do not use attachments not recommended by the appliance manufacturer as they may cause hazards.
6. Do not use this appliance near water – for example, near a bathtub, washbowl, kitchen sink, or laundry tub, in a wet basement, or near a swimming pool, etc.
7. Do not place this appliance on an unstable cart, stand, or table. The appliance may fall, causing serious injury to a child or adult, and serious damage to the appliance. Use only with a cart or stand recommended by the manufacturer, or sold with the appliance. Wall or shelf mounting should follow the manufacturer's instructions, and should use a mounting kit approved by the manufacturer. An appliance and cart combination should be moved with care. Quick stops, excessive force, and uneven surfaces may cause the appliance and cart combination to overturn.
8. Slots and openings in the cabinet and the back or bottom are provided for ventilation, and to insure reliable operation of the appliance and to protect it from overheating, these openings must not be blocked or covered. The openings should never be blocked by placing the appliance on a bed, sofa, rug, or other similar surface. This appliance should never be placed near or over a radiator or heat register. This appliance should not be placed in a built-in installation such as a bookcase unless proper ventilation is provided.
9. This appliance should be operated only from the type of power source indicated on the marking label. If you are not sure of the type of power supplied to your home, consult your dealer or local power company. For appliance designed to operate from battery power, refer to the operating instructions.
10. This appliance system is equipped with a 3-wire grounding type plug (a plug having a third (grounding) pin). This plug will only fit into a grounding-type power outlet. This is a safety feature. If you are unable to insert the plug into the outlet, contact your electrician to replace your obsolete outlet. Do not defeat the safety purpose of the grounding plug.
11. For added protection for this product during a lightning storm, or when it is left unattended and unused for long periods of time, unplug it from the wall outlet and disconnect the antenna or cable system. This will prevent damage to the product due to lightning and power-line surges.
12. Do not allow anything to rest on the power cord. Do not locate this appliance where the cord will be abused by persons walking on it.
13. Follow all warnings and instructions marked on the appliance.
14. Do not overload wall outlets and extension cords as this can result in fire or electric shock.
15. Never push objects of any kind into this appliance through cabinet slots as they may touch dangerous voltage points or short out parts that could result in a fire or electric shock. Never spill liquid of any kind on the appliance.
16. Do not attempt to service this appliance yourself as opening or removing covers may expose you to dangerous voltage or other hazards. Refer all servicing to qualified service personnel.
17. Unplug this appliance from the wall outlet and refer servicing to qualified service personnel under the following conditions:
  - a. When the power cord or plug is damaged or frayed.
  - b. If liquid has been spilled into the appliance.
  - c. If the appliance has been exposed to rain or water.
  - d. If the appliance does not operate normally by following the operating instructions. Adjust only those controls that are covered by the operating instructions as improper adjustment of other controls may result in damage and will often require extensive work by a qualified technician to restore the appliance to normal operation.
  - e. If the appliance has been dropped or the cabinet has been damaged.
  - f. When the appliance exhibits a distinct change in performance – this indicates a need for service.
18. When replacement parts are required, be sure the service technician has used replacement parts specified by the manufacturer that have the same characteristics as the original part. Unauthorized substitutions may result in fire, electric shock, or other hazards.
19. Upon completion of any service or repairs to this appliance, ask the service technician to perform routine safety checks to determine that the appliance is in safe operating condition.

PORTABLE CART WARNING  
(symbol provided by RETAC)



## SAFETY PRECAUTIONS



**CAUTION**  
RISK OF ELECTRIC SHOCK  
DO NOT OPEN

CAUTION: TO REDUCE THE RISK OF ELECTRIC SHOCK,  
DO NOT REMOVE COVER (OR BACK).  
NO USER-SERVICEABLE PARTS INSIDE.  
REFER SERVICING TO QUALIFIED SERVICE PERSONNEL



The lightning flash with arrowhead symbol, within an equilateral triangle, is intended to alert the user to the presence of uninsulated "dangerous voltage" within the product's enclosure that may be of sufficient magnitude to constitute a risk of electric shock to persons.



The exclamation point within an equilateral triangle is intended to alert the user to the presence of important operating and maintenance (servicing) instructions in the literature accompanying the appliance.



**ATTENTION**  
RISQUE D'ELECTROCUTION  
NE PAS OUVRIR

ATTENTION: POUR EVITER TOUT RISQUE D'ELECTROCUTION  
NE PAS OUVRIR LE BOITIER.  
AUCUNE PIECE INTERIEURE N'EST  
A REGLER PAR L'UTILISATEUR.  
SE REFERER A UN AGENT QUALIFIE EN CAS DE PROBLEME.



Le symbole de l'éclair à l'intérieur d'un triangle équilatéral est destiné à alerter l'utilisateur sur la présence d'une "tension dangereuse" non isolée dans le boîtier du produit. Cette tension est suffisante pour provoquer l'électrocution de personnes.



Le point d'exclamation à l'intérieur d'un triangle équilatéral est destiné à alerter l'utilisateur sur la présence d'opérations d'entretien importantes au sujet desquelles des renseignements se trouvent dans le manuel d'instructions.

\*Ces symboles ne sont utilisés qu'aux Etats-Unis.

**WARNING:**  
TO REDUCE THE RISK OF FIRE OR ELECTRIC SHOCK, DO NOT EXPOSE THIS APPLIANCE TO RAIN OR MOISTURE.

This unit should be used with 120 V AC only.

**CAUTION:**  
To prevent electric shocks and fire hazards, do NOT use any other power source.

### NOTE:

The rating plate (serial number plate) is on the top cover.

### INFORMATION

This equipment has been tested and found to comply with the limits for a Class A digital device, pursuant to Part 15 of the FCC Rules. These limits are designed to provide reasonable protection against harmful interference when the equipment is operated in a commercial environment. This equipment generates, uses, and can radiate radio frequency energy and, if not installed and used in accordance with the instruction manual, may cause harmful interference to radio communications.

Operation of this equipment in a residential area is likely to cause harmful interference in which case the user will be required to correct the interference at his own expense.

### CAUTION

CHANGES OR MODIFICATIONS NOT APPROVED BY JVC COULD VOID USER'S AUTHORITY TO OPERATE THE EQUIPMENT.

This Class A digital apparatus meets all requirements of the Canadian Interference-Causing Equipment Regulations.

**AVERTISSEMENT:**  
POUR EVITER LES RISQUES D'INCENDIE OU D'ELECTROCUTION, NE PAS EXPOSER L'APPAREIL A L'HUMIDITE OU A LA PLUIE.

Ce magnétoscope ne doit être utilisé que sur du courant alternatif en 120 V.

**ATTENTION:**  
Afin d'éviter tout risque d'incendie ou d'électrocution, ne pas utiliser d'autres sources d'alimentation électrique.

### REMARQUE:

La plaque d'identification (numéro de série) se trouve sur le panneau arrière de l'appareil.

Cet appareil numérique de la classe A respecte toutes les exigences du Règlement sur le matériel brouilleur du Canada.

## CONTENTS

Major features .....	4
Notes on settings and use .....	4
Handling precautions .....	4
Installation in a rack .....	4
<b>Controls, indicators and connectors</b>	
Front panel .....	5
Rear panel .....	6
<b>Menu settings</b>	
Setting the menu .....	7
Sub menu .....	7
Storing menu settings in memory of this unit .....	8
Recalling stored menu settings or factory default settings .....	8
Entering characters .....	9
Menu contents .....	10
<b>Others</b>	
Error output .....	16
Rear panel connectors .....	18
Installing the power cable hook .....	18
Specifications .....	19
Supplement .....	21

### Optional software

For optional software, consult your JVC dealer. Using it without formal procedures is illegal.

## MAJOR FEATURES

- This unit converts SMPTE259M-standard SD digital serial signal input to the SMPTE292M-standard (1080i or 720P) HD digital serial signal for output.
- Conversion modes are provided for input NTSC video signals with an aspect ratio of 4:3 (standard), in the letter box format or squeezed.
- The delay time for video conversion is added to the embedded audio to synchronize audio and video for output.
- Input signal can be cropped (in the 4:3 mode, independently for the left and right sides)
- Background color can be set with hue, saturation and lightness.
- It is possible to set or show the model name (up to 10 characters).
- Each function can be set on the front panel with the LCD. The unit can also be remote-controlled via the 9-pin connector on the rear panel (RS-485 or RS-232C).
- Menu settings can be saved in memory and loaded from memory.
- Four independent memories are provided to store menu settings. Stored menu settings can be recalled as required.
- Compact design allows this unit to be installed in a 1U EIA rack.
- Color bar output possible.
- External reference sync signal input connector
- Three video/audio output connectors
- Enhancer (contour correction), motion sensitivity, background color, screen horizontal/vertical position and system phase can be adjusted.
- Error indication and alarm signal output function
- Color correction function (option)
- Variable enhancer (option)

## NOTES ON SETTINGS AND USE

- When the menu item <Reference> is set to [INPUT] and there is no SD input signal, output video signals may be distorted. In this case, input external sync signals and set <Reference> to [BB] or [HD-SYNC]. (☞ p. 10).
- When the menu item <Reference> is set to [BB] or [HD-SYNC] and these external sync signals are not input or are incorrect, output video signals may be distorted. In this case, system phase cannot be assured. (☞ p. 10)

## HANDLING PRECAUTIONS

- Avoid using this unit in places subject to the following conditions:
  - direct sunlight
  - high humidity and dust
  - vibrations
  - extreme heat
 These conditions can cause problems and may damage the unit.
- Influence of strong electric waves and magnetism
  - Noise may appear on the screen when used in places close to a transmission antenna, or in places near transformers and motors where strong magnetism can occur.
- This equipment is meant for use exclusively in commercial and industrial applications. If used at home, it may cause interference with radio and television reception.
  - To save electricity, shut off the power when the unit is not in use.
  - Use the supplied power cable for this unit.
  - Do not place heavy objects such as a television monitor on top of the unit. Doing so could cause damage or adversely affect performance.
  - Do not put any foreign objects into the unit.
  - Do not disassemble the unit or try to modify it.
  - Do not block the ventilation openings.
  - Change the cooling fan about three years after installation of the unit.
- When cleaning the cabinet, wipe it with soft cloth. Do not use benzene or thinner as these may deform or discolor the cabinet surface. To remove excessive dirt, clean the unit with a mild detergent diluted with water, then wipe it with dry cloth.
- Do not use the unit in an environment exposed to gases generated by chemicals or organic solvents.

## INSTALLATION IN A RACK

This unit can be installed in EIA standard rack. Ensure sufficient rack strength by attaching L-metal supports on both sides of the rack on which you will place the unit.

1. Detach the four feet on the base of the unit.
2. Install the supplied rack mount brackets on both sides of front panel using the four supplied screws (M4).
3. Set this unit on the rack, and fix the rack mount brackets onto the rack using the four supplied screws (M5).

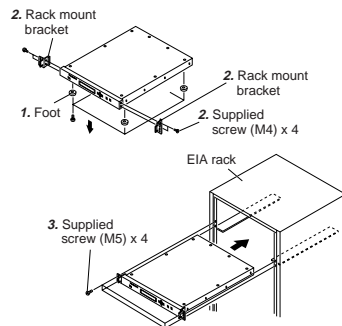

☞ See "Supplement" on page 21.

## CONTROLS, INDICATORS AND CONNECTORS

### Front panel

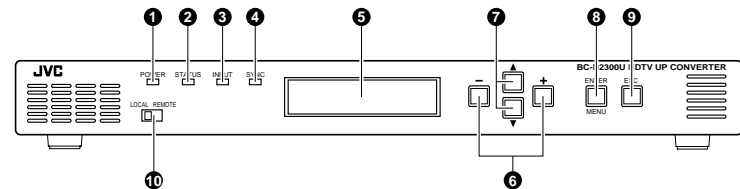

- [POWER] indicator**  
Lights green when power is supplied to this unit.
- [STATUS] indicator**  
Normally lights green. Lights orange in the menu setting mode, when the set value is changed or the set data is transmitted to this unit. When the transmission is complete, this indicator lights green again. When errors occur in hardware, etc., this indicator lights red.
- [INPUT] indicator**  
Normally lights green. When no signal is input, this indicator lights orange. If there is an error in the input signals, this indicator lights red.
- [SYNC] indicator**  
Normally lights green. If a sync system-related error occurs, this indicator lights red.
  - For details on error indicators, see page 17.
- Display**
  - When power is applied, the input/output or screen display mode is shown. (Normal display mode)
- [+/-] button**  
Press this button to change the set value for a menu item in the menu setting mode.
- [▲/▼] button**  
Press this button to select the menu item in the menu setting mode.
- [ENTER/MENU] button**
  - In the normal display mode, press this button to engage the menu setting mode.
  - In the menu setting mode, press this button to enter the set value for the following menu item. (? is shown.)
    - Output Mode item
    - Output item
    - Profile Save item
    - Profile Load item
  - Use to enter the sub menu. ([ENTER] is shown.)
- [ESC] button**  
In the menu setting mode, press this button to restore the normal display mode.

### Memorandum:

- To use the menu setting, refer to pages 7 to 9.

### [LOCAL/REMOTE] switch

- Use to select LOCAL or REMOTE to operate this unit.
- LOCAL** : Set to this position to operate this unit with the operation buttons on this unit.
- REMOTE** : Set to this position to remote-control this unit via the [REMOTE IN] connector or [ALARM] connector on the rear panel. Also, set to this position to lock the front panel's operation buttons.

- The factory preset is LOCAL.

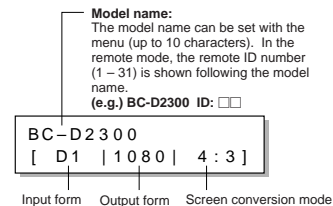

### Memoranda:

- The screen conversion mode can be selected with menu <Output Mode>. (☞ p. 10).
- Output form can be selected with menu <Output>. (☞ p. 10).
- When menu <Color Correction> is set to "ON" or <Colorimetry> is set to "OFF", the normal display changes as follows.

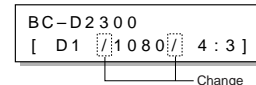

- Press the [ENTER/MENU] button to display the item in the menu setting mode.
- If an error occurs in the normal display mode, a description of the error is shown. (☞ p. 17).

Rear panel

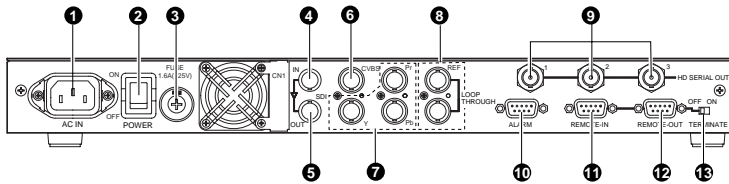

- 1 [AC IN] power input connector**  
Connect to an AC 120 V, 50 Hz/60 Hz power outlet with the provided power cable. Attach the provided hook beforehand. (p. 18).
- 2 [POWER] switch**  
Use to turn the power on/off. When the power is turned on, the indicators and display on the front panel light up.
- 3 Fuse holder**  
The fuse is built in. For fuse replacement, consult your nearest JVC dealer.
- 4 [SDI IN] connector**  
Input a SMPTE259M standard SD digital serial signal (NTSC). Compatible with embedded audio signals as well. Embedded 20-bit digital audio with 48 kHz sampling frequency can be input with 4 channels.
- 5 [SDI OUT] connector**  
Active through output of digital serial video/audio signals input to the 4 [SDI IN] connector is possible.
- 6 [CVBS] connector**  
Input analog composite signals (NTSC). The optional BC-D231 (D2/analog optional board) is required.
- 7 [Y/Pr/Pb] connectors**  
Input analog component signals (NTSC) to each connector. The optional BC-D231 (D2/analog optional board) is required.  
**Note:**  
• The [CVBS] and [Y/Pr/Pb] connectors are enabled only when the BC-D231 optional board is installed. For details, refer to the BC-D231 instruction manual.
- 8 [REF] external reference sync signal input connectors (loop-through)**  
Input external reference sync signal. As these connectors use a loop-through system, signals input to one connector can be distributed from another connector to the other equipment.  
**Memoranda:**  
• When signal distribution is not required or this unit is a terminating device, terminate this unit with the external 75-ohm terminator.  
• When the signals input to these connectors are used as a reference sync signal, set the menu switch <Reference> to "B.B" or "HD SYNC". (p. 10).  
• When the signals input to these connectors are used as a reference sync signal, synchronize the input signal with the reference sync signal so that the V sync is within ±300 μs.
- 9 [HD SERIAL OUT] HD digital serial output connectors (3 lines)**  
Output SMPTE292M standard HD digital serial signals. Output embedded digital audio signals with 20-bit 48 kHz sampling frequency as 4-channel signals.
- 10 [ALARM] connector ... D-sub 9-pin (male)**  
• This connector is an alarm output (relay contact) connector. When a problem occurs with this unit, an alarm signal is output.  
• When menu switch <Remote Port> is set to "ALARM", remote operation via the RS-232C is possible. To remote-control this unit via this connector, set the [LOCAL/REMOTE] switch on the front panel to "REMOTE".
- 11 [REMOTE-IN] connector ... D-sub 9-pin (female)**  
This connector is the input connector for remote-control device.  
Connect this connector to a device conforming to the RS-485 serial interface standard.  
**Memoranda:**  
• To use this connector, set menu switch <Remote Port> to "REMOTE-IN".  
• Set the remote ID and remote transmission speed with the menu switches.  
• To remote-control this unit, set the [LOCAL/REMOTE] switch on the front panel to "REMOTE".
- 12 [REMOTE-OUT] connector ... D-sub 9-pin (female)**  
Outputs the control signals input to the 11 [REMOTE-IN] connector or 10 [ALARM] connector as signals conforming to the RS-485 serial interface. Connect this connector to the [REMOTE IN] connector of another device. Up to 31 devices can be connected in series with this connection.
- 13 [TERMINATE] switch**  
This is the terminating switch for remote control signals. With a series connection, set this switch to "ON" when this unit is terminated or control signals from the [ALARM] connector are received.  
• The factory preset is "OFF".

MENU SETTINGS

You can set various functions on the menu. Settings are stored and automatically activated whenever you turn on the power. Up to four independent menu settings can be stored in the unit's memory and recalled at any time. You can also restore the default factory settings at any time. The menu is shown on the display.

Setting the menu

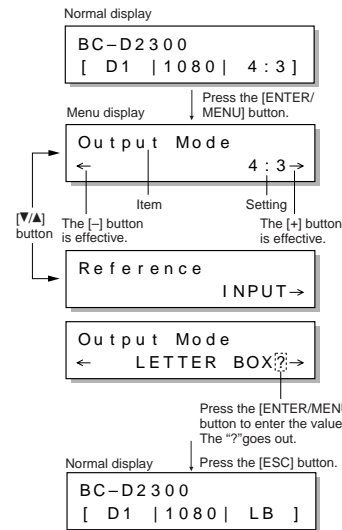
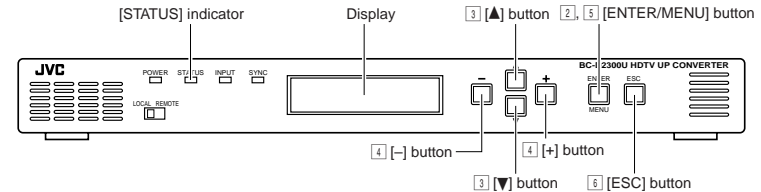

- 1 Turn the power of this unit ON.**  
The model name, input/output and screen display mode are shown on the display (normal mode).
- 2 Press the [ENTER/MENU] button to engage menu setting mode.**  
• The display shows the menu. The current setting is shown.
- 3 Press the [V] or [A] button to select the menu item.**
- 4 Press the [+] or [-] button to change the setting.**  
**Memoranda:**  
• When "—" is shown at the right of the display, press the [+] button to change the setting. When "—" is shown at the left of the display, press the [-] button.  
• When "?" appears after the value you want to set, press the [ENTER/MENU] button to enter the setting.  
• When the setting is changed, the [STATUS] indicator lights orange while the set data is transmitted to this unit. When the transmission is complete, this indicator lights green.  
■ Refer to the next page for details on how to store menu setting contents in memory.
- 5 Press the [ESC] button to end menu setting.**  
• Your changes are stored in memory and the display returns to normal.  
**Note:**  
If power is turned OFF without pressing the [ESC] button, setting changes are not saved.

Sub menu

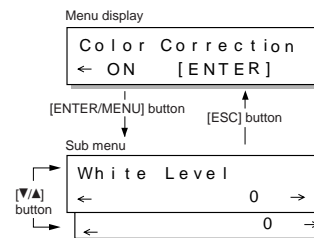

- Exact settings for variable enhancer (option), color correction (option) and administration can be done on the sub menu.
- 1.** When setting the variable enhancer or color correction to ON, or selecting administration, [ENTER] is shown on the display. To enter the sub menu, press the [ENTER/MENU] button.
  - 2.** Set each menu item in the same way as with the ordinary menu.
  - 3.** Press the [ESC] button to go to the upper menu by one.

## MENU SETTINGS

### Storing menu settings in memory of this unit

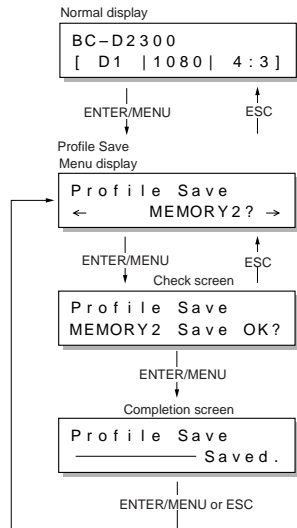

- 1 Press the [ENTER/MENU] button to engage the Menu Display mode.
  - 2 Select Profile Save with the [▼] or [▲] button.
  - 3 Select the memory number where you want to store the menu settings with the [+] or [-] button (one of MEMORY 1 to 4).
    - The "?" is added to the end of the selected memory number.
  - 4 Press the [ENTER/MENU] button.
    - The check screen is shown for confirmation.
  - 5 Press the [ENTER/MENU] button again to confirm the setting.
    - The menu settings are stored in the selected memory. Once the settings have been stored, the completion screen is shown.
- Memorandum:**
- When the check screen is shown, press the [ESC] button to cancel it. The previous Profile Save menu setting display is restored.
- 6 Press the [ENTER/MENU] button or [ESC] button.
    - Menu setting display is restored.
  - 7 Press the [ESC] button to restore the normal display.
 

**Note:**

    - Settings for Remote ID, Remote Speed and Remote Port are not stored in memory for each Profile. One value is used for all profiles.

### Recalling stored menu settings or factory default settings

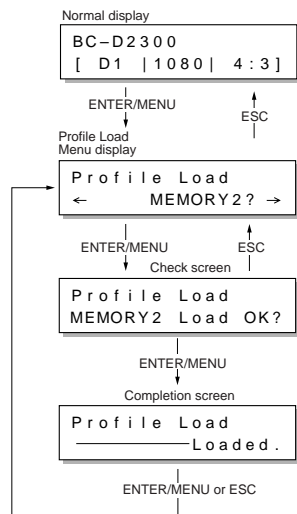

- 1 Press the [ENTER/MENU] button to engage the Menu Display mode.
  - 2 Select Profile Load with the [▼] or [▲] button.
  - 3 Select the memory to be recalled (MEMORY 1 to 4, DEFAULT) with the [+] or [-] button. When DEFAULT is selected, the factory setting is recalled.
  - 4 Press the [ENTER/MENU] button.
    - Display the check screen for confirmation.
  - 5 Press the [ENTER/MENU] button again to confirm.
    - The selected settings are recalled. When completed, the completion display is shown.
- Memorandum:**
- When the check screen is shown, press the [ESC] button to cancel it. The previous Profile Load menu setting display is restored.
- 6 Press the [ENTER/MENU] button or [ESC] button.
    - Menu setting display is restored and the recalled menu settings are activated.
  - 7 Press the [ESC] button to restore the normal display.
 

**Memorandum:**

    - The factory default settings are stored in MEMORY 1 to 4.

### Entering characters

Enter characters to set the model name and the [License key].

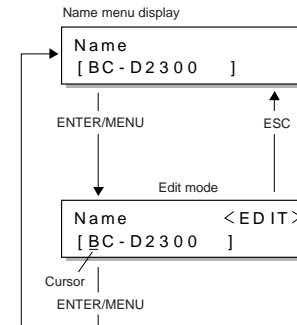
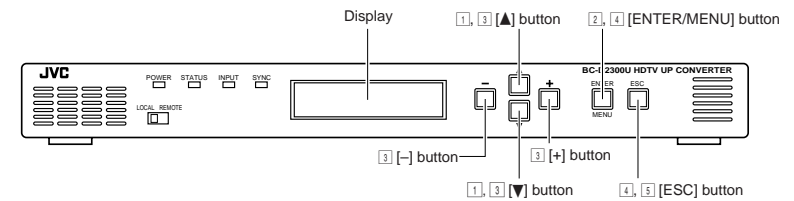

An example of model name setting is shown below.

- 1 Select [Name] in the sub menu for administration.
    - The currently-set device name is shown.
  - 2 Press the [ENTER/MENU] button.
    - The Edit mode is engaged and the cursor appears.
  - 3 Move the cursor with the [+] or [-] button. Change the characters with the [▼] or [▲] button (up to 10 characters).
  - 4 Press the [ENTER/MENU] button to store the device name in memory.
    - The setting is refreshed and the name menu display is restored.
- Press the [ESC] button to interrupt editing and restore the previous setting.
- The changed setting is canceled and the name menu is restored.
- 5 To restore the normal display, press the [ESC] button.

## MENU SETTINGS

### Menu contents

[ ]: Factory Setting

Items	Settings	Contents
<b>Output Mode</b>  <b>Note:</b> <ul style="list-style-type: none"> <li>The following menu item values can be saved for each setting mode.</li> <li>V Position</li> <li>Motion Sense</li> <li>Enhance Level</li> <li>Variable Enhancer and 5-related item (option)</li> </ul> When the setting for Output Mode is changed, check the setting of the above menu items.	[4:3] LETTER BOX SQUEEZE	Sets the HD Conversion mode according to the NTSC video source. <b>4 : 3</b> : When the input video has an aspect ratio of 4:3, it is converted to HD pictures without changing the aspect ratio for output. In this case, the side panels appear on the screen. <b>LETTER BOX</b> : When the input video is in the LETTER BOX format, it is converted to HD pictures with an aspect ratio of 16:9 for output. <b>SQUEEZE</b> : When the input video has been "squeezed" for display on 4:3 screens, it is converted to HD pictures with an aspect ratio of 16:9 for output.  
<b>Output</b>	[1080I] 720P	Sets the output video format. <b>1080I</b> : Effective 1080 scanning lines, interlace. <b>720P</b> : Effective 720 scanning lines, progressive.
<b>Reference</b>  <b>Note:</b> <ul style="list-style-type: none"> <li>System Phase settings can be saved for each of these item settings.</li> </ul>	[INPUT] BB HD-SYNC	Selects the reference sync signal. <b>INPUT</b> : Synchronizes with the video signal input to the [SDI IN] connector of this unit. <b>BB</b> : Synchronizes with the black burst signal input to the [REF] connector of this unit. <b>HD-SYNC</b> : Synchronizes with the tri-sync input to the [REF] connector of this unit. Tri-sync must be input in the same signal form as the output setting.  <b>Note:</b> <ul style="list-style-type: none"> <li>When this is set to "BB" or "HD-SYNC", the V sync position of these external signals and video input signals must synchronize within <math>\pm 300 \mu\text{s}</math>.</li> </ul>
<b>System Phase</b>	-300 ∴ [0] ∴ 300	Sets the HD output signal phase for the reference sync signal selected with <Reference>. (Variation for $\pm 300$ is equivalent to about $\pm 4 \mu\text{s}$ .)
<b>H Position</b>	-120 ∴ [0] ∴ 120	Adjusts the picture's horizontal display position (varies in $\pm 120 \times 2$ pixels). <ul style="list-style-type: none"> <li>This item is enabled only when the Output Mode is set to 4:3.</li> <li>When the &lt;Output&gt; item is set to "720P", the actual display position area is <math>\pm 80 \times 2</math> pixels. Keep in mind that this is different from the value set with the menu.</li> </ul>
<b>H Crop (Left)</b>	[0] ∴ 100	Sets the crop width at the left of the input picture. <ul style="list-style-type: none"> <li>This item is enabled only when the Output Mode is set to 4:3.</li> </ul> For the part cropped, the background color is shown.
<b>H Crop (Right)</b>	-100 ∴ [0]	Sets the crop width at the right of the input picture. <ul style="list-style-type: none"> <li>This item is enabled only when the Output Mode is set to 4:3.</li> </ul> For the part cropped, the background color is shown.

### Menu contents (contd.)

The items in the shaded area are shown when the optional software is installed.

[ ]: Factory Setting

Items	Settings	Contents
<b>V Position</b>	-63 ∴ [0] ∴ 63	Adjusts the picture's vertical position (varies in $\pm 63$ lines).  <b>Note:</b> <ul style="list-style-type: none"> <li>When &lt;Output Mode&gt; is set to "4:3" or "SQUEEZE", the actual variable range is <math>\pm 3</math> lines. Keep in mind that this is different from the value set with the menu.</li> </ul>
<b>Motion Sense</b>	0 ∴ [8] ∴ 15	Motion detection sensitivity adjustment Sets the optimum conversion sensitivity according to the input material. Normally use the factory setting.
<b>Enhance Level</b>	-5 ∴ [0] ∴ 15	Adjusts the enhancer (contour compensation) of the video output signal. Varies in 20 steps. Use this 2-dimensionally (horizontal and vertical). When the optional variable enhancer function is enabled, the variable enhancer menu is shown instead of this item.
<b>Variable Enhancer</b>	OFF [ON]	Sets ON/OFF of the variable enhancer function. When set to "OFF", the enhancer is disabled. When set to "ON", the variable enhancer functions based on the values of the following five items. The following five parameters can be displayed and set on the sub menu by pressing the [ENTER/MENU] button. (p. 7 for sub menu) <ul style="list-style-type: none"> <li>This item is shown only when the optional variable enhancer function is enabled.</li> </ul>
<b>Enhance Level</b>	-5 ∴ [0] ∴ 15	Sets the enhancement level. <ul style="list-style-type: none"> <li>This item is shown when the optional variable enhancer function is enabled and &lt;Variable Enhancer&gt; is set to "ON".</li> </ul>
<b>Enhance Freq</b>	2 ∴ [4] 5	Sets the frequency of the input signal to be enhanced. <ul style="list-style-type: none"> <li>This item is shown when the optional variable enhancer function is enabled and &lt;Variable Enhancer&gt; is set to "ON".</li> </ul>
<b>Cut Off Freq</b>	3 ∴ [7]	Sets the band limit frequency of the input signal. When set to 7 (MHz), band limitation is not performed. <b>Note:</b> When the <Cut Off Freq> setting is smaller than the <Enhance Freq> setting, the enhancement function is disabled. <ul style="list-style-type: none"> <li>This item is shown when the optional variable enhancer function is enabled and &lt;Variable Enhancer&gt; is set to "ON".</li> </ul>
<b>Threshold</b>	[0] ∴ 15	Sets the threshold of the enhancement effect. If the enhancement effect is applied excessively, even low-level noise contained in the original picture will be emphasized. With this setting, the enhancement of a small amount of noise can be suppressed to emphasize only the contour. <ul style="list-style-type: none"> <li>This item is shown when the optional variable enhancer function is enabled and &lt;Variable Enhancer&gt; is set to "ON".</li> </ul>
<b>Noise Reduction</b>	[OFF] ON	When this item is set to "ON", a small amount of noise lower than the threshold level can be suppressed. The larger the threshold setting, the larger the effect to suppress noise. <b>Note:</b> This function has no effect unless <Enhance Level> is set to the larger value. <ul style="list-style-type: none"> <li>This item is shown when the optional variable enhancer function is enabled and &lt;Variable Enhancer&gt; is set to "ON".</li> </ul>

MENU SETTINGS

Menu contents (contd.)

[ ] : Factory Setting

Items	Settings	Contents
<b>Back Color Mode</b>	[YCbCr] HSL	Sets the method to specify the background color. YCbCr : Sets the output value of the background color. HSL : Sets the background color with the Hue, Saturation and Lightness values. <b>Note:</b> • When this setting is changed, the following three menu settings also change. In this case, the set value and color may be changed. If this setting is changed, check the color on the screen again.
<b>Back Color (Y)</b>	[64] : 940	Varies the background color brightness. With 4:3 aspect ratio picture input, this adjustment is applied to the side panels of the picture output. Set this by checking the screen. • This item is shown only when the Back Color Mode is set to YCbCr.
<b>Back Color (Cb)</b>	64 : [512] : 960	Varies the blue of the background color. With 4:3 aspect ratio picture input, this adjustment is applied to the side panels of the picture output. Set this by checking the screen. • This item is shown only when the Back Color Mode is set to YCbCr.
<b>Back Color (Cr)</b>	64 : [512] : 960	Varies the red of the background color. With 4:3 aspect ratio picture input, this adjustment is applied to the side panels of the picture output. Set this by checking the screen. • This item is shown only when the Back Color Mode is set to YCbCr.
<b>Back Color (L)</b>	[0] : 100	Sets the background color lightness. With 4:3 aspect ratio picture input, this adjustment is applied to the side panels of the picture output. Set this by checking the screen. • This item is shown only when the Back Color Mode is set to HSL.
<b>Back Color (S)</b>	[0] : 100	Sets the background color saturation. With 0, monochrome is shown. The larger the number, the higher the saturation. <b>Note:</b> • The saturation actually output is limited by the setting of the Back Color (L). Even though the Back Color (S) is set to 100, the picture will be monochrome if the Back Color (L) is set to 0 (black) or 100 (white). • This item is shown only when the Back Color Mode is set to HSL.
<b>Back Color (H)</b>	[0] : 359	Sets the background color hue. In most cases, the following colors can be obtained. 0: Red, 120: Green, 240: Blue • This item is shown only when the Back Color Mode is set to HSL.

Menu contents (contd.)

The items in the shaded area are shown when the optional software is installed. [ ] : Factory Setting

Items	Settings	Contents
<b>Color Correction</b>	[OFF] ON	• This menu is shown when the optional color correction function is enabled. Sets the color correction function ON/OFF. With OFF, the color correction function is disabled. With ON, the color is corrected based on the following 8 parameters (items). When this function is set to ON, the normal display format changes. (p. 5) The following eight parameters are shown and set on the sub menu when <Color Correction> is set to "ON" and the [ENTER/MENU] button is pressed.
<b>White Level</b>	-100 : [0] : 100	Adjusts the high brightness level of the input picture. • Can be set when the Color Correction is set to ON.
<b>Black Level</b>	-100 : [0] : 100	Adjusts the low brightness level of the input picture. • Can be set when the Color Correction is set to ON.
<b>White Color (B)</b>	-100 : [0] : 100	Adjusts the blue of the high brightness section of the input picture. • Can be set when the Color Correction is set to ON.
<b>White Color (R)</b>	-100 : [0] : 100	Adjusts the red of the high brightness section of the input picture. • Can be set when the Color Correction is set to ON.
<b>Back Color (B)</b>	-100 : [0] : 100	Adjusts the blue of the low brightness section of the input picture. • Can be set when the Color Correction is set to ON.
<b>Back Color (R)</b>	-100 : [0] : 100	Adjusts the red of the low brightness section of the input picture. • Can be set when the Color Correction is set to ON.
<b>Phase</b>	-179 : [0] : 180	Adjusts the phase of the input picture. • Can be set when the Color Correction is set to ON.
<b>Chroma</b>	-100 : [0] : 100	Adjusts the chroma of the input picture. With -100, the picture becomes black-and-white (monochrome). • Can be set when the Color Correction is set to ON.

## MENU SETTINGS

### Menu contents (contd.)

[ ]: Factory Setting

Items	Settings	Contents
Colorimetry	OFF [ON]	Turns the colorimetry parameter conversion function ON/OFF. This function allows SD (ITU-R601) to be converted to HD (ITU-R709). Normally, set to ON. When this function is set to OFF, the normal display format changes. (☞ p. 5)
Out Delay	[1FRAME] 1FRAME-90H	Sets the delay time from the input to the output. 1FRAME : Delays by 1 frame (33.37 ms). 1FRAME-90H : Delays by 1 frame -2.67 ms for 1080I. Delays by 1 frame -2.00 ms for 720P.
Audio Group	NO USE [1] 2 3 4	Selects the audio signal group (groups 1 to 4) multiplexed on the SD digital serial input signal. If audio is not used, select No Use.
Audio Delay	-30 : [0] : 30	Sets the delay for the audio signal multiplexed on the SD digital serial input signal. Adjustment of ±30 (msec.) is possible with respect to the delay time set with <Out Delay>.
Profile Save	MEMORY 1 MEMORY 2 MEMORY 3 MEMORY 4	Four independent memories are provided to store menu settings. Selects the memory to be used to store the set menu contents. * Items in the administration sub menu are not stored in memory.
Profile Load	MEMORY 1 MEMORY 2 MEMORY 3 MEMORY 4 DEFAULT	Recalls menu setting stored in memory. When set to DEFAULT, menu setting set before shipment is recalled.
Color Bar	[OFF] ON	When set to ON, the built-in color bar (7-line color bar) is output regardless of the input. The color bar output turns off automatically when you quit this menu.

### Menu contents (contd.)

[ ]: Factory Setting

Items	Settings	Contents
Administration		Press the [ENTER/MENU] button to enter the administration sub menu. The following nine items can be set on the administration sub menu.
Remote ID	[1] : 31	Sets the remote ID of this unit to remote-control this unit from the Host.
Remote Speed	9600 19200 [38400]	Sets the transmission speed (bit/s) of the remote control signal.
Remote Port	[REMOTE-IN] ALARM	Selects the connection port for the host when this unit is remote-controlled. <b>REMOTE-IN</b> : Connects RS-485 to the [REMOTE-IN] port. Set to this position to remote-control this unit via the [REMOTE-IN] connector. <b>ALARM</b> : Connect the RS-232C to the [ALARM] port. Set to this position to remote-control this unit via the [ALARM] connector.
Active Line	480 [486]	Sets the number of effective lines of the input signal when <Output> is set to "1080I". With <Output> set to "720P", the number is fixed at 480 lines (on the menu, --- is shown).
Alarm	OFF [ON]	When set to "OFF", the output from the rear panel's [ALARM] connector stops (always open except when power is turned off).
Name	[BC-D2300]	Sets the device name that will be shown in the normal display. For setting, refer to page 9.
Version		Shows the firmware version of this unit.
Serial No.		Shows the serial number of this unit.
License key		Sets the license key to enable optional features such as the variable enhancer and color compensation function. For setting, refer to page 9. To obtain the license key, consult your JVC dealer.
Running Time		Shows the approx. number of operating days of this unit. Press the [ENTER/MENU] button twice to clear this number to 0. Use this as a guide for determining when to replace the fan.



# OTHERS

When an abnormality is detected, error notification is provided by LED illumination, error indication on the display and error output to the [ALARM] connector.

## Error output

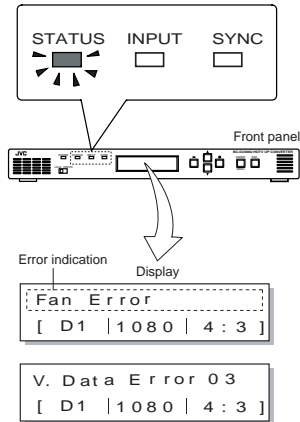

### 1. LED lighting

The [STATUS], [INPUT] or [SYNC] indicator on the front panel lights orange (warning) or red (error), depending on the type of error.

### 2. Display indication

The first line of the display shows a description of the error. When the menu is displayed, errors are not shown.

#### Memoranda:

- With LOCAL, the error indication is shown when the error is detected and goes out when the error is no longer detected. With REMOTE, once an error is detected, the indication remains (goes out when the switch is set to LOCAL).
- Error codes with 2 to 6 digits may be shown at the same time. In this case, report the error codes to your JVC dealer.

### 3. [Alarm] connector output

2-line alarm output terminals are provided for the rear panel's [ALARM] connector. Terminals A and B are short-circuited (relay contact) when an error occurs or the power is turned off. Normally, these terminals are open. (For open and short-circuited conditions, refer to the table on the next page.)

The maximum rated value is 30 V 0.5 A for AC/DC with non-inductive load.

#### Pin assignment of the [ALARM] connector

Pin number	Name	Contents
1	NC	Unconnected
2	(RD)	(Reception data for maintenance)
3	(SD)	(Transmission data for maintenance)
4	ALARM2-B	Alarm output 2 B terminal
5	GND	Signal ground
6	ALARM2-A	Alarm output 2 A terminal
7	ALARM1-A	Alarm output 1 A terminal
8	ALARM1-B	Alarm output 1 B terminal
9	NC	Unconnected

## Error output (contd.)

### Error indications and output contents

Error indications	Error contents	LED	ALARM 1	ALARM 2
Power Error	Abnormality in the power unit	STATUS: Red	Short-circuited	Open
Fan Error	Abnormality in the fan motor			
Data No-input (warning)	No video and audio signal is input.	INPUT: Orange	Open	Open
V. Format Error	Format error of the SDI input signals	INPUT: Red	Open	Short-circuited
V. Data Error	Error of video data in the SDI input signal			
A. Data Error	Error of audio data in the SDI input signal			
REF No-input	No external sync signal is input (note)	SYNC: Red	Short-circuited	Open
SD Unlock	Synchronization is not possible due to incorrect video input signals			
Ref Unlock	Synchronization is not possible due to incorrect external sync signal input			
Comm Error	Abnormal remote communication	STATUS: Red	Short-circuited	Open
Device Error	Abnormality in the internal device			
—	Power is turned off.	—	Short-circuited	Short-circuited

**Note:** When an incorrect external sync signal is input, the REF No-input error indication may be shown.

When an error indication is shown, check the input signal and connections according to type of error indicated. When this unit malfunctions, consult your nearest JVC authorized service agent. → **See "1.4 About Error Messages" on page 1-3.**

Rear panel connectors

Names	Functions	Types	Remarks
SDI IN	SD digital serial signal input	BNC	
SDI OUT	Active through output	BNC	
REF	External sync input	BNC	
REF	Loop-through	BNC	
HD SERIAL OUT 1	HD digital serial signal output	BNC	
HD SERIAL OUT 2	Same as above	BNC	
HD SERIAL OUT 3	Same as above	BNC	
CVBS	Analog composite input	BNC	The optional BC-D231 is required.
Y	Analog component Y input	BNC	
Pr	Analog component Pr input	BNC	
Pb	Analog component Pb input	BNC	
ALARM	[ALARM] connector/RS-232C	D-SUB	9-pin male, inch screw
REMOTE-IN	Remote control input	D-SUB	9-pin female, mm screw
REMOTE-OUT	Remote control bridge	D-SUB	9-pin female, mm screw

REMOTE-IN, REMOTE-OUT terminal pin assignment

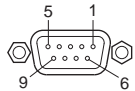

Note:

- For the REMOTE connection, use a straight cable which contains twisted paired lines for the signals of TxA and TxB, RxA and RxB.

Pin number	Signal name	I/O	Contents	Remarks
1	NC	—	Unconnected	
2	TxA	O	Transmission A	RS-485
3	RxB	I	Reception B	RS-485
4	SG	—	Signal ground	
5	NC	—	Unconnected	
6	SG	—	Signal ground	
7	TxB	O	Transmission B	RS-485
8	RxA	I	Reception A	RS-485
9	NC	—	Unconnected	

Installing the power cable hook

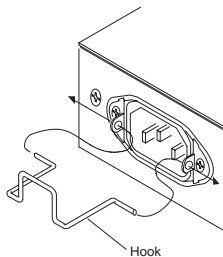

- Before connecting the power cable, install the supplied hook as shown on the left.
- After connecting the power cable, lower the hook to secure the power cable in place.

Specifications

Input signal

Video and audio

: SD digital serial signal (SMPTE259M) ..... 1 line  
 0.8 Vp-p, 75 ohms unbalanced, active-through  
 Bit rate: 270 Mbps

Sync signals

: Sync signal, 75 ohms unbalanced, loop through .... 1 line  
 B.B: 0.45 Vp-p (NTSC)  
 HD-SYNC: Positive and negative bipolarity tri-sync signal of 600 mVp-p ± 300 mVp-p

Output signal

Video and audio

: HD digital serial signal  
 (SMPTE292M) ..... 3 lines  
 0.8 Vp-p, 75 ohms unbalanced  
 Bit rate: 1.485/1.001 (1.483516) Gbps, 59.94 Hz  
 Effective scanning lines: 1080 lines (1080i), 720 line (720P)  
 Embedded audio signal: 4 ch, sampling frequency of 48 kHz

Quantization

Video resolution

: 10 bits

Audio resolution

: 20 bits

Signal delay amount

Video system

: 1 frame or 1 frame - 90H, the shortest delay setting not available

Audio system

: The same delay as the video delay time, can be adjusted by ±30 msec.

Conversion mode

: Three types (4:3 material, letter box material, squeezed material)

Power supply

: AC 120 V, 50 Hz/60 Hz

Power consumption

: 35 W

External dimensions (WHD)

: 430 mm x 489 mm x 50 mm  
 (16-15/16" x 19-5/16" x 2") (excluding fan motor and connectors)

Weight

: 6.2 kg (13.7 lbs.)

Using environment

Installation place

: In a room (install on a table or a rack)

Allowable operating temperature

: 10°C to 40°C (50°F to 104°F)

Allowable operating humidity

: 30%RH to 80%RH (with no condensation)

Allowable storage temperature

: -20°C to 60°C (-4°F to 140°F)

Provided accessories and options

- : Warranty card x 1
- : Instruction manual x 1
- : Service center list x 1
- : Power cable (2.5 m) x 1
- : Rack mount bracket x 2
- : Screw (M4) x 4
- : Screw (M5) x 4
- : Hook (for power cable) x 1

Specifications (contd.)

External dimensions (unit: mm)

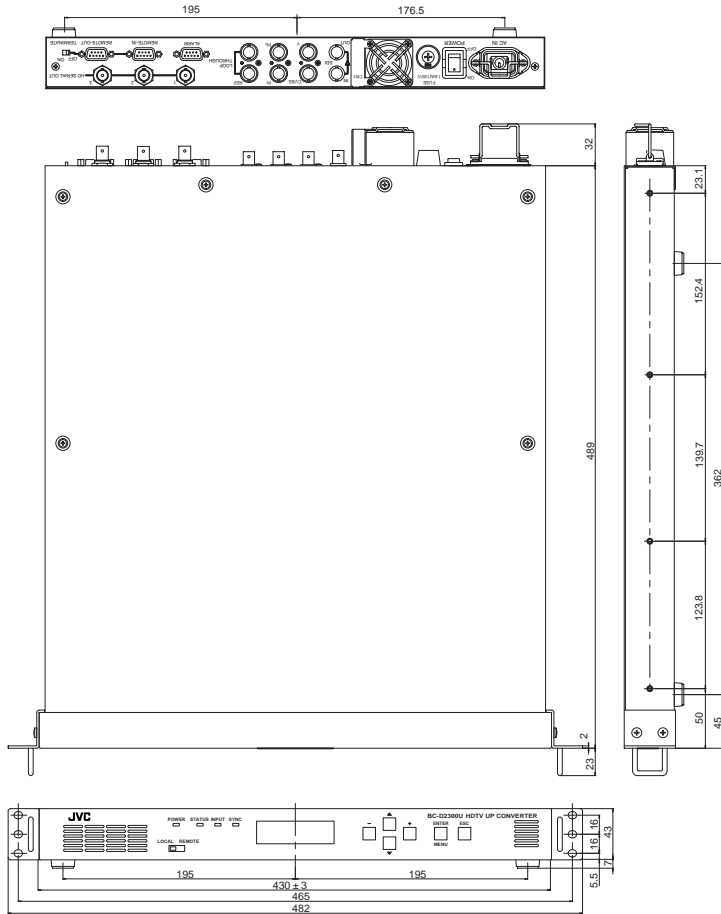

Design and specifications subject to change without notice.

Supplement

Attaching the L-metal support on EIA rack

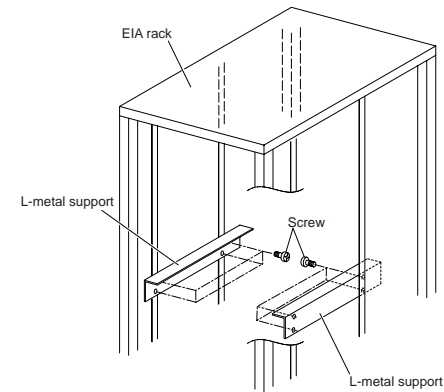

Put L-metal supports on the both sides of EIA rack to secure strength.

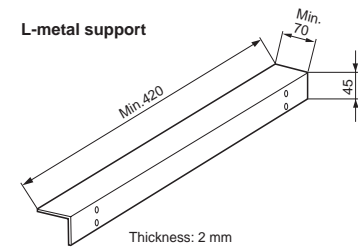

WARNING :

- Rack mounting is optional. Use only with racks that have fully adjustable vertical rack rails.
- Use the rack mount brackets (eras) and L-metal supports together. Do not use only the rack mount brackets (eras) by themselves for support.

MEMO

---

MEMO

---

## Free Manuals Download Website

<http://myh66.com>

<http://usermanuals.us>

<http://www.somanuals.com>

<http://www.4manuals.cc>

<http://www.manual-lib.com>

<http://www.404manual.com>

<http://www.luxmanual.com>

<http://aubethermostatmanual.com>

Golf course search by state

<http://golfingnear.com>

Email search by domain

<http://emailbydomain.com>

Auto manuals search

<http://auto.somanuals.com>

TV manuals search

<http://tv.somanuals.com>