

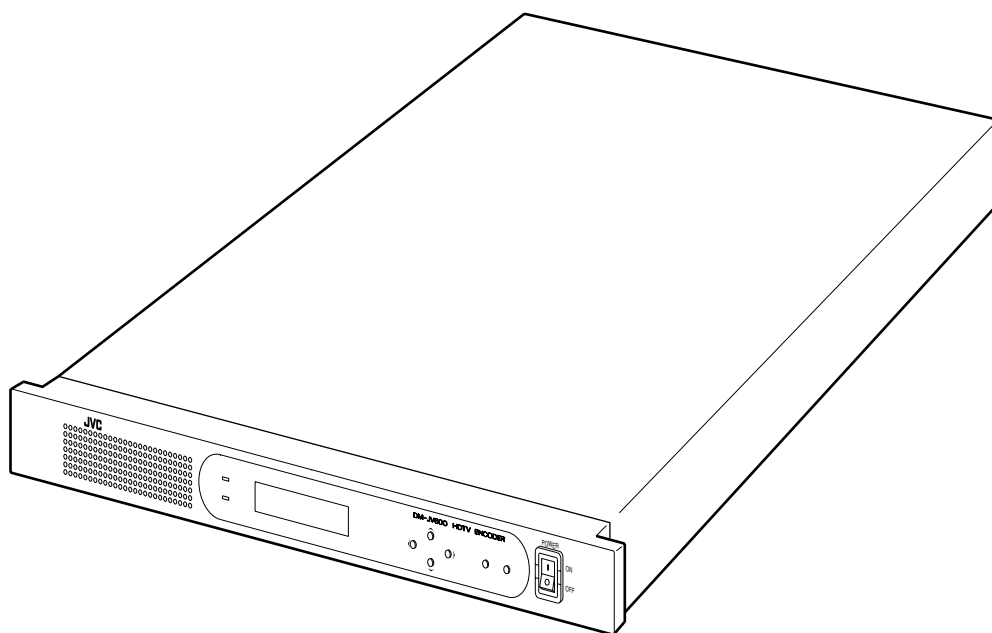

## HDTV ENCODER

# DM-JV600U

## INSTRUCTIONS



Thank you for purchasing this JVC product.  
Before operating this unit, please read the instructions  
carefully to ensure the best possible performance.

### For Customer Use:

Enter below the Serial No. which is  
located on the rear of cabinet. Retain  
this information for future reference.

Model No. DM-JV600U

Serial No. \_\_\_\_\_

# IMPORTANT SAFEGUARDS

1. Read all of these instructions.
2. Save these instructions for later use.
3. All warnings on the product and in the operating instructions should be adhered to.
4. Unplug this appliance system from the wall outlet before cleaning. Do not use liquid cleaners or aerosol cleaners. Use a damp cloth for cleaning.
5. Do not use attachments not recommended by the appliance manufacturer as they may cause hazards.
6. Do not use this appliance near water – for example, near a bathtub, washbowl, kitchen sink, or laundry tub, in a wet basement, or near a swimming pool, etc.
7. Do not place this appliance on an unstable cart, stand, or table. The appliance may fall, causing serious injury to a child or adult, and serious damage to the appliance.  
Use only with a cart or stand recommended by the manufacturer, or sold with the appliance.  
Wall or shelf mounting should follow the manufacturer's instructions, and should use a mounting kit approved by the manufacturer.  
An appliance and cart combination should be moved with care. Quick stops, excessive force, and uneven surfaces may cause the appliance and cart combination to overturn.
8. Slots and openings in the cabinet and the back or bottom are provided for ventilation, and to insure reliable operation of the appliance and to protect it from overheating, these openings must not be blocked or covered. The openings should never be blocked by placing the appliance on a bed, sofa, rug, or other similar surface. This appliance should never be placed near or over a radiator or heat register. This appliance should not be placed in a built-in installation such as a bookcase unless proper ventilation is provided.
9. This appliance should be operated only from the type of power source indicated on the marking label. If you are not sure of the type of power supplied to your home, consult your dealer or local power company. For appliance designed to operate from battery power, refer to the operating instructions.
10. This appliance system is equipped with a 3-wire grounding type plug (a plug having a third (grounding) pin). This plug will only fit into a grounding-type power outlet. This is a safety feature. If you are unable to insert the plug into the outlet, contact your electrician to replace your obsolete outlet. Do not defeat the safety purpose of the grounding plug.
11. For added protection for this product during a lightning storm, or when it is left unattended and unused for long periods of time, unplug it from the wall outlet and disconnect the antenna or cable system. This will prevent damage to the product due to lightning and power-line surges.
12. Do not allow anything to rest on the power cord. Do not locate this appliance where the cord will be abused by persons walking on it.
13. Follow all warnings and instructions marked on the appliance.
14. Do not overload wall outlets and extension cords as this can result in fire or electric shock.
15. Never push objects of any kind into this appliance through cabinet slots as they may touch dangerous voltage points or short out parts that could result in a fire or electric shock. Never spill liquid of any kind on the appliance.
16. Do not attempt to service this appliance yourself as opening or removing covers may expose you to dangerous voltage or other hazards. Refer all servicing to qualified service personnel.
17. Unplug this appliance from the wall outlet and refer servicing to qualified service personnel under the following conditions:
  - a. When the power cord or plug is damaged or frayed.
  - b. If liquid has been spilled into the appliance.
  - c. If the appliance has been exposed to rain or water.
  - d. If the appliance does not operate normally by following the operating instructions. Adjust only those controls that are covered by the operating instructions as improper adjustment of other controls may result in damage and will often require extensive work by a qualified technician to restore the appliance to normal operation.
  - e. If the appliance has been dropped or the cabinet has been damaged.
  - f. When the appliance exhibits a distinct change in performance – this indicates a need for service.
18. When replacement parts are required, be sure the service technician has used replacement parts specified by the manufacturer that have the same characteristics as the original part. Unauthorized substitutions may result in fire, electric shock, or other hazards.
19. Upon completion of any service or repairs to this appliance, ask the service technician to perform routine safety checks to determine that the appliance is in safe operating condition.

PORTABLE CART WARNING  
(symbol provided by RETAC)



# SAFETY PRECAUTIONS



**CAUTION**

RISK OF ELECTRIC SHOCK  
DO NOT OPEN



CAUTION: TO REDUCE THE RISK OF ELECTRIC SHOCK, DO NOT REMOVE COVER (OR BACK). NO USER-SERVICEABLE PARTS INSIDE. REFER SERVICING TO QUALIFIED SERVICE PERSONNEL



**ATTENTION**

RISQUE D'ELECTROCUTION  
NE PAS OUVRIR



ATTENTION: POUR EVITER TOUT RISQUE D'ELECTROCUTION NE PAS OUVRIR LE BOITIER. AUCUNE PIECE INTERIEURE N'EST A REGLER PAR L'UTILISATEUR. SE REFERER A UN AGENT QUALIFIE EN CAS DE PROBLEME.

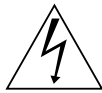

The lightning flash with arrowhead symbol, within an equilateral triangle, is intended to alert the user to the presence of uninsulated "dangerous voltage" within the product's enclosure that may be of sufficient magnitude to constitute a risk of electric shock to persons.



The exclamation point within an equilateral triangle is intended to alert the user to the presence of important operating and maintenance (servicing) instructions in the literature accompanying the appliance.

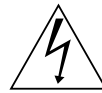

Le symbole de l'éclair à l'intérieur d'un triangle équilatéral est destiné à alerter l'utilisateur sur la présence d'une "tension dangereuse" non isolée dans le boîtier du produit. Cette tension est suffisante pour provoquer l'électrocution de personnes.



Le point d'exclamation à l'intérieur d'un triangle équilatéral est destiné à alerter l'utilisateur sur la présence d'opérations d'entretien importantes au sujet desquelles des renseignements se trouvent dans le manuel d'instructions.

\*Ces symboles ne sont utilisés qu'aux Etats-Unis.

**WARNING:**  
TO REDUCE THE RISK OF FIRE OR ELECTRIC SHOCK, DO NOT EXPOSE THIS APPLIANCE TO RAIN OR MOISTURE.  
This unit should be used with 120 V AC only.  
**CAUTION:**  
To prevent electric shocks and fire hazards, DO NOT use any other power source.

**NOTE:**  
The rating plate (serial number plate) is on the rear of the unit.

**INFORMATION for USA**  
This equipment has been tested and found to comply with the limits for a Class A digital device, pursuant to Part 15 of the FCC Rules. These limits are designed to provide reasonable protection against harmful interference when the equipment is operated in a commercial environment. This equipment generates, uses, and can radiate radio frequency energy and, if not installed and used in accordance with the instruction manual, may cause harmful interference to radio communications. Operation of this equipment in a residential area is likely to cause harmful interference in which case the user will be required to correct the interference at his own expense.

**CAUTION**  
CHANGES OR MODIFICATIONS NOT APPROVED BY JVC COULD VOID USER'S AUTHORITY TO OPERATE THE EQUIPMENT.

THIS DEVICE COMPLIES WITH PART 15 OF THE FCC RULES. OPERATION IS SUBJECT TO THE FOLLOWING TWO CONDITIONS: (1) THIS DEVICE MAY NOT CAUSE HARMFUL INTERFERENCE, AND (2) THIS DEVICE MUST ACCEPT ANY INTERFERENCE RECEIVED, INCLUDING INTERFERENCE THAT MAY CAUSE UNDESIRE OPERATION.

**INFORMATION for Canada**  
This Class A digital apparatus meets all requirements of the Canadian Interference-Causing Equipment Regulations. Cet appareil numérique de la classe A respecte toutes les exigences du Règlement sur le matériel brouilleur de Canada.

**AVERTISSEMENT:**  
POUR EVITER LES RISQUES D'INCENDIE OU D'ELECTROCUTION, NE PAS EXPOSER L'APPAREIL A L'HUMIDITE OU A LA PLUIE.  
Ce magnétoscope ne doit être utilisé que sur du courant alternatif en 120 V.  
**ATTENTION:**  
Afin d'éviter tout resque d'incendie ou d'électrocution, ne pas utiliser d'autres sources d'alimentation électrique.

**REMARQUE:**  
La plaque d'identification (numéro de série) se trouve sur le panneau arrière de l'appareil.

**WARNING:**  
The battery used in the DM-JV600U must be replaced by a JVC authorized service dealer only.

**CAUTION**  
Use of controls or adjustments or performance of procedures other than those specified herein may result in hazardous radiation exposure.

**Note**  
Place a cover on the terminal not in use. Static may cause a malfunction or failure of the unit.

---

**Thank you for purchasing this  
HDTV ENCODER DM-JV600U.**

---

## Main Features

### ● Encoded to MPEG-2(ISO/IEC13818-2)

Input SMPTE292M(1080i/720p) standard HDTV digital serial video signal, encode it to MPEG-2(ISO/IEC13818-2) and output as DVB-ASI TS(Transport Stream).

### ● Supports SDI embedded Audio signal 2 channels

Encodes SMPTE299M standard SDI embedded Audio signal 2 channels to MPEG-1 Layer II (ISO/IEC11172-3) and output as TS format.

### ● Dolby™ Digital (AC-3) pass through Compliance

When Dolby™ Digital bitstream is applied to [AES/EBU] terminal, TS Format output could be obtained as this equipment is Dolby™ Digital (AC-3) 1-5.1 channel pass through compliant.

In addition, when PCM signal is applied to [AES/EBU] terminal, it is possible to encode with MPEG-1 Layer II.

### ● Equipped with RS-232C terminal

Each feature can be set or operated on the front panel with FL display. Besides, this unit can be remote-controlled through the 9-pin connector on the rear panel.

### ● 1U EIA size can be mounted to the rack

Owing to the compact size design, it can be mounted to the EIA rack.

### ● 3-2 Pull down feature

By converting to the SMPTE292M (1080i/720p) standard HDTV digital serial video signal, input movie film image that is 24 frame per one second can also be compressed to high quality using 3-2 Pull down feature.

### ● Equipped with ASI output terminal

Video recording is possible by connecting to D-VHS digital video recorder from JVC that is equipped with ASI input terminal.

If should be noted that it may be unlawful to re-record pre-recorded tapes, records, or discs without the consent of the owner of copyright in the sound or video recording, broadcast or cable program and in any literary, dramatic musical, or artistic work embodied therein.

Prior to important video/ audio recording, always perform a test recording to confirm that video/ audio is properly recorded.

Please note that we will not provide compensation for contents of video/ audio recording due to improper video/ audio recording caused by defects when using this equipment.

Dolby is a trademark of Dolby Laboratories.

# Table of Contents

<b>Introduction</b>	Main Features ..... 4 Table of Contents ..... 5 Precautions ..... 6
<b>Names and Functions</b>	Front Panel ..... 7 Rear Panel ..... 8
<b>Preparation</b>	Connecting ..... 9 Mounting to a Rack ..... 10
<b>Menu setting</b>	Menu Flow Chart ..... 11 Menu Setting ..... 12
<b>Basic operation</b>	How to Change Menu Setting ..... 16 Restoring the Default Menu Setting Value ..... 17 Starting the Encoding ..... 18 Checking Operation Status ..... 20 Checking Error Log ..... 21 Using the Administration Menu ..... 22
<b>Others</b>	Error Log ..... 24 Setting the 3-2 Pulldown ..... 26 Specifications ..... 27

# Precautions

## Maintenance and operating environment

---

- Do not store or use this equipment in the following environments. This will cause malfunctioning and damage.
  - Locations beyond the allowable operating temperature range of 5 °C and 40 °C.
  - Locations beyond the allowable operating humidity level of 30 % and 80 %.
  - Near equipment that produces strong magnetic fields, such as transformers or motors.
  - Near equipment that emits radio waves, such as transceivers and mobile phones.
  - Locations with excessive dust and sand.
  - Locations that are subject to excessive vibration.
  - Locations prone to condensation.
  - Locations that emit radiation, X-rays or corrosive gases.

## Handling

---

- Do not stack up the equipment to prevent temperature within from rising.
- Do not stand this equipment vertically during use.
- Handle this equipment with care. Do not subject it to physical shock.
- Do not place heavy objects or ride on this equipment.

Placing heavy object such as TV monitor or placing bigger object than this unit may cause injury as the object may become unbalanced and fall.

In addition, the cover may deform due to the weight and the component inside may damage resulting in fire and electrical shock.
- Wipe this equipment using soft rags.

Wiping with thinner or benzene may dissolve or tarnish its surface. For dirt that cannot be easily removed, wipe using a neutral detergent diluted with water, followed by wiping with a dry cloth.
- Do not place object filled with water (vase, flowerpot, cup, cosmetics and medicine etc).

It will result in fire and electrical shock if water is spilt into the equipment.
- Do not insert anything into the equipment. It will result in fire and electrical shock if metal or inflammable object is inserted from the ventilation hole.

## Transportation

---

- Turn off the power and unplug the power cord from AC outlet before transportation.

This may cause damage to power cord, fire or electrical shock.
- **When moving or carrying the main unit, do not hold it by the front panel as this can easily be detached by pulling it toward you.**

If moving or carrying the main unit while holding it by the front panel, the main unit might be caused to fall as a result of the front panel becoming detached. Such an incident may cause unexpected injury or a malfunction of the main unit.

## Saving Energy

---

- Turn off the power to save energy when the equipment is not to be used for extensive periods of time.

## Fan Replacement

---

Fans mounted on the inner side of front panel and rear panel are subject to wear and tear. Replace them every 3 years. It is recommended to fill in the provided label with replacement date and paste it on this unit. Consult your local JVC dealer when replacing fan.

## Power Cord

---

- Do not use the power cord supplied with this equipment on other devices.
- **Do not place heavy object on the power cord nor placing the power cord under this unit.**

This may cause damage to power cord, fire or electrical shock.
- **Use the power cord supplied to this unit.**

Using the power cord with different voltage rating or damaged power cord may cause fire or electrical shock.

## Precautions on operation

---

- The display of this unit may appear 2 seconds after turning on the power. This is compliant to the regulation of high frequency of power supply and is not faulty.

# Front Panel

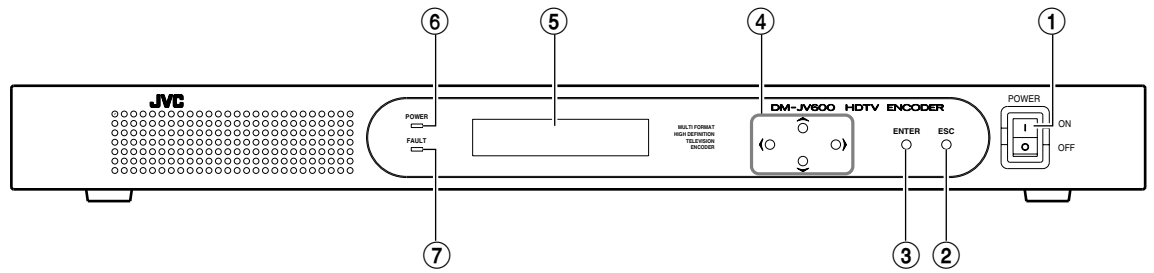

## ① [POWER] Power switch

Switch to turn on/off power. After this is switched to ON, a "Now Initializing" will be displayed on the Display ⑤ of front panel before normal screen is displayed.

**Memo** After turning on the power, it may take 2 seconds before display light up.

## ② [ESC] button

Press this button when switching Display ⑤ on the front panel from menu setting display to normal display. Changing of the setting value in Menu item can also be cancelled by this button.

## ③ [ENTER] button

Press this button when switching Display ⑤ on the front panel from normal display to menu setting display. Changing of the setting value in Menu item can also be confirmed by this button.

**Memo** Refer to page 16 for changing the menu.

## ④ [▲ / ▼ / ◀ / ▶] buttons

Press this button to select menu item or change the setting value of menu item during menu setting display.

## ⑤ Display

The operation status, error content and menu item of this unit will be displayed.  
 Following item "About display"

## ⑥ [POWER] indicator

Light up in green during operation.

## ⑦ [FAULT] indicator

Light up in orange when error occurs on this unit.

### About Display

#### ■ Normal display



Press the ▲ / ▼ buttons

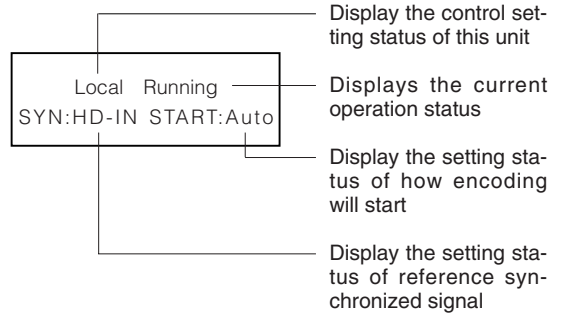

Press the ▲ / ▼ buttons

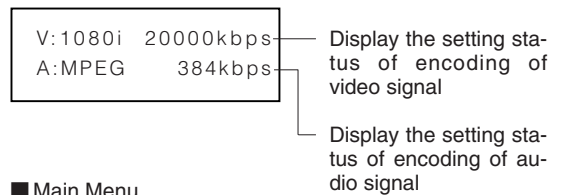

#### ■ Main Menu



Indicate that sub menu is present

#### ■ Sub Menu



Indicate executable menu items or alterable menu setting value



Indicate that sub menu is not present

# Rear Panel

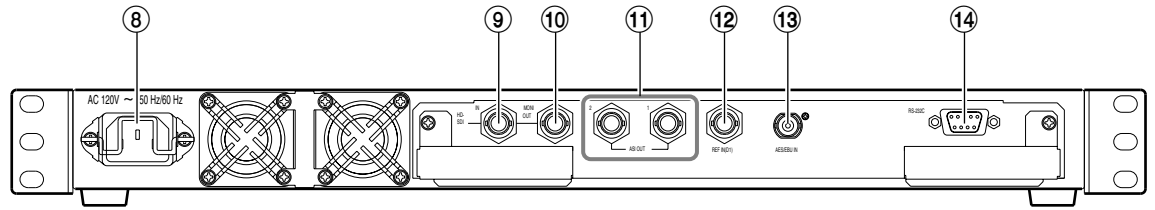

## ⑧ [AC IN] Power input terminal

Use the power cord supplied to connect to an AC 120 V 50 Hz/60 Hz outlet.

## ⑨ [HD-SDI IN] Video signal input terminal (BNC)

Input terminal for HD serial digital video signal. This terminal also receives audio signal when audio signal is embedded into HD serial digital video signal.

Connect to the HD serial digital video signal output terminal of the device outputting video signal.

## ⑩ [HD-SDI MONI OUT] Video signal output terminal (BNC)

Output terminal for through HDTV serial digital video signal.

For checking the video signal inputted into HD-SDI IN video signal input terminal ⑨ on the rear panel.

**Memo** The output signal of HD-SDI MONI.OUT terminal that has not gone through re-clock process cannot be used as a formal SMPTE292M (1080i/720p) standard HDTV serial digital video signal.

## ⑪ [ASI OUT] TS output terminal (BNC x2)

TS output terminal. Encodes and outputs the video signal inputted into HD-SDI IN video signal input terminal ⑨ and the audio signal inputted into AES/EBU IN terminal ⑬.

This terminal also outputs encoded audio signal when audio signal is embedded into HD serial digital video signal.

## ⑫ [REF IN (D1)] External reference synchronized signal input terminal (BNC)

Input external reference synchronized signal. For reference synchronized signal, use the signal that is compliant to SMPTE259M (D1).

**Memo** When using the external reference synchronized signal input terminal, set the Sync Mode item in the Configuration Menu to "REF".  
 Page 13 "Configuration Menu"

- Caution**
- When using the external reference synchronized signal, keep the phase difference of external reference synchronized signal and input video signal within  $\pm 5H$  (1H: D1 signal cycle). (Phase zero is defined when the fourth pin of D1 signal matches with first pin of input video signal.)
  - Input D1 signal before turning on the power of this unit. The encoding may not start if D1 signal is not input when the power of this unit is turned on.

## ⑬ [AES/EBU IN] Audio signal input terminal (BNC)

Input terminal for digital audio signal (PCM or Dolby™ Digital bitstream). Connect to the digital audio signal output terminal of the device outputting audio signal.

**Memo** When using the audio signal input terminal, set the audio input item in the Configuration Menu to "AES/EBU".

Page 13 "Configuration Menu"

- Caution**
- For the audio signal to be input to AES/EBU IN terminal, use the 48 kHz audio signal that is synchronized with video signal.
  - If Dolby™ Digital bitstream is inputted when the Audio Format under the Initial Param Menu is set as "MPEG", loud sound might be produced. Make sure that "DD-PT" is set before inputting Dolby™ Digital bitstream.

## ⑭ [RS-232C] Remote terminal (D-sub 9pin)

By connecting to the device for remote control, control of this unit can be performed externally.

### ■ Pin assignment of RS-232C remote terminal

Pin No.	Signal name	Content
1	N.C	
2	RxD	Received data
3	TxD	Transmitted data
4	N.C	
5	SG	Ground
6	N.C	
7	N.C	
8	N.C	
9	N.C	

  

Transfer speed	38.4 kbps
Data bit	8 bit
Parity	None
StopBit	1 bit
Flow Control	None



# Connecting

One example of the basic systems using this unit is described below.  
Turn OFF the power of all devices before connecting or disconnecting.

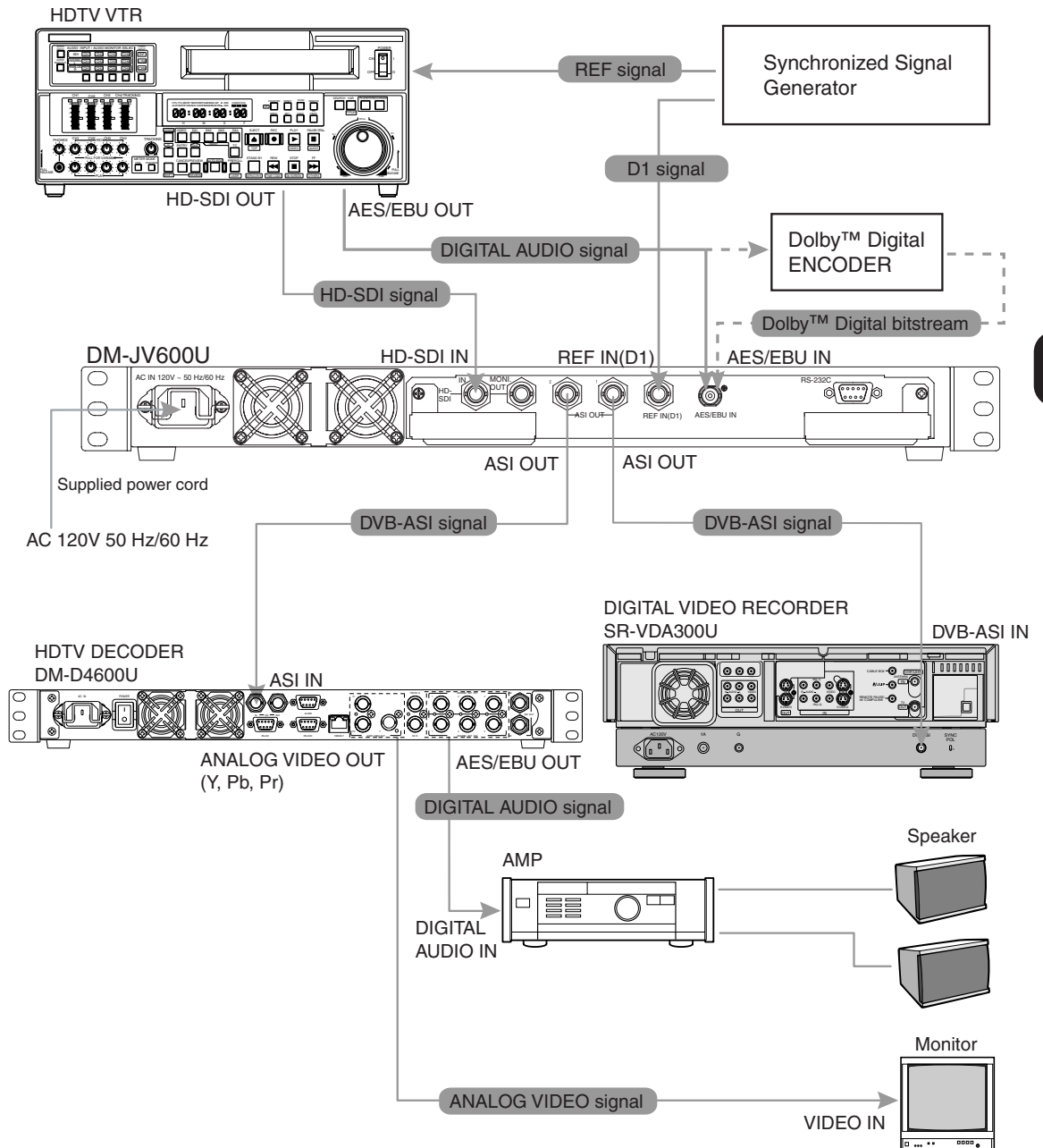

Preparation



If there is interruption of input signal due to switching of HD-SDI input signal or reconnection of signal cable, video or audio signal may not output for about 20 seconds.

When [AES/EBU] terminal is set and used as Audio Input (Page 13) terminal under the Initial Param Menu screen, noise may be introduced into the audio signals if [REF IN] and [HD-SDI IN] are stopped halfway. In addition, when the Dolby™ Digital bitstream is inputted from devices such as DVD player that is not synchronized externally, audio signal might be mixed with noise.

Use the following specified cables to avoid misoperation.

- HD-SDI input cable : 5C-FB, less than 10 m
- HD-SDI monitor output cable : 5C-FB, less than 3 m

This unit may output a full-screen grey signal depends on the following input signal status.

- When the input video signal that is not compliant to SMPTE292M (1080i/720p) is detected
- If the phase difference against input video signal exceeds the range of  $\pm 5H$  when synchronizing to external signal generator

# Mounting to a Rack

By making use of the hole on inner side of front panel, this unit can be mounted to EIA rack.

## Caution

- When mounting this unit to rack, mount the L shape bracket to both ends of the rack to ensure strength.
- When mounting to the rack, mount it in the way such that this unit will not protrude out from the rack.  
(The depth of the rack should be at least 700 mm)

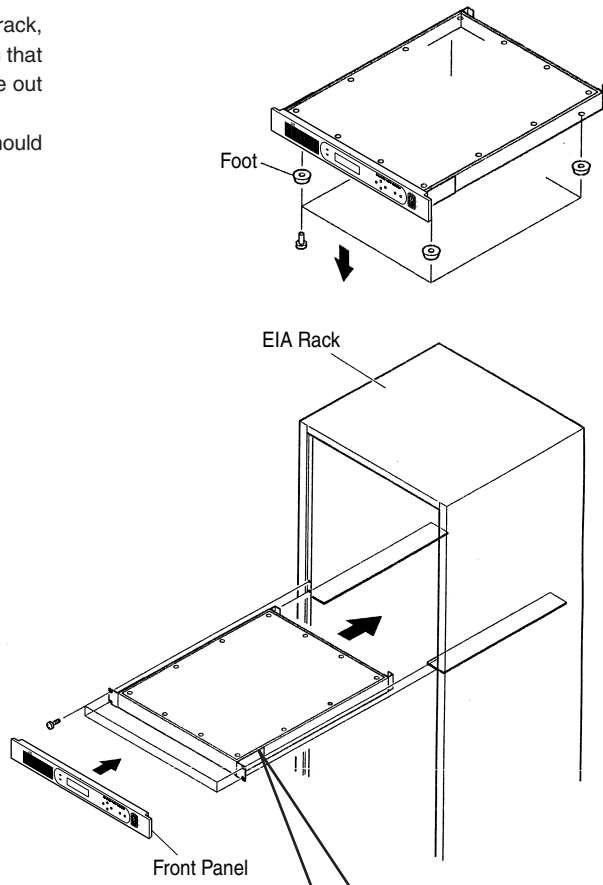

**1** Remove the foot

**2** Remove the front panel

**3** Mount this unit to rack using the supplied 4 screws

**4** Return the front panel to its original status

## Caution

Do not remove the mounting bracket. The mounting may become unstable due to loosen screws. In addition, if the mounting direction of the bracket is wrong, it will be extremely dangerous as the bracket will not be properly mounted onto the rack.

# Menu Flow Chart

The menu of this unit consists of 3 level of menus namely "Main menu", "Sub menu" and "Setting items".

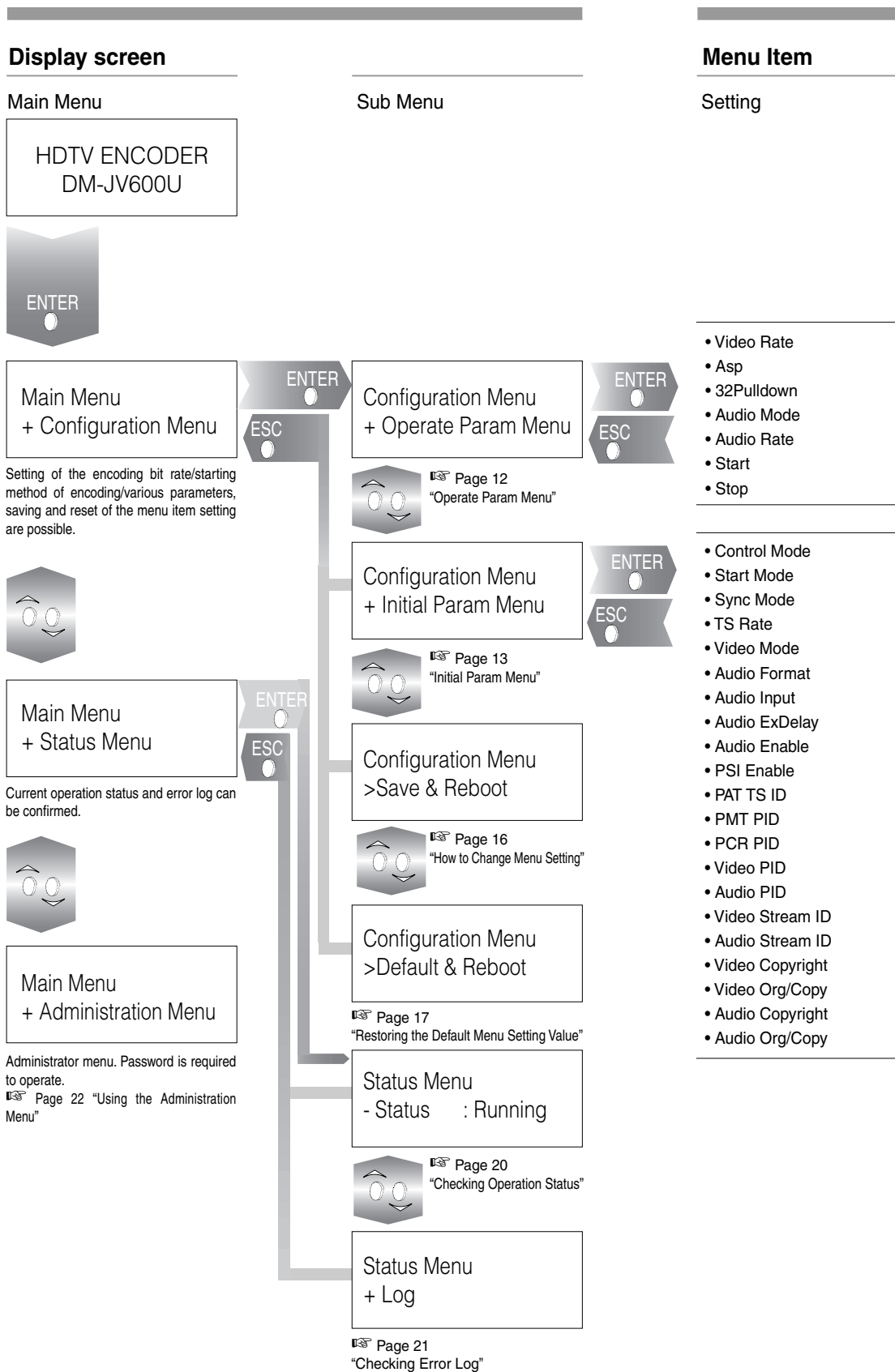

# Menu Setting

## Configuration Menu

● : Default setting

Item	Setting value	Content
Operate Param Menu		
Video Rate	9000kbps to 20000kbps ● to 40000kbps	Set the bit rate of the encoded video signal. The setting value can be set in 10 kbps step.
Asp	<ul style="list-style-type: none"> <li>■ When the Video Mode item in the menu is set to "1080i" <ul style="list-style-type: none"> <li>16:9 1920 × 1080 ●</li> <li>16:9 1440 × 1080</li> <li>16:9 1280 × 1080</li> </ul> </li> <li>■ When the Video Mode item in the menu is set to "720p" <ul style="list-style-type: none"> <li>16:9 1280 × 720</li> </ul> </li> </ul>	Set the horizontal size of the encoded video signal. 16:9 1920 × 1080: Encode with 1920(H) × 1080(V) size 16:9 1440 × 1080: Encode with 1440(H) × 1080(V) size 16:9 1280 × 1080: Encode with 1280(H) × 1080(V) size 16:9 1280 × 720: Encode with 1280(H) × 720(V) size
3-2Pulldown	Auto ● OFF	Set the 3-2 Pulldown. Auto : Perform 3-2 Pulldown process automatically depends on the video signal. OFF : Does not perform 3-2 Pulldown process. 📖 Page 26 "Setting the 3-2 Pulldown"
Audio Mode	Stereo ● Single	Set the channel mode of the audio encoded signal. Stereo : Encode with stereo mode. Single : Encode with single channel mode (monaural).
Audio Rate	<ul style="list-style-type: none"> <li>■ When the Audio Mode item in the menu is set to "Stereo" <ul style="list-style-type: none"> <li>384kbps ●</li> <li>256kbps</li> <li>192kbps</li> </ul> </li> <li>■ When the Audio Mode item in the menu is set to "Single" <ul style="list-style-type: none"> <li>192kbps</li> <li>128kbps</li> <li>96kbps</li> </ul> </li> </ul>	Set the bit rate of the encoded audio signal.
Start		Start the encoding. 📖 Page 18 "Starting the Encoding"
Stop		Stop the encoding. 📖 Page 19 "Stop the encoding manually"



When the Audio Enable under the Initial Param Menu screen is set to ON, the upper limit value of Video Rate is

When the Audio Format under the Initial Param Menu screen is set as

- MPEG: TS Rate - 700kbps
- DD-PT (Dolby™ Digital Pass Through) : TS Rate - 1000kbps

When Audio Enable is set to OFF,

- TS Rate - 200kbps



• The setting value of the Audio Rate item in the Operate Param Menu may change if Audio Mode setting is changed.

• The setting of Audio Mode and Audio Rate under the Operate Param Menu are disallowed when Audio Format under the Initial Param Menu is set as DD-PT (Dolby™ Digital Pass Through).

## Configuration Menu

● : Default setting

Item	Setting value	Content
Initial Param Menu		
Control Mode	Local ● Remote	Set the operation mode of this unit. Local : Set to this mode when operating this unit using the buttons on the front panel. Remote : Set to this mode when using RS-232C terminal ⑭ on the rear panel to perform remote control of this unit.
Start Mode	Auto ● Manual	Set the starting mode of encoding. Auto : Start the encoding automatically. Manual : Start the encoding using the menu. ☞ Page 18 "Starting the Encoding"
Sync Mode	HD-IN ● REF	Set the synchronized signal that is the reference for encoding. HD-IN : Synchronize with the input video signal. REF : Synchronize with the D1 signal input into REF IN terminal ⑫ on the rear panel.
TS Rate	10000kbps to 21000kbps ● to 50000kbps	Set the TS bit rate. The setting value can be changed in 10 kbps step.
Video Mode	1080i ● 720p	Set the Video Mode. Encode with 1080i: 1080i format. Encode with 720p: 720p format.
Audio Format	MPEG ● DD-PT (Dolby™ Digital Pass Through)	Setting the Audio Format. MPEG : Encoding with MPEG Layer II. DD-PT(Dolby™ Digital Pass Through) : Dolby™ Digital bitstream will be output in TS Format.
Audio Input	AES/EBU ● EMB	Select the input audio signal. AES/EBU : Encode the audio signal input into AES/EBU terminal ⑬ on the rear panel. EMB : Encode the Embedded audio signal input into HD-SDI IN terminal ⑨ on the rear panel.
Audio ExDelay	1ms to 10ms ● to 500ms	This setting is meant for compensating the delays introduced when encoders are connected to external equipment. (Denary, Millisecond unit) Setting value is 1 ms step variable.
Audio Enable	ON ● OFF	Set whether to output audio signal or not. ON : Output audio information. OFF : Does not output audio information.



When input video signal is used in synchronized mode, video signal may not output for about 20 seconds due to switching of signal or reconnection of signal cable.



The setting value of the Video Rate item in the Operate Param Menu may change if TS Rate setting value is changed.



The setting value of the Asp item in the Operate Param Menu may change if Video Mode setting value is changed.



This setting is only valid when Audio Format is set as DD-PT (Dolby™ Digital Pass Through).

# Menu Setting

## Configuration Menu (continued)

● : Default setting

Item	Setting value	Content
Initial Param Menu		
PSI Enable	ON● OFF	Set the PSI (Program Specific Information) to ON/OFF. ON : PAT and PMT will be output. OFF : PAT and PMT will not be output.
PAT TS ID	0001 to 0001● to FFFF	Set the ID of PAT TS. PAT TS ID is the Transport Stream ID within PAT. PAT (Program Association Table) is the correspondences table of Program number and PMT PID.
PMT PID	0010 to 0010● to 1FFE	Set the PMT Packet ID. PMT (Program Map Table) is an index table that designates the various stream PIDs which constituted the program.
PCR PID	0010 to 0101● to 1FFE	Set the PCR Packet ID. PCR (Program Clock Reference) is clock data that is output periodically. It is used by the decoder to synchronize with internal clock for PLL synchronization.
Video PID	0020 to 0102● to 1FFE	Set the Video Packet ID.
Audio PID	0020 to 0103● to 1FFE	Set the Audio Packet ID.
Video Stream ID	E0 to E0● to EF	Set the ID of Video PES stream.

## Configuration Menu (continued)

● : Default setting

Item	Setting value	Content
Initial Param Menu		
Audio Stream ID	C0 to C0● to DF	Set the ID of Audio PES stream.
Video Copyright	OFF● ON	Set the copyright flag of Video PES. OFF : Set the copyright flag of Video PES to OFF. ON : Set the copyright flag of Video PES to ON.
Video Org/Copy	Org● Copy	Set the Original/ Copy of Video PES. Org : Set the Video PES to Original. Copy : Set the Video PES to Copy.
Audio Copyright	OFF● ON	Set the copyright flag of Audio PES. OFF : Set the copyright flag of Audio PES to OFF. ON : Set the copyright flag of Audio PES to ON.
Audio Org/Copy	Org● Copy	Set the Original/ Copy of Audio PES. Org : Set the Audio PES to Original. Copy : Set the Audio PES to Copy.
Save & Reboot		Save the setting value of the menu and restart this unit. 📖 Page 18 "Starting the Encoding"
Default & Reboot		Return the setting value of the menu to default and restart this unit. 📖 Page 17 "Restoring the Default Menu Setting Value"



This setting is disabled when Audio Format under the Initial Param Menu screen is set as DD-PT (Dolby™ Digital Pass Through). (Fixed as 0xBD)

# How to Change Menu Setting

The various features of this unit can be set using the menu. The setting value, which is stored in the internal memory will reappear upon turning on the power.

## ■ Example

Remote control of this unit can be achieved by using the RS-232C terminal on the rear panel.

[Configuration Menu]  
↓  
[Initial Param Menu]  
↓  
[Control Mode]  
↓  
"Remote"

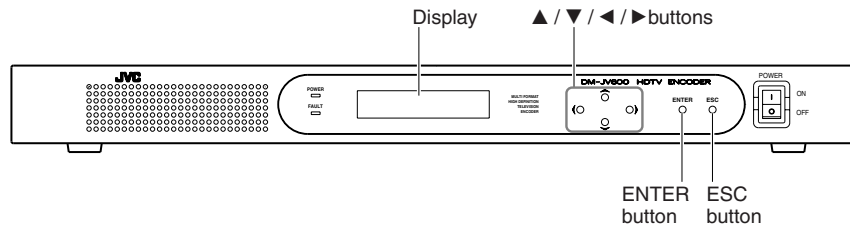

## Operation Flow Chart

- 1 Press the ENTER button**  
Main Menu screen will be displayed.
- 2 Press the ▲ / ▼ buttons**  
Select the Configuration Menu.
- 3 Press the ENTER button**  
Configuration Menu screen will be displayed.
- 4 Press the ▲ / ▼ buttons**  
Select the Initial Param Menu.
- 5 Press the ENTER button**  
Initial Param Menu screen will be displayed.
- 6 Press the ▲ / ▼ buttons**  
Select the Control Mode item and press the ENTER button.
- 7 Press the ▲ / ▼ buttons**  
Select the "Remote" and press the ENTER button.
- 8 Press the ESC button**
- 9 Press the ENTER button**

## Display Flow Chart

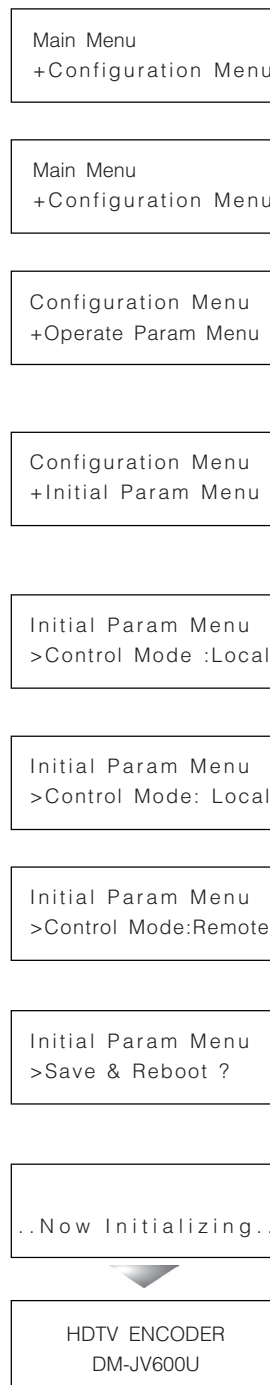

The Operate Param Menu setting will be reflected in the output even if "Save & Reboot" is not executed.



Do not turn off the power switch during "Now Initializing" display. The setting value may not be saved or may return to default setting.



# Restoring the Default Menu Setting Value

Each feature that has been set using the menu can be returned to default (factory setting).  
All the menu settings return to default.

## Operation Flow Chart

- 1 Press the ENTER button**  
Main Menu screen will be displayed.
- 2 Press the ▲ / ▼ buttons**  
Select the Configuration Menu.
- 3 Press the ENTER button**  
Configuration Menu screen will be displayed.
- 4 Press the ▲ / ▼ buttons**  
Select the Default & Reboot.
- 5 Press the ENTER button**  
Execution confirmation screen will be displayed.
- 6 Press the ENTER button**  
Setting to default of the menu setting and reboot of this unit will be performed.

## Display Flow Chart

Main Menu  
+Configuration Menu

Main Menu  
+Configuration Menu

Configuration Menu  
+Operate Param Menu

Configuration Menu  
>Default & Reboot

Configuration Menu  
>Default & Reboot ?

..Now Initializing..

HDTV ENCODER  
DM-JV600U



Do not turn off the power switch during "Now Initializing" display.

# Starting the Encoding

There are 2 ways to start the encoding. One is to start the encoding automatically and the other one is to start it manually by setting the menu.

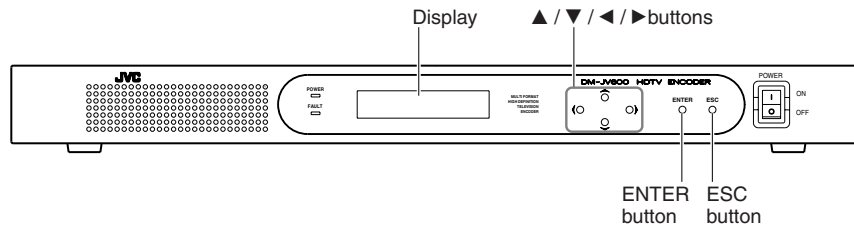

## Start the encoding automatically

### Operation Flow Chart

- 1 Press the ENTER button**  
Display the Initial Param Menu screen according to steps 1~5 on Page 16 "How to Change Menu Setting".
- 2 Press the ▲ / ▼ buttons**  
Select the Start Mode item and press the ENTER button.
- 3 Press the ▲ / ▼ buttons**  
Select the "Auto" and press the ENTER button.
- 4 Press the ESC button**
- 5 Press the ENTER button**  
The encoding will start after the menu setting is saved and reboot of this unit is performed.

### Display Flow Chart

Initial Param Menu  
>Control Mode :Local

Initial Param Menu  
>Start Mode :Auto

Initial Param Menu  
>Start Mode :Auto

Initial Param Menu  
>Save & Reboot ?

..Now Initializing..

HDTV ENCODER  
DM-JV600U



The default setting of the Start Mode item is set to "Auto" in order to start the encoding automatically.

☞ Page 13 "Start Mode item"



The encoding can be manually started or stopped if the Start Mode item in the menu is set to "Manual".

☞ Page 19 "Start the encoding manually"

■ Set the Start Mode item in the menu to “Manual” according to the procedure on Page 18 “Start the encoding automatically”.

## Start the encoding manually

### Operation Flow Chart

- 1 Press the ENTER button**  
Main Menu screen will be displayed.
- 2 Press the ▲ / ▼ buttons**  
Select the Configuration Menu and press the ENTER button.
- 3 Press the ▲ / ▼ buttons**  
Select the Operate Param Menu and press the ENTER button.
- 4 Press the ▲ / ▼ buttons**  
Select the Start item and press the ENTER button.
- 5 Press the ENTER button**  
This starts the encoding.

### Display Flow Chart

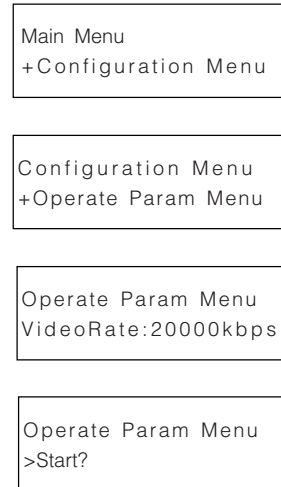

The encoding will stop if menu item has been changed during manual encoding and “>Save&Reboot” has been executed. Start the encoding manually once again.

## Stop the encoding manually

### Operation Flow Chart

- 1 Press the ENTER button**  
Main Menu screen will be displayed.
- 2 Press the ▲ / ▼ buttons**  
Select the Configuration Menu and press the ENTER button.
- 3 Press the ▲ / ▼ buttons**  
Select the Operate Param Menu and press the ENTER button.
- 4 Press the ▲ / ▼ buttons**  
Select the Stop item and press the ENTER button.
- 5 Press the ENTER button**  
Stop the encoding.

### Display Flow Chart

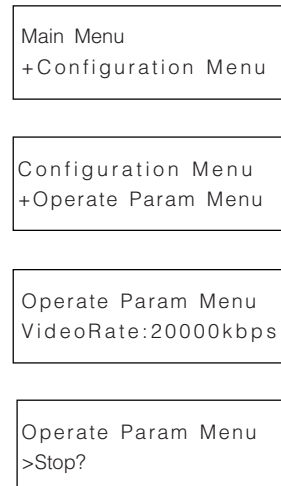

# Checking Operation Status

The operation status of this unit can be confirmed from the display.

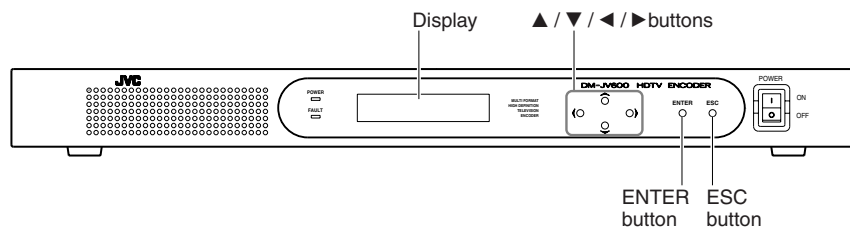

## Operation Flow Chart

- 1 Press the ENTER button**  
Main Menu screen will be displayed.
- 2 Press the ▲ / ▼ buttons**  
Select the Status Menu.
- 3 Press the ENTER button**  
Status Menu screen will be displayed.
- 4 Press the ▲ / ▼ buttons**  
Current operation status will be displayed by selecting the Status item.

## Display Flow Chart

Main Menu +Configuration Menu
Main Menu +Status Menu
Status Menu -Status :Running
Status Menu -Status :Running
Status Menu -Status :Running
Status Menu -Status :Ready
Status Menu -Status :Fatalerror



Indicate that the encoding is in process.

Indicate that the encoding is in standby status.

Indicates that fatal error has occurred.  
 Page 24 "Error Log"

# Checking Error Log

The error occurrence can be confirmed on the display. Up to 64 occurrences can be stored.

## Operation Flow Chart

- 1 Press the ENTER button**  
Main Menu screen will be displayed.
- 2 Press the ▲ / ▼ buttons**  
Select the Status Menu.
- 3 Press the ENTER button**  
Status Menu screen will be displayed.
- 4 Press the ▲ / ▼ buttons**  
Select the Log item and press the ENTER button.
- 5 Press the ▲ / ▼ buttons**  
The error log stored will be displayed.  
For detailed error log display, read page 24 "Error log".

## Display Flow Chart

Main Menu  
+Configuration Menu

Main Menu  
+Status Menu

Status Menu  
-Status :Running

Status Menu  
+Log

00:Feb07 14:06 0001  
-system boot

# Using the Administration Menu

The information regarding built-in program or firmware version can be obtained from the Administration Menu. In addition, clock setting and the display brightness could be adjusted.

\* Please carry out the clock setting before use.

■ Examples of setting  
Setting the clock using the Administration Menu screen.

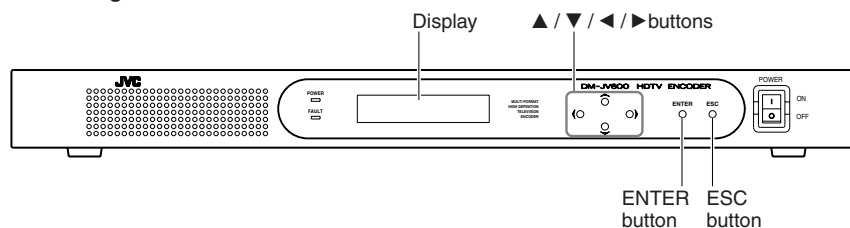

## Operation Flow Chart

- 1 Press the ENTER button**  
Main Menu screen will be displayed.
- 2 Press the ▲ / ▼ buttons**  
Select the Administration Menu.
- 3 Press the ENTER button**  
The Administration Menu screen will be displayed.
- 4 Press the ▲ / ▼ buttons**  
Choose the Time item and press ENTER button.
- 5 Press the ▲ / ▼ / ◀ / ▶ Buttons**
  - ◀ / ▶ Buttons : Move the cursor to the highlight the places when changes are to be made.
  - ▲ / ▼ Buttons : Change the values highlighted by the cursor.

Press the [ENTER] button once changes are made.

## Display Flow Chart

Main Menu  
+Configuration Menu

Main Menu  
+Administration Menu

Administration Menu  
-Model :DM-JV600U

Administration Menu  
>Time : 04/03/19 22:00

Administration Menu  
>Time : 04/03/19 22:00 ■

At the selected places,  
cursor will start to blink.

## **Administration menu**

<b>Item</b>	<b>Content</b>
Model	Displays the model name.
SerNo	Displays the serial number.
Time	Setting the Clock. Year/Month/Day Hour : Minute (For the Year setting, only the last 2 digits of the year will be used)
FL Brightness (Initial Setting: 0)	Setting the Display brightness. Setting range is between 0 to 3. 0 : Brightest setting.
Firm	Displays the firmware version.
Ucode	Displays the version of the $\mu$ code.
Boot	Displays the version of boot program.
MISC FPGA	Displays the version of MISC FPGA.
STC FPGA	Displays the version of STC FPGA.
I/O PWB	Displays the version of I/O PWB.
I/O VI PLD	Displays the version of I/O VI PLD.
I/O AU PLD	Displays the version of I/O AU PLD.

# Error Log

The stored error log can be displayed by performing the operation on page 21 “Checking Error Log”.  
The error content is displayed by error code.

## Display

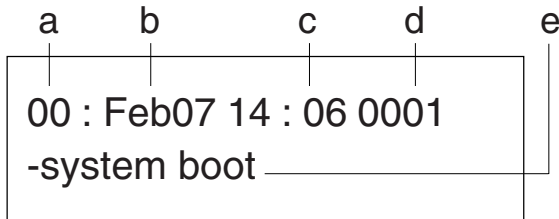

- a: Error log No.
- b: Error occurrence date
- c: Error occurrence time
- d: Error code
- e: Error content

\* For the error content with plenty of characters, press the ◀ / ▶ buttons to scroll the display.

\* The date and hour of this unit is adjusted to Greenwich Mean Time (GMT).

## Error code

Error code:Error content	Cause of error	Troubleshooting
0001: system boot	Restart of this unit has been performed.	
0020: communication error	The communication error caused by control device communication has occurred.	Confirm the connection to external device. Confirm the setting of external device.
0021: command parameter error	The value of command and parameter created by control device communication is abnormal.	
0022: command busy	This unit has received action command when it is busy.	
0040: sync input error	The synchronized signal cannot be detected.	Confirm the connection to external synchronized signal generator and the synchronized signal itself.
0041: sync input error recover		
0050: sync no input timeout error	The detection of the synchronized signal has timed out when this unit restarts.	
0080: enc hardware video input error	The video input signal is abnormal.	Confirm the connection between HD-SDI IN terminal and connected device.
0081: enc hardware video input error recover		Confirm the signal input into HD-SDI IN terminal
0084: enc hardware audio input error	The audio input signal is abnormal.	Confirm the connection between AES/EBU IN terminal and connected device.
0085: enc hardware audio input error recover		Confirm the signal input into AES/EBU IN terminal.
0088: enc hardware resync	Resync process has occurred when synchronizing to video input signal.	Confirm the connection between HD-SDI IN terminal and connected device(Frequent reconnection of the connector may cause the error). Confirm the signal input into HD-SDI IN terminal.



## Error code

Error code:Error content	Cause of error	Troubleshooting
0002: parameter error	The content of the internal parameter (default parameter and others) is abnormal.	This unit is abnormal. Switch the power to "OFF" and turn on the power again. Consult your local JVC dealer if the problem is still unsolved.
0008: FAN stop error	FAN operation is abnormal.	
0009: FAN stop error recover		
001a: FAN stop timeout error		
0013: hardware fatal error	The hardware of this unit is abnormal.	
0014: software fatal error	The software of this unit is abnormal.	
0015: system boot fatal error	The restart of this unit is abnormal.	
0044: video frame interrupt timeout error	The interruption of video frame has timed out.	
0045: video frame interrupt timeout error recover		
0060: domino chip running error	The IC inside this unit is abnormal.	
0061: domino chip running error recover		
0072: domino chip boot fatal error		
0073: domino chip running fatal error		
00a0: enc software video input error	The process of the input stage of video signal is abnormal.	
00a1: enc software video input error recover		
00a2: enc software video running error		
00a3: enc software video running error recover		
00a8: enc software audio input error	The process of the input stage of audio signal is abnormal.	
00a9: enc software audio input error recover		
00aa: enc software audio running error		
00ab: enc software audio running error recover		

# Setting the 3-2 Pulldown

## Encoding image film material

It is required to convert the video signal (Pull-down) in order to view the image recorded with 24 frames per second such as movie film on a system for HDTV video signal that is 30 frames per second (60 field) used in TV broadcasting. Normally, HDTV VTR utilize 3 - 2 Pull-down (Telecine) method to achieve image signal conversion before recording on tape. When this equipment is encoding signals which have been recorded with 3 - 2 Pull-down processing, it is possible to encode by automatically skip 24 frames in order to increase compression ratio. (Inverse Telecine)

## 3-2 Pull-down auto setting

For 3-2 Pull-down method, the odd number frame is converted to 2 fields and the even number frame is converted to 3 fields. With this feature, it is possible to convert 2 frames into 5 fields which means that 24 frames could be converted into 60 fields.

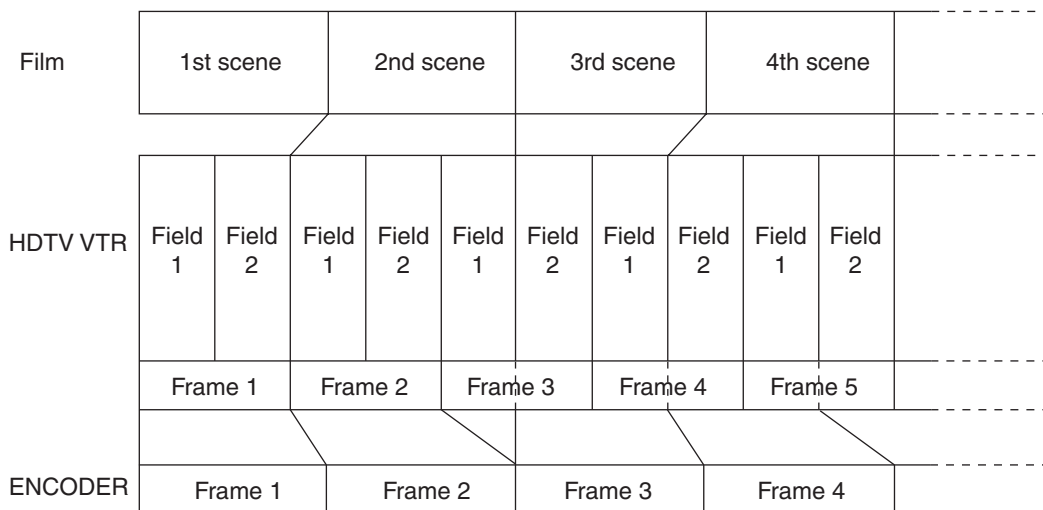

When 3-2 Pull-down under the Operate Param Menu is set to AUTO, input image signals will automatically be detected for 3-2 Pull-down processing information, unnecessary fields will be discarded and only the original 24 frames will be encoded.

# Specifications

## <Input signal>

<ul style="list-style-type: none"> <li>■ Video input HD SDI IN x1</li> </ul>	<ul style="list-style-type: none"> <li>SMPTE292M (common for 1080i/720p)</li> <li>SMPTE299M (Embedded Audio)</li> <li>800 mVp-p, 75 Ω (BNC unbalanced)</li> <li>1080i:1920 × 1080 frame frequency 29.97Hz</li> <li>720p:1280 × 720 frame frequency 59.94Hz</li> </ul>
<ul style="list-style-type: none"> <li>■ Audio input AES/EBU IN x1</li> </ul>	<ul style="list-style-type: none"> <li>AES/EBU</li> <li>(48 kHz sampling frequency synchronized with video signal)</li> <li>1 Vp-p, 75 Ω (BNC unbalanced)</li> </ul>
<ul style="list-style-type: none"> <li>■ Synchronized input REF IN x1</li> </ul>	<ul style="list-style-type: none"> <li>SMPTE259M</li> <li>800 mVp-p, 75 Ω (BNC unbalanced)</li> </ul>

## <Output signal>

<ul style="list-style-type: none"> <li>■ Video output MONITOR OUT x1</li> </ul>	<ul style="list-style-type: none"> <li>SMPTE292M(common for 1080i/720p)</li> <li>800 mVp-p, 75 Ω (BNC unbalanced)</li> </ul>
<ul style="list-style-type: none"> <li>ASI OUT x2</li> </ul>	<ul style="list-style-type: none"> <li>DVB/ASI(188byte format,packet mode)</li> <li>800 mVp-p, 75 Ω (BNC unbalanced)</li> </ul>

## <Video encoding>

MPEG-2 (ISO/IEC13818-2)	Video encoding profile	Video bit rate
	1080i MP@HL 1920 × 1080 59.94 Hz	9Mbps~40 Mbps
	1080i MP@HL 1440 × 1080 59.94 Hz	9Mbps~40 Mbps
	1080i MP@HL 1280 × 1080 59.94 Hz	9Mbps~40 Mbps
	720p MP@H14L 1280 × 720 59.94 Hz	9Mbps~40 Mbps

## <Audio encoding>

MPEG-1 Layer II (ISO/IEC11172-3)	● Stereo mode	● Single mode
Bit rate	384 kbps	Bit rate 192 kbps
	256 kbps	128 kbps
	192 kbps	96 kbps
Sampling	48 kHz	Sampling 48 kHz

Dolby™ Digital(AC-3) Pass Through	Channel : 1-5.1 channel
	Sampling : 48 kHz
	Bit rate : 56 kbps to 640 kbps

## <General>

■ Interface	RS-232C x1
■ Power supply	AC 120 V 50 Hz/60 Hz
■ Power consumption	70 W , 0.6 A
■ Allowable operating temperature	5 °C to 40 °C
■ Allowable storage temperature	-20 °C to 60 °C
■ Allowable operating humidity	30 % to 80 %
■ Mass	Approx. 10 kg

## <Accessories>

■ Instruction Manual .....	x1
■ Power cord (2.4 m) .....	x1
■ Screws for mounting rack ...	x4
■ Label .....	x1

## <Appearance>

[unit : mm]

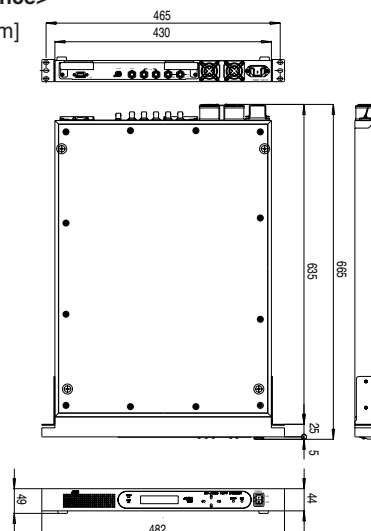

\*Dolby is a trademark of Dolby Laboratories.

\*Specifications and appearance of this unit are subject to change for improvement without prior notice.  
Download from [www.somanuals.com](http://www.somanuals.com). All Manuals Search And Download.



VICTOR COMPANY OF JAPAN, LIMITED

**JVC** is a registered trademark owned by VICTOR COMPANY OF JAPAN, LTD.

**JVC** is a registered trademark in Japan, the U.S.A., the U.K. and many other countries.

© 2004 VICTOR COMPANY OF JAPAN, LIMITED

## Free Manuals Download Website

<http://myh66.com>

<http://usermanuals.us>

<http://www.somanuals.com>

<http://www.4manuals.cc>

<http://www.manual-lib.com>

<http://www.404manual.com>

<http://www.luxmanual.com>

<http://aubethermostatmanual.com>

Golf course search by state

<http://golfingnear.com>

Email search by domain

<http://emailbydomain.com>

Auto manuals search

<http://auto.somanuals.com>

TV manuals search

<http://tv.somanuals.com>