

JVC®

U I E JVC®

VIDEO CASSETTE RECORDER BR-DV600U INSTRUCTIONS

Mini DV

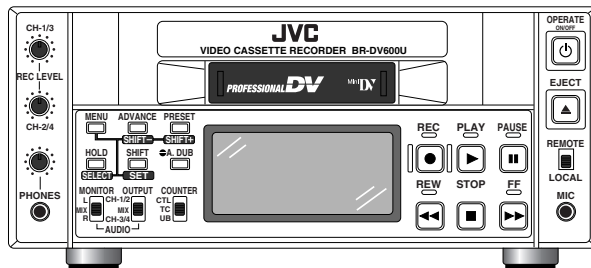

Thank you for purchasing this JVC product. Before operating this unit, please read the instructions carefully to ensure the best possible performance.

This instruction book is made from 100% recycled paper.

For Customer Use:
Enter below the Serial No. which is located on the bottom of cabinet. Retain this information for future reference.

Model No. BR-DV600U

Serial No. _____

SL96179

VIDEO CASSETTE RECORDER BR-DV600E INSTRUCTIONS

Mini DV

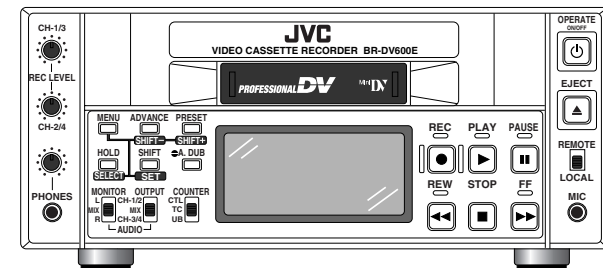

Thank you for purchasing this JVC product. Before operating this unit, please read the instructions carefully to ensure the best possible performance.

This instruction book is made from 100% recycled paper.

SL96180

IMPORTANT SAFEGUARDS

1. Read all of these instructions.
2. Save these instructions for later use.
3. All warnings on the product and in the operating instructions should be adhered to.
4. Unplug this appliance system from the wall outlet before cleaning. Do not use liquid cleaners or aerosol cleaners. Use a damp cloth for cleaning.
5. Do not use attachments not recommended by the appliance manufacturer as they may cause hazards.
6. Do not use this appliance near water – for example, near a bathtub, washbowl, kitchen sink, or laundry tub, in a wet basement, or near a swimming pool, etc.
7. Do not place this appliance on an unstable cart, stand, or table. The appliance may fall, causing serious injury to a child or adult, and serious damage to the appliance. Use only with a cart or stand recommended by the manufacturer, or sold with the appliance. Wall or shelf mounting should follow the manufacturer's instructions, and should use a mounting kit approved by the manufacturer. An appliance and cart combination should be moved with care. Quick stops, excessive force, and uneven surfaces may cause the appliance and cart combination to overturn.
8. Slots and openings in the cabinet and the back or bottom are provided for ventilation, and to insure reliable operation of the appliance and to protect it from overheating, these openings must not be blocked or covered. The openings should never be blocked by placing the appliance on a bed, sofa, rug, or other similar surface. This appliance should never be placed near or over a radiator or heat register. This appliance should not be placed in a built-in installation such as a bookcase unless proper ventilation is provided.
9. This appliance should be operated only from the type of power source indicated on the marking label. If you are not sure of the type of power supplied to your home, consult your dealer or local power company. For appliance designed to operate from battery power, refer to the operating instructions.
10. This appliance system is equipped with a 3-wire grounding type plug (a plug having a third (grounding) pin). This plug will only fit into a grounding-type power outlet. This is a safety feature. If you are unable to insert the plug into the outlet, contact your electrician to replace your obsolete outlet. Do not defeat the safety purpose of the grounding plug.
11. For added protection for this product during a lightning storm, or when it is left unattended and unused for long periods of time, unplug it from the wall outlet and disconnect the antenna or cable system. This will prevent damage to the product due to lightning and power-line surges.
12. Do not allow anything to rest on the power cord. Do not locate this appliance where the cord will be abused by persons walking on it.
13. Follow all warnings and instructions marked on the appliance.
14. Do not overload wall outlets and extension cords as this can result in fire or electric shock.
15. Never push objects of any kind into this appliance through cabinet slots as they may touch dangerous voltage points or short out parts that could result in a fire or electric shock. Never spill liquid of any kind on the appliance.
16. Do not attempt to service this appliance yourself as opening or removing covers may expose you to dangerous voltage or other hazards. Refer all servicing to qualified service personnel.
17. Unplug this appliance from the wall outlet and refer servicing to qualified service personnel under the following conditions:
 - a. When the power cord or plug is damaged or frayed.
 - b. If liquid has been spilled into the appliance.
 - c. If the appliance has been exposed to rain or water.
 - d. If the appliance does not operate normally by following the operating instructions. Adjust only those controls that are covered by the operating instructions as improper adjustment of other controls may result in damage and will often require extensive work by a qualified technician to restore the appliance to normal operation.
 - e. If the appliance has been dropped or the cabinet has been damaged.
 - f. When the appliance exhibits a distinct change in performance – this indicates a need for service.
18. When replacement parts are required, be sure the service technician has used replacement parts specified by the manufacturer that have the same characteristics as the original part. Unauthorized substitutions may result in fire, electric shock, or other hazards.
19. Upon completion of any service or repairs to this appliance, ask the service technician to perform routine safety checks to determine that the appliance is in safe operating condition.



Supplement

This equipment is in conformity with the provisions and protection requirements of the corresponding European Directives. This equipment is designed for professional video appliances and can be used in the following environments:

- residential area (in houses)
- commercial and light industry; e.g. office or theatres

This apparatus is designed for rack mounting or is used close to other apparatus.

In order to keep the best performance and furthermore for electromagnetic compatibility we recommend to use cables not exceeding the following lengths:

Port	Cable	Length
LINE IN	Coaxial Cable	10 meters
LINE OUT	Coaxial Cable	10 meters
VIDEO MONITOR OUT	Coaxial Cable	10 meters
COMPONENT Y IN	Coaxial Cable	10 meters
R-Y IN	Coaxial Cable	10 meters
B-Y IN	Coaxial Cable	10 meters
COMPONENT Y OUT	Coaxial Cable	10 meters
R-Y OUT	Coaxial Cable	10 meters
B-Y OUT	Coaxial Cable	10 meters
Y/C IN	Exclusive Cable	10 meters
Y/C OUT	Exclusive Cable	10 meters
SYNC IN	Coaxial Cable	10 meters
(TIMECODE IN)	Coaxial Cable	10 meters
TIMECODE OUT	Coaxial Cable	10 meters
AUDIO IN	Exclusive Cable	10 meters
AUDIO OUT	Exclusive Cable	10 meters
AUDIO MONITOR OUT	Exclusive Cable	10 meters
SERIAL REMOTE	Cable with RM-G30U	3 meters
REMOTE1 (RS-422)	Exclusive Cable	10 meters
REMOTE2 (JVC BUS)	Exclusive Cable	10 meters
DV IN/OUT	Exclusive Cable	5 meters
MIC	Cable with Microphone	5 meters
PHONES	Cable with Headphones	5 meters
AC IN	Exclusive Cable	5 meters
DC 12V	Exclusive Cable	5 meters

The inrush current of this apparatus is 8 amperes.

Caution:

- Where there are strong electromagnetic waves or magnetism, for example near a radio or TV transmitter, transformer, motor, etc., the picture and sound may be disturbed. In such a case, please keep the apparatus away from the sources of the disturbance.
- When the RM-G800U remote controller is used, the counter, etc. may malfunction due to interference generated by the peripheral equipment. In this case, consult your nearest JVC dealer.

SAFETY PRECAUTIONS

CAUTION

RISK OF ELECTRIC SHOCK
DO NOT OPEN

CAUTION: TO REDUCE THE RISK OF ELECTRIC SHOCK,
DO NOT REMOVE COVER (OR BACK).
NO USER-SERVICEABLE PARTS INSIDE.
REFER SERVICING TO QUALIFIED SERVICE PERSONNEL



The lightning flash with arrowhead symbol, within an equilateral triangle, is intended to alert the user to the presence of uninsulated "dangerous voltage" within the product's enclosure that may be of sufficient magnitude to constitute a risk of electric shock to persons.



The exclamation point within an equilateral triangle is intended to alert the user to the presence of important operating and maintenance (servicing) instructions in the literature accompanying the appliance.

WARNING:
TO REDUCE THE RISK OF FIRE OR ELECTRIC SHOCK, DO NOT EXPOSE THIS APPLIANCE TO RAIN OR MOISTURE.

This unit should be used with 120 V AC only.

CAUTION:
To prevent electric shocks and fire hazards, DO NOT use any other power source.

NOTE:

The rating plate (serial number plate) is on the bottom of the unit.

INFORMATION

This equipment has been tested and found to comply with the limits for a Class B digital device, pursuant to Part 15 of the FCC Rules. These limits are designed to provide reasonable protection against harmful interference in a residential installation. This equipment generates, uses, and can radiate radio frequency energy and, if not installed and used in accordance with the instructions, may cause harmful interference to radio communications. However, there is no guarantee that interference will not occur in a particular installation. If this equipment does cause harmful interference to radio or television reception, which can be determined by turning the equipment off and on, the user is encouraged to try to correct the interference by one or more of the following measures:

- Reorient or relocate the receiving antenna.
- Increase the separation between the equipment and receiver.
- Connect the equipment into an outlet on a circuit different from that to which the receiver is connected.
- Consult the dealer or an experienced radio/TV technician for help.

CAUTION

CHANGES OR MODIFICATIONS NOT APPROVED BY JVC COULD VOID USER'S AUTHORITY TO OPERATE THE EQUIPMENT.

THIS DEVICE COMPLIES WITH PART 15 OF THE FCC RULES. OPERATION IS SUBJECT TO THE FOLLOWING TWO CONDITIONS: (1) THIS DEVICE MAY NOT CAUSE HARMFUL INTERFERENCE, AND (2) THIS DEVICE MUST ACCEPT ANY INTERFERENCE RECEIVED, INCLUDING INTERFERENCE THAT MAY CAUSE UNDESIRED OPERATION.

ATTENTION

RISQUE D'ELECTROCUTION
NE PAS OUVRIR

ATTENTION: POUR EVITER TOUT RISQUE D'ELECTROCUTION
NE PAS OUVRIR LE BOITIER.
AUCUNE PIECE INTERIEURE N'EST
A REGLER PAR L'UTILISATEUR.
SE REFERER A UN AGENT QUALIFIE EN CAS DE PROBLEME.



Le symbole de l'éclair à l'intérieur d'un triangle équilatéral est destiné à alerter l'utilisateur sur la présence d'une "tension dangereuse" non isolée dans le boîtier du produit. Cette tension est suffisante pour provoquer l'électrocution de personnes.



Le point d'exclamation à l'intérieur d'un triangle équilatéral est destiné à alerter l'utilisateur sur la présence d'opérations d'entretien importantes au sujet desquelles des renseignements se trouvent dans le manuel d'instructions.

*Ces symboles ne sont utilisés qu'aux Etats-Unis.

AVERTISSEMENT:
POUR EVITER LES RISQUES D'INCENDIE OU D'ELECTROCUTION, NE PAS EXPOSER L'APPAREIL A L'HUMIDITE OU A LA PLUIE.

Ce magnétoscope ne doit être utilisé que sur du courant alternatif en 120 V.

ATTENTION:
Afin d'éviter tout risque d'incendie ou d'électrocution, ne pas utiliser d'autres sources d'alimentation électrique.

REMARQUE:

La plaque d'identification (numéro de série) se trouve sur le panneau arrière de l'appareil.

WARNING:

The battery used in the BR-DV600U must be replaced by a JVC authorized service dealer only.

This digital apparatus does not exceed the Class B limits for radio noise emissions from digital apparatus as set out in the interference-causing equipment standard entitled "Digital Apparatus", ICES-003 of the Department of Communications.

Cet appareil numérique respecte les limites de bruits radioélectriques applicables aux appareils numériques de Classe B prescrites dans la norme sur le matériel brouilleur: "Appareils Numériques", NMB-003 édictée par le ministre des Communications.

U I E SAFETY PRECAUTIONS

**Warning Notice
FOR YOUR SAFETY (Australia)**

1. Insert this plug only into effectively earthed three-pin power outlet.
2. If any doubt exists regarding the earthing, consult a qualified electrician.
3. Extension cord, if used, must be three-core correctly wired.

**IMPORTANT (In the United Kingdom)
Mains Supply (AC 230 V ~)
WARNING – THIS APPARATUS
MUST BE EARTHED**

The wires in this mains lead are coloured in accordance with the following code:

GREEN-and-YELLOW:	EARTH
BLUE:	NEUTRAL
BROWN:	LIVE

As the colours of the wires in the mains lead of this apparatus may not correspond with the coloured markings identifying the terminals in your plug, proceed as follows.

The wire which is coloured GREEN-AND-YELLOW must be connected to the terminal in the plug which is marked with the letter E or by the safety earth symbol \perp or coloured GREEN or GREEN-AND-YELLOW. The wire which is coloured BLUE must be connected to the terminal which is marked with the letter N or which is coloured BLACK. The wire which is coloured BROWN must be connected to the terminal which is marked with the letter L or coloured RED.

**POWER SYSTEM
Connection to the mains supply**
This unit operates on voltage of 220 to 240 V AC, 50/60 Hz.

WARNING:
TO REDUCE THE RISK OF FIRE OR ELECTRIC SHOCK, DO NOT EXPOSE THIS APPLIANCE TO RAIN OR MOISTURE.

CAUTION
To prevent electric shock, do not open the cabinet. No user serviceable parts inside. Refer servicing to qualified service personnel.

Note:
The rating plate and the safety caution are on the bottom of the unit.

The OPERATE button does not completely shut off mains power from the unit, but switches operating current on and off.

WARNING
It should be noted that it may be unlawful to re-record pre-recorded tapes, records, or discs without the consent of the owner of copyright in the sound or video recording, broadcast, or cable programme and in any literary, dramatic, musical or artistic work embodied therein.

CONTENTS

1 INTRODUCTION	
1-1 Major Features	5
1-2 Maintenance	5
1-3 Precautions	6
2 CONTROLS, CONNECTORS AND DISPLAYS	
2-1 Front Panel	7
2-2 Rear Panel	8
2-3 On-Screen Display	9
2-4 LCD Display	10
3 CONNECTIONS	
3-1 Video system connections	11
3-2 Audio system connections	12
3-3 Other connections	13
3-4 Editing system examples	14
4 MENU SWITCHES	
4-1 Menu switch organization	17
4-2 Menu switch details	18
5 PREPARATION	
Turn the power ON/OFF	21
Loading/unloading a cassette	21
Audio monitor selection	21
Built-in clock setting	22
6 RECORDING	
Recording preparation	23
Recording	23
Audio dubbing	24
Reference	24

7 PLAYBACK	
Playback preparation	25
Playback	25
Repeat play	25
8 EXTERNAL TIMER-START FUNCTION	
Playback	26
Recording	26
9 TIME CODE	
Display	27
Preset	27
Recording	29
Playback	29
Reference	29
10 SUPER SCENE FINDER FUNCTION	30
11 RS-232C INTERFACE	
11-1 Command tables	31
11-2 RS-232C specifications	32
11-3 RS-232C commands	33
12 TROUBLESHOOTING	
12-1 Warning indicators	40
12-2 Other problems	42
13 APPENDIX	
13-1 Optional equipment	42
14 SPECIFICATIONS	43

This unit is designed for use as a recorder/player. Insert editing is not possible.

This video cassette recorder uses the MiniDV format. Use only video cassettes bearing the MiniDV mark.

Please note that it may be unlawful to use any material recorded from TV broadcast programs or pre-recorded programs without the consent of the owner of copyright, except in cases where this material is recorded exclusively for personal use.

JVC is not liable for compensation for loss or damage to recordings in the event this unit fails to record or play back correctly due to a malfunction of the unit itself or as a result of the use of a defective video cassette.

This unit is designed for professional use.

For servicing
See the service manual page 2-5 "2.4 MAINTENANCE AND INSPECTION OF MAJOR PARTS".

1 INTRODUCTION

1-1 Major Features

- MiniDV format
- High-quality picture and sound thanks to digital technology
- DV in/out (IEEE 1394) connector enabling signals to be transferred to or from any device equipped with IEEE 1394 input/output
- Composite, Y/C and component inputs/outputs
- Sync lock function for audio and video signals
- There is no lip link shift even during extended recording
- JVC bus and RS-422 serial remote interfaces
- RS-232C interface (optionally available)
- 2-way power supply system (AC 120 V, DC 12 V) (U MODEL) (AC 220 – 240 V, DC 12 V) (E MODEL)
- Audio dubbing function (32 kHz sampling rate)
- Compact, lightweight design
- SMPTE time code recording and playback (U MODEL)
- EBU time code recording and playback (E MODEL)
- Sampling rate converter for 32 kHz, 12-bit or 48 kHz, 16-bit digital audio
- External timer-start function
- External sync signal input connectors

1-2 Maintenance

The video cassette recorder/player incorporates precision components. Continued use of the VCR without maintenance may lead to malfunctions. Regular maintenance is necessary to prevent malfunctions and maintain the performance level required for professional use.

- Maintenance: Just as regular oil changes, brake checks, and tune-ups are essential to keep your car running well over a long period, your VCR must be maintained regularly to ensure optimum long-term performance.

The information below will help you determine a maintenance schedule that will ensure optimum performance over a long period of time.

Hour meter indication

The hour meter can be displayed by selecting "HM: HOUR METER" on the menu switch setting screen. For details, refer to "Menu Switches" on page 17.

Details for maintenance

Depending on the operation time, clean, inspect or replace the following mechanism components.

Operating time	500H	1000H	1500H	2000H
Drum assembly(including the heads)	○	○	○	●
Head cleaner	☆	●	☆	●
Tape guide roller	○	☆	☆	●
Rotary encoder	—	☆	—	●
Belt and gear	☆	●	☆	●
Driving system parts	○	○	☆	●

- : Inspection
- : Cleaning inspection, adjustment
- ☆ : Cleaning inspection, replacement if required
- : Replacement

This table should be used for reference only. Actual maintenance requirements will vary according to how the unit is used.

Maintenance consultation

Consult your local JVC dealer for more information about maintenance scheduling and costs.

Head cleaning

Recording and playback with clogged heads may result in block noise or sound interruption. In this case, clean the heads.

Use an exclusive head cleaning tape to clean the tape running system. For cleaning procedures and handling precautions, refer to the instructions provided with the cleaning tape.

After cleaning the heads, check that recording and playback function properly before using the unit for any important operations.

Cleaning

Use a soft cloth to clean the cabinet. Do not use benzene or thinner as these may melt or cloud the cabinet surface. To remove excessive dirt, clean the unit with a mild detergent diluted with water, then wipe it with a dry cloth.

1 INTRODUCTION

1-3 Precautions

Installation and storage

- Avoid using the unit in places subject to the following conditions:
 - Extreme heat or cold
 - Strong magnetic field
 - High humidity
 - Dust and soil
 - Vibrations
 - Condensation

Condensation

- Do not use this unit immediately after moving it from a cold place to a warm place or after switching on a heater in a cold room. This will cause water vapor to condense on the video head drum and tape guides and may damage the tape and the VCR.
- When condensation occurs, the DEW indication appears on the tape counter display and the warning indication on the on-screen display. Leave the VCR in this state with the power on and wait until the warning message turns off.



Handling

- Do not block the ventilation openings.
- Do not place anything heavy on the unit.
- Do not put any foreign materials into the cassette loading slot.
- Operate the unit in a horizontal (flat) position only.
- Avoid violent shocks to the unit.

Transportation

- Remove the cassette tape from the unit prior to transportation.

Energy saving

- When not using the unit, turn the power off to avoid unnecessary power consumption.

Cassette tape

- **Type**
Only cassettes bearing the MiniDV mark can be used with this VCR.
- **Handling**
 - Cassette tapes cannot be loaded upside-down.
 - Rewind the tape to the beginning before storage.
 - The number of times a tape can be reused is limited. If the tape is reused more than this, increased noise (such as dropouts) may result. Do not use dirty or damaged tapes. Doing so not only results in poorer performance, but may also shorten the service life of the rotary heads.
 - It is possible that some distortion may occur at the beginning and end of tapes. This can vary depending on the tape. However, for best results, do not use these sections of the tape for any important recordings.

Erasur prevention

MiniDV cassettes are provided with a safety slide on the side to prevent accidental erasure. Set it as required.

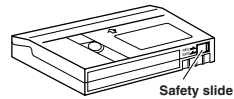

- Move the slide to SAVE to prevent erasure.
- Move the slide to REC to allow recording.

Power supply

- This unit is provided with both AC and DC power supplies. For editing over an extended period, it is recommended that you use a stable AC power supply or DC power supply from an AC adapter. Using battery power is recommended only as a supplementary power source or for field use.
- The AC and DC power supplies are switched automatically. When the AC power supply is switched to the DC power supply, the power turns off. When both power supplies are connected, the AC power supply has priority. Be sure to confirm which power supply is in use when plugging or unplugging the power supply.

2 CONTROLS, CONNECTORS AND DISPLAYS

2-1 Front Panel

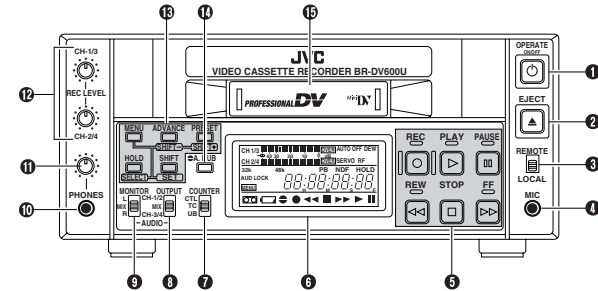

- ① **[OPERATE] switch**
Press this switch to turn this unit ON. Press it again to turn this unit OFF. When the power is OFF, the "oPE-oFF" indication is shown.
- ② **[EJECT] button**
Press to eject the cassette.
- ③ **[REMOTE/LOCAL] switch**
Use to switch between REMOTE and LOCAL.
- ④ **[MIC] jack**
Connect a microphone (3.5 mm dia., -67 dBs, 3 kΩ).
- ⑤ **Operation buttons**
Use to control tape running.
REC: Recording
PLAY: Playback
PAUSE: Temporary stop
REW: Rewinding
STOP: Stop
FF: Fast-forwarding
- ⑥ **LCD Display**
Use to show various data including the tape counter and audio level meter. For details, refer to "LCD display" on page 10.
- ⑦ **[COUNTER] switch**
Use to switch the type of data displayed on the tape counter. When the No. 516 <DISPLAY SELECT> menu switch is set to "CLOCK", clock is shown for TC and date is shown for UB.
- ⑧ **[AUDIO OUTPUT] switch**
Use to select the audio channel to output from the rear panel's [AUDIO OUT] connectors and the headphones.
- ⑨ **[AUDIO MONITOR] switch**
Use to select the audio channel to output from the rear panel's [AUDIO MONITOR OUT] connectors.
- ⑩ **[PHONES] jack**
Connect a set of headphones (3.5 mm dia. mini-jack).
- ⑪ **PHONES control**
Use to adjust the volume level of the headphones connected to the PHONES jack.
- ⑫ **[REC LEVEL] control**
Use to adjust the audio recording level.
CH-1/3: CH1 can be adjusted in normal recording. CH3 recording level can be adjusted in audio dubbing.
CH-2/4: CH2 can be adjusted in normal recording. CH4 recording level can be adjusted in audio dubbing.
Audio dubbing is possible when the No. 245 <SAMPLING RATE> menu switch is set to "32K".
- ⑬ **Setting buttons**
Use to set the menu switch, time code and user bits.
Menu switch setting
MENU: Press to set the menu switch setting mode.
SHIFT +/-: Use to select the menu switch.
SET: Use to enter the set value.
SELECT: Use to change the value.
Time code and user bits setting
HOLD: Press to set the time code, user bits or time date setting mode.
SHIFT: Use to select the digit whose value is to be changed.
ADVANCE: Use to change the value.
While pressing the [SHIFT] button, press this button to reset the set data to "0".
PRESET: Use to enter the changed value and end setting. Use as a counter reset button when the [COUNTER] switch is set to "CTL".
- ⑭ **[AUDIO DUB] button**
Use to perform audio dubbing when the No. 245 <SAMPLING RATE> menu switch is set to "32K".
- ⑮ **Cassette loading slot**
Load and unload a cassette.

Keep in mind that a small amount of current continues to flow into the VCR even when the power is turned off. When not using this unit, disconnect the power cable from the AC outlet. Remove the battery when not in use to avoid excessive discharge.

2 CONTROLS, CONNECTORS AND DISPLAYS

2-2 Rear Panel

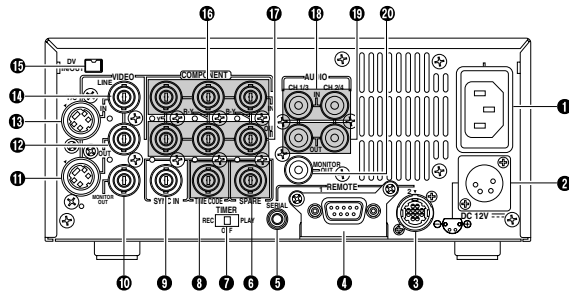

1 AC socket

Connect the provided power cable to supply AC 120 V (U MODEL), AC 220 – 240 V (E MODEL). This unit can be activated automatically when power is supplied according to the setting of 7 [TIMER] switch. ☞ See "EXTERNAL TIMER-START FUNCTION" on page 26.

2 DC socket

Connect DC 12 V (XLR 4-pin). This unit can be activated automatically when power is supplied according to the setting of 7 [TIMER] switch. ☞ See "EXTERNAL TIMER-START FUNCTION" on page 26.

3 [REMOTE] connector (JVC bus)

This unit can be controlled by the RM-G800 via this connector.

4 [REMOTE] connector (RS-422 Serial Connector)

This unit can be controlled by an RS-422 controller. This can be changed to an RS-232C interface if required. For details, contact your local JVC service center.

5 [REMOTE] connector (SERIAL)

Connect a wired remote control such as the RM-G30 to control this unit.

6 [SPARE] connector

This connector is empty and has no function.

7 [TIMER] switch

Use to select the timer operation.
REC : Timer recording
OFF : Timer function OFF
PLAY : Timer playback
☞ See "EXTERNAL TIMER-START FUNCTION" on page 26.

8 [TIME CODE OUT] connector

Use to output time code signals.

9 [SYNC IN] connector

Input reference sync signals.
☞ See "Reference sync signal" on page 11.

10 [VIDEO MONITOR OUT] connector

Connect a video monitor to check the output video or on-screen display from this unit.

11 [Y/C OUT] connector

Outputs Y/C signals.

12 [LINE OUT] connector

Outputs composite signals.

13 [Y/C IN] connector

Receives Y/C signals.

14 [LINE IN] connector

Receives composite signals.

15 [DV IN/OUT] connector

Outputs or receives IEEE 1394 standard digital signals. In addition to digital video and audio signals, control signals can be input or output to/from a personal computer provided with the DV connector (i.LINK), etc.

16 [COMPONENT IN] connectors

Receive component signals. The signal level is for Betacam specifications.

17 [COMPONENT OUT] connectors

Output component signals. The signal level is for Betacam specifications.

18 [AUDIO IN] connectors

Receives audio signals (analog).

19 [AUDIO OUT] connectors

Outputs audio signals (analog). The output audio channel can be selected with the 9 [AUDIO OUTPUT] switch on the front panel.
☞ See "Audio system connections" on page 12.

20 [AUDIO MONITOR OUT] connector

Connect to the audio input of a TV monitor or audio system. The audio channel to be monitored can be selected with the 9 [AUDIO MONITOR OUT] switch.

2 CONTROLS, CONNECTORS AND DISPLAYS

2-3 On-Screen Display

The on-screen display can be viewed on a monitor connected to the rear panel's [VIDEO MONITOR OUT] connector when the No. 500 <ON SCREEN> menu switch is set to "ON". Pressing the [MENU] button will bring up the menu switch display regardless of this setting.

Five types of indication are available.

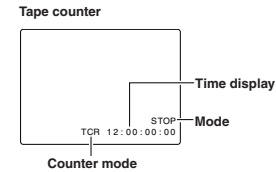

Counter mode indication	Time display contents
CTL	CTL counter data
TCR	Time code reader data
TCG	Time code generator data
UBR	User bits reader data
UBG	User bits generator data
TIME	Time
DATE	Date

Menu switch

000 : SERVO/SYSTEM
100 : VIDEO
200 : AUDIO
300 : SYSTEM
400 : TIME CODE
500 : ONSCREEN
HM : HOUR METER

Hour meter

(HOUR METER)
DH : DRUM HOUR METER 000000H

Tape remaining time

Hour
Minute
01:00
TCR 12:00:00:00

Warning code

WARNING 0201
CONDENSATION ON DRUM
(In case of condensation)

1. Tape counter

The type of data shown on the tape counter display is set with the [COUNTER] switch and menu switch.
Related settings
[COUNTER] switch (front panel)
No. 504 <INFORMATION SELECT>
No. 514 <TIME DISPLAY SELECT>

Mode: Shown when the No. 504 <INFORMATION SELECT> menu switch is set to "MODE + TIME". In this case, the unit's operation status can be checked on the monitor screen.

Time display: The indications shown in the table on the left are available with the counter mode indication.

2. Menu switch

This indication is used to set the menu switch. Shown when the [MENU] button is pressed. Press it once again to restore the previous display.
☞ See "MENU SWITCHES" on page 17.

3. Hour meter

Shows the rotating head usage time. Select "HM: HOUR METER" on the menu switch's group select screen.

4. Tape remaining time

Shows the tape remaining time. Shown when the No. 505 <REMAIN ENABLE> menu switch is set to "ON".

5. Warning message

Automatically shown when an abnormality occurs.
☞ See "Warning indicators" on page 40.

2 CONTROLS, CONNECTORS AND DISPLAYS

2-4 LCD Display

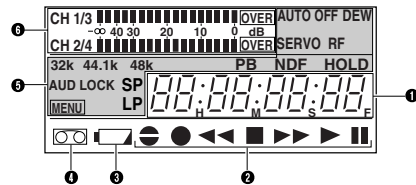

1 Counter display section

Three types of indications can be displayed in the counter display section.

(1) Tape counter

Normally, the indication selected with the [COUNTER] switch is shown. When the No. 516 <DISPLAY SELECT> menu switch is set to "CLOCK", the time and date are shown.

☞ See "Built-in clock setting" on page 22.

(2) Menu switch

In the menu switch setting mode, menu switch items are shown one at a time.

Menu switch No.	Setting
108	00
109	00

(3) Warning code

When this unit malfunctions, the nature of the problem is indicated by an error code.

☞ See "Warning indicators" on page 40.

- In the Operate Off mode, "oPE-oFF" is shown.

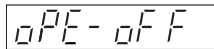

2 Tape running indication

Shows the tape running conditions.

- Audio dubbing mode
- Recording mode
- ◀ Rewind mode
- Stop mode
- ▶ Fast-forward mode
- ▶ Play mode
- Pause mode
- ◀ Reverse search mode
- ▶▶ Fast-forward search mode

3 Battery indicator

When this unit is powered by a battery and the battery voltage level drops below the specified value, this indicator blinks ("off" in normal operation), to show that battery voltage is insufficient. This indicator will also blink when the Operate Off mode is engaged (since voltage output from the battery drops in this mode).

4 Cassette mark

This mark lights to show that a cassette is loaded. This mark is shown even in the Operate Off mode.

5 Indicators

- AUTO OFF:** Lights when a problem occurs in this unit.
- DEW:** Lights when a condensation occurs.
- RF:** Lights when the heads are clogged and the signal level drops.
- SERVO:** Lights when the unit's servo system has stabilized.
- AUD LOCK:** Lights when the video and audio sampling clocks (at 48 kHz) are synchronized in the Play mode. Lights in the Recording mode and EE mode. Does not light when the sampling rate is 32 kHz or 44.1 kHz.
- MENU:** Lights in the menu switch setting mode.
- 32K/44.1K/48K:** Shows the frequency of the digital audio signal sampling rate. In the Record and EE modes, the frequency set with No. 245 <SAMPLING RATE> menu switch is shown. In the Play mode, the playback audio signal mode is shown. The 44.1K indication is shown only in the Play mode.
- PB:** Lights when playback signals are output.
- NDF:** Lights when the non-drop mode is set for time code. (U MODEL)
- DF:** Lights when the drop mode is set for time code. (U MODEL)
- HOLD:** Lights in the time code or user bits setting mode and in the date and time setting mode.
- SP/LP:** Shows the recording or playback speed. Please note that LP mode recording and playback is not possible with this unit. If you try to play back a tape recorded in the LP mode, the "LP inh" indication is shown and the VCR enters the Stop mode.

6 Audio channel indication

Shows the audio channel of the signal output from the rear panel's [AUDIO OUT] connectors. Indication and output signals can be switched with the front panel's [AUDIO OUTPUT] switch only when 32 kHz sampling rate signals are played back. In other modes, the indication and output signals are fixed as shown in the table below.

Sampling rate Mode	32K			48K		44.1K
	PB	A.DUB	EE/REC	PB	EE/REC	PB
CH 1 CH 2	○	○	Fixed	○	Fixed	Fixed
CH 3 CH 4	○	Fixed	-	-	-	-
CH 1/3 CH 2/4	○	-	-	-	-	-

PB: Play mode
A.DUB: Audio Dubbing mode
EE: EE mode
REC: Record mode

3 CONNECTIONS

3-1 Video system connections

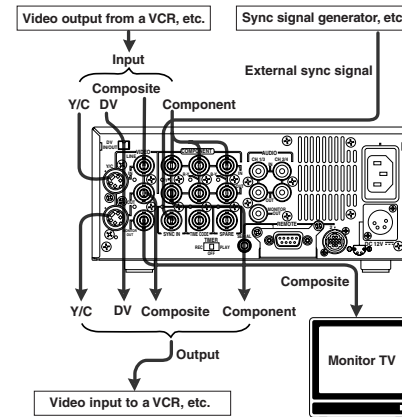

Connecting a monitor

The on-screen display can be viewed on a monitor connected to the [VIDEO MONITOR OUT] connector.

Connecting video equipment

Connect the video device to the appropriate connector (4 types are available).

Outputs

- **Analog outputs**
Composite signal : [LINE OUT] connector (BNC)
Component signal (Y/B-Y/R-Y) : [COMPONENT OUT] connectors (BNC x 3)
Y/C signal : [Y/C OUT] connector (4-pin)
- **Digital output**
Digital video signal (conforming to IEEE 1394)
[DV IN/OUT] connector

Inputs

- Select input video signals with the No. 108 <VIDEO INPUT SELECT> menu switch.
- **Analog inputs**
Composite signal : [LINE IN] connector (BNC)
Component signal (Y/B-Y/R-Y) : [COMPONENT IN] connector (BNC x 3)
Y/C signal : [Y/C IN] connector (4-pin)
- **Digital input**
Digital video signal (conforming to IEEE 1394) : [DV IN/OUT] connector

Notes:

- When search pictures or low-quality video signals are input, temporary distortion of picture or sound may occur. Clean up the signals with a TBC or other processing device before inputting.

Reference sync signal

This unit automatically selects the sync signal as shown in the table below, depending on the presence of external sync input (SYNC IN) and video input (VIDEO IN), the No. 003 <SYNC SELECT> menu switch setting and operation mode. When IEEE 1394 input is selected, "INT" is selected regardless of the setting. When the No. 108 <VIDEO INPUT SELECT> menu switch is set to "COMPONENT", the operation is the same as that performed with the No. 003 <SYNC SELECT> menu switch set to "AUTO" regardless of the setting.

SYNC IN	No	Yes	No	Yes
VIDEO IN	No	No	Yes	Yes
EXTERNAL	Playback	INT	EXT	EXT
	Recording	INT	INT	VIDEO
AUTO	Playback	INT	EXT	VIDEO
	Recording	INT	INT	VIDEO

INT: Internal sync EXT: External sync VIDEO: Video sync

Notes:

- The phase of the output signal cannot be adjusted for external sync signals. The sub carrier cannot be locked.
- Plugging and unplugging the external sync or video signal connector during operation causes distortion in the picture and sound for about 10 seconds.
- When signals input from the composite connector are output from the component connector, color may disappear in some parts of the left section of the monitor screen. This is not a malfunction.
- The set up is not applied to signals input to the [DV IN/OUT] connector and output in EE mode (component, Y/C, composite). Input signals are recorded as is.
- Use a video signal of less than 1 V(p-p) such as a black burst signal for external sync signal.
- When video signals are input to the DV IN/OUT connector, distortion may occur in the lower section of the picture in the EE mode. However, recording is performed normally.
- When the No. 003 <SYNC SELECT> menu switch is set to "EXTERNAL" and no signal is input to the [SYNC IN] connector, noise may appear in the playback picture. This is not a malfunction.

3 CONNECTIONS

3-2 Audio system connections

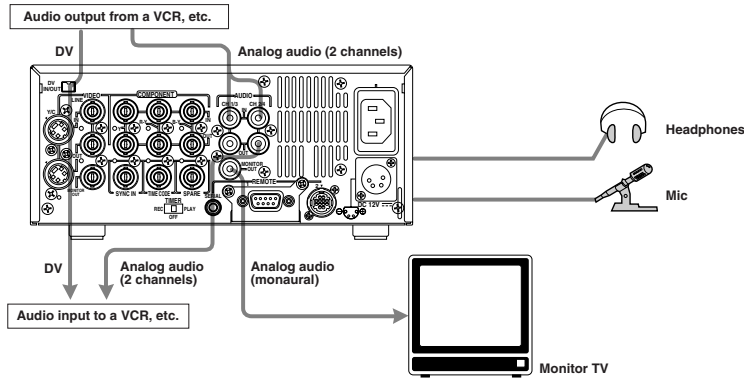

Connection with a monitor TV

The audio output from the [AUDIO MONITOR OUT] connector is monaural.

Use the front panel [AUDIO MONITOR] switch to select the audio channels you want to monitor. The selected audio channel is shown in the table below. Adjust the audio volume level on the monitor.

Headphones jack

Audio can be monitored in stereo using the headphones. Use the front panel [AUDIO OUTPUT] switch to select the audio channels you want to monitor. The selected audio channel is shown in the table below. Adjust the audio volume level with the front panel [PHONES] control.

Inputs

■ Analog inputs

Audio connectors (CH1/3, CH2/4) Analog input connectors are only provided for 2 channels. It is not possible to record 4 channels simultaneously. Audio input from each connector is normally recorded on the CH1 and CH2 channels. Recording on the CH3 and CH4 can be performed in the Audio Dubbing mode with the No. 245 <SAMPLING RATE> menu switch set to "32K". For audio dubbing, refer to "Audio dubbing" on page 24.

■ Digital inputs

Digital signals conforming to IEEE 1394 can be input to the [DV IN/OUT] connector. In this case, the audio recording level cannot be adjusted. When audio signals are input to the [DV IN/OUT] connector, some noise will occur at the point where recording ends. To reduce this noise during playback, set the No. 214 <V. FADE> menu switch to "ON".

■ Mic input jack

Connect a monaural microphone. The same audio is recorded on both channels.

Outputs

■ Analog outputs

Audio connectors (CH1/3, CH2/4) Analog output connectors are provided for 2 channels. For MiniDV format, use the front panel [AUDIO OUTPUT] switch to select for 4-channel audio. The selected audio channel is shown in the table below.

■ Digital outputs

Digital signals conforming to IEEE 1394 are output from the [DV IN/OUT] connector.

Relationship between [AUDIO OUTPUT] / [AUDIO MONITOR] switch and audio output channel

(During playback with 32 kHz sampling, audio dubbing, and DV input with the 32 kHz sampling in the EE mode) Regardless of setting of this switch, CH1/2 is selected for ordinary recording, record pause and analog audio input in the EE mode. CH3/4 is selected for audio dubbing in the Pause mode.

MONITOR	AUDIO switch	MONITOR OUT	Connector	
			CH1/3	CH2/4
L	CH1/2	CH1	CH1	CH2
	MIX	CH1/3	CH1/3	CH2/4
	CH3/4	CH3	CH3	CH4
MIX	CH1/2	CH1/2	CH1	CH2
	MIX	CH1/2/3/4	CH1/3	CH2/4
	CH3/4	CH3/4	CH3	CH4
R	CH1/2	CH2	CH1	CH2
	MIX	CH2/4	CH1/3	CH2/4
	CH3/4	CH4	CH3	CH4

3 CONNECTIONS

3-3 Other connections

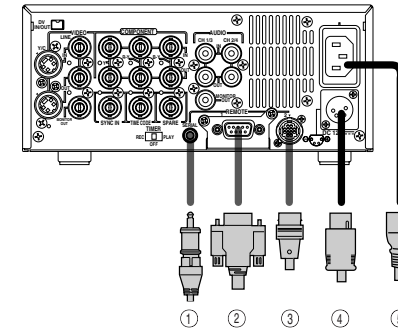

Remote connector

Connect a remote controller to the appropriate connector (three types are available).

Type of connector	Connectable remote controller
① [SERIAL] connector	RM-G30
② [REMOTE1] connector	RM-G820
③ [REMOTE2] connector	RM-G800

Note:

- Before connecting the RM-G800, be sure to turn the VCR OFF. Do not connect or disconnect the remote cable with the VCR ON.

Power sockets

2 types of power supply are available (AC, DC).

DC power supply socket

① Connect DC 12 V.

AC power supply socket

③ Connect AC 120 V (U MODEL), AC 220 – 240 V (E MODEL).

■ Selection of battery type

Set the menu switch according to the type of battery that will be used.

* If the setting does not correspond to the battery type, the battery remaining time and battery alarm will not be correctly displayed.

Note:

- Do not use this unit continuously when the battery indicator is displayed. The unit may not operate properly. Remove the battery to avoid over-discharge.

☞ See "396 BATTERY SELECT" on page 19.

• Used battery

The following batteries can be used with this unit.

- Flat shape type
 - Anton Bauer Inc. : Trimpack 13 and 14 series
 - Pro Pac 13 and 14 series
- IDX Corporation : NP-L46

3 CONNECTIONS

3-4 Editing system examples

The BR-DV600U can be used as a feeder for different video formats.

■ Simplified digital cut editing system

Using an editing remote controller with JVC bus specifications such as the RM-G800, digital cut editing is possible with another MiniDV VCR. When the BR-DV600U is used as a recorder, the following editing operations cannot be performed.

- Preview
- Insert editing
- EE function (auto EE function)

As the phase sync function does not work, the editing accuracy is ± 5 frames.

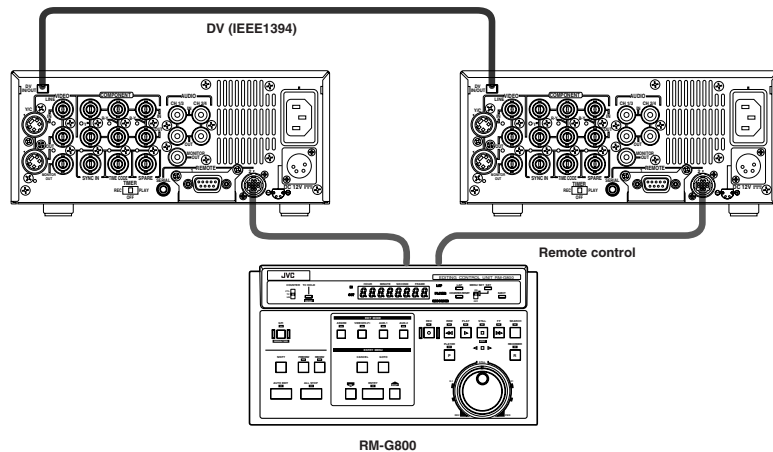

Notes:

- When used in an editing system with the RM-G800, the BR-DV600's preroll operation is comparatively slow. This is normal and is not a malfunction.
- When editing, the input signal (picture from the playback VCR) can be monitored. The playback picture of the recorder VCR just before the edit-in point cannot be checked.
- This unit cannot be used for CTL editing. Use for the time code editing.
- During remote control operation, be sure to turn the jog dial slowly. Otherwise, the VCR may not be able to keep up with the operation.
- When this unit is operated with the remote control unit, audio cannot be checked if it is played back at a speed of less than 1x.
- If editing is started in the Pause mode (still) at the preroll point, editing accuracy may be degraded.
- Use the RM-G800 with the out-point return function OFF. Otherwise, it takes longer to stop editing.
- Use the RM-G800 with the Auto EE mode OFF. Otherwise, the IEEE 1394 "EE inh" error indication is shown.

3 CONNECTIONS

3-4 Editing system examples

■ Mixed S-VHS/VHS system

This is an editing system which uses the BR-DV600U as a feeder/player with an RS-422A serial remote controller such as the RM-G820. In this case, **the BR-DV600U cannot be used as a recorder VCR.**

The S-VHS/VHS VCR can be replaced with a D-9/Betacam VCR.

The following editing operations are not available.

- Variable search
- Slow-motion editing
- CTL editing

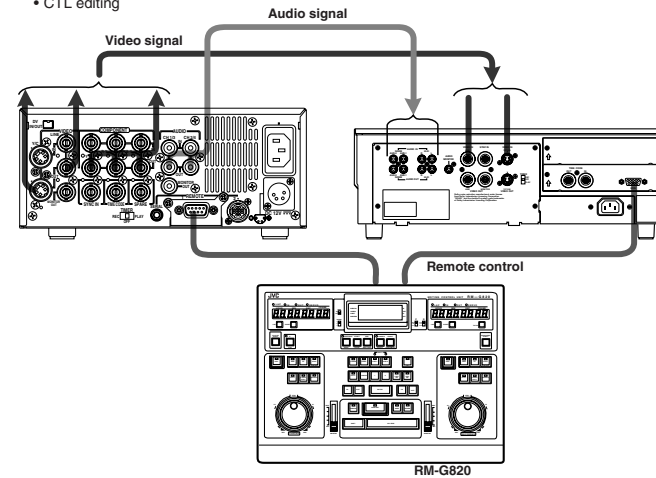

Notes:

- Even during the time code editing, the editing accuracy of 0 frame cannot be obtained. Set the remote control's sync grade to ± 1 frame.
- During remote control operation, be sure to turn the jog dial slowly. Otherwise, the VCR may not be able to keep up with the operation.
- When this unit is operated with the remote control unit, audio cannot be checked if it is played back at a speed of less than 1x.

4 MENU SWITCHES

4-2 Menu switch details

For switch setting procedures, refer to "Menu switch setting procedure".

- Factory setting
- (00): The number in the bracket shows the set value on the counter display.

002 OPERATION LOCK

Details: Switches the operation lock ON/OFF.

Setting:

- OFF (00): The operation lock is OFF: all operations are enabled.
- ON (01): The operation lock is ON: all controls are disabled except for the [MENU] button.

003 SYNC SELECT

Details: Selects the sync signal during play.

Setting:

- EXTERNAL (01): Synchronizes with the signal input to the [SYNC IN] connector.
- AUTO (03): Switches the synchronization automatically depending on whether or not a signal is input to the [SYNC IN] connector. For details, refer to page 11.

050 REMOTE SELECT

Details: Selects the remote controller connected to the [REMOTE] connector on the rear panel. When the optional SA-K46 RS-232C interface board is installed at the [REMOTE 1] connector, some setting indications will change.

Setting:

- IEEE 1394 (01): Allows control of this unit with the controller connected to the [DV IN/OUT] connector.
- RS422A (04): Allows control of this unit with the controller connected to the [REMOTE 1] connector.
- IEEE 1394 + RS422A (05): Allows control of this unit with the controllers connected to the [DV IN/OUT] and [REMOTE 1] connectors.
- JVC BUS (08): Allows control of this unit with the controller connected to the [REMOTE 2] connector.
- JVC BUS + IEEE 1394 (09): Allows control of this unit with the controllers connected to the [REMOTE 2] and [DV IN/OUT] connectors.
- JVC BUS + RS422A (12): Allows control of this unit with the controllers connected to the [REMOTE 2] and [REMOTE 1] connectors.
- JVC BUS + RS422A + 1394 (13): Allows control of this unit with the controllers connected to the [REMOTE 2], [REMOTE 1] and [DV IN/OUT] connectors.

(When the optional SA-K46 RS-232C interface board is installed)

- IEEE 1394 (01): Allows control of this unit with the controller connected to the [DV IN/OUT] connector.
- RS232C (02): Allows control of this unit with the controller connected to the [REMOTE 1] connector.
- IEEE 1394 + RS232C (03): Allows control of this unit with the controllers connected to the [DV IN/OUT] and [REMOTE 1] connectors.
- JVC BUS (08): Allows control of this unit with the controller connected to the [REMOTE 2] connector.
- JVC BUS + IEEE 1394 (09): Allows control of this unit with the controllers connected to the [REMOTE 2] and [DV IN/OUT] connectors.
- JVC BUS + RS232C (10): Allows control of this unit with the controllers connected to the [REMOTE 2] and [REMOTE 1] connectors.
- JVC BUS + RS232C + 1394 (11): Allows control of this unit with the controllers connected to the [REMOTE 2], [REMOTE 1] and [DV IN/OUT] connectors.

108 VIDEO INPUT SELECT

Details: Selects the input video signal.

Setting:

- LINE (00): Selects video signals input to the [LINE IN] connector.
- Y/C (01): Selects video signals input to the [Y/C IN] connector.
- COMPONENT (02): Selects video signals input to the [COMPONENT IN] connector.
- IEEE 1394 (03): Selects video and audio signals input to the [DV IN/OUT] connector. In this case, analog audio signals are not input.

125 SETUP (U MODEL)

Details: Sets whether or not the setup is applied to the analog video signals (composite, Y/C, component).

Setting:

- OFF (00): Does not apply the setup.
- ON (01): Applies the setup. Set to this position to play back a tape recorded on the GY-DV500.

Notes:

- This setting affects recording and playback of analog video signals.
- Picture hue and brightness can be affected if dubbing is repeated without applying a setup suitable to video signals.

4 MENU SWITCHES

4-2 Menu switch details

- Factory setting
- (00): The number in the bracket shows the set value on the counter display.

212 AUDIO OUT AT SEARCH

Details: Selects whether or not audio is output to the [AUDIO OUT] and [AUDIO MONITOR OUT] connectors and headphones jack during search at speeds above $\pm 1\times$.

Setting:

- OFF (00): No output.
- ON (01): Audio is output.

214 V. FADE

Details: Switches the V. fade function ON/OFF. V. fade reduces audio noise at the tag recording during playback.

Setting:

- OFF (00): The V. fade function is not activated.
- ON (01): Activates the V. fade function.

245 SAMPLING RATE

Details: Selects the sampling rate frequency when recording audio digitally.

Setting:

- 32K (00): Records signals at a 32 kHz sampling frequency. Set to this position for audio dubbing on CH3 and CH4.
- 48K (01): Records signals at a 48 kHz sampling frequency. Audio dubbing is not possible with this setting.

311 AUTO PLAY

Details: Selects whether or not playback starts automatically after the tape is rewound to the beginning.

Setting:

- SHORT FF (00): The tape stops after short FF. Auto play does not start.
- PLAY (01): Auto play starts. Repeat playback is available when No. 312 <AUTO REW> menu switch is set to "ON".

312 AUTO REW

Details: Selects whether or not the tape is rewound automatically at tape end during recording or playback.

Setting:

- OFF (00): The tape is not rewound automatically.
- ON (01): The tape is rewound automatically. Repeat playback is available when No. 311 <AUTO PLAY> menu switch is set to "PLAY".

353 EDIT ADJUST

Details: When this unit is used with an editing controller and the edit-in point is shifted, this corrects the play start timing. Switch setting differs depending on the configuration of the editing system. For details, refer to "Edit adjust setting" on page 16.

Setting:

- 0F: No compensation.
- 1F: The playback start point is delayed by 1 frame.
- 2F: The playback start point is delayed by 2 frames.
- 3F: The playback start point is delayed by 3 frames to the factory set timing.
- 4F: The playback start point is delayed by 4 frames.
- 5F: The playback start point is delayed by 5 frames.
- 6F: The playback start point is delayed by 6 frames.
- 7F: The playback start point is delayed by 7 frames.

360 AUTO REW AT TIMER

Details: Selects whether or not the tape is automatically rewound when the VCR power is switched ON in the Timer Play or Recording Standby mode.

Setting:

- OFF (00): Playback or recording starts immediately. The tape is not rewound.
- ON (01): Playback or recording starts after the tape is rewound to the beginning.

363 CONTROLLER SELECT

Details: Selects the setting according to the type of remote control unit connected via the RS-422A interface.

Setting:

- TYPE 1 (00): For the RM-G820.
- TYPE 2 (01): For a non-linear editing system.
- TYPE 3 (02): Unused.
- :
- TYPE 8 (07)

396 BATTERY SELECT

Details: When using DC power, set this switch according to the DC power supply and battery type.

Setting:

- 12 V (00): Select this setting to use a DC power supply (AA-G10) or DC 12 V flat shape type battery.
- 13.2 V (01): Select this setting to use Anton Bauer Inc.'s Trimpack 13, ProPac 13.
- 14.4 V (02): Select this setting to use Anton Bauer Inc.'s Trimpack 14, ProPac 14 and IDX Corporation's NP-L46.

4 MENU SWITCHES

4-2 Menu switch details

●: Factory setting
(00): The number in the bracket shows the set value on the counter display.

397 FAN STOP SHUTDOWN

Details: Sets whether or not VCR operation continues if the fan motor stops.

Setting:

- ENABLE (00): The power turns off about 1 minute after the fan motor stops.
- DISABLE (01): The VCR continues operation even after the fan motor stops. When the fan motor stops, press the [OPERATE] button as soon as possible to turn the VCR's power off. If not, a malfunction may occur due to overheating.

414 TCG SELECT

Details: Selects the time code generator mode.

Setting:

- PRESET (00): Engages the Preset mode.
- REGEN (01): Engages the Regen mode.

415 TCG MODE

Details: Selects the time code generator Run mode.

Setting:

- FREE RUN (00): Engages the Free Run mode.
- REC RUN (01): Engages the Rec Run mode.

416 NON DROP/DROP (U MODEL)

Details: Selects the time code generator Drop Frame mode.

Setting:

- DROP (00): Engages the Drop Frame mode.
- NON DROP (01): Engages the Non-Drop Frame mode.

500 ON SCREEN

Details: Selects whether or not the on-screen display is shown on the monitor.

Setting:

- OFF (00): The display is not shown.
- ON (01): The display is shown.

501 CHARACTER H.POSITION

Details: Moves the display position of the tape counter on screen, etc. horizontally.

Setting:

- 0 (00) The display position can be moved in 9 steps from 0 to 8. The factory setting is 8 (08) "0" (the display position at the far right).
- * The tape remaining time indication position cannot be changed.

502 CHARACTER V.POSITION

Details: Moves the display position of the tape counter on screen, etc. vertically.

Setting:

- 0 (00) The display position can be moved in 12 steps from 0 to 11. When the No. 504 <INFORMATION SELECT> menu switch is set to "MODE + TIME", setting to "0" is not possible.
- 1 (01)
- :
- 11(11) * The tape remaining time indication position on screen can be changed up and down with this switch.

504 INFORMATION SELECT

Details: Selects which information is displayed on the on-screen display.

Setting:

- TIME (00): Time data is displayed
- MODE+TIME (01): Time data and tape running mode are displayed.

505 REMAIN ENABLE

Details: Selects whether or not the tape remaining time is shown on the on-screen display.

Setting:

- OFF (00): Remaining time is not shown.
- ON (01): Remaining time is shown.

514 TIME DISPLAY SELECT

Details: Selects the type of time data displayed.

Setting:

- DATE (00): Shows the date.
- CLOCK (01): Shows the time.
- DATE+CLOCK (02): Shows the date and time.
- TC (03): Shows the time code data.

516 DISPLAY SELECT

Details: Selects the type of data displayed on the tape counter in the LCD display.

Setting:

- TC (00): Shows the time code data.
- CLOCK (01): Shows the date and time. You can switch between date and time with the [COUNTER] switch.

5 PREPARATION

Preparing this unit for recording or playback.

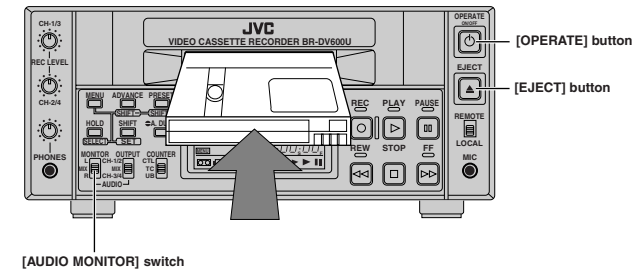

Turn the power ON.

Press the [OPERATE] switch. The counter display lights up.

Turn the power OFF

Press the [OPERATE] switch. "oPF-oFF" is shown in the counter display.

Loading/unloading a cassette

Insert the cassette into the cassette loading slot with the window facing up. Push the cassette in slowly until the loading mechanism starts automatic loading.

→ The VCR enters the Stop mode and the cassette indicator () lights.

Press the [EJECT] button to eject the cassette.
→ The cassette tape is ejected.

Audio monitor selection

Use the [AUDIO MONITOR] switch to select the audio channel to monitor (via the [AUDIO MONITOR OUT] connectors).

5 PREPARATION

Built-in clock setting

Time data is recorded in the sub code area of the tape during recording. In the Play mode, this data is read out and can be shown on the on-screen display or the counter display.

[Reference]

Clock data is retained for about 60 hours after the 6-hour power supply is used up (Operate On mode).

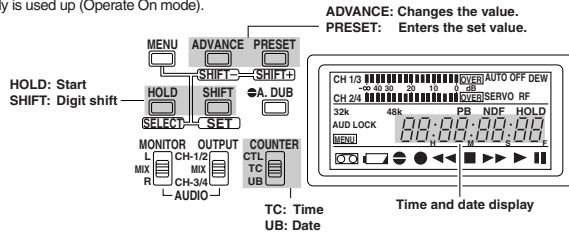

■ Setting procedure

The names of the operation buttons are shown above the buttons.

- Set the tape counter display to the time display.**
Set the No. 516 <DISPLAY SELECT> menu switch to "CLOCK".
See No. 516 <DISPLAY SELECT> on page 20.
- Set the [COUNTER] switch to "TC" or "UB".**
 - To set the time, set to "TC".
The time display is shown in the tape counter.
 - To set the date, set to "UB".
The date display is shown in the tape counter.
- Engage the setting mode.**
Press the [HOLD] button.
 - Clock setting
→ The hour digit starts to blink.
 - Date setting
→ The month (U MODEL), day (E MODEL) digit starts to blink.
- Change the value.**
Each time the [ADVANCE] button is pressed, the value of the blinking digit increases.
While holding down the [SHIFT] button, press the [ADVANCE] button to reset the value as follows.
 - Clock setting: "00:00:00"
 - Date setting: "01:01:2000"
- Shift the digit.**
Press the [SHIFT] button.
 - Clock setting: Each time the [SHIFT] button is pressed, the blinking cursor moves in the order of hours → minutes → seconds.
 - Date setting: Each time the [SHIFT] button is pressed, the blinking cursor moves in the order of month → day → year (U MODEL), day → month → year (E MODEL). Repeat steps 4 to 5 to change the values for each digit.
- Enter the set data.**
Press the [PRESET] button to enter the set data.

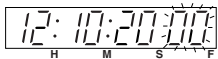
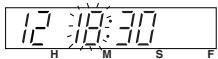
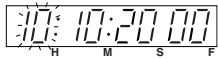
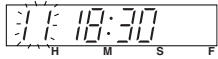

6 RECORDING

[REC LEVEL] control

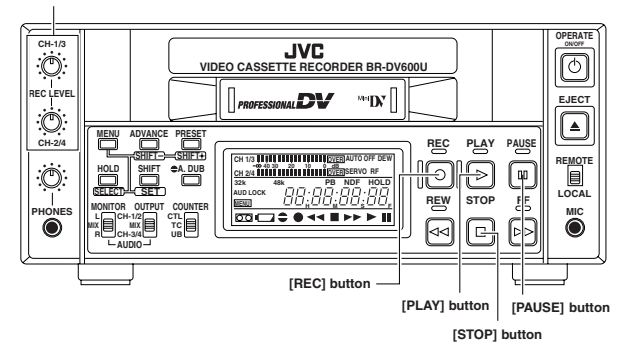

Recording preparation

Loading a cassette

Check that the erasure prevention tab is set to allow recording.
Insert the cassette in the cassette loading slot.

Input video signal selection

Select the input video signal with the No. 108 <VIDEO INPUT SELECT> menu switch.

LINE: Selects the composite video signals input to the [LINE IN] connector.

Y/C: Selects the Y/C signals input to the [Y/C IN] connector.

COMPONENT: Selects the component video signals input to the [COMPONENT IN] connector.

IEEE 1394: Selects the digital video signals and the digital audio signals input to the [DV IN/OUT] connector.

Audio sampling rate setting

Select the audio sampling rate with the No. 245 <SAMPLING RATE> menu switch.
The number of usable audio channels is determined by the sampling frequency selected with the No. 245 <SAMPLING RATE> menu switch.

- 32 kHz: 4 channels
- 48 kHz: 2 channels

Signals are recorded on CH1 and CH2. Audio dubbing is not possible.

Adjust the audio recording level with the [REC LEVEL] control.

Recording

- Press the [PLAY] button while holding down the [REC] button.
→ Recording starts.
- Press the [PAUSE] button to temporarily stop recording.
To restart recording, press the [PLAY] button.
To stop recording, press the [STOP] button.

Notes:

- If the unit remains in the Pause mode for more than 5 minutes, the Stop mode is automatically engaged to prevent the tape from being damaged. If tape remaining time is less than 3 minutes or the unit is being used in a low-temperature environment, the Stop mode is engaged within about 3 minutes.
- When a tape recorded on this unit is played back on a consumer MiniDV VCR, the sound level may be low.
- During recording, the upper section of the picture may be distorted or defect. This is not a malfunction.

6 RECORDING

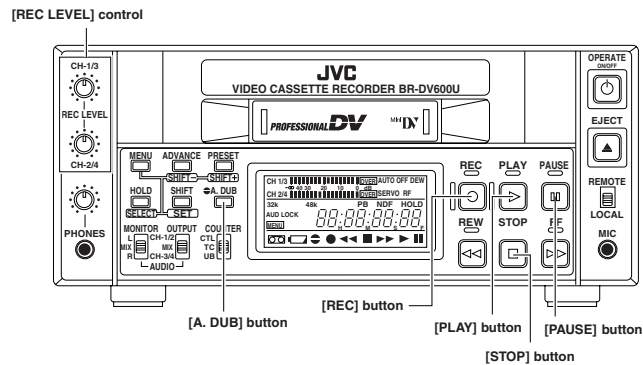

Audio dubbing

Signals can only be recorded on CH3 and CH4.

- 1 Set the No. 245 <SAMPLING RATE> menu switch to "32K".

Set the No. 108 <VIDEO INPUT SELECT> menu switch to any position except "IEEE 1394". (Audio dubbing is not possible with digital audio input.)

- 2 Press the [PLAY] button to play back the tape.
- 3 Press the [PAUSE] button at the position from which you want to start recording audio. While holding the [PAUSE] button, press the [A.DUB] button.

• Audio dubbing

The Audio Dubbing Pause mode cannot be engaged unless the VCR is in the Stop mode. First engage the Stop mode. Then, while holding down the [PAUSE] button, press the [A. DUB] button.

- 4 Adjust the audio recording level with the [REC LEVEL] control.
- 5 Press the [PLAY] button to start audio dubbing. — Audio signals are recorded on CH3 and CH4. To stop audio dubbing temporarily, press the [PAUSE] button.
- 6 To end audio dubbing, press the [STOP] button.

Notes:

- Audio dubbing is not possible on tapes recorded with 48 kHz sampling frequency.
- If audio dubbing is performed repeatedly on a short section of the tape, there may be some noise when this section is played back.
- For audio dubbing, use a tape recorded with this unit. If another tape is used, first dub it to a tape on this unit. When audio is dubbed on a tape recorded on another VCR (including another BR-DV600), sound and picture may be distorted.
- During audio dubbing, noise might be visible on the playback picture. But it is not a trouble of BR-DV600. Audio dubbing itself is proceeded normally.
- It is not possible to use the audio dubbing function to record the CH1/2 playback signal on CH3/4 (sound-on-sound).

Reference

Recording section on the tape

In the MiniDV format, one video frame consists of 10 tracks. Each track includes recording sections for audio, video and sub code (time code, date, time).

As shown in the diagram, the audio recording section provides 2 channels or 4 channels depending on the sampling rate frequency selected. In the Audio Dubbing mode, audio signals are recorded in the CH3 and CH4 section which is created when the 32 kHz sampling frequency is selected.

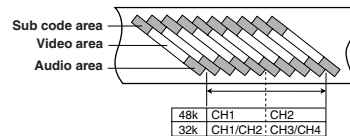

7 PLAYBACK

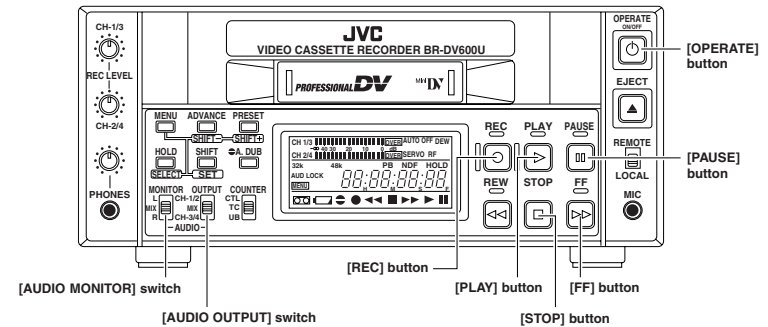

Playback preparation

- 1 Press the [OPERATE] button to turn the power ON.
- 2 Insert the cassette into the cassette loading slot.
- 3 Select the audio output channel.

Select the signals output from the [AUDIO OUT] connectors with the [AUDIO OUTPUT] switch.

☞ See "Audio system connections" on page 12.

Playback

- 1 Press the [PLAY] button. Video and audio signals are output from each output connector. Other data recorded on the tape is read out (time code, user bits, etc.)
- 2 To stop playback, press the [STOP] button.
- 3 To temporarily stop playback, press the [PAUSE] button.
 - For fast-forward playback, press the [FF] button during playback.
 - For fast reverse playback, press the [REW] button during playback.
 - You can select whether or not to play sound during fast-forward playback or fast reverse playback with the No. 212 <AUDIO OUT AT SEARCH> ON/OFF setting.

Repeat play

- 1 Set the No. 311 <AUTO PLAY> and No. 312 <AUTO REW> menu switches to "ON".
 - ☞ See No. <311 AUTO PLAY> and No. 312 <AUTO REW> on page 19.
- 2 Press the [PLAY] button to start playback. At tape end, the tape is rewound automatically and playback starts again. This operation repeats each time the tape ends.
- 3 To stop Repeat Play, press the [STOP] button.

Notes:

- If audio dubbing is performed repeatedly on a short section of the tape, there may be some noise when this section is played back.
- When a tape recorded on a consumer MiniDV VCR is played back on this unit, the sound level may be low.
- When the Pause mode continues for more than 5 minutes, the Stop mode is automatically engaged to protect the tape. If tape remaining time is less than 3 minutes or the unit is being used in a low-temperature environment, the Stop mode is engaged within about 3 minutes. The Stop mode is also engaged automatically if slow playback continues for more than 1 minute with the remote controller or reverse slow playback continues for more than 20 seconds.

8 EXTERNAL TIMER-START FUNCTION

(AUTOMATIC START-UP WITH POWER SUPPLY)

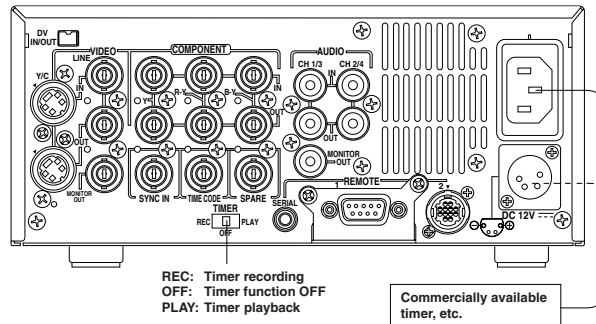

When power (AC 120 V (U MODEL), AC 220 – 240 V (E MODEL) or DC 12 V) is supplied to this unit, it automatically enters the Record or Play mode. Using a commercially available timer, you can configure your VCR to start recording or playback at a specified time.

Playback

- 1 Connect the power cable.**
To turn this unit ON with a commercially available timer, connect the power cable plug to the timer's power output socket.
Set the front panel's [REMOTE/LOCAL] switch to "LOCAL".
- 2 Insert a cassette.**
- 3 Set the rear panel's [TIMER] switch to "PLAY".**
- 4 When power is supplied, playback starts automatically.**
Repeat playback can be set with menu switch setting.
See No. <311 AUTO PLAY> and No. 312 <AUTO REW> on page 19.
With the menu switches set appropriately, the tape can be rewound to the beginning before starting playback.
See No. 360 <AUTO REW AT TIMER> on page 19.
- 5 Stop playback.**
Press the [STOP] button.

Recording

- 1 Connect the power cable.**
To turn this unit ON with a commercially available timer, connect the power cable plug to the timer's power output socket.
Set the front panel's [REMOTE/LOCAL] switch to "LOCAL".
- 2 Select the video input.**
- 3 Adjust the audio recording level.**
- 4 Insert a cassette.**
- 5 Set the rear panel's [TIMER] switch to "REC".**
- 6 When power is supplied, the VCR automatically enters the Record mode.**
Using the menu switches, you can set the VCR to start recording after rewinding the tape to the beginning.
See No. 360 <AUTO REW AT TIMER> on page 19.
- 7 Stop recording.**
Press the [STOP] button.

Note:

- External timer control should only be used to start VCR operation. Do not use an external timer to turn the VCR power off while the tape is running. Doing so could damage this unit or the tape.

9 TIME CODE

The time code is recorded frame by frame together with the materials to be recorded on the tape. With this time code, the position of the materials can be precisely specified, improving the editing accuracy and working efficiency.
(The editing accuracy of 0 frame may not be obtained even though the time code is used, depending on the performance of the VCR and editing controller and influence of editing system.)
With this system, the time code can be recorded and played back.

On-screen display

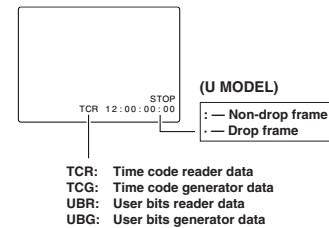

Counter display



HOLD: Start
SHIFT: Moves the cursor to the next digit.

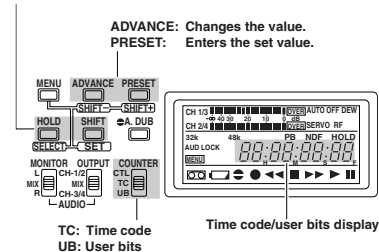

Display

Time code can be shown on the counter display and on the on-screen display during playback and recording.

- 1 To display time code data on the on-screen display, set the No. 514 <TIME DISPLAY SELECT> menu switch to "TC".**
See No. 514 <TIME DISPLAY SELECT> on page 20.
- 2 To display time code data on the counter display, set the No. 516 <DISPLAY SELECT> menu switch to "TC".**
See No. 516 <DISPLAY SELECT> on page 20.
- 3 Set the [COUNTER] switch to "TC" or "UB".**
TC: Shows the time code data display.
UB: Shows the user bits display.
All time code data including time code generator/reader, drop/non-drop frame (U MODEL), CTL interpolation, etc. are shown on the on-screen display

Preset

To give you more control over your material in editing and recording, you can specify a preset time code value while referring to the counter display indications. Determine the required time code value beforehand.

- Set the [COUNTER] switch to "TC" so that the counter display shows the time code.
- Set the [COUNTER] switch to "UB" to show the user bits on the counter display.

Time code presetting is described below. The same procedure is used to preset the user bits, except that user bit values are hexadecimal (0 to F).

9 TIME CODE

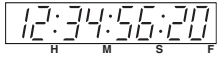

- 1 Set the menu switches. (See page 20.)
 - Set the No. 414 <TCG SELECT> menu switch to "PRESET".
 - Set the No. 415 <TCG MODE> menu switch. Setting is not necessary for user bits.
 - REC RUN: The time code is counted only during recording.
 - FREE RUN: The time code is counted after the preset is complete.

- Set the No. 416 <NON DROP/DROP> menu switch. Setting is not necessary for user bits.
 - NON DROP : Engages the Non-Drop Frame mode.
 - DROP : Engages the Drop Frame mode.

(U MODEL)

- 2 Press the [HOLD] button to engage the time code setting mode.
 - The uppermost digit blinks.
- 3 Press the [ADVANCE] button to change the value.
 - The blinking number increases.
 - Hold down the [SHIFT] button and press the [ADVANCE] button to reset all digits to "0".
- 4 Press the [SHIFT] button to change the digit.
 - The blinking cursor on the digit moves to the right.
- 5 To change the digit, repeat steps 3 to 4.
- 6 Press the [PRESET] button to enter the value.
 - The time code setting mode is released and the normal display is restored.
- 7 To check the preset time code, press the [REC] button in the Stop mode.

9 TIME CODE

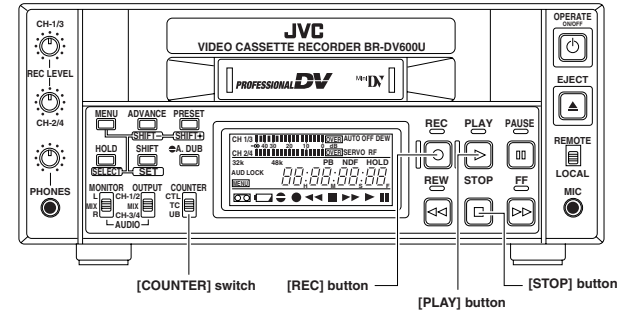

Recording

Time code can be recorded in the following ways.

- Time code recording starts from the preset data.
- Time code recording follows the time code already recorded on the tape.

- Time code recording starts from the preset data.

Menu switch setting

No. 414 <TCG SELECT> "PRESET"
 No. 415 <TCG MODE> "REC RUN" or "FREE RUN"
 No. 416 <NON DROP/DROP> "NON DROP" or "DROP" (U MODEL)

Operation

- 1 Check the preset value.
 - Set the [COUNTER] switch to "TC" or "UB".
 - In the Stop mode, press the [REC] button.
 - Time code data is shown on the on-screen display and counter display. On the on-screen display, the counter mode is shown as "TCG" or "UBG".
 - Release your finger from the [REC] button to restore the previous display.
- 2 Start recording.
 - While pressing the [REC] button, press the [PLAY] button.
 - Time code and user bits are recorded.
 - To stop recording, press the [STOP] button.

Playback

Operation

- 1 Select the time code data to be displayed.
 - Set the [COUNTER] switch to "TC" or "UB".
 - The counter display shows the time code or user bits.
- 2 Press the [PLAY] button to play back the time code and user bits.
 - LTC time code is output from the rear panel's [TIME CODE OUT] connector. VITC time code is not output.
 - The time code data is shown on the on-screen display and counter display. On the on-screen display, the counter mode is shown as "TCR" or "UBR".
 - To stop playback, press the [STOP] button.

- Time code recording follows the time code already recorded on the tape.

Menu switch setting

No. 414 <TCG SELECT> "REGEN"
 No. 415 <TCG MODE> "REC RUN" or "FREE RUN"
 No. 416 <NON DROP/DROP> "NON DROP" or "DROP" (U MODEL)

Operation

- 1 Start recording.
 - While pressing the [REC] button, press the [PLAY] button.
 - The time code and user bits are recorded following the data recorded on the tape.
 - The time code data is shown on the on-screen display and counter display. On the on-screen display, the counter mode is shown as "TCR" or "UBR".
 - To stop recording, press the [STOP] button.

Reference

Playback time code

Time code data is recorded in the sub code area of the tape. During playback, the data in the sub code area is processed in the LTC time code format and output to the [TIME CODE OUT] connector.

Note on time code playback without user bits

- When you play back a tape that has no user bits recorded (for example, a tape recorded on a consumer MiniDV VCR), the user bits that were played back last will be displayed.

10 SUPER SCENE FINDER FUNCTION

The SSF data recorded on the tape with the GY-DV500U's Super Scene Finder function can be read out by installing the optional SA-K46 RS-232C interface board. Consult your JVC dealer for details on installation of the SA-K46 RS-232C interface board.

Preparation

Connect the 9-pin D-sub connector of the installed SA-K46 RS-232C interface board to a personal computer, etc. with an RS-232C cable.

Use a reverse type cable. For RS-232C interface settings, refer to "RS-232C specifications" on page 32. Set the No. 050 <REMOTE SELECT> menu switch to "RS232C", "IEEE 1394+ RS232C", "JVC BUS + RS232C" or "JVC BUS + RS232C + 1394".

Reading out SSF data

- 1 Insert the tape on which SSF data is recorded.
- 2 Transmit the RS-232C command D5h: SSF DATA SENSE from a personal computer or a non linear editing system.
—The SSF data is returned from the VCR.

(Display example)

```
START
ID
REEL NO.
SCENE MARK IN MARK OUT CUE
001 M 00:00:00:16 00:00:04:19
002 M 00:00:06:03 00:00:08:08
003 C 00:03:15:17 00:03:57:00
004 C 00:03:56:18 00:05:37:24 00:04:00:21
004 C 00:03:56:18 00:05:37:24 00:04:07:22
004 C 00:03:56:18 00:05:37:24 00:04:18:23
END
```

Note:

- When a tape is recorded from the beginning in this unit, recorded SSF data is erased.

Super Scene Finder (SSF) data

SSF data includes the following items.

SSF data

1. **Model ID data**
Unique identification code of the recording VCR
2. **Reel No.**
Cassette tape number
3. **Mark in point data**
Time code data at the start point specified by pressing the [TAKE] button during shooting in the Mark mode on the GY-DV500
4. **Mark out point data**
Time code data at the end point specified by pressing the [TAKE] button during shooting in the Mark mode on the GY-DV500
5. **Cue point data**
Time code data at the cue points the GY-DV500 starts and ends recording and the cue point specified by pressing the [TAKE] button during shooting in the Cue mode.

Usage example

You can use SSF data to build a database that will enable you to manage your library of original recordings more efficiently.

- 1 By creating a table linking the model ID and reel No. to the recording's title, you can easily search and retrieve a tape.

Recordings

Model ID	Reel No.	Recording title
0001	0222	'99 athletic meeting
0002	0100	'99 spring excursion
0003	0150	'99 Christmas party
:	:	:

← Search

For example, when you retrieve "99 spring excursion", the model ID (0002) and the reel No. (0100) are also provided. Please note that this function is not provided. The table must be developed by the user.

- 2 Based on the "mark in point data", "mark out point data" and "cue point data" specified with the GY-DV500's Super Scene Finder function, you can create batch capture data for a non-linear editing system (Canopus' DVReX-RT or Casablanca). This allows you to automatically acquire only specified scenes. Batch capture data conversion software for Canopus' DVReX-RT is distributed at no charge on the Internet (as of February, 2000).

11 RS-232C INTERFACE

11-1 Command tables

This section provides information on programming VCR operations via the RS-232C interface.

Basic table

0	1	2	3	4	5	6	7	8	9	A	B	C	D	E	F
			DATA '0'	ENTER						STANDBY ON					TC DATA PRESET
1	COMPLETION		DATA '1'	CLEAR ERROR						STANDBY OFF					TC UB DATA PRESET
2	ERROR		DATA '2'	CUE UP WITH DATA						PREROLL	CUE UP WITH DATA				COUNTER RESET
3	CASSETTE OUT		DATA '3'							EJECT					
4			DATA '4'									FULL EE ON			
5	NOT TARGET		DATA '5'								F-SHUTTLE	FULL EE OFF	SSF DATA SENSE		
6			DATA '6'		CLEAR						R-SHUTTLE		PREROLL TIME SENSE	PREROLL TIME PRESET	JVC TABLE 1 ON
7			DATA '7'				STATUS SENSE						STATUS SENSE	TIMER MODE SELECT	JVC BASIC TABLE ON
8			DATA '8'										CURRENT TC SENSE		
9			DATA '9'										CURRENT CTL SENSE		
A	ACK	PLAY	REV X1									REC PAUSE			REC/DUB REQUEST
B	NAK	FWD X2	REV X2							FF		REC PAUSE			VTR IND
C		FWD X0.2	REV X0.2							REW		A.DUB PAUSE	CURRENT TC UB SENSE		
D		F-STILL	R-STILL							F-FIELD STEP		A.DUB PAUSE	JVC STATUS SENSE	MEMORY SW PRESET	
E		FWD X10	REV X10					DATE PRESET		R-FIELD STEP		DATE SENSE			
F		STOP	STILL					TIME PRESET				TIME SENSE			

JVC table-1

0	1	2	3	4	5	6	7	8	9	A	B	C	D	E	F
			DATA '0'	ENTER						STANDBY ON					
1	COMPLETION		DATA '1'	CLEAR ERROR			ROM VERSION			STANDBY OFF				DEVICE TYPE	
2	ERROR		DATA '2'							PREROLL	CUE UP AND PLAY WITH DATA			COUNTER RESET	
3	CASSETTE OUT		DATA '3'							EJECT				MEMORY SW SENSE	
4			DATA '4'									FULL EE ON	TAPE REMAIN SENSE		
5	NOT TARGET		DATA '5'								F-SHUTTLE	FULL EE OFF			
6			DATA '6'		CLEAR						R-SHUTTLE				JVC TABLE 1 ON
7			DATA '7'				STATUS SENSE						STATUS SENSE	TIMER MODE SELECT	JVC BASIC TABLE ON
8			DATA '8'										CURRENT TC SENSE		
9			DATA '9'										CURRENT CTL SENSE		
A	ACK	PLAY										REC			REC/DUB REQUEST
B	NAK						OPERATE ON			FF		REC PAUSE			VTR IND
C							OPERATE OFF			REW		A.DUB			
D										F-FIELD STEP		A.DUB PAUSE	JVC STATUS SENSE	MEMORY SW PRESET	
E								DATE PRESET		R-FIELD STEP		DATE SENSE			
F			STOP	STILL				TIME PRESET				TIME SENSE			

11 RS-232C INTERFACE

11-2 RS-232C specifications

9PIN D-Sub

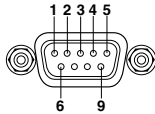

Pin NO.	Signals	Operations	Direction of signals
2	RXD	Receive data	VTR ← PC
3	TXD	Transmit data	VTR → PC
4	DTR	Data terminal ready	VTR → PC
5	GND	Signal ground	
6	DSR	Data set ready	VTR ← PC

Note: PC means a controller such as a personal computer.

Mode : Non-synchronous
 Character length : 8 bits
 Parity check : None
 Start bit : 1
 Stop bit : 1
 Data rate : 9600 bps
 Bit structure

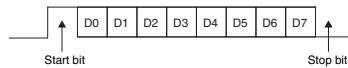

ASCII code table

Use this table to express the values or alphabets on the RS-232C interface.

	0	1	2	3	4	5	6	7	8	9	A	B	C	D	E	F
0		SP	0		P		p									
1		1	A	Q	a	q										
2		2	B	R	b	r										
3		3	C	S	c	s										
4		4	D	T	d	t										
5		5	E	U	e	u										
6		6	F	V	f	v										
7		7	G	W	g	w										
8		8	H	X	h	x										
9		9	I	Y	i	y										
A			J	Z	j	z										
B			K		k											
C			L		l											
D			M		m											
E			N		n											
F			O		o											

11 RS-232C INTERFACE

11-3 RS-232C commands

An optional RS-232C interface can be installed in this unit and connected to a personal computer. Data transmitted and received via the RS-232C interface enables the PC to control the VCR and gather status and operating information.

Preparation

To control the VCR via the RS-232C interface, set the No. 050 <REMOTE SELECT> menu switch to "RS232C", "IEEE 1394 + RS232C", "JVC BUS + RS232C" or "JVC BUS + RS232C + 1394".

VCR operation commands

These commands are used to operate the VCR. When the command is received correctly, the VCR returns ACK (0Ah) and enters the mode corresponding to the command.

(e.g.) TXD / 3Ah
 Playback RXD 0Ah

Commands	Description
3A PLAY	Play
3B FWD X2	2x play
3C FWD X0.2	0.2x play
3D F-STILL	Pause
3E FWD X10	10x play
3F STOP	Stop
4A REV X1	Reverse play
4B REV X2	2x reverse play
4C REV X0.2	0.2x reverse play
4D R-STILL	Pause
4E REV X10	10x reverse play
4F STILL	Pause
7B OPERATE ON	Operating mode ON
7C OPERATE OFF	Operating mode OFF
A0 STANDBY ON	Standby ON
A1 STANDBY OFF	Standby OFF
A2 PREROLL	Preroll
A3 EJECT	Eject cassette
AB FF	Fast-forward. When this command is transmitted during playback, playback speed changes to 10x.
AC REW	Rewind. When this command is transmitted during playback, reverse playback starts at 10x.
AD F-FIELD STEP	Advances one frame. This command should be transmitted in the Play-Pause mode.
AE R-FIELD STEP	Reverses one frame. This command should be transmitted in the Play-Pause mode.
B2 CUE UP WITH DATA	Use this command to cue up a specified point on the tape. When the tape is cued, COMPLETION is returned and the Pause mode is engaged. To specify the cue point, transmit the time data (hour: minute: second: frame, a total of 8 bytes with 2 bytes for each) following this command.
B3 CUE UP AND PLAY WITH DATA	Use this command to cue up a specified point on the tape. When the tape is cued, COMPLETION is returned and the Play mode is engaged. To specify the cue point, transmit the time data (hour: minute: second: frame, a total of 8 bytes with 2 bytes for each) following this command.
B5 F-SHUTTLE	Shuttle play. The search speed is specified by sending the speed code data after this command (see the table below).

Speed code table (corresponding speed)

Speed code	Search speed
30h	Still
31h	0.1
33h	0.2
34h	0.3
35h	1
36h	2
37h	5
38h	10

11 RS-232C INTERFACE

Commands	Description
B6 R-SHUTTLE	Shuttle reverse play. The search speed is specified by sending the speed code data after this command (see the table above).
C4 FULL EE ON	Full EE mode ON
C5 FULL EE OFF	Full EE mode OFF
CA REC	Record. Transmit this command after transmitting REC DUB REQUEST.
CB REC PAUSE	Record pause. Transmit this command after transmitting REC DUB REQUEST.
CC A. DUB	Audio dubbing. Transmit this command during playback after transmitting REC DUB REQUEST.
CD A. DUB PAUSE	Audio dubbing pause. Transmit this command during audio dubbing after transmitting REC DUB REQUEST.
E2 COUNTER RESET	Counter reset
FA REC REQUEST	Recording request (use with the recording-related command).

Information gathering (sense) commands

These commands are used to check the VCR operation conditions. When a command requesting information is received by the VCR, data is returned in 1-byte packets corresponding to the information requested. The number of bytes returned differs depending on the command.

Commands	Description
72 ROM VERSION	Use to check the RS-232C interface-related ROM version. 3-byte data is returned.
BE DATE SENSE	Use to check the VCR's date data. The data is returned in order of month, day and year. During playback, the time data on the tape is returned.
BF TIME SENSE	Use to check the VCR's time data. The data is returned in order of hour, minute and second. During play, the time data on the tape is returned.
D1 DEVICE TYPE	Use to check the device type. D:44h, V:55h, 6:36h, 0:30h
D4 TAPE REMAIN SENSE	Use to check the tape remaining time. 3-byte data is returned showing the hour (ones place) and minutes (tens place and ones place).
D5 SSF DATA SENSE	Use to check the Super Scene Finder data.
D6 PREROLL TIME SENSE	Use to check the preroll time. 2-byte data is returned showing the seconds (tens place and ones place).
D7 STATUS SENSE	Use to check the status. Refer to the contents of the STATUS SENSE.
D8 CURRENT TC SENSE	Use to check the time code data. The data is returned in the order of hour, minute, second and frame.
D9 CURRENT CTL SENSE	Use to check the CTL data. The uppermost digit shows plus or minus.
DC CURRENT TC UB SENSE	Use to check the user bits data. Data A from F is expressed with ASCII code 41h to 46h.
DD JVC STATUS SENSE	Use to check the status. Refer to JVC STATUS SENSE for details.
FB VTR IND	Use to check the VCR connection.

11 RS-232C INTERFACE

Setting (preset) commands

These commands activate various settings on the VCR. When a command is sent, the corresponding setting is activated.

Commands	Description
E0 TC DATA PRESET	Use to preset the time code data. To set, transmit the time data following this command. Specify the time in order of hour, minute, second and frame, using two digits for each item. When ENTER (40h) is transmitted before all digits have been transmitted, the time code data can be specified by entering digits from the uppermost digit. Set the VCR's [REMOTE] switch to "REMOTE".
E1 TC UB DATA PRESET	Use to preset the user bits.
E6 PREROLL TIME PRESET	Use to set the preroll time. Specify this by transmitting 2-byte data following this command. First byte for ten place and second byte for one place.
E7 TIMER MODE SELECT	Use to select the counter mode. Following this command, send data (1 byte) corresponding to the counter mode.

High	Low	Counter mode
3 (fixed)	1	TC
	2	CTL
	5	UB

8E DATE PRESET	Use to set the date. Following this command, send 6-byte numeric data. Specify the month, day and year in order with two digits for each.
8F TIME PRESET	Use to set the date. Following this command, send 6-byte numeric data. Specify the hour, minute and second in order with two digits for each.

11 RS-232C INTERFACE

Contents of STATUS SENSE

When the STATUS SENSE (D7H) command is sent, the following data (5 bytes) is returned.

First byte

Bit No.	Status	When the bit is 1
7	Always 1	
6	Always 0	
5	SHORT FF/REW	During short FF or short REW
4	REC INHIBIT	Recording is inhibited.
3	CASSETTE OUT	There is no cassette loaded.
2	SERVO LOCK	Servo is locked.
1	Undefined	Always 0
0	ERROR	An error has occurred.

Second byte

Bit No.	Status	When the bit is 1
7	VIDEO EE	Video output is EE.
6	AUD 1 EE	Audio 1 output is EE.
5	VIDEO MUTE	Always 0
4	AUD 1 MUTE	Always 0
3	WARNING	There is a problem with the VCR.
2	DEW	Condensation has formed in the VCR.
1	TAPE BEGIN	Short FF at the tape beginning
0	TAPE END	Short REW at the tape end

Third byte

Bit No.	Status	When the bit is 1
7	TIMER PLAY	The [TIMER] switch is set to "PLAY".
6	TIMER REC	The [TIMER] switch is set to "REC".
5	Unused	Always 0
4	Unused	Always 0
3	Unused	Always 0
2	Unused	Always 0
1	SEARCH MODE	The VCR is in the Search mode
0	Unused	Always 0

Fourth byte

Bit No.	Status	When the bit is 1
7	PLAY MODE	The VCR is playing back a tape.
6	FF MODE	The VCR is fast-forwarding a tape.
5	REW MODE	The VCR is rewinding a tape.
4	STOP MODE	The VCR is in the Stop mode.
3	STANDBY MODE	The VCR is on standby.
2	EJECT	A cassette is being ejected.
1	REC MODE	The VCR is recording on a tape
0	Unused	Unused

Fifth byte

Bit No.	Status	When the bit is 1
7	PAUSE MODE	The VCR temporarily stops.
6	Unused	Always 0
5	SHUTTLE FWD	The VCR is shuttle-searching in the forward direction.
4	SHUTTLE REV	The VCR is shuttle-searching in the reverse direction.
3	SPEED CODE 3	Speed code 3
2	SPEED CODE 2	Speed code 2
1	SPEED CODE 1	Speed code 1
0	SPEED CODE 0	Speed code 0

Search speed table (corresponding speed only)

Search speed	Speed code (bit No.)			
	3	2	1	0
STILL	0	0	0	0
0.1	0	0	1	0
0.2	0	0	1	1
0.3	0	1	0	0
1	0	1	0	1
2	0	1	1	0
5	0	1	1	1
10	1	0	0	1

11 RS-232C INTERFACE

Contents of JVC STATUS SENSE

When the STATUS SENSE (DDH) command is sent, the following data (4 bytes) is returned.

First byte

Bit No.	Status	When the bit is 1
7	Always 1	
6	Always 0	
5	Unused	Always 0
4	DMF	Always 0
3	Unused	Always 0
2	JVC TABLE 2	JVC TABLE 2 is effective.
1	JVC TABLE 1	JVC TABLE 1 is effective.
0	LOCAL	The [REMOTE] switch is set to "LOCAL".

Second byte

Bit No.	Status	When the bit is 1
7	TC GENERATOR	The time code generator is in the TCG mode.
6	USERS BIT	The counter mode is set to the UB mode.
5	TIME CODE	The counter mode is set to the TC mode.
4	CTL PULSE	The counter mode is set to the CTL mode.
3	CTL interpolation	Always 0
2	DROP FRAME	The current time code is set to the Drop Frame mode (U MODEL). Always 0 (E MODEL)
1	LTC	Always 0
0	Unused	

Third byte

Bit No.	Status	When the bit is 1
7	TC REC RUN	The TCG is set to the Rec Run mode.
6	TC REGEN	The TCG is set to the REGEN mode.
5	TC EXTERNAL	Always 0
4	TC INSERT LED	Always 0
3	AUD 2 INSERT LED	Always 0
2	AUD 1 INSERT LED	Always 0
1	VIDEO INSERT LED	Always 0
0	ASSEM LED	Assemble mode

Fourth byte

Bit No.	Status	When the bit is 1
7	TBC PWB IN	Always 1
6	TC PWB IN	Always 1
5	DA3 INSERT LED	Always 0
4	DA4 INSERT LED	Always 0
3	AUTO MODE	Always 0
2	Unused	Always 0
1	Unused	Always 0
0	Unused	Always 0

Error-related commands

This command is returned when transmitted data cannot be received normally by the VCR. A command to release the error status is also available.

Command	Description
02	ERROR: Returned when the VCR receives an invalid command after the second byte of the transmitted command. In this case, even though commands are sent continuously, no commands can be accepted except STATUS SENSE. To release this error mode, send the following commands.
41	CLEAR ERROR: Clears the last transmitted byte. Use this to release the error mode as well.
56	CLEAR: All commands are canceled. This is also used to release the error mode.
0B	NAK: Returned when the VCR receives an undefined command for the first byte or a command specifying a function not available on the VCR. Releasing the error mode with the CLEAR command is not necessary. Just send a correct command.

* Usage example of CLEAR ERROR
Specify the cue-up point at 1:10:10:25.

As this data cannot be specified for the data following the CUE UP WITH DATA, correct the data.

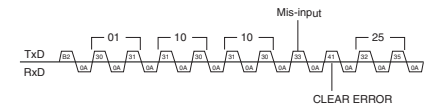

11 RS-232C INTERFACE

Menu switch setting command

ED MEMORY SW PRESET

Use this command to change the VCR's menu switches. Transmit the data (3 bytes) corresponding to the menu switch to be changed, following this command.

(e.g.)

Set No. 108 <VIDEO INPUT SELECT> menu switch to "COMPONENT".

As can be seen in the table on the right, the data corresponding to COMPONENT is DATA0 at 02, D2's bit No. 5 at 1 and bit No. 4 at 0.

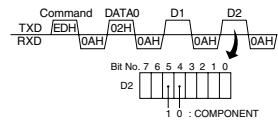

Menu switch check command

D3 MEMORY SW SENSE

Use this command to check the VCR's menu switch setting. Following this command, transmit the data (DATA0) corresponding to the menu switch to be checked.

You can confirm the setting with the returned data (D1, D2).

(e.g.)

Check the No. 108 <VIDEO INPUT SELECT> menu switch setting.

As can be seen in the table on the right, the data corresponding to DATA0 of the menu switch to be checked is 02. You can confirm the setting with the values for bit No. 5 and 4 of the D2 returned data.

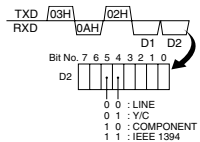

11 RS-232C INTERFACE

Menu switch No.	DATA0	D1/D2	Set value	Corresponding bit values																	
				7	6	5	4	3	2	1	0										
002	01	D1	OFF																		
003	01	D2	INTERNAL																		
			EXTERNAL																		
			VIDEO																		
			AUTO																		
050	93	D2	IEEE1394	0	0	0	1	0	0	0	0										
			RC232C	0	0	1	0	0	0	0	0										
			IEEE1394+RS232C	0	0	1	1	0	0	0	0										
			RS422A	0	1	0	0	0	0	0											
			IEEE1394+RS422A	0	1	0	1	0	0	0											
			JVC BUS	1	0	0	0	0	0	0											
			JVC BUS+IEEE1394	1	0	0	1	0	0	0											
			JVC BUS+RS232C	1	0	1	0	0	0	0											
108	02	D2	LINE																		
			Y/C																		
			COMPONENT																		
			IEEE1394																		
125 (U MODEL)	02	D2	OFF																		
212	05	D1	OFF																		
			ON																		
214	05	D1	OFF																		
			ON																		
245	03	D2	32K																		
			48K																		
311	10	D2	SHORT FF																		
			PLAY																		
312	08	D1	OFF																		
			ON																		
353	89	D1	0F																		
			1F																		
			2F																		
			3F																		
			4F																		
			5F																		
			6F																		
7F																					
360	90	D1	OFF																		
			ON																		
363	90	D2	TYPE 1																		
			TYPE 2																		
			TYPE 3																		
			TYPE 4																		
			TYPE 5																		
			TYPE 6																		
			TYPE 7																		
396	91	D2	12V																		
			13.2V																		
			14.4V																		
397	91	D2	ENABLE																		
			DISABLE																		
414	81	D2	PRESET																		
			REGEN																		
415	81	D2	FREE RUN																		
			REC RUN																		
416 (U MODEL)	81	D2	DROP																		
			NON DROP																		
500	01	D1	OFF																		
			ON																		
501	82	D1	0																		
			1																		
			2																		
			3																		
			4																		
			5																		
			6																		
			7																		
8																					

Menu switch No.	DATA0	D1/D2	Set value	Corresponding bit values																
				7	6	5	4	3	2	1	0									
502	82	D1	0																	
			1																	
			2																	
			3																	
			4																	
			5																	
			6																	
			7																	
			8																	
			9																	
			10																	
504	82	D2	TIME																	
			MODE+TIME																	
505	82	D2	OFF																	
			ON																	
514	83	D2	DATE																	
			CLOCK																	
			DATE+CLOCK																	
516	83	D2	TC																	
			CLOCK																	

12 TROUBLESHOOTING

12-1 Warning indicators

If the unit malfunctions during operation, the built-in self-diagnostics system identifies the problem and displays a warning message on the monitor and/or the counter display. Also, the [AUTO OFF] indicator may be shown on the LCD. In this case, turn the power off and then on again to restore operation. If the [AUTO OFF] indicator appears again, the VCR may require repair or adjustment. Consult your local JVC dealer.
The VCR's built-in microprocessor is susceptible to interference from externally generated noise or electro-magnetism. In this case, turn the main power (AC and DC power supplies) off, turn on again and check the operation.

On-screen display Counter display	Error contents	Operation	Solution
CONDENSATION ON DRUM The [DEW] indicator lights.	Condensation on the drum.	<ul style="list-style-type: none"> When a cassette is not loaded, the drum starts to rotate. When a cassette is loaded, the AUTO OFF mode is engaged and the operation stops. 	<p>Wait for the drum to stop rotating, then load a cassette.</p> <p>Do not use the unit until the AUTO OFF mode is disengaged.</p>
FAILURE LOADING Err 3200	Tape cannot be loaded.	Operation stops. No operations are possible.	Turn the power on again. In some cases, the tape may be damaged, so use a different tape. If the problem persists, consult your JVC dealer.
FAILURE UNLOADING Err 3300	<ul style="list-style-type: none"> Tape cannot be unloaded. Tape is jammed. 		
CASSETTE EJECT FAILURE Err 4100	The eject operation is abnormal.		
HOUSING FAILURE Err 4200	The cassette housing is abnormal.		
TAPE DEFECTIVE Err 5605	The tape ends.		
TAPE DEFECTIVE Err 5607	The tape is slack.		
END LEADER DETECTION Err 5702	The tape end sensor is abnormal.		
BEGIN LEADER DETECTION Err 5802	The tape beginning sensor is abnormal.		
DRUM MOTOR FAILURE Err 7001	The drum rotation stops.		
CAP MOTOR FAILURE Err 7101	The capstan rotation stops.		

12 TROUBLESHOOTING

On-screen display Counter display	Error contents	Operation	Solution
SUP REEL FAILURE Err 7202~7203	The supply reel rotation is abnormal.	Operation stops. No operations are possible.	In some cases, the tape may be damaged, so use a different tape. If the problem persists, consult your JVC dealer.
TAKE UP REEL FAILURE Err 7302~7303	The takeup reel rotation is abnormal.		
SYSCON REF ERROR Err 8400	System controller reference signal failure.	Operation stops. No operations are possible.	Turn the power on again.
PC TAPE INHIBIT Pc TAPE	A data tape for personal computer is used.	Operation continues.	Use a tape on which NTSC (U MODEL), PAL (E MODEL) signals are recorded.
LP INHIBIT LP inh	A tape recorded in the LP mode is played back.	Operation stops.	Use a tape recorded in the SP mode.
REC INHIBIT rEc inh	The cassette's safety slide is set to "SAVE". Copy-guarded signals are input.	Operation stops.	Set the safety slide to "REC". Copy-guarded signals cannot be recorded.
1394 INHIBIT 1394 inh	No signal is input to the [DV IN/OUT] connector. Copy-guarded signals are input.	Operation stops.	Input signals to the [DV IN/OUT] connector. Copy-guarded signals cannot be recorded.
EE CHECK INHIBIT EE inh	When the IEEE 1394 input is selected, the EE check is performed.	Operation continues.	When the IEEE 1394 input is selected, the EE check cannot be performed.
AUDIO DUB INHIBIT Adb inh	The cassette's safety slide is set to "SAVE". The tape was recorded with the 48 kHz sampling rate. The No. 245 <SAMPLING RATE> menu switch is set to "48K". Audio dubbing was attempted on a tape recorded in the LP mode.	Operation stops.	Set the safety slide to "REC". Use a tape recorded at the 32 kHz sampling rate. Set the No. 245 <SAMPLING RATE> menu switch to "32K". Audio dubbing cannot be performed on tapes recorded in the LP mode.
SSF INHIBIT SSF inh	SSF data error occurs.	Operation continues.	Use a tape on which SSF data has been properly recorded.
FAN MOTOR FAILURE FAn StOP	The fan motor stops.	Operation stops about 60 seconds after the fan motor stops (with the No. 397 <FAN STOP SHUTDOWN> menu switch set to "ENABLE").	Consult your nearest JVC dealer.
HEAD CLOG HEAd CLoG	The video head is clogged.	The operation continues.	Clean with a dedicated head cleaning tape. Refer to the separate enclosure, "Notes on the use of a cleaning tape".

12 TROUBLESHOOTING

12-2 Other problems

Symptoms	Causes	Action
The VCR's controls are not functioning.	<ul style="list-style-type: none"> The [REMOTE] switch is set to "REMOTE". The No. 002 <OPERATION LOCK> menu switch is set to "ON". 	<ul style="list-style-type: none"> Set the [REMOTE] switch to "LOCAL". Set the No. 002 <OPERATION LOCK> menu switch to "OFF".
On-screen display does not come up.	<ul style="list-style-type: none"> The monitor is not connected to the [MONITOR OUT] connector. The No. 500 <ON SCREEN> menu switch is set to "OFF". 	<ul style="list-style-type: none"> Connect the monitor to the [MONITOR OUT] connector. Set the No. 500 <ON SCREEN> menu switch to "ON".
Noise appears on parts of the playback picture.	<ul style="list-style-type: none"> The heads are dirty. 	<ul style="list-style-type: none"> Read the instructions on page 5 and clean the heads.
Tape counter does not run.	<ul style="list-style-type: none"> The counter does not run on a non-recorded section of the tape. The menu switch setting mode is engaged. 	<ul style="list-style-type: none"> Press the [MENU] button and restore the normal mode.

13 APPENDIX

13-1 Optional equipment

SA-K46 RS-232C interface board

With this board connected to this unit and a personal computer, you can control the VCR from a personal computer. Use a reverse-type cable. For installation and uninstallation, consult your JVC dealer.

RM-G30 wired remote control

This remote control allows you to control all basic VCR operations such as PLAY, RECORD, PAUSE, FF, etc.

YC video cables

These cables are used to transmit YC video signals. The following types are available.

Types	Input	Output	Length
VC-G30U	4-pin	4-pin	3 m
VC-G50U	4-pin	4-pin	5 m
VC-G3030	4-pin	7-pin	3 m
VC-G2030	7-pin	4-pin	3 m
VC-G2050	7-pin	4-pin	5 m

VC-G8030U remote extended cable

This extended cable is for use with the RM-G800 remote controllers. The cable length is 3 m.

14 SPECIFICATIONS

General

- **Power requirements** : AC 120 V (U MODEL), AC 220 – 240 V (E MODEL), 50/60 Hz, DC 12 V (10.5 V to 17 V)
- **Power consumption** : 27 W (U MODEL), 250 mA (E MODEL)
- **Dimensions** : (W) 212 mm x (H) 88 mm x (D) 325 mm (8-3/8" x 3-1/2" x 12-13/16")
- **Weight** : Approx. 3.6 kg (7.9 lbs.)
- **Temperature** : Operating : 5°C to 40°C (41°F to 104°F), Storage : -20°C to 60°C (-4°F to 140°F)
- **Humidity** : Operating : 30% to 80% RH
- **Format** : MiniDV format
- **Signal format** : NTSC
- **Usable tape** : MiniDV tape
- **Tape width** : 6.35 mm
- **Tape speed** : 18.812 mm/s (SP mode) (U MODEL), 18.831 mm/s (SP mode) (E MODEL)
- **Record/play time** : 60 minutes (with an M-DV60ME tape, only in the SP mode)
- **FF/rewind time** : Within 120 s (with an M-DV60ME tape)

[Video]

- **Video signal recording format** : 8-bit, 13.5 MHz, 4:1:1 component recording (U MODEL), 8-bit, 13.5 MHz, 4:2:0 component recording (E MODEL)
- **Video inputs** : Analog composite : 1.0 V (p-p), 75 Ω, Analog Y/C : Y : 1.0 V (p-p), 75 Ω, C : 0.286 V (p-p), 75 Ω (U MODEL), 0.3 V (p-p), 75 Ω (E MODEL), Analog component: Y: 1.0 V (p-p), 75 Ω, R-Y/B-Y: 0.7 V (p-p), 75 Ω
- **External sync input** : 1.0 V (p-p), 75 Ω
- **Video output** : Analog composite : 1.0 V (p-p) (setup can be switched ON/OFF with a menu switch), 75 Ω, Analog Y/C : Y : 1.0 V (p-p) (setup can be switched ON/OFF with a menu switch), 75 Ω, C : 0.286 V (p-p), 75 Ω (U MODEL), 0.3 V (p-p), 75 Ω (E MODEL), Analog component: Y: 1.0 V (p-p) (setup can be switched ON/OFF with a menu switch), 75 Ω, R-Y/B-Y: 0.7 V (p-p), 75 Ω
- **Horizontal resolution** : 500 lines or more

[Audio]

- **Audio signal recording format** : 16-bit, 48 kHz for two channels or 12-bit, 32 kHz PCM for four channels
- **Frequency response** : 20 Hz to 20 kHz (48 kHz, 16 bits)

■ Audio input

- Line : -8 dBs, 10 kΩ, unbalanced
- Mic : -67 dBs, 3 kΩ, unbalanced

■ Audio output

- Line : -8 dBs, 1 kΩ, unbalanced
- Headphone : - infinity to -17 dBs, 8 Ω, unbalanced

[Time code]

- **Output** : 0 ± 3 dBs, low impedance, unbalanced

[DV interface]

- **Input/output: IEEE 1394**

[Connectors]

- **RS-422 interface** : D-sub 9-pin
- **JVC bus connector** : DIN 12-pin

Accessory

- AC cable x 1

Option

- SA-K46U RS-232C interface board

Design and specifications subject to change without notice.

Dimensions (unit: mm)

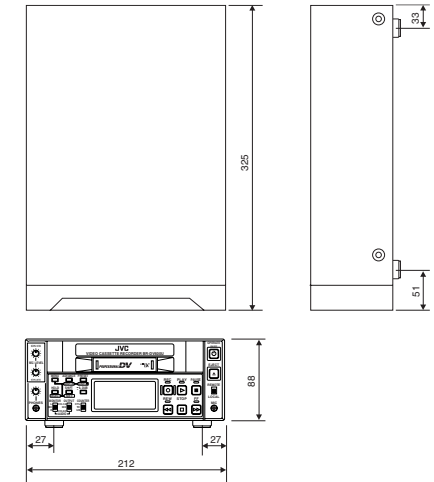

Note: (U MODEL)

When setting menu switch No.108 [VIDEO INPUT SELECT] to IEEE1394 even if menu switch No.125 [SET UP] is set to on position, set up signals will not be provided to DV output and analog output.

If you would like to provide set up signals when playback, set menu switch No.108[VIDEO INPUT SELECT] to LINE or Y/C or COMPONENT position (except IEEE1394).

PRX47531

Precautions for Use of Head Cleaning Tape **English**

Adhere to the following precautions when using the head cleaning tape.

1. The tape runs for 10 seconds at a time in the PLAY mode. (The tape stops automatically.)
Press the PLAY button after the cleaning tape is fully loaded.
2. Do not use the tape more than four times at the most for each cleaning.
3. The cleaning tape can be used four times.
One time: One tape transport from the start of the rewound tape to the end of the tape.

■ Use the following chart as a guide for periodical head cleaning.

Operating environment	Low temperature 5°C to 10°C	Room temperature 10°C to 35°C	High temperature 35°C to 40°C
Yardstick for use of cleaning tape	1 to 2 times every 5 hours	1 to 2 times every 20 to 30 hours	1 to 2 times every 5 hours

Note 1) When used in a low humidity environment (10% RH to 30% RH), head cleaning should be conducted at intervals half of those given in the above chart.

Note 2) When an ME80 tape is used immediately after head cleaning, the VTR warning (head) indicator may remain on. In this case, let the tape run as the indicator will turn off after the tape has run for a while.

Note 3) Use the cleaning tape in the room temperature (10°C to 35°C).

Note 4) The cleaning tape case contains instructions for use of the cleaning tape. However, some of these instructions differ from the contents of this sheet. When using the cleaning tape, please follow the instructions of this sheet.

SL96190

Vorsichtshinweise für die Verwendung des Kopfreinigungsbandes **Deutsch**

Bitte beachten Sie bei der Verwendung des Kopfreinigungsbandes die folgenden Vorsichtshinweise.

1. Das Band läuft jeweils 10 Sekunden lang in Wiedergabemodus (PLAY). (Das Band hält automatisch an.)
Drücken Sie die Taste PLAY, nachdem das Reinigungsband vollkommen geladen worden ist.
2. Verwenden Sie das Band nicht mehr als maximal viermal für jede Reinigung.
3. Das Reinigungsband kann viermal verwendet werden.
Einmal: Ein Bandtransport vom Anfang des zurückgespulten Bandes zum Bandende.

■ Verwenden Sie das folgende Diagramm als Anhalt für periodische Kopfreinigung.

Betriebsumgebung	Niedrige Temperatur 5°C bis 10°C	Raumtemperatur 10°C bis 35°C	Hohe Temperatur 35°C bis 40°C
Maßstab für die Verwendung des Reinigungsbandes	Ein- bis zweimal alle 5 Stunden	Ein- bis zweimal alle 20 bis 30 Stunden	Ein- bis zweimal alle 5 Stunden

Hinweis 1) Bei Verwendung in einer Umgebung mit niedriger Luftfeuchtigkeit (10% bis 30% relativ) sollte Kopfreinigung doppelt so oft wie im obigen Diagramm angegeben durchgeführt werden.

Hinweis 2) Wenn direkt nach dem Kopfreinigen ein ME80-Band verwendet wird, so bleibt die Warnanzeige für den Videorekorder (Kopf) möglicherweise an. Lassen Sie in diesem Fall das Band laufen, da die Anzeige ausgeht, nachdem das Band einige Zeit gelaufen ist.

Hinweis 3) Verwenden Sie das Reinigungsband bei Zimmertemperatur (10°C bis 35°C).

Hinweis 4) Das Gehäuse des Reinigungsbandes enthält Anweisungen für die Verwendung des Reinigungsbandes. Einige dieser Anweisungen unterscheiden sich jedoch vom Inhalt dieses Blattes. Bitte befolgen Sie bei der Verwendung des Reinigungsbandes die Anweisungen auf diesem Blatt.

Précautions lors de l'utilisation de la cassette de nettoyage de têtes **Français**

Respectez les précautions suivantes lors de l'utilisation de la cassette de nettoyage de têtes.

1. La cassette défile pendant 10 secondes chaque fois en mode de lecture. (La bande s'arrête automatiquement.)
Appuyez sur la touche de lecture (PLAY) après avoir inséré la cassette de nettoyage.
2. N'utilisez pas la cassette plus de quatre fois pour un nettoyage.
3. La bande de la cassette de nettoyage peut être utilisée quatre fois.
Une fois correspond au défilement de la bande depuis le début de la bande rebobiné jusqu'à la fin de la bande.

■ Utilisez le tableau suivant comme un guide pour les nettoyages de têtes périodiques.

Température de fonctionnement	Basse température 5°C à 10°C	Température de la pièce 10°C à 35°C	Haute température 35°C à 40°C
Étalon pour l'utilisation de la cassette de nettoyage	1 à 2 fois toutes les 5 heures	1 à 2 fois toutes les 20-30 heures	1 à 2 fois toutes les 5 heures

Remarque 1) Lors de l'utilisation de la cassette dans un environnement humide (10% HR à 30% HR), le nettoyage des têtes doit être réalisé à des intervalles correspondant à la moitié de ceux donnés dans le tableau ci-dessus.

Remarque 2) Si une cassette ME80 est utilisée immédiatement après un nettoyage de têtes, l'indicateur d'avertissement VTR (têtes) peut rester allumé. Dans ce cas, laissez la bande défiler et l'indicateur s'éteindra après que la bande a défilé quelques instants.

Remarque 3) Utilisez la cassette de nettoyage à température ambiante (10°C à 35°C).

Remarque 4) La cassette de nettoyage comprend les instructions d'utilisation de la cassette. Toutefois, certaines de ces instructions diffèrent du contenu de la présente feuille. Lors de l'utilisation de la cassette, veuillez suivre les instructions de la présente feuille.

Free Manuals Download Website

<http://myh66.com>

<http://usermanuals.us>

<http://www.somanuals.com>

<http://www.4manuals.cc>

<http://www.manual-lib.com>

<http://www.404manual.com>

<http://www.luxmanual.com>

<http://aubethermostatmanual.com>

Golf course search by state

<http://golfingnear.com>

Email search by domain

<http://emailbydomain.com>

Auto manuals search

<http://auto.somanuals.com>

TV manuals search

<http://tv.somanuals.com>