

# JVC

VICTOR COMPANY OF JAPAN, LIMITED

## VIDEO CASSETTE RECORDER

# HR-A590U

## INSTRUCTIONS

**VHS**  
**Hi-Fi**  
**SQPB**

LPT0662-001A

COPYRIGHT © 2002 VICTOR COMPANY OF JAPAN, LTD.

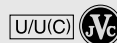

Printed in Thailand

4F21901A [K]

01/12

### Dear Customer,

Thank you for purchasing the JVC VHS video cassette recorder. Before use, please read the safety information and precautions to ensure safe use of your new VCR.

## CAUTIONS



**CAUTION**  
RISK OF ELECTRIC SHOCK  
DO NOT OPEN



**CAUTION:** TO REDUCE THE RISK OF ELECTRIC SHOCK,  
DO NOT REMOVE COVER (OR BACK).  
NO USER-SERVICEABLE PARTS INSIDE.  
REFER SERVICING TO QUALIFIED SERVICE PERSONNEL.

The lightning flash with arrowhead symbol, within an equilateral triangle, is intended to alert the user to the presence of uninsulated "dangerous voltage" within the product's enclosure that may be of sufficient magnitude to constitute a risk of electric shock to persons.



The exclamation point within an equilateral triangle is intended to alert the user to the presence of important operating and maintenance (servicing) instructions in the literature accompanying the appliance.



### WARNING:

**TO PREVENT FIRE OR SHOCK HAZARD, DO NOT EXPOSE THIS UNIT TO RAIN OR MOISTURE.**

### CAUTION:

This video cassette recorder should be used with AC 120V~, 60Hz only.

To prevent electric shocks and fire hazards, DO NOT use any other power source.

### CAUTION:

**TO PREVENT ELECTRIC SHOCK, MATCH WIDE BLADE OF PLUG TO WIDE SLOT, FULLY INSERT.**

### ATTENTION:

**POUR ÉVITER LES CHOCS ÉLECTRIQUES, INTRODUIRE LA LAME LA PLUS LARGE DE LA FICHE DANS LA BORNE CORRESPONDANTE DE LA PRISE ET POUSSER JUSQU'AU FOND.**

### Note to CATV system installer:

This reminder is provided to call the CATV system installer's attention to Article 820-40 of the NEC that provides guidelines for proper grounding and, in particular, specifies that the cable ground shall be connected to the grounding system of the building, as close to the point of cable entry as practical.

### CAUTION:

Changes or modifications not approved by JVC could void user's authority to operate the equipment.

Failure to heed the following precautions may result in damage to the VCR, Remote or video cassette.

1. **DO NOT** place the VCR . . .
  - ...in an environment prone to extreme temperatures or humidity.
  - ...in direct sunlight.
  - ...in a dusty environment.
  - ...in an environment where strong magnetic fields are generated.
  - ...on a surface that is unstable or subject to vibration.
2. **DO NOT** block the VCR's ventilation openings.
3. **DO NOT** place heavy objects on the VCR or on the Remote.
4. **DO NOT** place anything which might spill on the top of the VCR or on the Remote.
5. **AVOID** violent shocks to the VCR during transport.

### For Customer Use:

Enter below the Model No. and Serial No. which are located on the rear of cabinet. Retain this information for future reference.

Model No. \_\_\_\_\_

Serial No. \_\_\_\_\_



- Cassettes marked "VHS" (or "S-VHS") can be used with this video cassette recorder. However, S-VHS recording is not possible with this model.
- This model is equipped with SQPB (S-VHS QUASI PLAYBACK) that makes it possible to play back S-VHS recordings with regular VHS resolution.
- HQ VHS is compatible with existing VHS equipment.
- As an Energy Star® Partner, JVC has determined that this product or product model meets the Energy Star® guidelines for energy efficiency.

# IMPORTANT PRODUCT SAFETY INSTRUCTIONS

Electrical energy can perform many useful functions. But improper use can result in potential electrical shock or fire hazards. This product has been engineered and manufactured to assure your personal safety. In order not to defeat the built-in safeguards, observe the following basic rules for its installation, use and servicing.

## ATTENTION:

Follow and obey all warnings and instructions marked on your product and its operating instructions. For your safety, please read all the safety and operating instructions before you operate this product and keep this booklet for future reference.

## INSTALLATION

### 1. Grounding or Polarization

(A) Your product may be equipped with a polarized alternating-current line plug (a plug having one blade wider than the other). This plug will fit into the power outlet only one way. This is a safety feature.

If you are unable to insert the plug fully into the outlet, try reversing the plug. If the plug should still fail to fit, contact your electrician to replace your obsolete outlet. Do not defeat the safety purpose of the polarized plug.

(B) Your product may be equipped with a 3-wire grounding-type plug, a plug having a third (grounding) pin. This plug will only fit into a grounding-type power outlet. This is a safety feature.

If you are unable to insert the plug into the outlet, contact your electrician to replace your obsolete outlet. Do not defeat the safety purpose of the grounding-type plug.

### 2. Power Sources

Operate your product only from the type of power source indicated on the marking label. If you are not sure of the type of power supply to your home, consult your product dealer or local power company. If your product is intended to operate from battery power, or other sources, refer to the operating instructions.

### 3. Overloading

Do not overload wall outlets, extension cords, or integral convenience receptacles as this can result in a risk of fire or electric shock.

### 4. Power Cord Protection

Power supply cords should be routed so that they are not likely to be walked on or pinched by items placed upon or against them, paying particular attention to cords at plugs, convenience receptacles, and the point where they exit from the product.

### 5. Ventilation

Slots and openings in the cabinet are provided for ventilation. To ensure reliable operation of the product and to protect it from overheating, these openings must not be blocked or covered.

- Do not block the openings by placing the product on a bed, sofa, rug or other similar surface.
- Do not place the product in a built-in installation such as a bookcase or rack unless proper ventilation is provided or the manufacturer's instructions have been adhered to.

### 6. Wall or Ceiling Mounting

The product should be mounted to a wall or ceiling only as recommended by the manufacturer.

## ANTENNA INSTALLATION INSTRUCTIONS

### 1. Outdoor Antenna Grounding

If an outside antenna or cable system is connected to the product, be sure the antenna or cable system is grounded so as to provide some protection against voltage surges and built-up static charges. Article 810 of the National Electrical Code, ANSI/NFPA 70, provides information with regard to proper grounding of the mast and supporting structure, grounding of the lead-in wire to an antenna discharge unit, size of grounding connectors, location of antenna discharge unit, connection to grounding electrodes, and requirements for the grounding electrode.

### 2. Lightning

For added protection for this product during a lightning storm, or when it is left unattended and unused for long periods of time, unplug it from the wall outlet and disconnect the antenna or cable system. This will prevent damage to the product due to lightning and power-line surges.

### 3. Power Lines

An outside antenna system should not be located in the vicinity of overhead power lines or other electric light or power circuits, or where it can fall into such power lines or circuits. When installing an outside antenna system, extreme care should be taken to keep from touching such power lines or circuits as contact with them might be fatal.

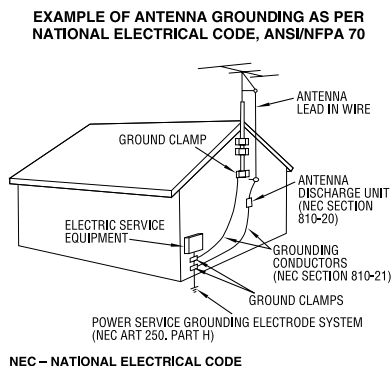

## USE

### 1. Accessories

To avoid personal injury:

- Do not place this product on an unstable cart, stand, tripod, bracket, or table. It may fall, causing serious injury to a child or adult, and serious damage to the product.
- Use only with a cart, stand, tripod, bracket, or table recommended by the manufacturer or sold with the product.
- Use a mounting accessory recommended by the manufacturer and follow the manufacturer's instructions for any mounting of the product.
- Do not try to roll a cart with small casters across thresholds or deep-pile carpets.

### 2. Product and Cart Combination

A product and cart combination should be moved with care. Quick stops, excessive force, and uneven surfaces may cause the product and cart combination to overturn.

### 3. Water and Moisture

Do not use this product near water—for example, near a bath tub, wash bowl, kitchen sink or laundry tub, in a wet basement, or near a swimming pool and the like.

### 4. Object and Liquid Entry

Never push objects of any kind into this product through openings as they may touch dangerous voltage points or short-out parts that could result in a fire or electric shock. Never spill liquid of any kind on the product.

### 5. Attachments

Do not use attachments not recommended by the manufacturer of this product as they may cause hazards.

### 6. Cleaning

Unplug this product from the wall outlet before cleaning. Do not use liquid cleaners or aerosol cleaners. Use a damp cloth for cleaning.

### 7. Heat

The product should be situated away from heat sources such as radiators, heat registers, stoves, or other products (including amplifiers) that produce heat.

## SERVICING

### 1. Servicing

If your product is not operating correctly or exhibits a marked change in performance and you are unable to restore normal operation by following the detailed procedure in its operating instructions, do not attempt to service it yourself as opening or removing covers may expose you to dangerous voltage or other hazards. Refer all servicing to qualified service personnel.

### 2. Damage Requiring Service

Unplug this product from the wall outlet and refer servicing to qualified service personnel under the following conditions:

- a. When the power supply cord or plug is damaged.
- b. If liquid has been spilled, or objects have fallen into the product.
- c. If the product has been exposed to rain or water.

PORTABLE CART WARNING  
(Symbol provided by RETAC)



- d. If the product does not operate normally by following the operating instructions. Adjust only those controls that are covered by the operating instructions as an improper adjustment of other controls may result in damage and will often require extensive work by a qualified technician to restore the product to its normal operation.
- e. If the product has been dropped or damaged in any way.
- f. When the product exhibits a distinct change in performance—this indicates a need for service.

### 3. Replacement Parts

When replacement parts are required, be sure the service technician has used replacement parts specified by the manufacturer or which have the same characteristics as the original part. Unauthorized substitutions may result in fire, electric shock or other hazards.

### 4. Safety Check

Upon completion of any service or repairs to this product, ask the service technician to perform safety checks to determine that the product is in safe operating condition.

### How to use the Remote

Before use, insert two AAA size batteries into the Remote with the polarity ( $\oplus$  and  $\ominus$ ) matched correctly as indicated on the battery compartment or on the lid.

- Point the Remote toward the remote sensor on the target component.
- The maximum operating distance of the remote control is about 5 m.

#### NOTE:

*If the Remote does not work properly, remove its batteries, wait for a few seconds, replace the batteries and then try again.*

### Video heads cleaning

Use a dry cleaning cassette – TCL-2— when:

- Rough, poor picture appears while a tape is played back.
- The picture is unclear or no picture appears.

## Buttons, Connectors and Indicators

### Front Panel

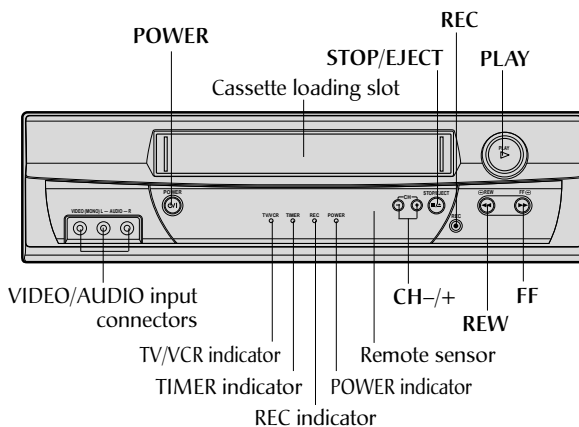

### Rear Panel

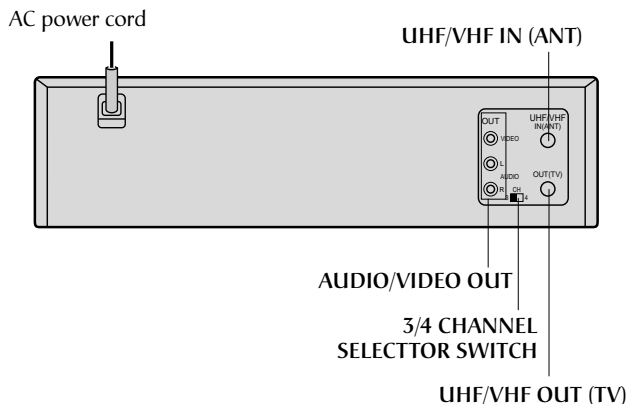

Remote

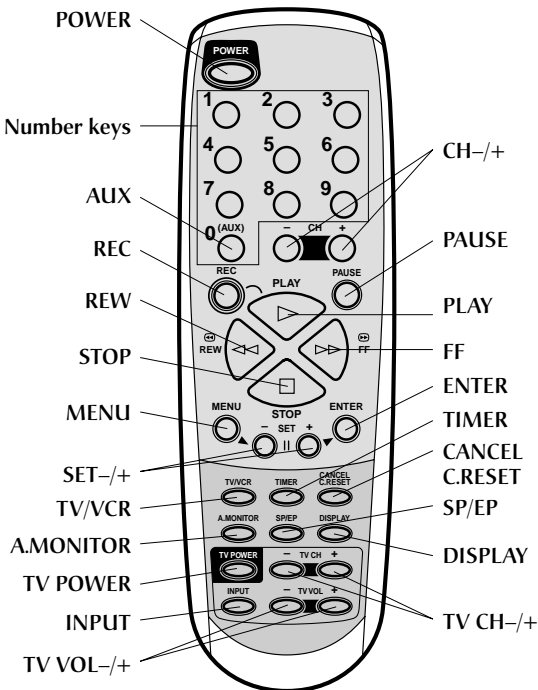

This Remote transmit A code signals only; it is not applicable to B code signals.

On-screen display

If you press DISPLAY on the Remote, you can see the current VCR status on the TV screen. Press DISPLAY again to exit on-screen display. The indications are not recorded even if the VCR is in the recording mode.

WHILE WATCHING TV

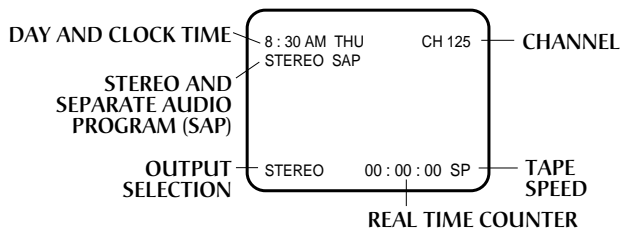

WHILE OPERATING A TAPE

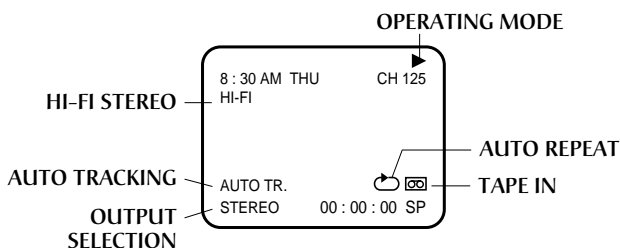

# Connections and VCR channel Setting

## 1 Check contents

Make sure the package contains all of the accessories listed in "Specifications".

## 2 Situate VCR

Place the VCR on a stable, horizontal surface.

## 3 Connect VCR to TV

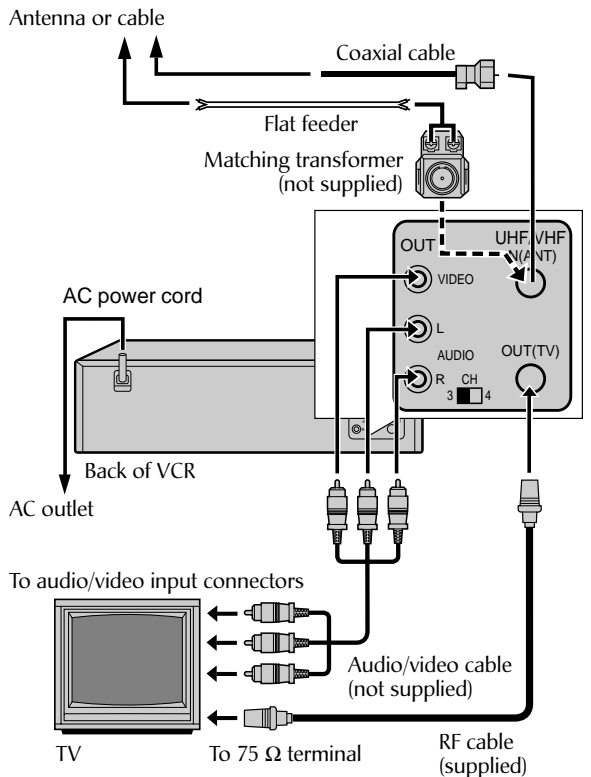

### RF Connection

- 1 Disconnect the TV antenna from the TV.
- 2 Connect the TV antenna cable to the UHF/VHF IN terminal on the rear of the VCR.
- 3 Connect the supplied RF cable between the UHF/VHF OUT terminal on the rear of the VCR and the TV's antenna input terminal.

### AV Connection

(improves picture quality during tape playback.)

If your TV is equipped with audio/video input connectors

- 1 Connect the antenna, VCR and TV as shown in the illustration.
  - 2 Connect an audio/video cable between the AUDIO/VIDEO OUT connectors on the rear of the VCR and the audio/video input connectors on the TV.
- Even if you are using audio/video cables to connect your VCR to your TV, you must also connect it using the RF cable. This will ensure that you can record one show while watching another.

#### 4 Set VCR channel

To view playback of a recorded tape, or to watch a program selected by the VCR's channel selector, the TV must be set to channel 3 or 4 (video channel) when a TV is connected with the 75 ohm coaxial cable only.

- 1 Set the 3/4 Channel selector switch (Rear of the VCR) to CH 3 or 4.
- 2 Turn ON the TV and set to CH 3 or 4 to correspond with the channel selected in 1.
- 3 Press **POWER** to turn on the VCR. The **POWER** indicator will light.
- 4 Press **TV/VCR** to select the VCR position. The **TV/VCR** indicator will light.
- 5 Select any channel to receive a TV station in your area. The channel number will appear on the screen for about 4 seconds.

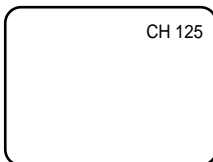

## Initial Settings

### Language Setting

The default setting is "ENGLISH".

#### 1 Access Menu screen

Press **MENU** on the Remote. Press **SET -/+** to select "LANGUAGE", then press **ENTER**.

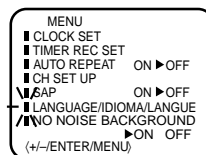

#### 2 Select language

This VCR offers you the language choice to view menus and some messages – in English, Spanish or French. Press **SET -/+** to select your desired language, then press **ENTER**. Press **MENU** twice to return to normal screen.

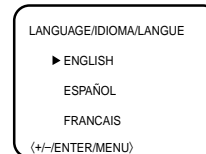

### Clock Setting

#### Preparations

You must set the date and time for timer recording.

#### 1 Access Menu screen

Press **MENU** on the Remote. Press **SET -/+** to select "CLOCK SET", then press **ENTER**.

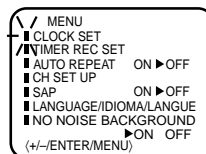

#### 2 Set month, day, year and time

Press **SET -/+** until the desired month appears, then press **ENTER**. Set the day, year and time in the same way.

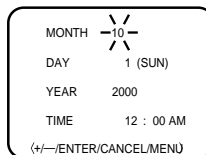

#### 3 Start clock

Press **MENU** twice and normal screen appears.

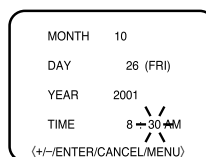

#### To make corrections any time during the process

Press **CANCEL** repeatedly until the item you want to change blinks, then press **SET -/+**.

#### NOTE:

After a power failure or disconnection of the power, the timer settings will be lost. In this case, reset the present time.

## Tuner Setting

This VCR is equipped with a channel memory feature which allows channels to skip up or down to the next channel set into memory, skipping over unwanted channels. Before selecting channels, they must be programmed into the VCR's memory. In addition to normal VHF and UHF channels, this VCR can receive up to 113 Cable TV channels. To use this VCR with an antenna, set the TV/CATV menu option to the TV mode. When shipped from the factory, this menu option is in the CATV mode.

### – TV/CATV Selection

#### 1 Access Menu screen, then CH Set Up screen

Press **MENU** on the Remote. Press **SET -/+** to select "CH SET UP", then press **ENTER**.

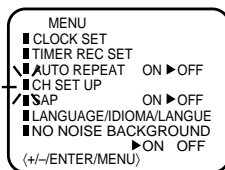

#### 2 Perform TV/CATV Selection

Press **SET -/+** to select "TV/CATV", then press **ENTER** to select the TV or CATV mode. The arrow indicates the selected mode.

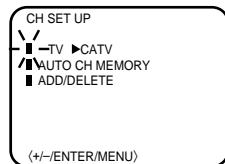

TV - VHF/UHF channels  
CATV - CABLE TV channels

Press **MENU** twice to return to normal screen.

## Setting channels automatically

### – Auto Channel Memory

The VCR can receive a maximum of 181 channels by presetting the channels into memory.

#### 1 Access Menu screen, then CH Set Up screen

Press **MENU** on the Remote. Press **SET -/+** to select "CH SET UP", then press **ENTER**.

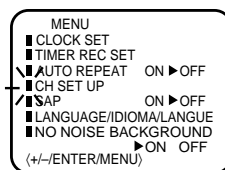

#### 2 Perform Auto Channel Memory

Press **SET -/+** to select "AUTO CH MEMORY", then press **ENTER**.

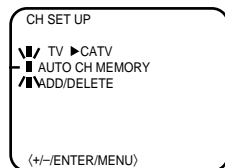

#### 3 Complete Auto Channel Memory

The auto tuning will start. The channel display will count up and when finished, the screen returns to normal.

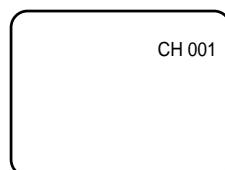

## Setting channels manually

### – Manual Channel Set

You can add the channels you want or delete the channels you do not want manually.

#### 1 Access Menu screen, then CH Set Up screen

Press **MENU** on the Remote. Press **SET -/+** to select "CH SET UP", then press **ENTER**.

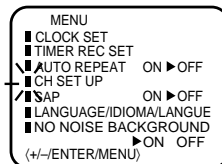

#### 2 Access ADD/DELETE Mode

Press **SET -/+** to select "ADD/DELETE", then press **ENTER**.

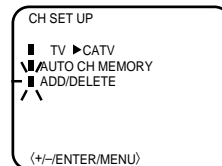

#### 3 Add or Delete desired channels

1 Press **SET -/+** on the Remote to select a channel number you want to add or delete.

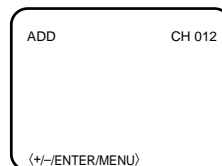

2 To add channels

Press **ENTER** until "ADD" appears on the screen to set to add the unmemorized channel.

To delete channels

Press **ENTER** until "DELETE" appears on the screen to set to delete the channel from memory.

Repeat 1 to 2 to add or delete other channel.

3 Press **MENU** three times three times to return to normal screen.

**NOTE:** You can't select "CH SET UP" if you set the channel to "L".

# Playback

## Basic Playback

### 1 Load a cassette

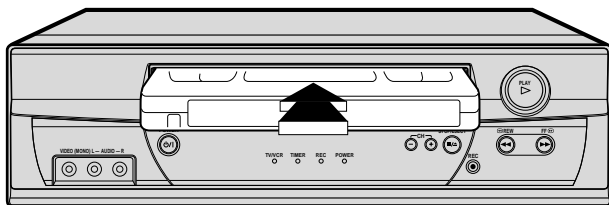

Make sure the window side is up, the rear label side is facing you and the arrow on the front of the cassette is pointing towards the VCR.

- Do not apply too much pressure when inserting.
- The VCR turns on, and the counter on the on-screen display is reset, automatically.
- If the cassette's record safety tab has been removed, playback begins automatically.

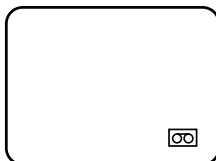

### 2 Start playback

Press **PLAY** (▷) on the Remote.

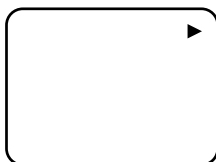

## During playback

### Stop playback

Press **STOP** (□) on the Remote.

OR Press **STOP/EJECT** (■/▲) on the VCR.



### Pause playback and view still picture

Press **PAUSE**.

- Press **PLAY** (▷) to resume normal playback.

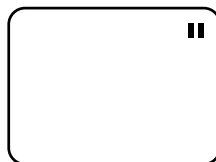

### Pause and Frame-by-Frame playback

Press **PAUSE** to pause, then press **PAUSE** repeatedly. Press **PLAY** (▷) to resume normal playback.

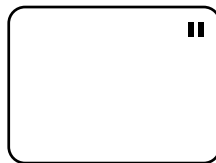

## Slow-motion

Press **PLAY** (▷) on the Remote.

OR Press **Play** (▶) on the VCR.

- Playback will proceed at 1/10 th of the normal speed.
- Press **PLAY** (▷) to resume normal playback.

### NOTE:

During slow motion picture, some noise might appear on the TV screen. Use the **SET-/+** on the Remote to eliminate the noise.

However, the VCR will turn to the default setting once a power failure occurs.

## Speed search

Press **REW** (◀◀) or **FF** (▶▶) on the Remote.

OR Press **REW** (◀◀) or **FF** (▶▶) on the VCR.

- Press **PLAY** (▷) to resume normal playback.

## Variable speed search

Press **REW** (◀◀) or **FF** (▶▶) repeatedly on the Remote.

OR Press **REW** (◀◀) or **FF** (▶▶) repeatedly on the VCR.

- Press **PLAY** (▷) to resume normal playback.
- Each time you press **REW** (◀◀) or **FF** (▶▶) the playback speed changes.

| TAPE SPEED | PICTURE SEARCH SPEED |             |
|------------|----------------------|-------------|
|            | PRESS ONCE           | PRESS TWICE |
| SP         | 3X                   | 5X          |
| EP         | 9X                   | 15X         |

## When the tape is not running

### Rewind/fast-forward

Press **REW** (◀◀) or **FF** (▶▶) on the Remote.

OR Press **REW** (◀◀) or **FF** (▶▶) on the VCR.



### Eject the tape

Press **STOP/EJECT** (■/▲) on the VCR.

- You can also eject the cassette when the VCR is turned off.

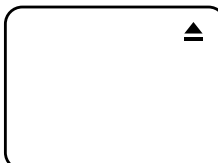

## Turn off the VCR

Press **POWER** on the Remote.

OR Press **POWER** (⏻) on the VCR.

## Playback Features

### Adjusting tracking condition

#### – Tracking Adjustment

##### Automatic tracking adjustment

Whenever you insert a tape and start playback, automatic tracking starts working and continuously analyzes the signal to enable optimum picture quality during playback.

##### Manual tracking adjustment

If automatic tracking cannot eliminate noises well during playback, press **SET**  $-/+$  on the Remote to eliminate the noises. Press it briefly for a fine adjustment, or press and hold for a coarse adjustment.

- Press **SP/EP** on the Remote again to reactivate automatic tracking.

### Playing back tape repeatedly

#### – Auto Repeat Play

##### 1 Access Menu screen

Press **MENU** on the Remote. Press **SET**  $-/+$  to select "AUTO REPEAT".

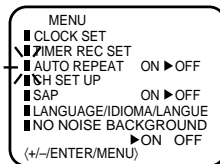

##### 2 Select ON/OFF

Press **ENTER** to select "ON" or "OFF". Press **MENU** to return to normal screen.

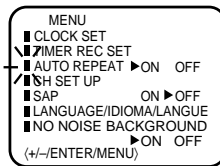

##### 3 Start Auto Repeat Play

Press **PLAY**. The tape will play over and over until the repeat mode is canceled.

## Recording

It may be unlawful to record or play back copyrighted material without the consent of the copyright owner.

### Accidental erasure prevention

To prevent accidental recording on a recorded cassette, remove its record safety tab. To record on it later, cover the hole with adhesive tape.



Record safety tab

### Basic Recording

#### 1 Load a cassette

Make sure the record safety tab is intact. If not, cover the hole with adhesive tape before inserting the cassette.

- The VCR turns on, and the counter is reset, automatically.

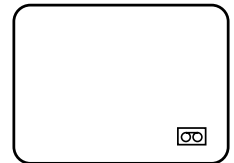

#### 2 Select recording channel

Press **CH**  $-/+$  or the **Number keys** on the Remote [**CH**  $-/+$  on the VCR].

- If you connect the TV and the VCR only using the RF connection, press **TV/VCR** on the Remote so that the TV/VCR indicator lights to view the program to be recorded.

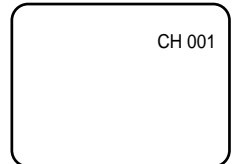

#### 3 Set tape speed

Press **SP/EP**.

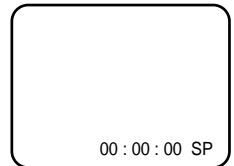

#### 4 Start recording

On the VCR, press **REC**. Or on the Remote, while holding **REC**, press **PLAY** ( $\triangleright$ ).

The REC indicator will light.

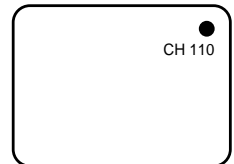

### During recording

#### Pause recording

Press **PAUSE**.

- Press **PAUSE** to resume recording.
- You can select channel in the recording pause mode.



#### Stop recording

Press **STOP** ( $\square$ ) on the Remote.

OR Press **STOP/EJECT** ( $\blacksquare/\blacktriangle$ ) on the VCR.

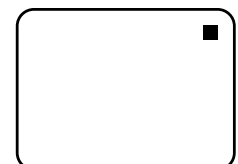



## Recording Features

### Specifying recording length

#### - One Touch Timer Recording (OTR)

The One-touch Timer Recording feature provides a simple and convenient way to make a timed recording.

**EXAMPLE:** One-touch Timer Recording for 30 minutes.

When a TV is connected with an audio/video cable, turn the TV on and select the video input mode on the TV.

- 1 Load a cassette tape with the erase prevention tab intact.

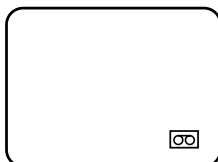

- 2 Press SP/EP to select the desired tape speed SP or EP. The counter and SP or EP will appear on the screen for about 4 seconds.

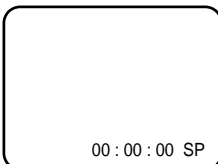

- 3 Press the Number keys or CH +/- to select the channel to be recorded. The channel number will appear on the screen and display for about 4 seconds.

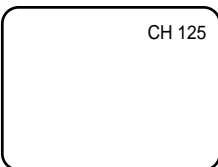

- 4 Press REC on the VCR or while holding REC, press PLAY (▶) on the Remote to begin recording. Press REC on the VCR again to stop recording after 30 minutes. Each additional press of REC will increase recording time as shown in the chart below, up to a maximum of 5 hours. The OTR and recording time will appear on screen for about 4 seconds.

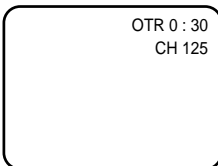

- NOTES:**
- Press REC to increase the time needed for recording (See the chart).
  - To cancel OTR, press STOP (□) or turn off the power.

| Press   | Recording time |
|---------|----------------|
| once    | NORMAL REC     |
| twice   | 0:30           |
| 3 times | 1:00           |
| 4 times | 1:30           |
| 5 times | 2:00           |
| 6 times | 3:00           |
| 7 times | 4:00           |
| 8 times | 5:00           |
| 9 times | NORMAL REC     |

### Watching one program while recording another

During recording...

- If you connect the TV and the VCR only using the RF connection to view pictures from the VCR, press TV/VCR on the Remote so that VCR indicator goes off. (The TV broadcast being recorded disappears.)
- If you are using the AV connection to view pictures from the VCR, change the TV's input mode from AV to TV. Then, select the channel you want to watch, on the TV.

## Timer Recording

Timer recording can be programmed on-screen with the remote control. The built-in timer allows automatic unattended recording of up to 8 programs within 1 month.

### NOTES:

- After timer recording is completed, the VCR turns off automatically.
- You can program the timer recording while a regular recording is in progress; the menu screens will not be recorded.
- The timer recording will start at 20 seconds before the time you predetermined.

**EXAMPLE:** Program a timer recording for the 26th day, channel 125 (CATV), 11:00 - 11:30 PM on timer program number 1 (Tape speed: EP).

When a TV is connected with an audio/video cable, turn the TV and this VCR on and select the video input mode on the TV.

- 1 Press MENU on the Remote. Check the "TIMER REC SET" option is selected, then press ENTER.

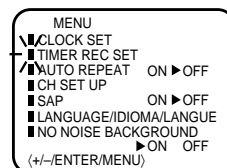

- 2 Press SET +/- to select one of the program lines, then press ENTER.

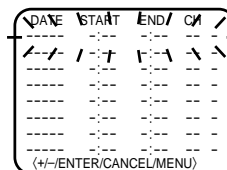

- 3 Press SET +/- to select the date, then press ENTER.

- 4 Set the start time, end time, channel and tape speed as in step 3.

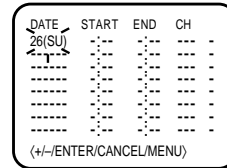

**NOTE:** To record from external source, press SET +/- and set the channel to "L". "L" will appear next to CH 125 (or 69).

- 5 To enter other programs, repeat step 2 through 4. Or, press MENU twice to return to the normal screen.

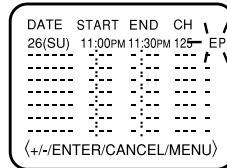

- 6 Press TIMER on the Remote. The power will go off, the TIMER indicator will light and the VCR stands by for recording.

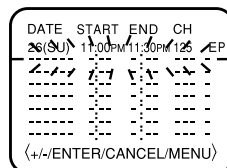

**To use the VCR while it is in timer recording standby mode**  
Press TIMER. After you use the VCR, press TIMER again to put the VCR into timer recording standby mode.

## TO CORRECT THE SETTINGS

When setting the Timer Recording, press **ENTER** until the desired setting blinks, then re-enter the setting using **SET -/+**. When finished, press **ENTER**.

- NOTES:**
- The VCR cannot be used while the **TIMER** indicator is lit.
  - After a power failure or disconnection of the power plug, all programmed recording settings must be reset upon resumption of power. In this case, reset the clock and reprogram any timer recordings.
  - Press **CANCEL** to move cursor backward for correction.

## TO SET DAILY/WEEKLY TIMER

When setting the date in step 3 in the Setting the Timer Recording section on the previous page, press **SET -** repeatedly.

The setting changes as follows:

### Example

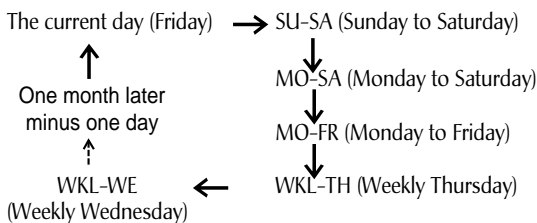

## TO CONFIRM THE SETTINGS

Press **SET -/+** to select the "TIMER REC SET" option in the MENU. Then press **ENTER** to display the timer program list. Press **MENU** twice to return to the normal screen.

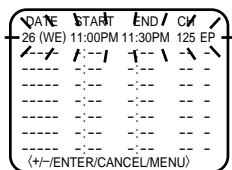

## TO CANCEL A PROGRAM

Press the **SET -/+** to select the "TIMER REC SET" option in the MENU. Then press **SET -/+** to select the unnecessary program, and press **CANCEL** to cancel the program.

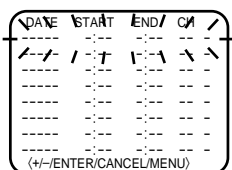

## IF THE PROGRAM OVERLAPS ANOTHER

**NOTE:** Do not overlap programs as portions of the conflicting programs will be lost. The first recording time has priority over the next recording time as shown in the diagram.

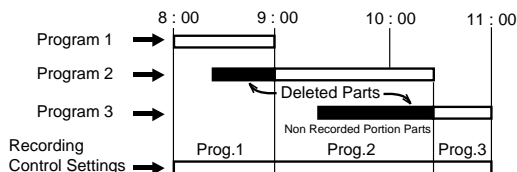

- NOTES:**
- The everyday/every week recording can be made continuously until the recording is canceled or the tape reaches the end.
  - During timer recording, the automatic rewinding mechanism does not function.

## Other Functions

### ■ BLUE BACK – ON/OFF

When this function is set to "ON", the TV screen becomes all blue in the following cases:

- When receiving a channel not in use.
- When stopping playback.

- 1 Press **MENU** on the remote. Press **SET**  $-/+$  to select "NO NOISE BACKGROUND".
- 2 Press **ENTER** to select "ON".
- 3 Press **MENU** to return to normal screen.

### ■ STEREO RECORDING AND PLAYBACK

#### RECORDING STEREO BROADCASTS

The VHS Hi-Fi audio system permits high fidelity recording of MTS STEREO TV broadcasts.

When a MTS STEREO broadcast is received, the STEREO will appear on the screen and the program can be viewed or recorded in stereo.

The Hi-Fi STEREO recording procedure is the same as for normal recordings.

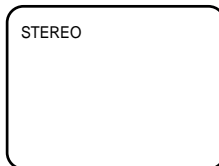

**NOTE:** When using a CATV system, stereo TV programs may be transmitted over a mono cable channel. In this case the word "STEREO" will not appear and the sound will be in mono.

#### OUTPUT SELECTION

When viewing an MTS STEREO TV program, or playing a prerecorded VHS Hi-Fi STEREO videotape, press **A.MONITOR** to select how the audio will be heard through the speakers. Normally set to the Hi-Fi STEREO position, this button can be set to the MONO position if the stereo broadcast or videotape audio is of poor quality. The "R" and "L" positions allow the audio from the Right or Left Hi-Fi channel to be heard over both TV speakers. This button has no effect when viewing a MONO videotape or TV program. Each time when you press the button, OUTPUT SELECTION display appears on the screen for several seconds. Refer to the chart below.

| OUTPUT SELECTION | SOUND HEARD ON BOTH SPEAKERS |
|------------------|------------------------------|
| STEREO           | STEREO                       |
| L ch             | LEFT CHANNEL AUDIO           |
| R ch             | RIGHT CHANNEL AUDIO          |
| MONO             | MONO                         |

- NOTES:**
- When playing back a tape that is not recorded in Hi-Fi stereo mode, the audio will automatically be monaural.
  - When listening to a VHS Hi-Fi video tape or MTS broadcast through the VHF/UHF jack (Audio/Video cord not connected), the sound will be monaural.

### ■ SEPARATE AUDIO PROGRAM (SAP)

Your VCR is fitted with an SAP broadcast system which enables you to switch to a SEPARATE AUDIO PROGRAM when viewing a selected channel.

This function applies only when the program is broadcast in multi-languages through the SAP broadcast system.

When a TV is connected with an audio/video cable, turn the TV and this VCR on, and select the video input mode the TV.

- 1 Press **MENU**. Press on the Remote **SET**  $-/+$  to select "SAP" option.
- 2 Press **ENTER** to select "ON" position.
- 3 Press **MENU** to return to normal screen.

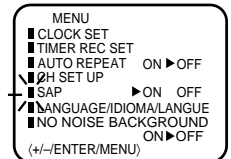
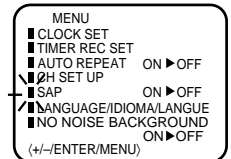

### ■ LISTENING TO SAP

When the VCR is turned on or a channel selection is made, make certain "SAP" appears on the screen.

This means that the "Separate Audio Program" broadcasting is available.

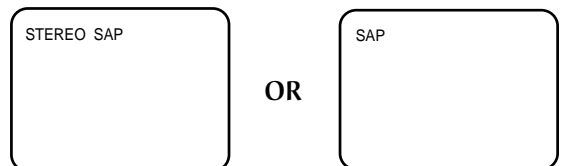

## JVC TV Remote Control

This Remote can control some functions (**TV POWER**, **INPUT**, **TV CH**  $-/+$  and **TV VOL**  $-/+$ ) of a remote controllable JVC TV without setting.

#### NOTE:

- It's not possible to operate a unit not equipped with a remote sensor.
- This Remote can control a JVC TV only.

# Editing

You can use your VCR as the playback or recording VCR. You can use a camcorder as the playback VCR and your VCR as the recording VCR. Refer also to the other components' instruction manuals for connection and its operations.

## 1 Make connections

Example: When using this VCR as the playback VCR

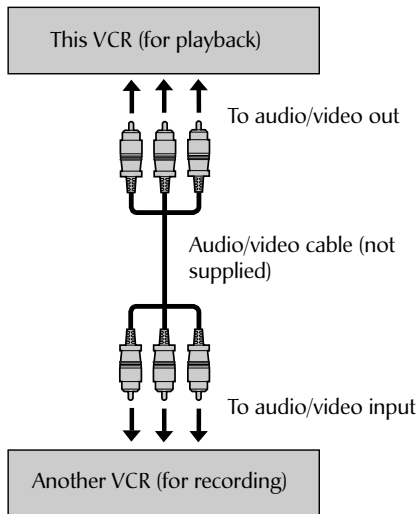

- When using this VCR as the recording VCR, connect this VCR's audio/video input connectors to the audio/video output connectors on the other VCR. If the playback VCR is monaural, connect the audio output connector on the playback VCR to the left audio input connector on this VCR.

## 2 Load cassettes

Insert the playback cassette into the playback VCR and the cassette to be recorded on into the recording VCR.

## 3 Select input mode on recording VCR

Select the correct external input on the recording VCR. On this VCR (when using this VCR as the recording VCR); Select "L" – when connecting the other VCR to the audio/video input connectors on the front panel. Press **O (AUX)** or **CH-/+** on the Remote [**CH-/+** on the VCR].

## 4 Start playback

Press **PLAY** (▶) on the playback VCR.

## 5 Start recording

Press **REC** on the recording VCR.

## Before Requesting Service

Make sure by first checking the following points.

| SYMPTOM   | CAUSE  | POSSIBLE SOLUTION  |
|---|--|--|
| <b>POWER</b>  |  |  |
| No power.   | The AC power cord is not connected.                                      | Connect the AC power cord to the AC outlet.                                      |
| Although the power is on, it does not operate.                          | Cassette is not inserted.  | Insert a video cassette.   |
| <b>TV BROADCAST RECEPTION</b>   |  |  |
| A TV program that is selected by the VCR does not appear on the screen. | Antenna connection is not correct.                                       | Connect it correctly.  |
|   | Antenna cable is disconnected.   | Reconnect the antenna cable.   |
|   | The video channel is not in the correct position.                        | Set it to CH 3 or 4.   |
|   | The TV is not set to the video channel 3 or 4.                           | Set the TV channel selector to the 3 or 4 position.                              |
|   | The TV/VCR selector is set at TV mode (The TV/VCR indicator is not lit). | Press the TV/VCR selector button (The TV/VCR indicator will light).              |
|   | INPUT is set to the LINE mode.   | Press the Number key or CH -/+ button to select your desired TV program.         |
| A TV program selected by the VCR does not appear in color.              | The TV/CATV menu option setting.   | Set the TV/CATV menu option to select TV or CATV mode.                           |
| <b>RECORDING</b>  |  |  |
| TV recording does not work.   | The erase prevention tab of the video cassette is broken off.            | Place a piece of vinyl tape over the gap.  |
|   | INPUT is set to the LINE mode.   | Press the Number key or CH -/+ button to select your desired TV program.         |
| Timer recording does not work.  | The time is not set correctly.   | Reset the present time.  |
|   | The recording start/end time is not set correctly.                       | Set the start/end time.  |
|   | The TIMER button has not been pressed (The TIMER indicator is not lit).  | Press the TIMER button (The TIMER indicator is lit).                             |
| <b>PLAYBACK</b>   |  |  |
| No picture on screen when playing back a recorded tape.                 | The TV is not set to the video channel 3 or 4.                           | Set to the video channel 3 or 4 or adjust the fine tuning button on your TV set. |
| Noise bars on screen.   | Tracking adjustment beyond range of automatic tracking circuit.          | Adjust tracking manually using the SET - or + buttons on the remote control.     |
|   | Video heads are dirty.   | Have the video heads cleaned.  |
|   | The tape is worn or damaged.   | Try another tape.  |
| <b>REMOTE CONTROL</b>   |  |  |
| Remote control does not work.   | It is not aimed at the remote sensor.                                    | Aim it at the remote sensor.   |
|   | Distance too far or too much light in the room.                          | Operate within 15 feet (5 meters) reduce the light in the room.                  |
|   | There is an obstacle in the path of the beam.                            | Clear the path of the beam.  |
|   | The batteries are weak.  | Replace the batteries.   |
|   | The +, - polarity of the batteries are not inserted correctly.           | Insert correctly.  |
| TV programs cannot be seen using the TV selector.                       | The TV/VCR function is in the VCR mode.                                  | Set to TV, or turn off the VCR power button.                                     |

# Specifications

---

## GENERAL

---

|                        |   |  |
|------------------------|---|--|
| Power requirement      | : | AC 120 V, 60 Hz  |
| Power consumption      | : |  |
| Power on               | : | 9 W  |
| Power off              | : | 1.7 W  |
| Temperature            | : |  |
| Operating              | : | 5°C to 40°C (41°F to 104°F)                            |
| Storage                | : | -20°C to 60°C (-4°F to 140°F)                          |
| Operating position     | : | Horizontal only  |
| Dimensions (W x H x D) | : | 360 mm x 95 mm x 224 mm (14-3/16" x 3-3/4" x 8-13/16") |
| Weight                 | : | 3.2 kg (7.1 lbs)                                       |
| Format                 | : | VHS NTSC standard                                      |
| Maximum recording time | : |  |
| SP                     | : | 210 min. with ST-210 video cassette                    |
| EP                     | : | 630 min. with ST-210 video cassette                    |

---

## VIDEO/AUDIO

---

|                           |   |   |
|---------------------------|---|---|
| Signal system             | : | NTSC-type color signal and EIA monochrome signal, 525 lines/60 fields |
| Recording/Playback system | : | DA-4 (Double Azimuth) head helical scan system                        |
| Signal-to-noise ratio     | : | 42 dB   |
| Horizontal resolution     | : | 230 lines   |
| Frequency range           | : |   |
| Normal audio              | : | 100 Hz to 10,000 Hz   |
| Hi-Fi audio               | : | 20 Hz to 20,000 Hz  |
| Input/Output              | : | RCA connectors (IN x 1, OUT x 1)                                      |

---

## TUNER

---

|                  |   |   |
|------------------|---|---|
| Tuning system    | : | Frequency-synthesized tuner   |
| Channel coverage | : |   |
| VHF              | : | Channels 2-13   |
| UHF              | : | Channels 14-69  |
| CATV             | : | 113 Channels  |
| RF output        | : | Channel 3 or 4 (switchable; preset to Channel 3 when shipped) 75 ohms, unbalanced |

---

## TIMER

---

|                         |   |                                       |
|-------------------------|---|---------------------------------------|
| Clock reference         | : | Quartz                                |
| Program capacity        | : | 1-month programmable timer/8 programs |
| Memory backup for timer | : | Approx. 5 sec.                        |

---

## ACCESSORIES

---

|                      |   |  |
|----------------------|---|--|
| Provided accessories | : | RF cable (F-type), Infrared remote control unit, "AAA" battery x 2 |
|----------------------|---|--|

Specifications shown are for SP mode unless specified otherwise.  
E. & O.E. Design and specifications subject to change without notice.

FOR SERVICING (Only in U.S.A.)

## HOW TO LOCATE YOUR JVC SERVICE CENTER

TOLL FREE: 1-800-537-5722

<http://www.jvc.com>

*Dear Customer,*

*In order to receive the most satisfaction from your purchase, please read the instruction booklet before operating the unit. In the event that repair is necessary, or for the address nearest your location within the Continental United States, please call 1-800-537-5722 for your nearest authorized servicer or visit our website at [www.JVC.com](http://www.JVC.com). Remember to retain your Bill of Sale for Warranty Service.*

— JVC

### JVC SERVICE & ENGINEERING COMPANY OF AMERICA

DIVISION OF JVC AMERICAS CORP.

*Sophisticated electronic products may require occasional service. Just as quality is a keyword in the engineering and production of the wide array of JVC products, service is the key to maintaining the high level performance for which JVC is world famous. The JVC service and engineering organization stands behind our products.*

NATIONAL HEADQUARTERS  
JVC SERVICE & ENGINEERING COMPANY OF AMERICA  
DIVISION OF JVC AMERICAS CORP.  
10 New Maple Avenue  
Pine Brook, NJ 07058-9641

### ACCESSORIES

*To purchase accessories for your JVC product, you may contact your local JVC Dealer.*

*From the 48 Continental United States call toll free: 1-800-882-2345 or on the web at [www.JVC.com](http://www.JVC.com)*

*Don't service the product yourself.*

### CAUTION

*To prevent electrical shock, do not open the cabinet. There are no user serviceable parts inside.*

*Please refer to qualified service personnel for repairs.*

# WARRANTY (Only in U.S.A.)

## LIMITED WARRANTY

CONSUMER VIDEO 1-90

JVC COMPANY OF AMERICA warrants this product and all parts thereof, except as set forth below ONLY TO THE ORIGINAL PURCHASER AT RETAIL to be FREE FROM DEFECTIVE MATERIALS AND WORKMANSHIP from the date of original retail purchase for the period as shown below. ("The Warranty Period")

|             |                |
|-------------|----------------|
| PARTS       | LABOR          |
| <b>1 YR</b> | <b>90 DAYS</b> |

THIS LIMITED WARRANTY IS VALID ONLY IN THE FIFTY (50) UNITED STATES, THE DISTRICT OF COLUMBIA AND IN COMMONWEALTH OF PUERTO RICO.

### WHAT WE WILL DO:

If this product is found to be defective, JVC will repair or replace defective parts at no charge to the original owner. Such repair and replacement services shall be rendered by JVC during normal business hours at JVC authorized service centers. Parts used for replacement are warranted only for the remainder of the Warranty Period. All products and parts thereof may be brought to a JVC authorized service center on a carry-in basis except for Television sets having a screen size 25 inches and above which are covered on an in-home basis.

### WHAT YOU MUST DO FOR WARRANTY SERVICE:

Return your product to a JVC authorized service center with a copy of your bill of sale. For your nearest JVC authorized service center, please call toll free: (800) 537-5722.

If service is not available locally, box the product carefully, preferably in the original carton, and ship, insured, with a copy of your bill of sale plus a letter of explanation of the problem to the nearest JVC Factory Service Center, the name and location of which will be given to you by the toll-free number.

If you have any questions concerning your JVC Product, please contact our Customer Relations Department.

### WHAT IS NOT COVERED:

This limited warranty provided by JVC does not cover:

1. Products which have been subject to abuse, accident, alteration, modification, tampering, negligence, misuse, faulty installation, lack of reasonable care, or if repaired or serviced by anyone other than a service facility authorized by JVC to render such service, or if affixed to any attachment not provided with the products, or if the model or serial number has been altered, tampered with, defaced or removed;
2. Initial installation and installation and removal for repair;
3. Operational adjustments covered in the Owner's Manual, normal maintenance, video and audio head cleaning;
4. Damage that occurs in shipment, due to act of God, and cosmetic damage;
5. Signal reception problems and failures due to line power surge;
6. Video Pick-up Tubes/CCD Image Sensor, Cartridge, Stylus (Needle) are covered for 90 days from the date of purchase;
7. Accessories;
8. Batteries (except that Rechargeable Batteries are covered for 90 days from the date of purchase);

There are no other express warranties except as listed above.

THE DURATION OF ANY IMPLIED WARRANTIES INCLUDING THE IMPLIED WARRANTY OF MERCHANTABILITY, IS LIMITED TO THE DURATION OF THE EXPRESS WARRANTY HEREIN.

JVC SHALL NOT BE LIABLE FOR THE LOSS OF USE OF THE PRODUCT, INCONVENIENCE, LOSS OR ANY OTHER DAMAGES, WHETHER DIRECT, INCIDENTAL OR CONSEQUENTIAL (INCLUDING, WITHOUT LIMITATION, DAMAGE TO TAPES, RECORDS OR DISCS) RESULTING FROM THE USE OF THIS PRODUCT, OR ARISING OUT OF ANY BREACH OF THIS WARRANTY. ALL EXPRESS AND IMPLIED WARRANTIES, INCLUDING THE WARRANTIES OF MERCHANTABILITY AND FITNESS FOR PARTICULAR PURPOSE, ARE LIMITED TO THE WARRANTY PERIOD SET FORTH ABOVE.

Some states do not allow the exclusion of incidental or consequential damages or limitations on how long an implied warranty lasts, so these limitations or exclusions may not apply to you. This warranty gives you specific legal rights and you may also have other rights which vary from state to state.

JVC COMPANY OF AMERICA  
DIVISION OF JVC AMERICAS CORP.

1700 Valley Road  
Wayne, New Jersey 07470

REFURBISHED PRODUCTS CARRY A SEPARATE WARRANTY, THIS WARRANTY DOES NOT APPLY. FOR DETAILS OF REFURBISHED PRODUCT WARRANTY, PLEASE REFER TO THE REFURBISHED PRODUCT WARRANTY INFORMATION PACKAGED WITH EACH REFURBISHED PRODUCT.

### For customer use:

Enter below the Model No. and Serial No. which is located either on the rear, bottom or side of the cabinet. Retain this information for future reference.

Model No.: \_\_\_\_\_

Serial No.: \_\_\_\_\_

Purchase date: \_\_\_\_\_

Name of dealer: \_\_\_\_\_



## Free Manuals Download Website

<http://myh66.com>

<http://usermanuals.us>

<http://www.somanuals.com>

<http://www.4manuals.cc>

<http://www.manual-lib.com>

<http://www.404manual.com>

<http://www.luxmanual.com>

<http://aubethermostatmanual.com>

Golf course search by state

<http://golfingnear.com>

Email search by domain

<http://emailbydomain.com>

Auto manuals search

<http://auto.somanuals.com>

TV manuals search

<http://tv.somanuals.com>