

JVC

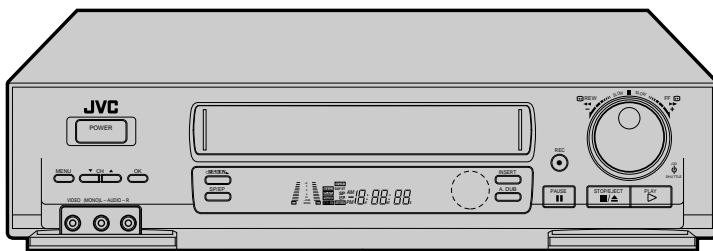

VIDEO CASSETTE RECORDER

HR-DD840U



Hi-Fi **VHS**
TIME SCAN
VCR Plus+
Cable Box Control
Easy Taping.

INSTRUCTIONS

For Customer Use:

Enter below the Model No. and Serial No. which is located on the rear of cabinet. Retain this information for future reference.

Model No. _____



Serial No. _____

LPT0002-015A

Dear Customer,

Thank you for purchasing the JVC VHS video cassette recorder. Before use, please read the safety information and precautions contained in the following pages to ensure safe use of your new VCR.

CAUTIONS

	CAUTION RISK OF ELECTRIC SHOCK DO NOT OPEN	
CAUTION: TO REDUCE THE RISK OF ELECTRIC SHOCK. DO NOT REMOVE COVER (OR BACK). NO USER-SERVICEABLE PARTS INSIDE. REFER SERVICING TO QUALIFIED SERVICE PERSONNEL.		



The lightning flash with arrowhead symbol, within an equilateral triangle, is intended to alert the user to the presence of uninsulated "dangerous voltage" within the product's enclosure that may be of sufficient magnitude to constitute a risk of electric shock to persons.



The exclamation point within an equilateral triangle is intended to alert the user to the presence of important operating and maintenance (servicing) instructions in the literature accompanying the appliance.

WARNING:
TO PREVENT FIRE OR SHOCK HAZARD, DO NOT EXPOSE THIS UNIT TO RAIN OR MOISTURE.

CAUTION:

This video cassette recorder should be used with AC 120V ~, 60Hz only.
To prevent electric shocks and fire hazards, DO NOT use any other power source.

CAUTION:

TO PREVENT ELECTRIC SHOCK, MATCH WIDE BLADE OF PLUG TO WIDE SLOT, FULLY INSERT.

ATTENTION:

POUR ÉVITER LES CHOCS ÉLECTRIQUES, INTRODUIRE LA LAME LA PLUS LARGE DE LA FICHE DANS LA BORNE CORRESPONDANTE DE LA PRISE ET POUSSER JUSQU'AU FOND.

Note to CATV system installer:

This reminder is provided to call the CATV system installer's attention to Article 820-40 of the NEC that provides guidelines for proper grounding and, in particular, specifies that the cable ground shall be connected to the grounding system of the building, as close to the point of cable entry as practical.

CAUTION:

Changes or modifications not approved by JVC could void user's authority to operate the equipment.

Failure to heed the following precautions may result in damage to the VCR, remote control or video cassette.

1. **DO NOT** place the VCR . . .
 - ... in an environment prone to extreme temperatures or humidity.
 - ... in direct sunlight.
 - ... in a dusty environment.
 - ... in an environment where strong magnetic fields are generated.
 - ... on a surface that is unstable or subject to vibration.
2. **DO NOT** block the VCR's ventilation openings.
3. **DO NOT** place heavy objects on the VCR or remote control.
4. **DO NOT** place anything which might spill on top of the VCR or remote control.
5. **AVOID** violent shocks to the VCR during transport.

****MOISTURE CONDENSATION**

Moisture in the air will condense on the VCR when you move it from a cold place to a warm place, or under extremely humid conditions—just as water droplets form on the surface of a glass filled with cold liquid. Moisture condensation on the head drum will cause damage to the tape. In conditions where condensation may occur, keep the VCR's power turned on for a few hours to let the moisture dry before inserting a tape.

****ABOUT HEAD CLEANING**

Accumulation of dirt and other particles on the video heads may cause the playback picture to become blurred or interrupted. Be sure to contact your nearest JVC dealer if such troubles occur.

VCR Plus+C³ and PlusCode are trademarks of Gemstar Development Corporation.

The VCR Plus+ system is manufactured under license from Gemstar Development Corporation.

DSS™ is an official trademark of DIRECTV, Inc., a unit of GM Hughes Electronics. PRIMESTAR is a registered service mark of Primestar Partners, L.P. DISH Network™ is a trademark of EchoStar Communications Corporation.



- Cassettes marked "VHS" (or "S-VHS") can be used with this video cassette recorder. However, only "VHS" recordings can be played back in this model.
- HQ VHS is compatible with existing VHS equipment.

IMPORTANT PRODUCT SAFETY INSTRUCTIONS

Electrical energy can perform many useful functions. But improper use can result in potential electrical shock or fire hazards. This product has been engineered and manufactured to assure your personal safety. In order not to defeat the built-in safeguards, observe the following basic rules for its installation, use and servicing.

ATTENTION:

Follow and obey all warnings and instructions marked on your product and its operating instructions. For your safety, please read all the safety and operating instructions before you operate this product and keep this booklet for future reference.

INSTALLATION

1. Grounding or Polarization

(A) Your product may be equipped with a polarized alternating-current line plug (a plug having one blade wider than the other). This plug will fit into the power outlet only one way. This is a safety feature.

If you are unable to insert the plug fully into the outlet, try reversing the plug. If the plug should still fail to fit, contact your electrician to replace your obsolete outlet. Do not defeat the safety purpose of the polarized plug.

(B) Your product may be equipped with a 3-wire grounding-type plug, a plug having a third (grounding) pin. This plug will only fit into a grounding-type power outlet. This is a safety feature.

If you are unable to insert the plug into the outlet, contact your electrician to replace your obsolete outlet. Do not defeat the safety purpose of the grounding-type plug.

2. Power Sources

Operate your product only from the type of power source indicated on the marking label. If you are not sure of the type of power supply to your home, consult your product dealer or local power company. If your product is intended to operate from battery power, or other sources, refer to the operating instructions.

3. Overloading

Do not overload wall outlets, extension cords, or integral convenience receptacles as this can result in a risk of fire or electric shock.

4. Power Cord Protection

Power supply cords should be routed so that they are not likely to be walked on or pinched by items placed upon or against them, paying particular attention to cords at plugs, convenience receptacles, and the point where they exit from the product.

5. Ventilation

Slots and openings in the cabinet are provided for ventilation. To ensure reliable operation of the product and to protect it from overheating, these openings must not be blocked or covered.

- Do not block the openings by placing the product on a bed, sofa, rug or other similar surface.
- Do not place the product in a built-in installation such as a bookcase or rack unless proper ventilation is provided or the manufacturer's instructions have been adhered to.

6. Wall or Ceiling Mounting

The product should be mounted to a wall or ceiling only as recommended by the manufacturer.

ANTENNA INSTALLATION INSTRUCTIONS

1. Outdoor Antenna Grounding

If an outside antenna or cable system is connected to the product, be sure the antenna or cable system is grounded so as to provide some protection against voltage surges and built-up static charges. Article 810 of the National Electrical Code, ANSI/NFPA 70, provides information with regard to proper grounding of the mast and supporting structure, grounding of the lead-in wire to an antenna discharge unit, size of grounding connectors, location of antenna discharge unit, connection to grounding electrodes, and requirements for the grounding electrode.

2. Lightning

For added protection for this product during a lightning storm, or when it is left unattended and unused for long periods of time, unplug it from the wall outlet and disconnect the antenna or cable system. This will prevent damage to the product due to lightning and power-line surges.

3. Power Lines

An outside antenna system should not be located in the vicinity of overhead power lines or other electric light or power circuits, or where it can fall into such power lines or circuits. When installing an outside antenna system, extreme care should be taken to keep from touching such power lines or circuits as contact with them might be fatal.

EXAMPLE OF ANTENNA GROUNDING AS PER NATIONAL ELECTRICAL CODE, ANSI/NFPA 70

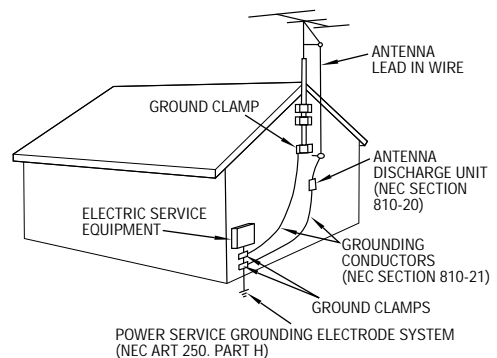

NEC – NATIONAL ELECTRICAL CODE

USE

1. Accessories

To avoid personal injury:

- Do not place this product on an unstable cart, stand, tripod, bracket, or table. It may fall, causing serious injury to a child or adult, and serious damage to the product.
- Use only with a cart, stand, tripod, bracket, or table recommended by the manufacturer or sold with the product.
- Use a mounting accessory recommended by the manufacturer and follow the manufacturer's instructions for any mounting of the product.
- Do not try to roll a cart with small casters across thresholds or deep-pile carpets.

2. Product and Cart Combination

A product and cart combination should be moved with care. Quick stops, excessive force, and uneven surfaces may cause the product and cart combination to overturn.

PORTABLE CART WARNING
(Symbol provided by RETAC)



3. Water and Moisture

Do not use this product near water—for example, near a bath tub, wash bowl, kitchen sink or laundry tub, in a wet basement, or near a swimming pool and the like.

4. Object and Liquid Entry

Never push objects of any kind into this product through openings as they may touch dangerous voltage points or short-out parts that could result in a fire or electric shock. Never spill liquid of any kind on the product.

5. Attachments

Do not use attachments not recommended by the manufacturer of this product as they may cause hazards.

6. Cleaning

Unplug this product from the wall outlet before cleaning. Do not use liquid cleaners or aerosol cleaners. Use a damp cloth for cleaning.

7. Heat

The product should be situated away from heat sources such as radiators, heat registers, stoves, or other products (including amplifiers) that produce heat.

SERVICING

1. Servicing

If your product is not operating correctly or exhibits a marked change in performance and you are unable to restore normal operation by following the detailed procedure in its operating instructions, do not attempt to service it yourself as opening or removing covers may expose you to dangerous voltage or other hazards. Refer all servicing to qualified service personnel.

2. Damage Requiring Service

Unplug this product from the wall outlet and refer servicing to qualified service personnel under the following conditions:

- a. When the power supply cord or plug is damaged.
- b. If liquid has been spilled, or objects have fallen into the product.
- c. If the product has been exposed to rain or water.
- d. If the product does not operate normally by following the operating instructions. Adjust only those controls that are covered by the operating instructions as an improper adjustment of other controls may result in damage and will often require extensive work by a qualified technician to restore the product to its normal operation.
- e. If the product has been dropped or damaged in any way.
- f. When the product exhibits a distinct change in performance—this indicates a need for service.

3. Replacement Parts

When replacement parts are required, be sure the service technician has used replacement parts specified by the manufacturer or have the same characteristics as the original part. Unauthorized substitutions may result in fire, electric shock or other hazards.

4. Safety Check

Upon completion of any service or repairs to this product, ask the service technician to perform safety checks to determine that the product is in safe operating condition.

HOW TO USE THIS INSTRUCTION MANUAL

- All major sections and subsections are listed in the Table Of Contents on page 5. Use this when searching for information on a specific procedure or feature.
- The Index on pages 63–66 lists frequently-used terms, and the number of the page on which they are used or explained in the manual. This section also illustrates the controls and connections on the front and rear panel, the front display panel and the remote control.
- The  mark signals a reference to another page for instructions or related information.
- Operation buttons necessary for the various procedures are clearly indicated through the use of illustrations at the beginning of each major section.

BEFORE YOU INSTALL YOUR NEW VCR . . .

. . . please read the sections/literature listed below.

- "Cautions" on page 2
- "Important Products Safety Instructions" on the previous pages

I	NSTALLING YOUR NEW VCR	6	Recording Features	39
	Basic Connections	6	Record One Program While	
I	NITIAL SETTINGS	7	Watching Another	39
	Plug & Play	7	Display Elapsed Recording Time	39
	Language	8	Stereo And SAP (Second Audio Program)	40
	Clock	9	To Record SAP Programs	40
	Preparation	9	Hi-Fi Audio Recording Level Control	41
	Semi-Auto	10		
	Manual	11		
	Auto	11		
	Tuner	12		
	Set Receivable Channels	12		
	Add Or Delete A Channel	14		
	Cable Box Control	15		
	Situate And Connect Controller	15		
	Set Cable Box Output Channel	16		
	Set Cable Box Brand	17		
	VCR Plus+ Setup	18		
	DBS Receiver Control	20		
	Situate And Connect Controller	20		
	Set DBS Receiver Output Channel	21		
	Set DBS Receiver Brand	22		
S	IMPLE PLAYBACK AND RECORDING	23		
	Simple Playback	23		
	Simple Recording	24		
P	LAYBACK AND RECORDING FEATURES	25		
	Playback Features	25		
	Still Picture/Frame-By-Frame Playback	25		
	Slow Motion/Reverse Slow Motion	25		
	High-Speed Search	25		
	Manual Tracking	26		
	Tape Position Indicator	26		
	Video Stabilizer	27		
	Superimpose	28		
	Select The Soundtrack	29		
	Index Search	30		
	Instant ReView	30		
	Repeat Playback	31		
	Counter Reset	31		
	Counter Memory	31		
	Next-Function Memory	31		
	AV COMPU LINK Playback	32		
	Auto Picture	34		
	Preparation	34		
	Playback	35		
	Time Scan	36		
	Variable-Speed Search/Reverse Motion Playback	36		
	Skip Search	37		
	Time Scan Audio	38		
T	IMER RECORDING	42		
	VCR Plus+ Timer Programming	42		
	On-Screen Timer Programming	44		
	Check And Cancel Programs	46		
	Auto Timer	47		
	Instant Timer Recording (ITR)	48		
E	DITING	49		
	Edit To Or From Another VCR	49		
	Edit From A Camcorder	50		
	Insert Editing	52		
	Audio Dubbing	54		
S	SPECIAL FEATURES	55		
	TV Multi-Brand Remote Control	55		
	Cable Box Multi-Brand Remote Control	56		
	DBS Receiver Multi-Brand Remote Control	57		
	Control Two JVC VCRs	58		
T	ROUBLESHOOTING	59		
	Power	59		
	Tape Transport	59		
	Playback	59		
	Recording	60		
	Timer Recording	60		
	Other Problems	61		
Q	UESTIONS AND ANSWERS	62		
	Playback	62		
	Recording	62		
	Timer Recording	62		
I	NDEX	63		
	List Of Terms	63		
	Front View	64		
	Rear View	65		
	Front Display Panel	65		
	Remote Control	66		
S	PECIFICATIONS	67		
F	OR SERVICING (Only in U.S.A.)	68		
W	ARRANTY (Only in U.S.A.)	69		

Basic Connections

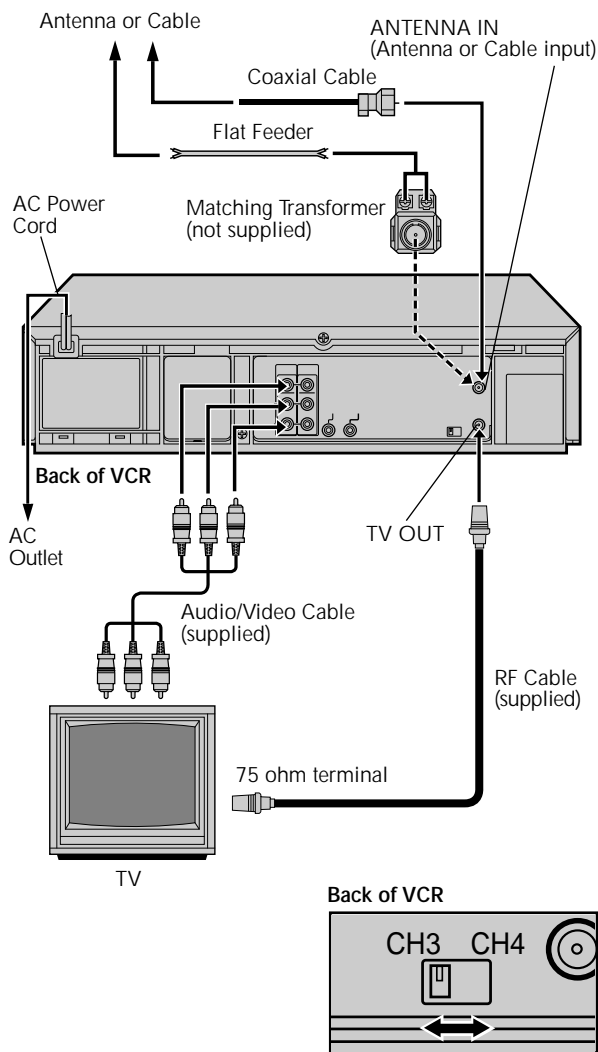

NOTES:

- The VCR channel is the channel on the TV which will display the audio and video signals from the VCR. The VCR's CH3-CH4 switch, on the back of the VCR, sets the VCR channel to CH3 or CH4.
- The CH3-CH4 switch is preset to the CH3 position. Set to CH4 if CH3 is used for broadcasting in your area and set the channel on the TV to correspond to the VCR's CH3-CH4 switch setting.
- If RF connection to TV is used, when switching from VCR to TV mode and from TV to VCR it may be necessary to issue a CH UP and then CH DOWN on TV to obtain a good quality picture.
- Even if you are using AV cables to connect your VCR to your TV, you must also connect it using the RF cable. This will ensure that you can record one show while watching another (☞ pg. 39).
- For full identification of the VCR's rear panel, refer to the Index (REAR VIEW ☞ pg. 65).

1

CHECK CONTENTS

Make sure the package contains all of the accessories listed in "SPECIFICATIONS" (☞ pg. 67).

2

SITUATE VCR

Place the VCR on a stable, horizontal surface.

3

CONNECT VCR TO TV

The connection method you use depends on the type of TV you have.

RF Connection

- To Connect To A TV With NO AV Input Terminals . . .
 - a- Disconnect the TV antenna from the TV.
 - b- Connect the TV antenna cable to the ANTENNA IN jack on the rear of the VCR.
 - c- Connect the supplied RF cable between the TV OUT jack on the rear of the VCR and the TV's antenna terminal. Set TV on CH3 or CH4 corresponding to the CH3 - CH4 switch setting on the back of the VCR.

AV Connection

- To Connect To A TV With AV Input Terminals . . .
 - a- Connect the antenna, VCR and TV as shown in the illustration.
 - b- Connect an Audio/Video Cable between the AUDIO OUT and VIDEO OUT jacks on the rear of the VCR and the AV IN jacks on the TV. Set your TV in video input mode or A/V input mode. Refer to the TV Instruction Manual.

4

CONNECT VCR TO POWER SOURCE

Connect the power plug to an AC outlet.

- The clock and tuner channels will automatically be set when the antenna is connected and when the AC is first connected to the VCR (☞ pg. 7). (If "Auto" or "CH" is displayed on the front display panel before the VCR is powered on, the clock and tuner channels are being set automatically. Wait for the time to be displayed on the front display panel before powering on the VCR.)

5

FINAL PREPARATION FOR USE

Power on the VCR and select the VCR channel (3 or 4) by setting the switch on the rear of the VCR as shown in the illustration. You can now perform simple playback (☞ pg. 23) or simple recording (☞ pg. 24).

Plug & Play

Auto Clock Set/Auto Tuner Set

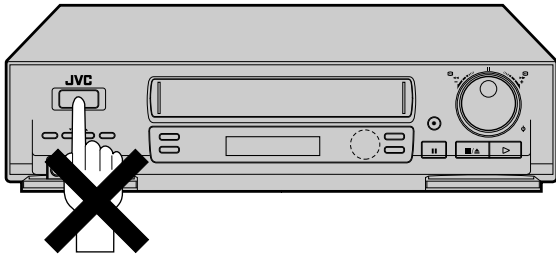

IMPORTANT

- Don't press any buttons on the VCR or remote while Plug & Play is in progress.
- If you perform Plug & Play successfully, there's no need to perform the Clock (pg. 9) and Tuner (pg. 12) procedures. If, however, you want to add or delete channels, refer to "Add Or Delete A Channel" on page 14.

ATTENTION CABLE BOX SUBSCRIBERS

- To perform the Plug & Play procedure . . .
- Connect your cable box to your VCR with the RF cable.
 - Select the PBS channel on your cable box before plugging your VCR's power plug into the AC outlet. (If Plug & Play is not successful you may have to select an alternative PBS channel if another is available in your area.)
 - If there is no PBS channel in your area, or if Plug & Play is not successful, perform the Manual Clock Set procedure (pg. 11).
 - For automatic clock adjustment to take place the VCR's power must be off and the cable box must be set to the PBS channel at clock adjustment times.
 - If you perform Plug & Play successfully, D.S.T. will be set to "AUTO". At the D.S.T. adjustment time (pg. 11), your VCR's power must be off and your cable box must be set to the host PBS channel in your area for the D.S.T. adjustment to take place. If the clock is not set correctly, change the D.S.T. setting to "ON" or "OFF". See step 9 of Semi-Auto procedure (pg. 10) or step 6 of Manual procedure (pg. 11).

NOTE:

If the memory backup fails, because of a power outage or because the AC was removed from the VCR, Plug & Play will be performed when power is restored to the VCR.

The Plug & Play function sets the clock and tuner channels automatically when power is first connected to the VCR. The antenna cable must be connected for the Plug & Play function.

The time and date can be set automatically from clock setting data that is transmitted by one of the regular TV broadcast channels. We call this TV channel the "Host Channel" and it is a PBS channel in your area.

PLUG & PLAY SETUP

1 Connect the antenna cable to the VCR (pg. 6). Then connect the VCR's power plug to an AC outlet. Do not power on the VCR. The clock and tuner channels will be set automatically.

NOTES:

- Auto clock set is performed first. The auto clock set function scans all the channels received by your VCR to find the Host Channel and then sets the clock. "Auto" blinks on the front display panel during Auto clock set.
- Auto channel set is performed next. The auto channel set function scans all the channels that are receivable by your VCR. It then automatically assigns each receivable channels to the CH▲▼ buttons. It skips non-receivable channels. During auto channel set the channel numbers are displayed as they are scanned and set.
- When Plug & Play has been completed successfully the correct time is displayed.
- If "AUTO CLOCK SET" or "SEMI-AUTO CLOCK SET" is selected at the Override Auto Clock Set screen on page 10, the clock will be adjusted automatically by the host channel every hour on the hour (except for 11:00 PM, midnight, 1:00 AM and 2:00 AM) by the incoming PBS channel clock setting data. (This automatic clock adjustment can only be performed when the VCR's power is turned off. The clock will be adjusted on the hour based on the time displayed on the VCR, not on the actual real time.) The default setting is "AUTO CLOCK SET".
- If an incorrect time is displayed on the front display panel, you may be receiving the clock setting data of a PBS channel from an adjacent time zone, or an incorrect PBS channel from a cable TV system. In this case, perform the Semi-Auto (pg. 10) or Manual Clock Set (pg. 11) procedure. Auto channel set has already taken place and it need not be set again.
- If " - - - " appears on the display, your antenna cable may not be connected to the VCR, there may not be a Host PBS signal available in your area, or your cable box may not be set to the PBS channel. Ensure that the antenna cable is connected correctly. If you use a cable box ensure that your local PBS channel is selected on your cable box (ATTENTION CABLE BOX SUBSCRIBERS). Then power on and power off the VCR; the Plug & Play function will be automatically reactivated and "Auto" will be displayed on the VCR's front panel. If Plug & Play is not performed but everything is connected and set correctly, perform the Manual Clock Set procedure (pg. 11). Auto channel set has not yet taken place, so please also perform the "Set Receivable Channels" procedure (pg. 12).

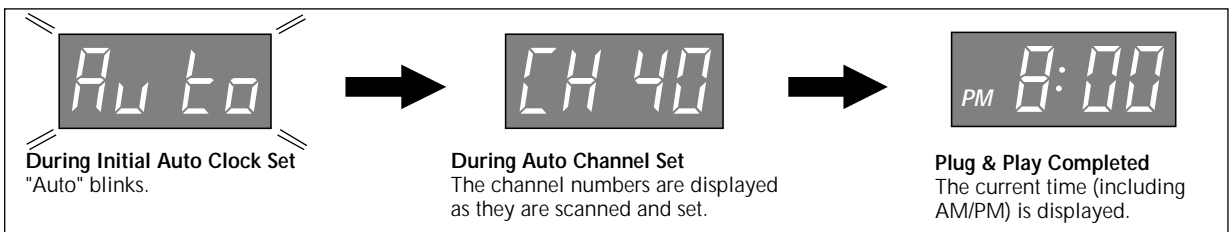

Language

Turn on the TV and select the VCR channel 3 or 4 (or AV mode).

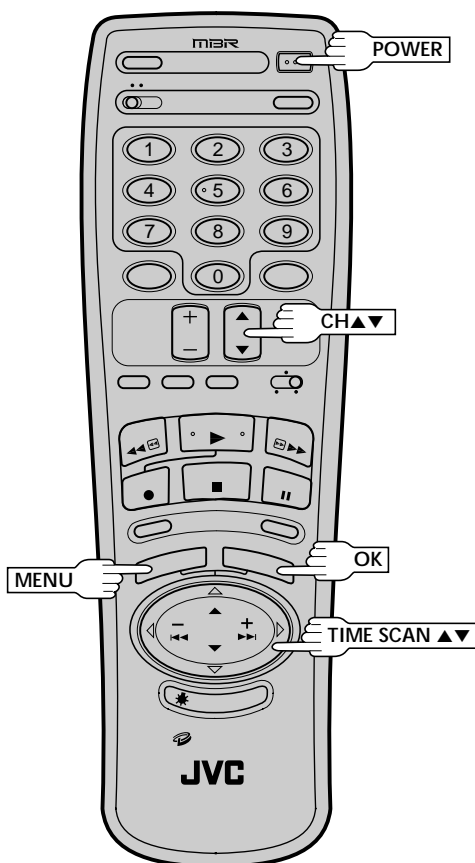
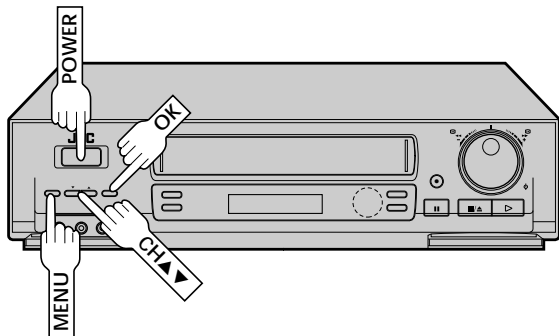

This VCR offers you the choice to view on-screen messages in English, Spanish or French (not including messages superimposed on the TV picture). Select the desired language using this procedure. The default setting is "ENGLISH".

1 TURN ON THE VCR

Press **POWER**.

2 ACCESS ON-SCREEN MENU

Press **MENU** as many times as necessary.

3 ACCESS CUSTOM SET SCREEN

At the Main Menu screen, move the highlight bar (arrow) to "CUSTOM SET" by pressing **CH▲▼** or **TIME SCAN▲▼**, then press **OK**.

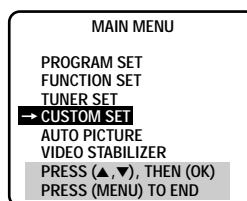

4 ACCESS LANGUAGE SELECT SCREEN

The messages are preset to appear in English. If you want to see them in Spanish or French, move the highlight bar (arrow) to "LANGUAGE SELECT" by pressing **CH▲▼** or **TIME SCAN▲▼**, then press **OK**.



5 SELECT LANGUAGE

At the Language Select screen, move the highlight bar (arrow) to the desired language by pressing **CH▲▼** or **TIME SCAN▲▼**, then press **MENU** as many times as necessary to return to the normal screen.



Clock

Turn on the TV and select the VCR channel 3 or 4 (or AV mode).

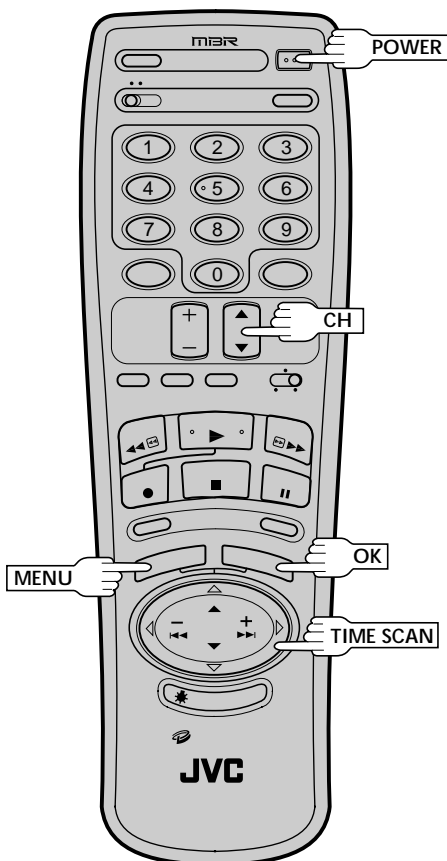
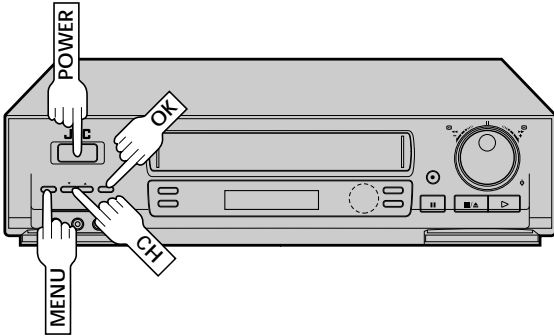

Perform clock setting only if the clock has not been set correctly by the Plug & Play function. Access the Override Auto Clock Set screen to choose the Auto, Semi-Auto or Manual clock setting procedure. Each procedure starts from step 5. *Auto need only be selected if Semi-Auto or Manual had previously been selected.

Preparation

1 TURN ON THE VCR

Press **POWER**.

2 ACCESS ON-SCREEN MENU

Press **MENU** as many times as necessary.

3 ACCESS CUSTOM SET SCREEN

At the Main Menu screen, move the highlight bar (arrow) to "CUSTOM SET" by pressing **CH▲▼** or **TIME SCAN▲▼**, then press **OK**.

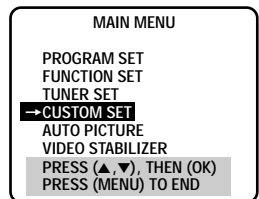

4 ACCESS CLOCK SET MODE SELECT SCREEN

Move the highlight bar (arrow) at the Custom Set screen to "OVERRIDE AUTO CLOCK SET" by pressing **CH▲▼** or **TIME SCAN▲▼**, then press **OK**.

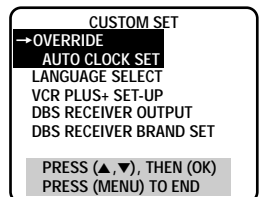

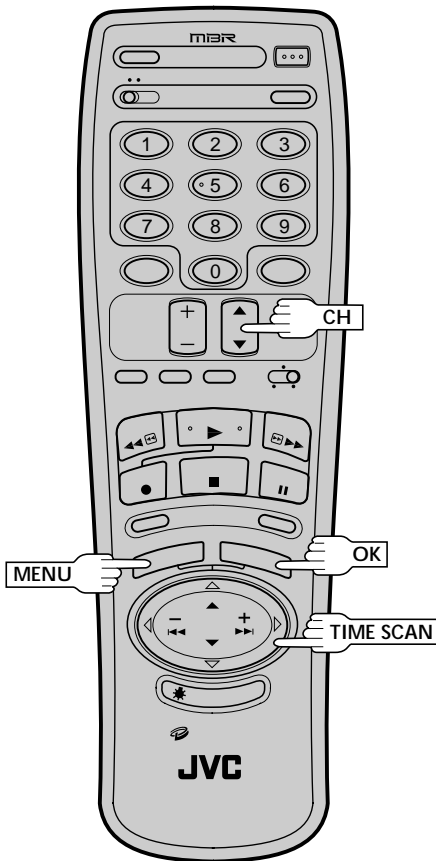
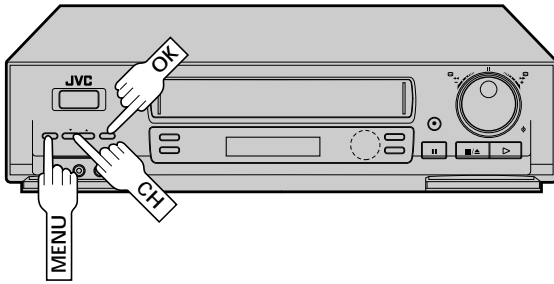

Semi-Auto

5

SELECT MODE

At the Override Auto Clock Set screen, move the highlight bar (arrow) to "SEMI-AUTO CLOCK SET" by pressing **CH▲▼** or **TIME SCAN▲▼**, then press **OK**.

OVERVERRIDE AUTO CLOCK SET

AUTO CLOCK SET
 → SEMI-AUTO CLOCK SET
 MANUAL CLOCK SET

PRESS (▲, ▼), THEN (OK)
 PRESS (MENU) TO END

6

ACCESS SELECT SCREENS

At the Semi-Auto Clock Set screen, move the highlight bar (arrow) to the desired mode by pressing **CH▲▼** or **TIME SCAN▲▼**, then press **OK**.

SEMI-AUTO CLOCK SET

→ HOST CHANNEL SELECT
 TIME ZONE SELECT
 D.S.T. SELECT

PRESS (▲, ▼), THEN (OK)
 PRESS (MENU) TO END

To select the Host Channel — step 7

To select the Time Zone — step 8

To select the D.S.T. mode — step 9

NOTE:

The time that has been set previously by the Plug & Play function will be erased when any of the three settings mentioned above is changed.

7

SELECT HOST CHANNEL

You can either select "AUTO", or enter a PBS channel number. For automatic selection, press **MENU** if "AUTO" is highlighted on the Host Channel Select screen. To manually select "AUTO" or the PBS channel, press

CH▲▼ or **TIME SCAN▲▼** to cycle through "AUTO" or the channel numbers (hold button down to speed through numbers) and stop when the desired number appears. Press **MENU** and the Semi-Auto Clock Set screen reappears.

HOST CHANNEL SELECT

(CATV)
 CH AUTO

PRESS (▲, ▼) TO SELECT
 PRESS (MENU) TO END

NOTES:

- For cable box users: Select "AUTO" or the channel on your VCR that receives the cable box channels, and set the cable box to the PBS channel.
- There are some PBS channels that do not transmit clock setting data.

Manual

8

SELECT TIME ZONE

You can select the zone automatically or manually by pressing **CH▲▼** or **TIME SCAN▲▼**. If an incorrect time is displayed you may be receiving the clock setting data of a PBS channel from an adjacent time zone or from an incorrect PBS channel from a cable TV system. If you selected "AUTO" in step 7 select "MANUAL" and select the correct time zone manually.

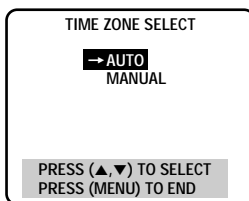

- If you selected "AUTO", press **MENU** to return to the Semi-Auto Clock Set screen.
- If you selected "MANUAL", press **OK** and the screen to the right appears. Move the highlight bar (arrow) to your choice by pressing **CH▲▼** or **TIME SCAN▲▼**, then press **MENU** twice to return to the Semi-Auto Clock Set screen.

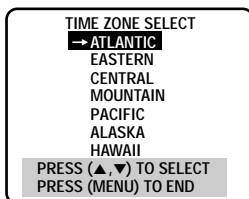

9

SELECT D.S.T. MODE

You have three choices:
a–Select "AUTO" and the adjustment to your VCR's clock will be made according to the incoming signal from the host channel.

b–Select "ON" and the adjustment will be made based on the clock itself.

c–Select "OFF" if Daylight Saving Time doesn't apply to you.

Move the highlight bar (arrow) to your choice by pressing **CH▲▼** or **TIME SCAN▲▼**, then press **MENU** and the Semi-Auto Clock Set screen reappears.

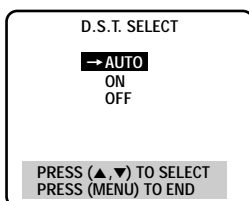

IMPORTANT

Turn the VCR off after performing the Semi-Auto Clock Set procedure. "Auto" will appear on the front display panel when the clock is being set. The current time will appear automatically when the clock is set.

5

SELECT MODE

At the Override Auto Clock Set screen (pg. 10), move the highlight bar (arrow) to "MANUAL CLOCK SET" by pressing **CH▲▼** or **TIME SCAN▲▼**, then press **OK**.

6

SET DATE, TIME AND D.S.T.

The Manual Clock Set screen is displayed and the month digit begins blinking. Press the appropriate **NUMBER** keys to set the date and time (if only 1 digit, press "0" first). Press **CH▲▼** or **TIME SCAN▲▼** to set AM/PM and D.S.T. (Daylight Saving Time). Press **OK** after AM/PM and D.S.T. settings. Set D.S.T. to "ON" to set the D.S.T. according to the VCR's clock or to "OFF" if D.S.T. doesn't apply to you. When you're finished with this set-up procedure, press **MENU** to start the clock.

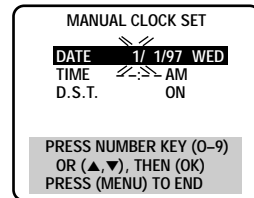

NOTES:

- **CH▲▼** and **TIME SCAN▲▼** can be used to perform all operations. (In this case, press **OK** after each setting.)
- At the Manual Clock Set screen, the setting that can be set blinks. When setting of a highlighted item is completed, the highlight bar moves down by 1 line to the next item.

7

MAKE CORRECTIONS

To change any of the settings, press **OK** or **TIME SCAN** <▷> until the item you want to change blinks, then set as in step 6.

Auto

5

SELECT MODE

At the Override Auto Clock Set screen, move the highlight bar (arrow) to "AUTO CLOCK SET" by pressing **CH▲▼** or **TIME SCAN▲▼**, then power off the VCR. Do not power it on again until the clock has been adjusted. After the clock is set it will be automatically adjusted on the hour except at 11:00 PM, midnight, 1:00 AM and 2:00 AM. (The clock will be adjusted on the hour based on the time displayed on the VCR, not on the actual real time.)

**AUTO DAYLIGHT SAVING TIME

This function enables automatic adjustment of the VCR's clock at the start and end of Daylight Saving Time.

With Auto DST activated, . . .

. . . on the first Sunday of April at 2:00 AM, the clock is adjusted to 3:00 AM.

. . . on the last Sunday of October at 2:00 AM, the clock is adjusted to 1:00 AM.

Tuner

Turn on the TV and select the VCR channel 3 or 4 (or AV mode).

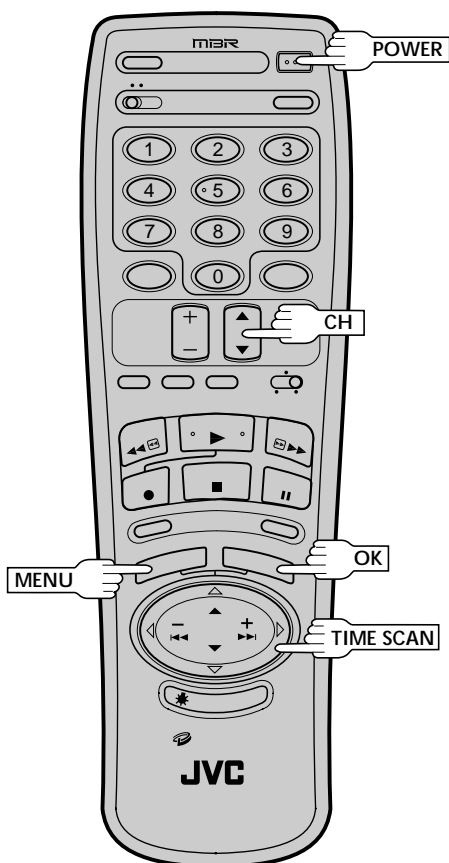
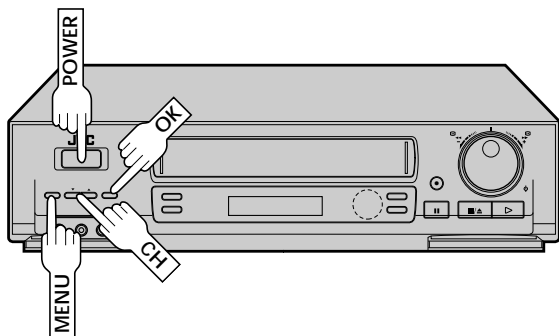

Set Receivable Channels

1 TURN ON THE VCR

Press **POWER**.

2 ACCESS MAIN MENU SCREEN

Press **MENU** as many times as necessary.

3 ACCESS TUNER SET SCREEN

Move the highlight bar (arrow) to "TUNER SET" by pressing **CH▲▼** or **TIME SCAN▲▼**, then press **OK**.

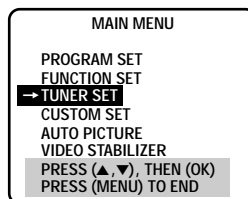

4 PERFORM AUTO CHANNEL SET

Move the highlight bar (arrow) to "AUTO CHANNEL SET" by pressing **CH▲▼** or **TIME SCAN▲▼**, then press **OK**.

- Receivable channels in your area are automatically assigned to the **CH▲▼** buttons, and non-receivable channels are skipped.

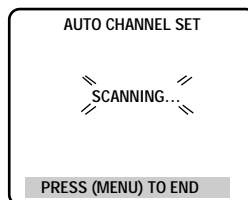
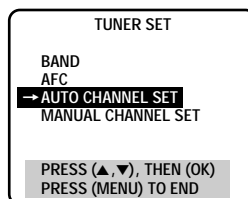

NOTES:

- At the end of Auto Channel Set, "SCAN COMPLETED" appears on screen.
- If the scan was unsuccessful, "SCAN COMPLETED-NO SIGNAL" appears on screen. Check the connections and start again.

5 RETURN TO NORMAL SCREEN

Press **MENU** as many times as necessary.

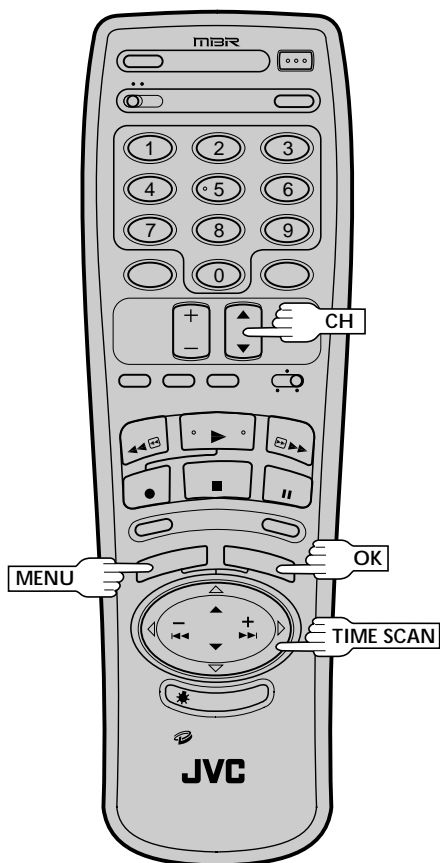
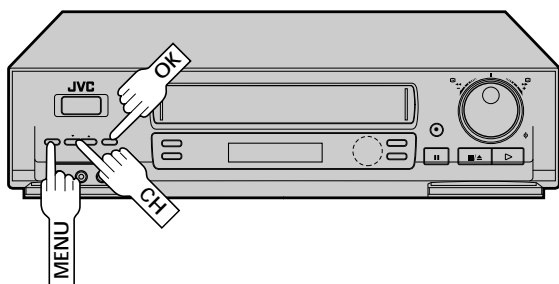

INFORMATION

The VCR detects the band (TV or CATV) and selects the correct band automatically during Auto Channel Set. If necessary, you can check the setting at the Band screen after Auto Channel Set has set the channels.

- At the Tuner Set screen, move the highlight bar (arrow) to "BAND" by pressing **CH▲▼** or **TIME SCAN▲▼**, then press **OK**.

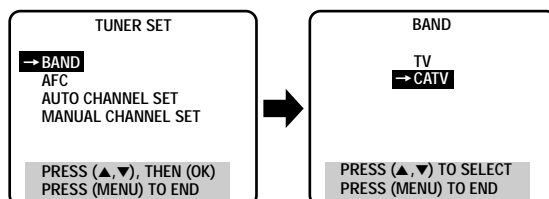

- Press **MENU** as many times as necessary to return to the normal screen.

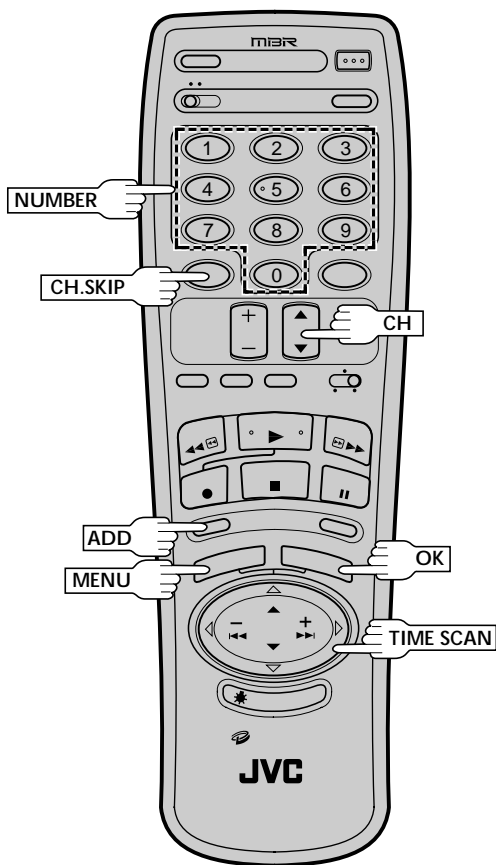
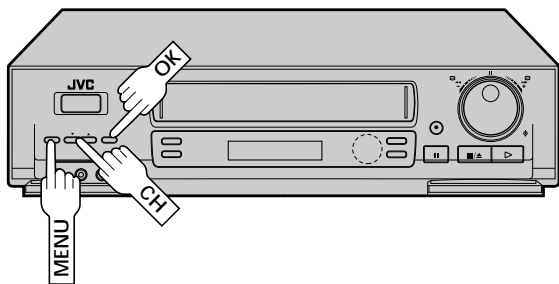

Add Or Delete A Channel

1

ACCESS TUNER SET SCREEN

Access by performing steps 2 and 3 of the Tuner procedure on page 12.

- To add a channel, go to step 2.
- To delete a channel, skip to step 4.

2

ACCESS AFC SCREEN

Move the highlight bar (arrow) to "AFC" by pressing CH▲▼ or TIME SCAN▲▼, then press OK.

3

MAKE SELECTION

Move the highlight bar (arrow) to "SPCL" by pressing CH▲▼ or TIME SCAN▲▼, then press MENU to return to the Tuner Set screen.

- AFC set to SPCL (special) is necessary for tuning on certain CATV systems.

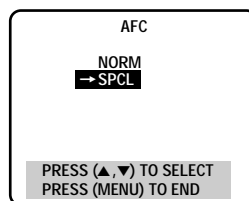

4

ACCESS MANUAL CHANNEL SET SCREEN

Move the highlight bar (arrow) to "MANUAL CHANNEL SET" by pressing CH▲▼ or TIME SCAN▲▼, then press OK.

5

STORE OR SKIP DESIRED CHANNEL

Input the channel number using the NUMBER keys or by pressing CH▲▼ or TIME SCAN▲▼, then press ADD to add or CH.SKIP to delete. Repeat for each channel you want to store or skip.

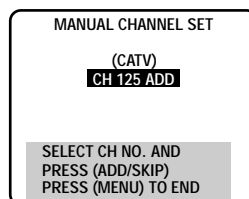

6

RETURN TO NORMAL SCREEN

Press MENU as many times as necessary.

Cable Box Control

Suggested Location

Place the cable box on top of the VCR. Attach the VCR's Controller to the top of the VCR with the Controller's transmitter pointed towards the cable box's remote sensor.

Attention:

The Controller can also control a DBS receiver. If both a cable box and a DBS receiver are used, position the controller so its signal reaches the remote control sensors of both the cable box and DBS receiver.

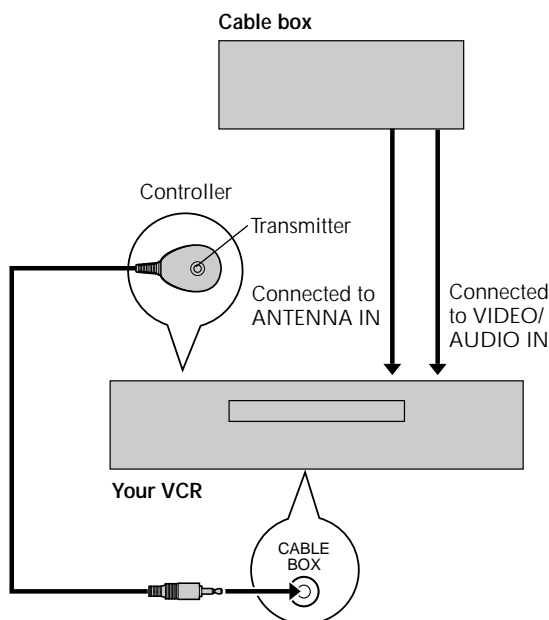
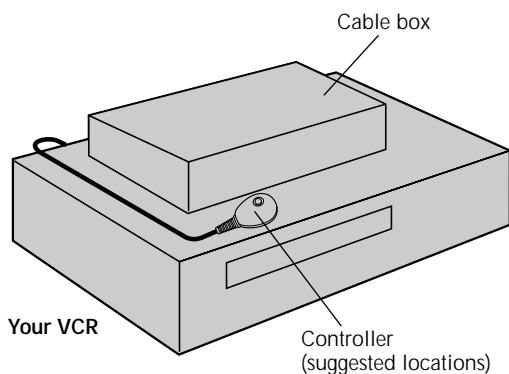

This procedure is required if you receive your TV channels through a cable box (descrambler). The Controller allows the VCR to automatically switch the cable box channel during timer-recording. The Controller is effective for recording shows that have been programmed using VCR Plus+ (☞ pg. 42) or On-Screen Timer Programming (☞ pg. 44).

Situate And Connect Controller

1 SITUATE CONTROLLER

Place the Controller so that the path between its transmitter and the cable box's remote sensor is unobstructed.

2 ATTACH CONTROLLER

Fasten securely using the supplied adhesive strip.

3 CONNECT CABLE BOX TO VCR

The connection method depends on the type of cable box you have.

If your cable box has AUDIO and VIDEO OUT connectors . . .

. . . connect them to the AUDIO and VIDEO IN connectors on your VCR; select the correct external input mode as described in step 4, 5, 9 – 11 on page 50 & 51. Set the VCR to channel "AU" to use the cable box.

If your cable box doesn't have AUDIO and VIDEO OUT connectors . . .

. . . connect the antenna output connector on the cable box to the ANTENNA IN connector on the rear of your VCR.

Set the VCR tuner to the same channel as the cable box RF output (see page 16 also).

NOTE:

When connecting your cable box refer to its instruction manual.

4 CONNECT CONTROLLER TO VCR

Connect to the CABLE BOX connector on your VCR.

About Your Cable Box

This VCR has two separate methods to control your Cable Box.

- *The VCR's Wireless Remote Control Unit can control your Cable Box. This eliminates the need for a separate Cable Box Remote Control Unit.*
- *The VCR's Controller can also control your Cable Box. This allows the VCR to change your Cable Box's channel number during timer recording.*

Each method must be set up separately. To set up the VCR's Remote Control unit, refer to page 56. To set up the Controller go to page 16.

Turn on the TV and select the VCR channel 3 or 4 (or AV mode).

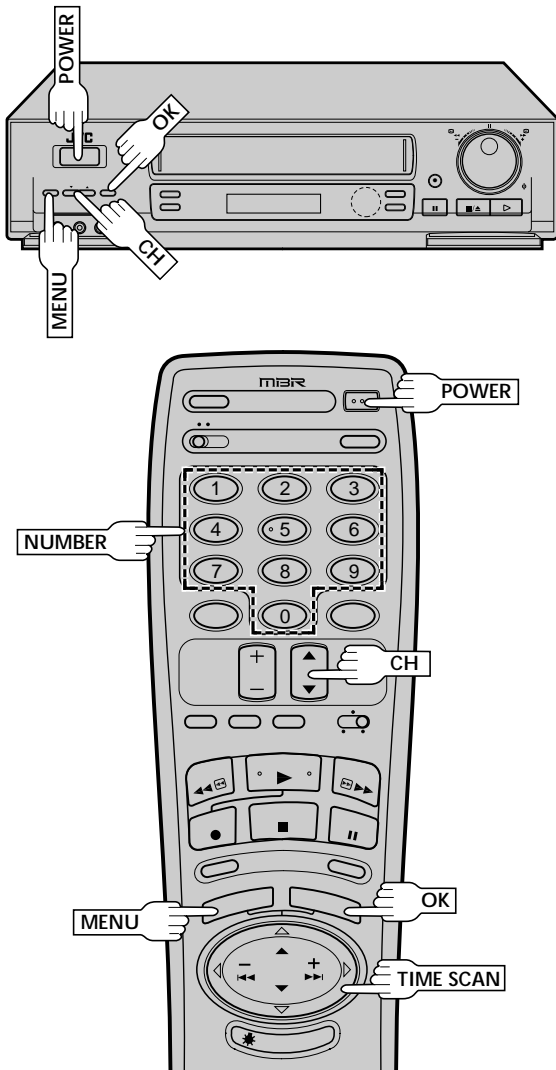

Set Cable Box Output Channel

- 1** **TURN ON THE VCR**
Press **POWER**.
- 2** **ACCESS MAIN MENU SCREEN**
Press **MENU** as many times as necessary.

3

ACCESS CUSTOM SET SCREEN

Press **CH▲▼** or **TIME SCAN▲▼** to move the highlight bar (arrow) to "CUSTOM SET", then press **OK**.

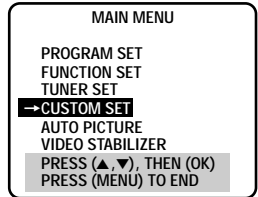

4

ACCESS VCR PLUS+ SET-UP SCREEN

Press **CH▲▼** or **TIME SCAN▲▼** to move the highlight bar (arrow) to "VCR PLUS+ SET-UP", then press **OK**.

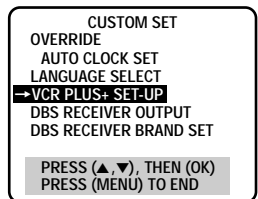

5

ACCESS CABLE BOX OUTPUT SCREEN

Press **CH▲▼** or **TIME SCAN▲▼** to move the highlight bar (arrow) to "CABLE BOX OUTPUT", then press **OK**.

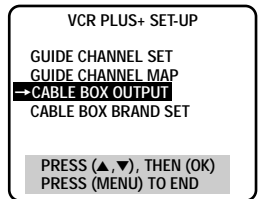

6

SELECT CABLE BOX OUTPUT CHANNEL

Your selection depends on how your cable box is connected to your VCR.

If your cable box is connected to your VCR using an RF connection . . .

. . . press **CH▲▼** or **TIME SCAN▲▼** to move the highlight bar (arrow) to the channel number representing the cable box's output (2-6).

If your cable box is connected to your VCR's AUDIO/VIDEO IN connectors . . .

. . . press **CH▲▼** or **TIME SCAN▲▼** to move the highlight bar (arrow) to "ON LINE".

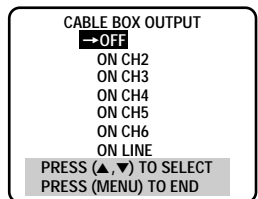

7

RETURN TO VCR PLUS+ SET-UP SCREEN

Press **MENU**.

Set Cable Box Brand

1 TURN ON CABLE BOX
Select a channel other than channel 9 on your Cable Box.

2 ACCESS CABLE BOX BRAND SET SCREEN

At the VCR Plus+ Set-Up screen, press **CH▲▼** or **TIME SCAN▲▼** to move the highlight bar (arrow) to "CABLE BOX BRAND SET", then press **OK**.

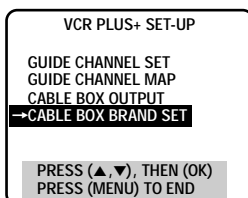

3 ENTER CABLE BOX BRAND

Press the appropriate **NUMBER** keys to enter the Cable Box Code from the CABLE BOX BRAND LIST to the right, then press **OK**.

- If the cable box's channel changes to 9, setting is complete.
- If there are more than one code number listed for your brand of cable box, repeat step 3 until the cable box's channel changes to 9.
- If the channel does not change after going through all the code numbers listed for your model of cable box, then try all the other numbers between 1 and 69.

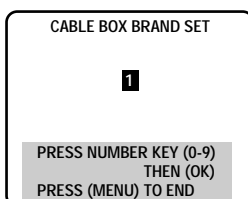

4 RETURN TO NORMAL SCREEN

Press **MENU** as many times as necessary.

You can now set up the VCR Plus+ feature (pg. 18).

NOTES:

- Although the supplied Controller is compatible with many different cable box brands, it is possible that it will not work with your cable box.
- If your cable box doesn't respond to any code between 1 and 69, you can't use the Controller to change cable box channels. In this case, make sure to leave the cable box turned on and tuned to the proper channel before the scheduled start of timer recording. Please contact your cable company about the possibility of exchanging your current cable box with one that is compatible with your VCR.
- The VCR can only change the cable box channel through the Controller during timer recording.
- If your cable box is one that can't be operated with a remote control (because it has no remote sensor), you can't use the Controller to change its channels. Make sure to leave the cable box turned on and tuned to the proper channel before the scheduled start of timer recording.
- **For customers in U.S.A.:** If you are unable to set the Controller, please contact JVC toll free at 1-800-252-5722.

CABLE BOX BRAND LIST

BRAND	CODE
ARCHER	49, 52, 53, 54
CABLEVIEW	49, 53
CITIZEN	49, 53
CURTIS	9, 10, 62, 63
DIAMOND	52, 53, 54
EAGLE	30, 31, 32, 33, 34, 35, 36, 37
EASTERN	51
GC BRAND	49, 53
GEMINI	8, 56
GENERAL ELECTRIC	67
GENERAL INSTRUMENTS	1, 2, 3, 4, 5, 6, 7, 8
HAMLIN	15, 16, 17, 18
JERROLD	1, 2, 3, 4, 5, 6, 7, 8
MACOM, HITACHI	57, 58, 59
MAGNAVOX	30, 31, 32, 33, 34, 35, 43
MOVIE TIME	44, 45, 46
NSC	44, 45, 46
OAK	19, 20, 21, 30, 47, 48
PANASONIC	24, 25, 26
PHILIPS	30, 31, 32, 33, 42
PIONEER	13, 14
PULSER	49, 53
RCA	24, 25, 26
REGAL	15, 16, 17, 18, 33
REGENCY	51
SAMSUNG	8, 13, 49, 50
SCIENTIFIC ATLANTA	9, 10, 62, 63
SIGMA	19, 20, 21
SL MARX	8, 13, 49, 50
SPRUCER	24, 25, 26
STARGATE	8, 13, 49, 50
SYLVANIA	29
TEKNIKA	68, 69
TELECAPTION	27
TELEVIEW	8, 13, 49, 50
TEXSCAN	28, 29
TOCOM	22, 23, 64, 65, 66
UNIKA	52, 53, 54
UNIVERSAL	38, 39, 40, 41
VIDEOWAY	11, 12, 60, 61
VIDEO TECH	55
VIDTER	55
VIEWSTAR	30, 31, 32, 33, 34, 35, 36, 37
ZENITH	11, 12, 60, 61

VCR Plus+ Setup

Turn on the TV and select the VCR channel 3 or 4 (or AV mode).

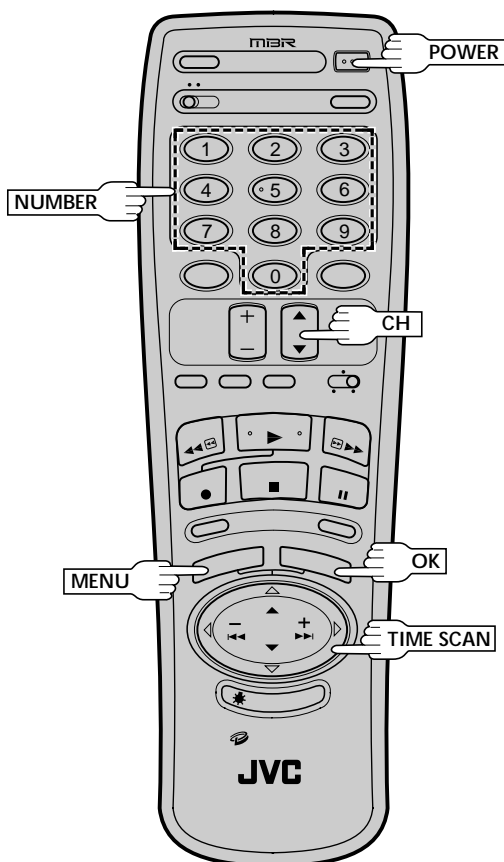
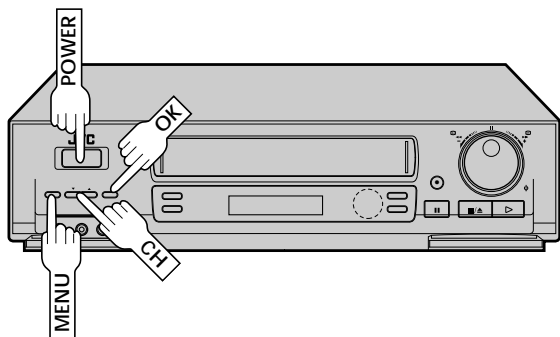

The VCR Plus+ timer programming system eliminates the need to input channel, date, start and stop time data when setting the timer record function. Simply key in the PlusCode number for the TV program you wish to record and the VCR's timer will be automatically programmed. (The PlusCodes are the numbers next to the programs in most TV listings.)

TV and cable stations can be received on different channel numbers depending on the area where they are received. Therefore to ensure that VCR Plus+Timer Recording operates correctly it may be necessary to set the VCR Plus+ "Guide Channel Set" for certain stations. Please read the following information carefully to find out which tasks you need to perform.

Before VCR Plus+ setup you must have performed the following procedures:

- Plug & Play (☞ pg. 7)

OR

- Clock setting (☞ pg. 9) and Tuner setting (☞ pg. 12)
- Cable box setting if you receive your TV channels through a cable box (☞ pg. 15)

VCR Plus+ Guide Channel Matching

VCR Plus+ assigns a VCR Plus+ "Guide Channel" to broadcast and cable TV channels. These Guide Channel numbers are also called the VCR Plus+ Channel Codes. Most TV listings have section, such as a chart, indicating the "Guide Channel" numbers assigned to each station. For accurate VCR Plus+ Programming the VCR Plus+ Guide Channel number for each station should match the channel number on which it is received in your area.

If the numbers match, go directly to "VCR Plus+ Timer Programming" (☞ pg. 42).

If the numbers are different, and you want to be able to timer record programs from those stations, you have to inform the VCR of the mismatch. Go to step 1. If you will not want to timer record from those stations, you can go directly to "VCR Plus+ Timer Programming" (☞ pg. 42).

NOTES:

- In many instances the VCR Plus+ Guide Channel numbers for cable and broadcast TV stations **DO NOT** match the channel number on which it is received by your VCR or cable box. Check your TV listing, or contact your cable supplier for details.
- If the VCR Plus+ Guide Channel numbers do not match, the wrong VCR/CABLE CH number will be displayed on the Program Screen when you enter the PlusCode for VCR Plus+ Programming. If this occurs set the correct VCR Plus+ Guide Channel to match this number.
- Many broadcast TV stations can be viewed on cable. Check your TV listing, or contact your cable supplier for details.

1 TURN ON THE VCR

Press **POWER**.

2 ACCESS MAIN MENU SCREEN

Press **MENU** as many times as necessary.

3 ACCESS CUSTOM SET SCREEN

Press **CH▲▼** or **TIME SCAN▲▼** to move the highlight bar (arrow) to "CUSTOM SET", then press **OK**.

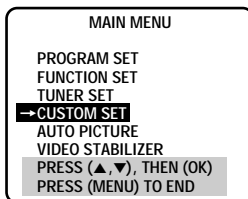

4 ACCESS VCR PLUS+ SET-UP SCREEN

Press **CH▲▼** or **TIME SCAN▲▼** to move the highlight bar (arrow) to "VCR PLUS+ SET-UP", then press **OK**.

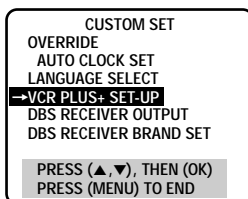

5 ACCESS GUIDE CHANNEL SET SCREEN

Press **CH▲▼** or **TIME SCAN▲▼** to move the highlight bar (arrow) to "GUIDE CHANNEL SET", then press **OK**.

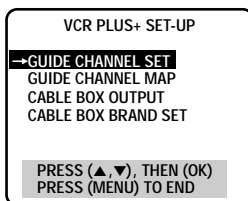

6 INPUT GUIDE CHANNEL NUMBER

Press **CH▲▼**, **TIME SCAN▲▼** or the appropriate **NUMBER** keys to input the VCR Plus+ Guide Channel number as shown in the TV listing. Then press **OK**.

- If you receive your channels with a cable box and if you have properly set your Controller, "CABLE CH" appears in place of "VCR CH". If not, refer to pages 15–16 and re-perform the procedure.

(Ex.) When inputting the Guide Channel number 6 for WJNJ(Ind.)

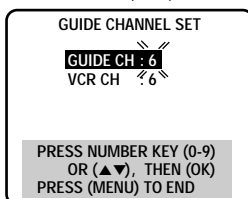

7 INPUT RECEIVING CHANNEL NUMBER

Press **CH▲▼**, **TIME SCAN▲▼** or the appropriate **NUMBER** keys to input the number of the channel on which the Guide Channel's broadcasts are received. Then press **OK**.

(Ex.) If WJNJ(Ind.) is received on channel 47

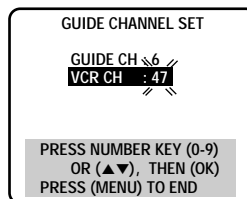

- If there is more than one mismatch, repeat steps 6 and 7 for each instance.

8 RETURN TO VCR PLUS+ SET-UP SCREEN

Press **MENU**.

9 CHECK INPUT DATA

Press **CH▲▼** or **TIME SCAN▲▼** to move the highlight bar (arrow) to "GUIDE CHANNEL MAP", then press **OK**.

- The Guide Channel and VCR or cable box channel numbers you input appear on the screen in ascending order. Check to ensure you've entered them correctly.
- If you entered more than 10 sets of numbers, press **OK** to see the next set of numbers.
- Guide Channel Map contains only the Guide Channels and VCR or CABLE channels that you entered.

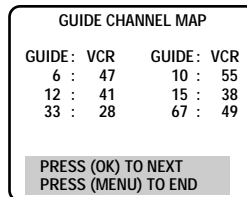
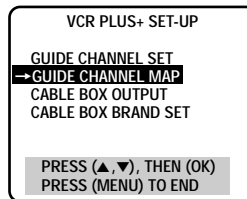

10 RETURN TO NORMAL SCREEN

Press **MENU** as many times as necessary.

You can now use VCR Plus+ for quick and simple timer programming (☞ pg. 42).

DBS Receiver Control

Suggested Location

Place the DBS (Direct Broadcast Satellite) receiver on top of the VCR. Attach the VCR's Controller to the top of the VCR with the Controller's transmitter pointed towards the DBS receiver's remote sensor.

Attention:

The Controller can also control a cable box. If both a DBS receiver and a cable box are used, position the controller so its signal reaches the remote control sensors of both the DBS receiver and cable box.

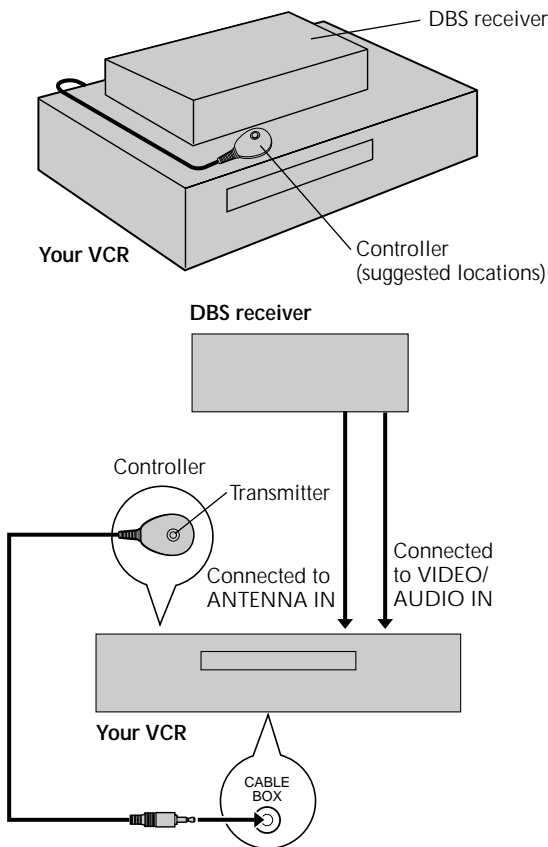

About Your DBS Receiver

This VCR has two separate methods to control your DBS Receiver.

- The VCR's Wireless Remote Control Unit can control your DBS Receiver. This eliminates the need for a separate DBS Receiver Remote Control Unit.
- The VCR's Controller can also control your DBS Receiver. This allows the VCR to change your DBS receiver's channel number during timer recording.

Each method must be set up separately. To set up the VCR's Remote Control unit, refer to page 57. To set up the Controller go to page 21.

The following procedure is required if you receive satellite channels through a DBS (Direct Broadcast Satellite) Receiver. The Controller allows the VCR to automatically switch the DBS Receiver's channels during timer recording.

The VCR can control the DBS Receiver during timer recording using its Controller.

NOTES:

- The Controller can automatically change the DBS Receiver channels when the VCR has been programmed using On-Screen Timer Programming (☞ pg. 44). Because satellite programming does not use PlusCode; the Controller can not change the DBS Receiver channels during VCR Plus+ Timer Recording.
- If a cable box is also used it is recommended that you connect the DBS receiver to your VCR's A/V inputs and the cable box to your VCR's antenna input.

Situate And Connect Controller

1 SITUATE CONTROLLER

Place the Controller so that the path between its transmitter and the DBS receiver's remote sensor is unobstructed.

2 ATTACH CONTROLLER

Fasten securely using the supplied adhesive strips.

3 CONNECT DBS RECEIVER TO VCR

The connection method depends on the type of DBS receiver you have.

If your DBS receiver has AUDIO and VIDEO OUT connectors . . .

. . . connect them to the AUDIO and VIDEO IN connectors on your VCR; select the correct external input mode as described in step 4, 5, 9 – 11 on page 50 & 51. Set the VCR to channel "AU" to use the DBS receiver.

If your DBS receiver doesn't have AUDIO and VIDEO OUT connectors . . .

. . . connect the antenna output connector on the DBS receiver to the ANTENNA IN connector on the rear of your VCR.

Set the VCR's tuner to the same channel as the DBS receiver's RF output. (See page 21 also.)

NOTE:

When connecting your DBS receiver refer to its instruction manual.

4 CONNECT CONTROLLER TO VCR

Connect to the CABLE BOX connector on your VCR.

Turn on the TV and select the VCR channel 3 or 4 (or AV mode).

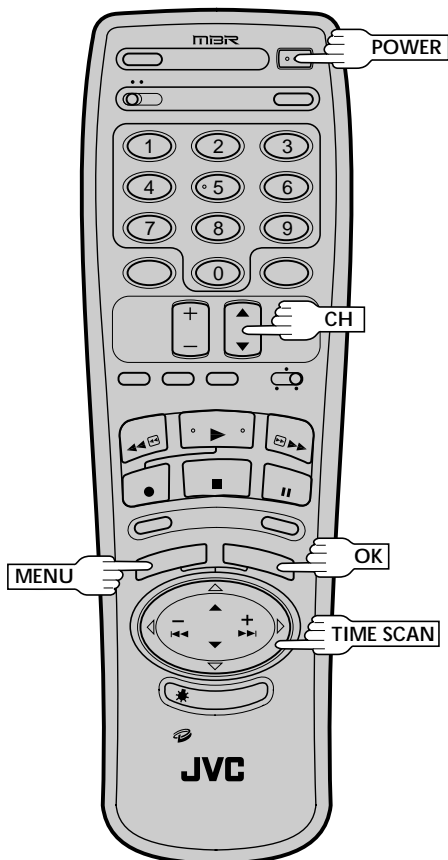
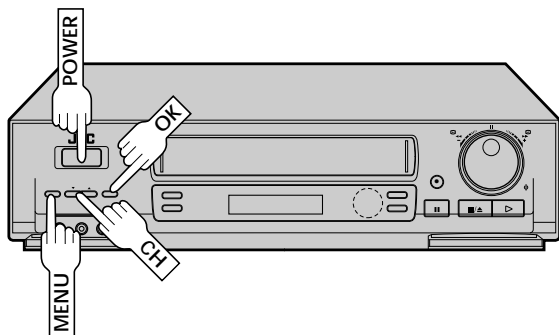

Set DBS Receiver Output Channel

1 TURN ON THE VCR

Press **POWER**.

- Set the VCR to the channel (3 or 4 or AU) on which the signals from the DBS receiver are received.

2 ACCESS MAIN MENU SCREEN

Press **MENU** as many times as necessary.

3 ACCESS CUSTOM SET SCREEN

Press **CH▲▼** or **TIME SCAN▲▼** to move the highlight bar (arrow) to "CUSTOM SET", then press **OK**.

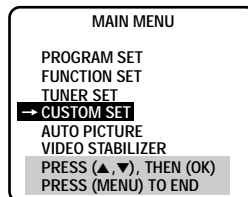

4 ACCESS DBS RECEIVER OUTPUT SCREEN

Press **CH▲▼** or **TIME SCAN▲▼** to move the highlight bar (arrow) to "DBS RECEIVER OUTPUT", then press **OK**.



5 SELECT DBS RECEIVER OUTPUT CHANNEL

Your selection depends on how your DBS receiver is connected to your VCR.

If your DBS receiver is connected to your VCR using an RF connection . . .

. . . press **CH▲▼** or **TIME SCAN▲▼** to move the highlight bar (arrow) to the channel number representing the DBS receiver's output (3-4).

If your DBS receiver is connected to your VCR's AUDIO/VIDEO IN connectors . . .

. . . press **CH▲▼** or **TIME SCAN▲▼** to move the highlight bar (arrow) to "ON LINE".

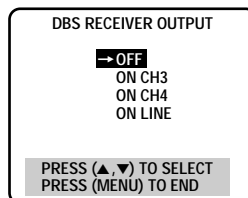

6 RETURN TO CUSTOM SET SCREEN

Press **MENU**.

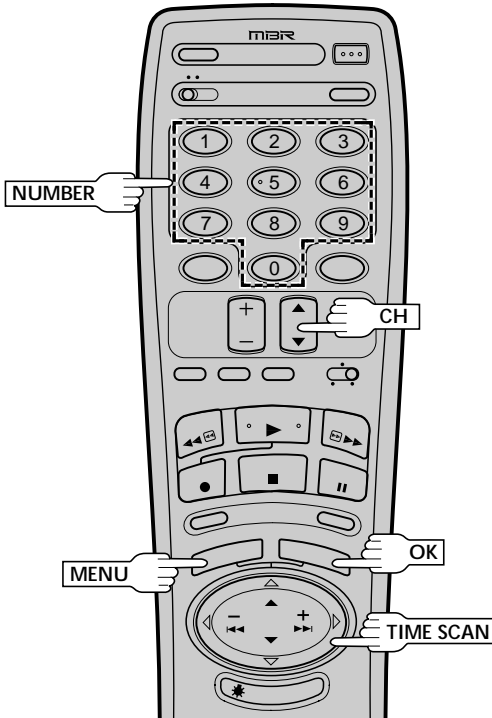
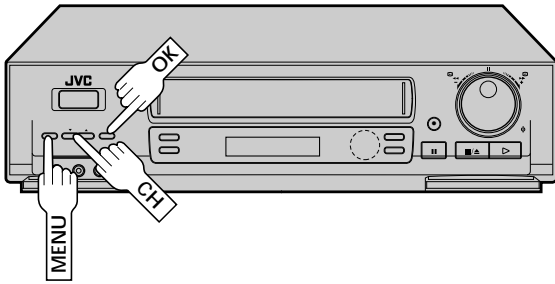

NOTES:

- It is possible that the Controller will not work with all types of DBS receiver.
- If your DBS receiver doesn't respond to the code, you can't use the Controller to change satellite channels. In this case, make sure to leave the DBS receiver turned on and tuned to the proper channel before the scheduled start of timer recording.
- The VCR can only change the satellite channel through the Controller during timer recording.
- If your DBS receiver is one that can't be operated with a remote control (because it has no remote sensor), you can't use the Controller to change its channels. Make sure to leave the DBS receiver turned on and tuned to the proper channel before the scheduled start of timer recording.
- **For customers in U.S.A.:** If you are unable to set the Controller, please contact JVC toll free at 1-800-252-5722.

Set DBS Receiver Brand

1

TURN ON DBS RECEIVER

Select a channel other than channel 55, 100 or 205 on your DBS receiver.

2

ACCESS DBS RECEIVER BRAND SET SCREEN

At the Custom Set screen, press **CH▲▼** or **TIME SCAN▲▼** to move the highlight bar (arrow) to "DBS RECEIVER BRAND SET", then press **OK**.

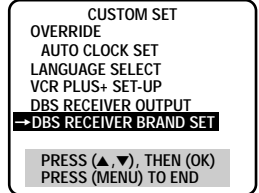

3

ENTER DBS RECEIVER BRAND

Press the appropriate **NUMBER** keys to enter the DBS Receiver Code from the following list, then press **OK**.

The unit is pre-set to code 80 (RCA) when shipped.



BRAND	CODE
RCA (DSS)	80
SONY (DSS)	81
PRIMESTAR	90
ECHOSTAR	91

- If the DBS receiver's channel changes as follows, setting is complete:
 RCA or SONY → 205
 PRIMESTAR → 55
 ECHOSTAR → 100
- After **OK** is pressed, the program currently received through the DBS receiver will appear for about 10 seconds.

4

RETURN TO NORMAL SCREEN

Press **MENU** as many times as necessary.

Simple Playback

Turn on the TV and select the VCR channel 3 or 4 (or AV mode).

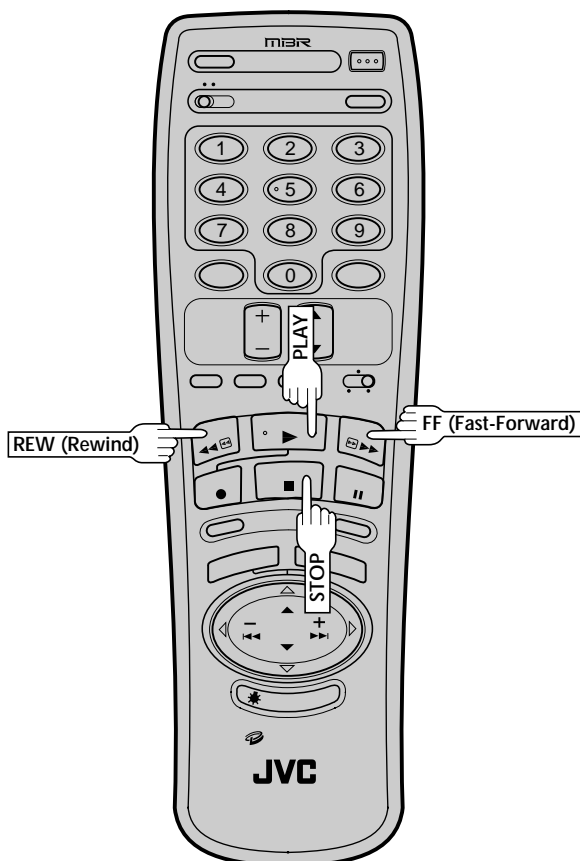
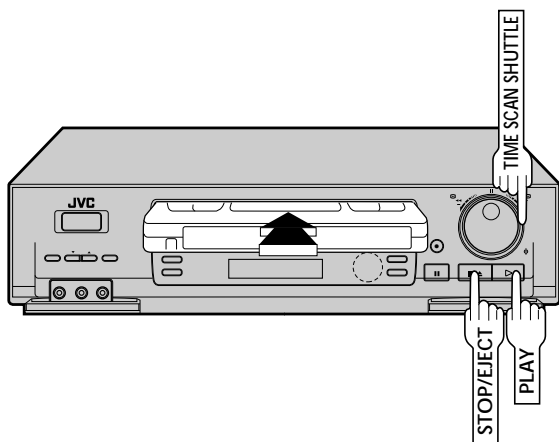

1 LOAD A CASSETTE

Make sure the window side is up, the rear label side is facing you and the arrow on the front of the cassette is pointing towards the VCR. Don't apply too much pressure when inserting.

- The VCR's power comes on automatically.
- The counter is automatically reset to "0H 00M 00S".
- If the cassette's record safety tab has been removed, playback begins automatically.

2 FIND PROGRAM START POINT

If the tape is advanced past the start point, press **REW** or turn the **TIME SCAN SHUTTLE** ring to the left. To go forward, press **FF** or turn the **TIME SCAN SHUTTLE** ring to the right.

3 START PLAYBACK

Press **PLAY**. "AUTO PICTURE" appears on screen (see pg. 35).

4 STOP PLAYBACK

Press **STOP** or **STOP/EJECT**. Then press **STOP/EJECT** to remove the cassette.

Usable cassettes

Full-Size VHS
T-30 (ST-30**)
T-60 (ST-60**)
T-90
T-120 (ST-120**)
T-160 (ST-160**)
ST-210**

Compact VHS*
TC-20 (ST-C20**)
TC-30 (ST-C30**)
TC-40 (ST-C40**)

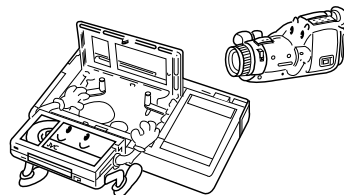

* Compact VHS camcorder recordings can be played on this video recorder. Simply place the recorded cassette into a VHS Cassette Adapter and it can be used just like any full-sized VHS cassette.

** This video recorder can record on regular VHS and Super VHS cassettes. However, it will record and play back regular VHS signals only. It is not possible to play back Super VHS recordings.

Simple Recording

Turn on the TV and select the VCR channel 3 or 4 (or AV mode).

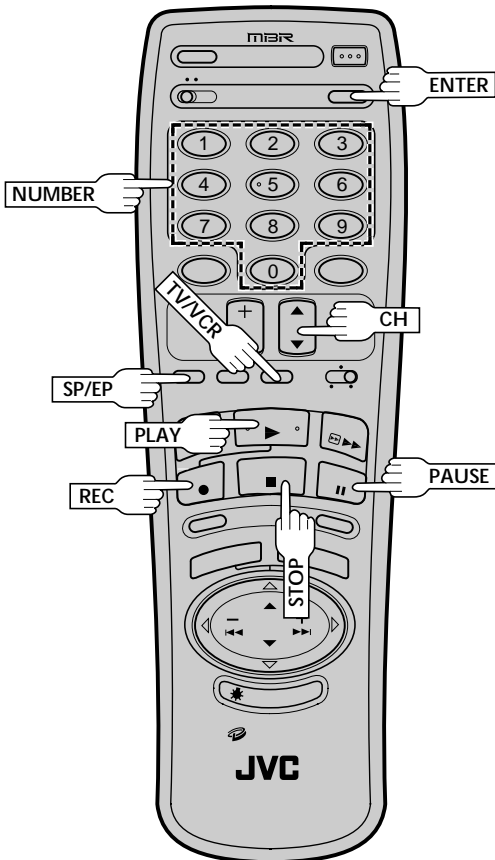
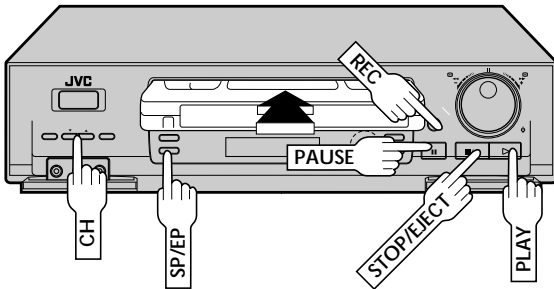

1 LOAD A CASSETTE

Make sure the record safety tab is intact. If not, cover the hole with adhesive tape before inserting the cassette.

2 SELECT RECORDING CHANNEL

Press **CH▲▼**. Or press the appropriate **NUMBER** keys, then press **ENTER**. (The channel changes after a few seconds whether you press **ENTER** or not.)

- If you use the RF connection, by pressing the **TV/VCR** button, select VCR mode to view the program to be recorded.

3 SET TAPE SPEED

Press **SP/EP** to set the recording speed.

4 START RECORDING

Press and hold **REC** and press **PLAY** on the remote control, or press **REC** on the VCR's front panel.

5 PAUSE/RESUME RECORDING

Press **PAUSE**. Press **PLAY** to resume recording.

- During record pause, you can change the recording channel by using the **CH▲▼** buttons or **NUMBER** keys.

6 STOP RECORDING

Press **STOP** or **STOP/EJECT**. Then press **STOP/EJECT** to remove the cassette.

Accidental erasure prevention

- To prevent accidental recording on a recorded cassette, remove its record safety tab. To record on it later, cover the hole with adhesive tape.

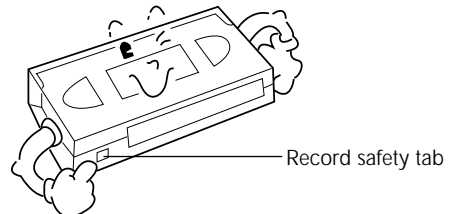

Playback Features

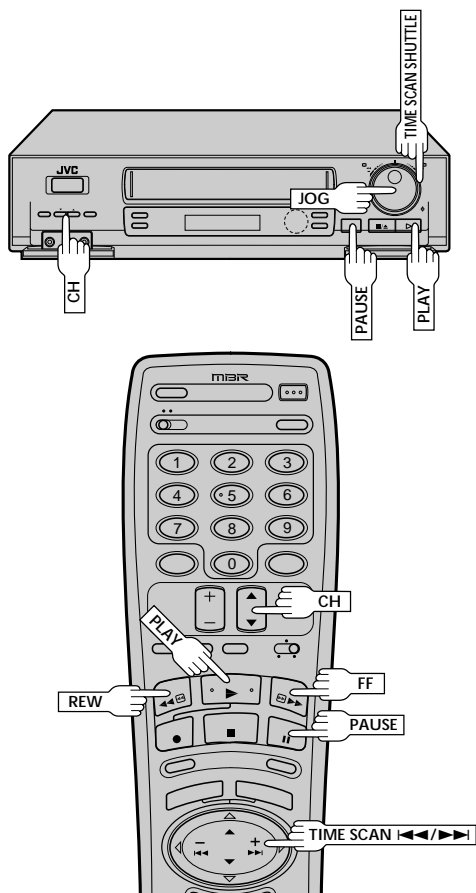

High-Speed Search

1

ACTIVATE HIGH-SPEED SEARCH

During playback or still, press **FF** for forward high-speed search, or **REW** for reverse high-speed search.

- The search speed is 7 times normal playback speed with SP recordings, and 21 times normal with EP recordings.
- TimeScan will be automatically engaged during high-speed search with an SP-recorded tape.
- If the tape speed changes from SP to EP during high-speed search the TimeScan mode will change to EP search mode.
- Press **TIME SCAN** for the opposite direction or turn the **TIME SCAN SHUTTLE** ring to the opposite direction during high-speed search of an EP-recorded tape to change to 7x TimeScan search. (pg. 36)

To resume normal playback, press **PLAY**.

NOTE:

For short searches, during playback or still, press and hold **FF** or **REW** for over 2 seconds. When released, normal playback resumes.

Still Picture/Frame-By-Frame Playback

1

PAUSE DURING PLAYBACK

Press **PAUSE**. If there is vertical jitter, use the **CH ▲** or **▼** button to correct the picture.

- During still picture, the normal (mono) sound from the previous 3 seconds (approx.) will be played back repeatedly (provided there was at least 6 seconds of normal playback prior to engaging the still picture mode).
- "TIMESCAN AUDIO" must be set to "ON", or the sound will not be heard (pg. 38).

2

ACTIVATE FRAME-BY-FRAME PLAYBACK

Turn the **JOG** dial to the right for forward frame-by-frame playback, or to the left for reverse frame-by-frame playback.

OR

Press **PAUSE** repeatedly to advance one frame at a time.

OR

Press **TIME SCAN ►►** repeatedly for forward frame-by-frame playback or **TIME SCAN ◄◄** repeatedly for reverse frame-by-frame playback.

To resume normal playback, press **PLAY**.

Slow Motion/Reverse Slow Motion

1

ACTIVATE SLOW-MOTION PLAYBACK

For hands-free slow-motion, turn the **TIME SCAN SHUTTLE** ring one or two positions to the left or press **TIME SCAN ◄◄** during playback to decrease speed in the forward direction. Continue to turn the **TIME SCAN SHUTTLE** ring to the left or press **TIME SCAN ◄◄** to select the two reverse slow motion, reverse play and reverse search modes.

OR

During still picture, turn the **TIME SCAN SHUTTLE** ring one or two positions to the right for forward slow motion, or to the left for reverse slow motion.

OR

During still picture, press and hold **TIME SCAN ►►** for forward slow motion, or press and hold **TIME SCAN ◄◄** for reverse slow motion. Release to return to still picture.

To resume normal playback, press **PLAY**.

Refer to the chart on Pg.37 for the Play, Slow Motion and Search speeds that are selected using the **TIME SCAN SHUTTLE** ring or **TIME SCAN** remote control buttons.

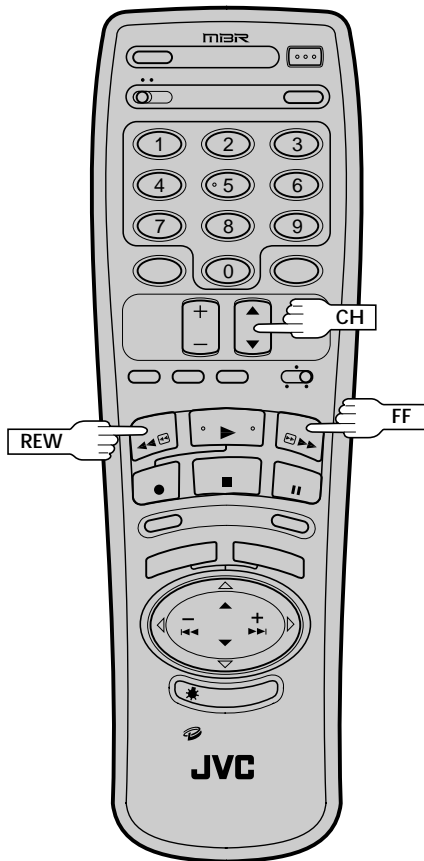
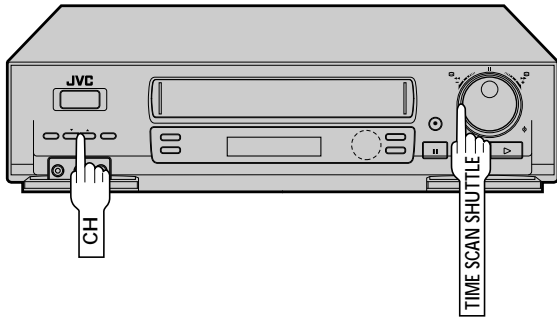

Manual Tracking

Once playback begins, the VCR's automatic tracking function is engaged. If noise appears in the picture, you can override this and make the adjustment manually.

1 ENGAGE MANUAL TRACKING MODE

During playback, press the CH▲ and ▼ buttons on the VCR's front panel simultaneously to cancel the automatic tracking mode and enable manual tracking adjust.

2 ADJUST MANUAL TRACKING

Press CH▲ or ▼ on the VCR's front panel or remote. Press briefly for fine adjust, or press and hold for coarse adjust. Watch the screen and continue adjusting until optimum picture and sound quality are achieved.

3 RE-ENGAGE AUTOMATIC TRACKING

Press the CH▲ and ▼ buttons on the VCR's front panel simultaneously.

- When automatic tracking is re-engaged, Auto Picture is automatically activated.

NOTES:

- To obtain a noiseless still picture it may be necessary to adjust tracking in slow playback and then engage Pause.
- Manual tracking is possible during hands-free slow-motion. During hands-free slow-motion playback, simply press CH▲ or ▼ on the VCR's front panel or remote to adjust tracking.

Tape Position Indicator

The Tape position indicator appears on screen when, from the stop mode, you press FF, REW, or use the TIME SCAN SHUTTLE ring, or perform an Index Search or Instant ReView. The position of "■" in relation to "B" (Beginning) or "E" (End) shows you where you are on the tape.

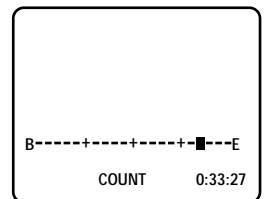

NOTES:

- "SUPERIMPOSE" must be set to "ON", or the indicator will not appear (pg. 28).
- It may take a few seconds for the Tape Position Indicator to be displayed.

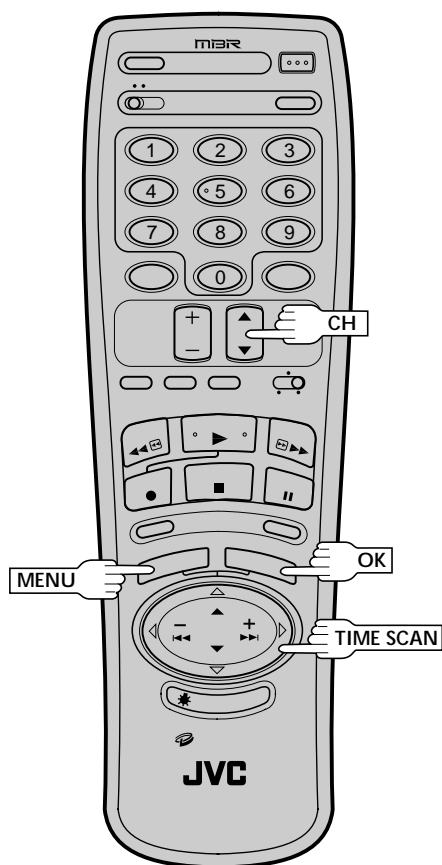
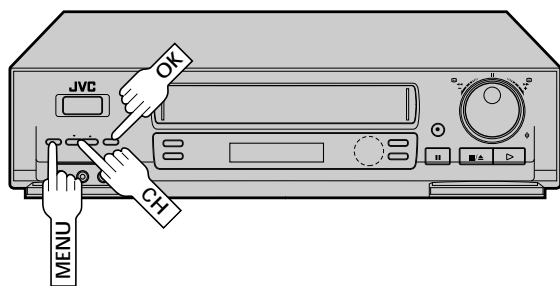

Video Stabilizer

By activating the Video Stabilizer you can correct vertical vibrations in the picture when playing back unstable EP recordings that were made on another VCR. When this function is set to "ON", vertical vibration will be automatically corrected. *The default setting is "OFF".

1 ACCESS MAIN MENU SCREEN

Press **MENU** as many times as necessary.

2 ACCESS VIDEO STABILIZER SCREEN

Move the highlight bar (arrow) to "VIDEO STABILIZER" by pressing **CH▲▼** or **TIME SCAN▲▼**, then press **OK**.

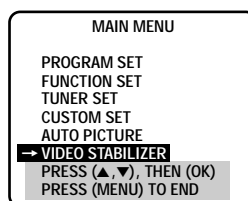

3 ACTIVATE VIDEO STABILIZER

Move the highlight bar (arrow) to "ON" by pressing **CH▲▼** or **TIME SCAN▲▼**.

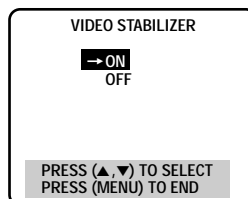

4 RETURN TO NORMAL SCREEN

Press **MENU**.

NOTES:

- Regardless of the setting, this function has no effect with SP recordings, during recording and during special-effects playback.
- When you finish viewing the tape, be sure to set it back to "OFF".

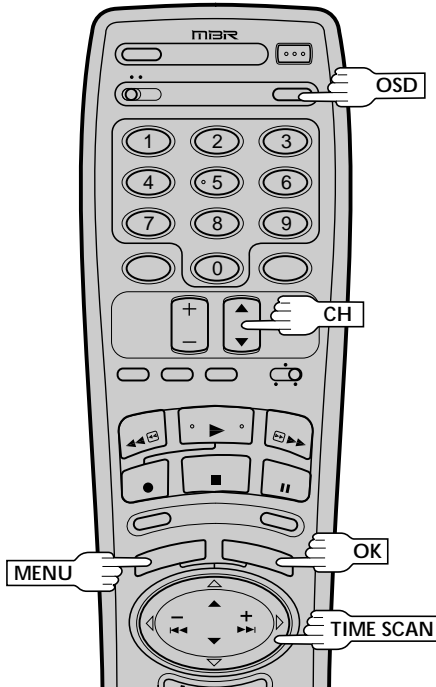
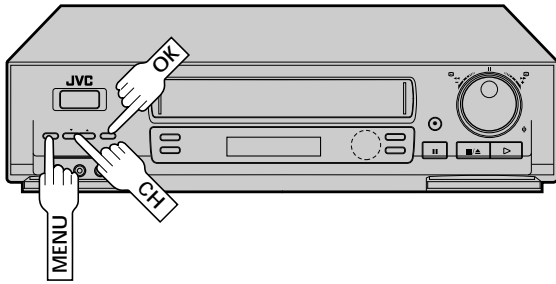

To recall an indication

- 1 Press **OSD**.
 - All indications corresponding to the current status are displayed for 5 seconds, leaving the counter information, and RECORD/PAUSE if in the Record Pause mode, on the screen.
- 2 Press **OSD** again to clear the display.

Superimpose

This function, switchable between ON and OFF, determines whether or not operational indicators will appear on screen.

1 ACCESS MAIN MENU SCREEN

Press **MENU** as many times as necessary.

2 ACCESS FUNCTION SET SCREEN

Move the highlight bar (arrow) to "FUNCTION SET" by pressing **CH▲▼** or **TIME SCAN▲▼**, then press **OK**.

3 ACCESS SUPERIMPOSE SCREEN

Move the highlight bar (arrow) to "SUPERIMPOSE" by pressing **CH▲▼** or **TIME SCAN▲▼**, then press **OK**.

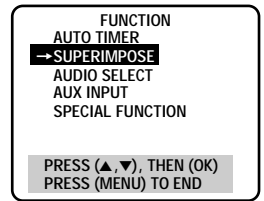

4 SELECT MODE

Move the highlight bar (arrow) to "ON" or "OFF" by pressing **CH▲▼** or **TIME SCAN▲▼**.

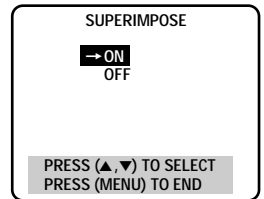

5 RETURN TO NORMAL SCREEN

Press **MENU** as many times as necessary.

NOTE:

If you engage the Record Pause mode, RECORD/PAUSE is displayed whether "SUPERIMPOSE" is set to "ON" or "OFF".

The superimposed indication on the TV screen tells you what the VCR is doing.

- Tuned-in channel or AUX(iliary) mode**
When the channel is changed, the new channel is displayed on the screen for 5 seconds.
- Clock time**
- Tape position indicator**
- "Cassette Loaded" mark**
When a cassette is loaded, the mark is displayed for 5 seconds. It blinks when the VCR's EJECT button is pushed.

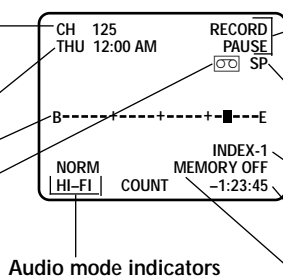

- Operation mode**
When the operation mode is changed, the new mode is displayed — RECORD (5 sec.), PLAY (5 sec.), FF/REW (5 sec. when engaged from Stop mode), RECORD PAUSE (for as long as Pause is engaged), and ITR **:*(5 sec.).
- Tape speed indicator**
- INDEX indication**
- Counter reading**
- Counter memory on/off**

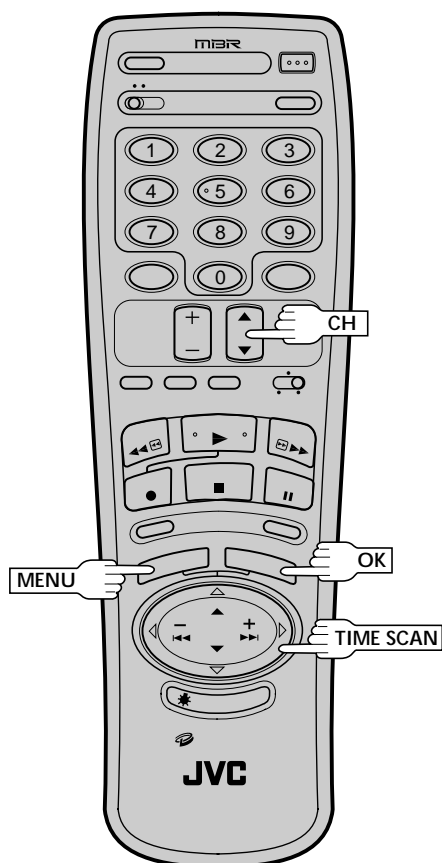
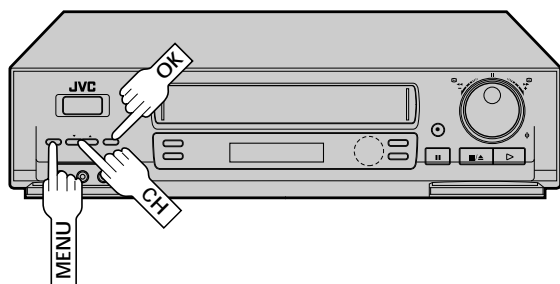

Select The Soundtrack

Your VCR can record two soundtracks simultaneously (Normal and Hi-Fi) and play back the selected one, or both together.

1

ACCESS MAIN MENU SCREEN

Press **MENU** as many times as necessary during playback or when VCR is in stop mode.

2

ACCESS FUNCTION SET SCREEN

Move the highlight bar (arrow) to "FUNCTION SET" by pressing **CH▲▼** or **TIME SCAN▲▼**, then press **OK**.

3

ACCESS AUDIO SELECT SCREEN

Move the highlight bar (arrow) to "AUDIO SELECT" by pressing **CH▲▼** or **TIME SCAN▲▼**, then press **OK**.

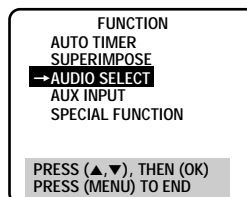

4

ACCESS AUDIO MONITOR SCREEN

Move the highlight bar (arrow) to "AUDIO MONITOR" by pressing **CH▲▼** or **TIME SCAN▲▼**, then press **OK**.

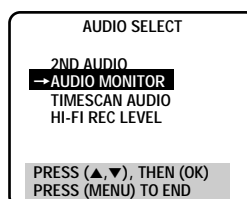

5

SELECT MODE

You have three choices:

- a- Hi-Fi
- b- Normal
- c- Mix

Move the highlight bar (arrow) to your choice by pressing **CH▲▼** or **TIME SCAN▲▼**.



6

RETURN TO NORMAL SCREEN

Press **MENU** as many times as necessary.

NOTES:

- If the tape being played back has no Hi-Fi soundtrack, the Normal soundtrack will be heard no matter what choice you make at the Audio Monitor screen.
- If you select "HI-FI" or "MIX", the L and R symbols near the audio level meters will be illuminated. L and R will be deactivated when playing back a normal (mono) tape.
- If RF connection is used for TV, even if Hi-Fi audio monitor is selected the sound will be mono and will be reproduced in both loudspeakers.

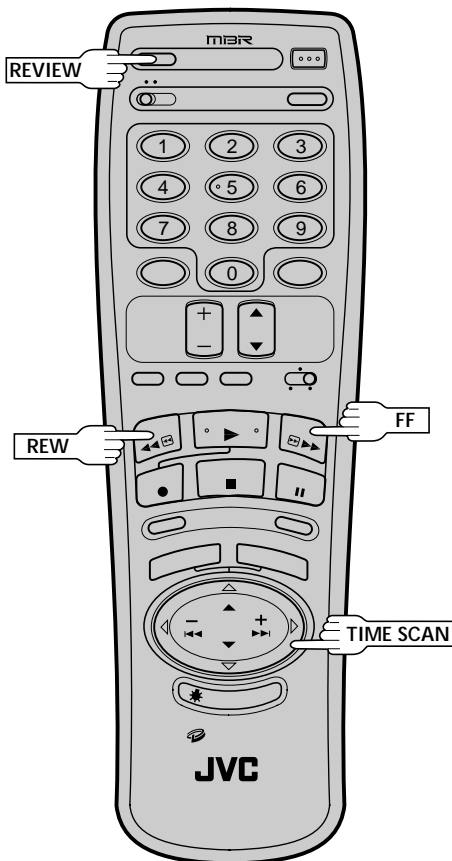
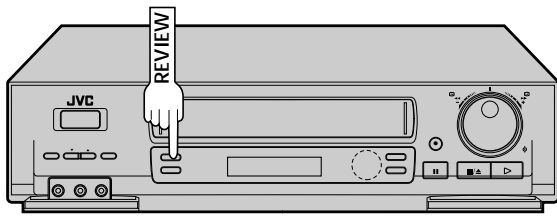

Index Search

Index codes are placed on the tape at the start of each recording. You can find and automatically play back from the start of any recording using the Index Search function.

1 START SEARCH

While the tape is stopped, press **TIME SCAN** \lll or \ggg .

2 ACCESS DISTANT CODE

To access a recording 2–9 index codes away, press **TIME SCAN** \lll or \ggg repeatedly until the correct number is displayed on screen (only if SUPERIMPOSE is set to ON (pg. 28)). Playback begins automatically when the desired recording is located.

- If necessary press **REW** or **FF** when play starts to search visually to find the very beginning of the desired program.

NOTE:

An index code is not placed on the tape when recording is paused and then resumed.

Instant ReView

At the press of a button, you can power up your VCR, rewind the tape and begin viewing the most recent timer-recorded program.

1 ACTIVATE INSTANT REVIEW

After ensuring that the Timer mode is disengaged, press **REVIEW**.

- The power comes on and the VCR rewinds to the index code indicating the start of the last timer-recorded program, then begins playback automatically.
- You can access a program 2–9 index codes away from the current position on the tape. If, for example, you have 5 programs recorded and you want to watch the third one, press **REVIEW** three times.
- If necessary press **REW** or **FF** when play starts to search visually to find the very beginning of the desired program.
- If the tape is already rewound when **REVIEW** is pressed, it will play the tape from the beginning. It will not fast forward to an index code.
- The Instant Review function will also operate if the VCR's power is on.

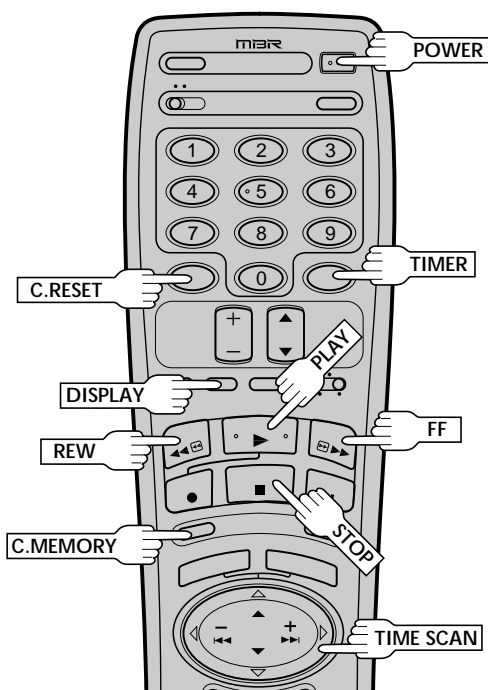
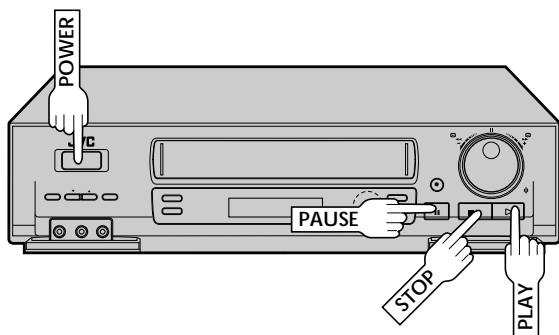

Next-Function Memory

The Next Function Memory "tells" the VCR what to do after rewinding. * Before continuing, ensure that the VCR is in stop mode.

- a- For Automatic Start Of Playback After Tape Rewind . . . press **REW**, then press **PLAY** within 2 seconds.
- b- For Automatic Power Off After Tape Rewind . . . press **REW**, then press **POWER** within 2 seconds.
- c- For Automatic Timer Standby After Tape Rewind . . . press **REW**, then press **TIMER** within 2 seconds.

NOTE:

- If you want the "next function" to automatically start when the counter reads "0H 00M 00S" (instead of at the beginning of the tape), press **C. MEMORY** so that the counter memory indicator appears on the front display panel before pressing **REW**.
- It is not possible to select the Automatic Timer functions if the cassette's record safety tab is removed.

Repeat Playback

1 START REPEAT

Press and hold **PLAY** (until "PLAY" blinks on the front display panel) during playback, then release.



- The entire tape is played back 20 times.

2 STOP REPEAT

To stop, press **STOP** at any time.

NOTE:

Pressing **PLAY**, **REW**, **FF**, **PAUSE** or **TIME SCAN** ◀◀ or ▶▶ also stops Repeat Playback.

Counter Reset

1 RESET COUNTER TO ZERO

Press **C.RESET**.

NOTE:

By pressing the **DISPLAY** button, you can change the display to show the counter reading, channel number or clock time. (Channel number is not displayed during playback.)

Counter Memory

When **REW** or **FF** is pressed, with the Counter Memory activated, the tape will return to the counter position "zero".

1 ACTIVATE COUNTER MEMORY

Press **C.RESET** during playback at a point you want to have quick access to later. The counter reads "0H 00M 00S".

Then press **C.MEMORY**. The Counter Memory indicator ("M") in the front display panel lights.

2 RETURN TO COUNTER POSITION ZERO

Press **STOP** (during playback), then press **REW** or **FF**. The tape rewinds or fast-forwards and stops at approximately "0H 00M 00S" automatically.

- To cancel Counter Memory, press **C.MEMORY**.

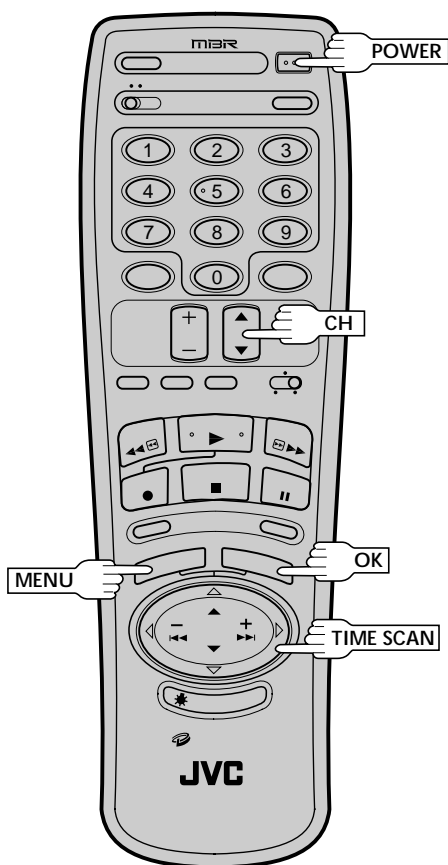
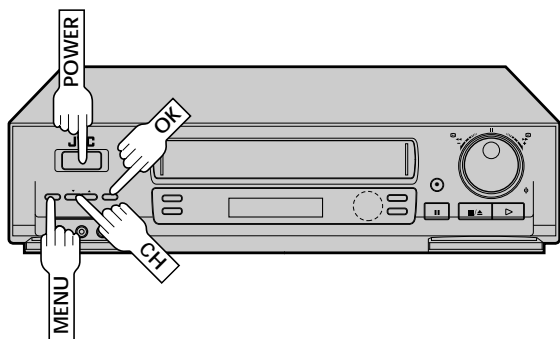

AV COMPU LINK Playback

Your VCR is compatible with JVC's AV COMPU LINK components, including amplifiers (or receivers) and televisions. AV COMPU LINK provides one touch control of the audio and video components that are linked via their AV COMPU LINK connectors.

For example: simply load a cassette in the VCR and press **PLAY** and the AV COMPU LINK components automatically power on, the TV's AV mode is selected and the VCR goes into play mode. (PLAY need not be pressed if the cassette's record safety tab is removed.)

1 MAKE CONNECTION

Connect your VCR to an AV COMPU LINK component as shown in the illustration on page 33.

- The mini-plug cable is a mono 3.5 mm mini-plug to mono 3.5 mm mini-plug connector.

2 TURN ON THE VCR

Press **POWER**.

3 ACCESS MAIN MENU SCREEN

Press **MENU** as many times as necessary.

4 ACCESS FUNCTION SET SCREEN

Press **CH▲▼** or **TIME SCAN▲▼** to move the highlight bar (arrow) to "FUNCTION SET", then press **OK**.

5 ACCESS SPECIAL FUNCTION SCREEN

Press **CH▲▼** or **TIME SCAN▲▼** to move the highlight bar (arrow) to "SPECIAL FUNCTION", then press **OK**.

FUNCTION
 AUTO TIMER
 SUPERIMPOSE
 AUDIO SELECT
 AUX INPUT
 → SPECIAL FUNCTION

PRESS (▲, ▼), THEN (OK)
 PRESS (MENU) TO END

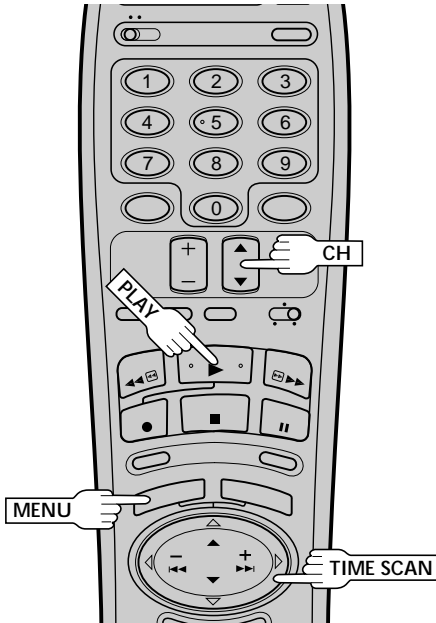
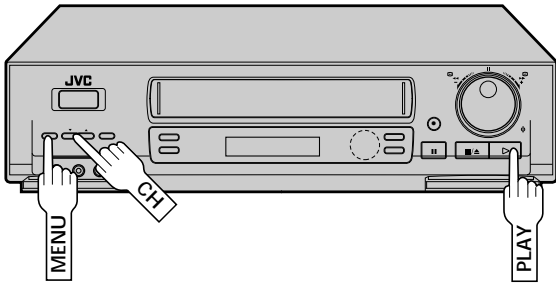

6

ENABLE AV COMPU LINK PLAYBACK

Press **CH**▲▼ or **TIME SCAN**▲▼ to move the highlight bar (arrow) to "AV COMPU LINK".

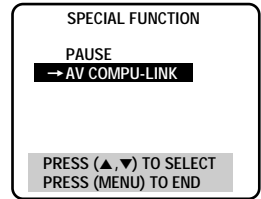

7

RETURN TO NORMAL SCREEN

Press **MENU** as many times as necessary.

8

PERFORM AV COMPU LINK PLAYBACK

Simply insert a cassette and press **PLAY** (if the cassette's record safety tab has been removed, playback begins automatically). Linked components are turned on, and the TV set to its AV mode, automatically!

NOTE:

Connection varies depending on the type of JVC TV you have. Please refer to the TV's instruction manual when making this connection.

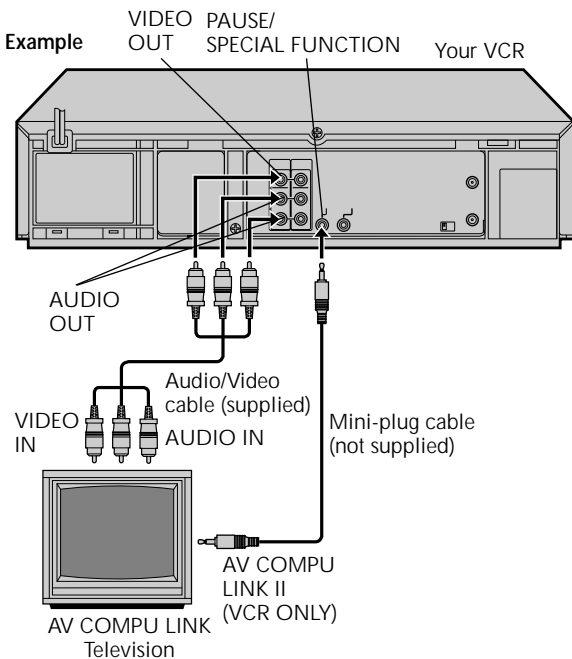

Auto Picture

Turn on the TV and select the VCR channel 3 or 4 (or AV mode).

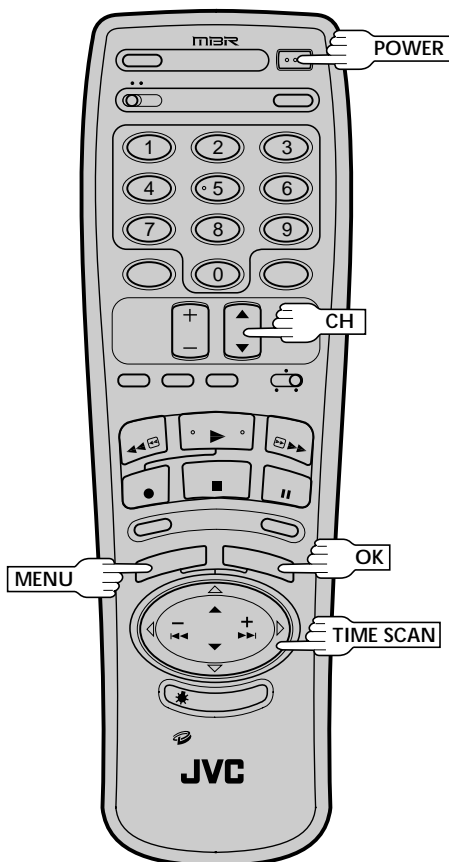
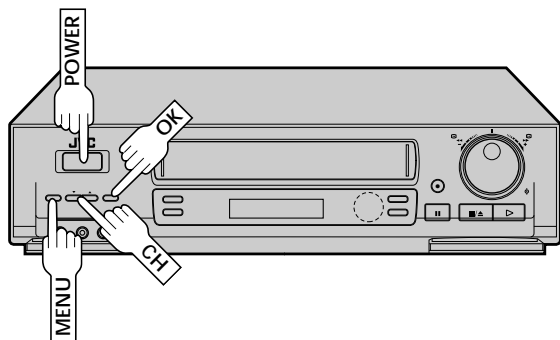

Auto Picture compensates for variations in tape characteristics to ensure the best possible playback picture. It checks and compensates for the condition of the tape at the beginning of automatic tracking when playback is selected. The default setting is "ON".

Preparation

1 TURN ON THE VCR

Press **POWER**.

2 ACCESS MAIN MENU SCREEN

Press **MENU** as many times as necessary.

3 ACCESS AUTO PICTURE SCREEN

Press **CH▲▼** or **TIME SCAN▲▼** to move the highlight bar (arrow) to "AUTO PICTURE", then press **OK**.

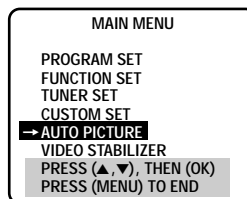

4 SELECT MODE

Move the highlight bar (arrow) to "ON" by pressing **CH▲▼** or **TIME SCAN▲▼**.

NOTE:

When using rental tapes, or tapes recorded on other VCRs, select "ON" or "OFF" as desired to give the best picture.

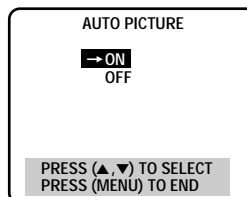

5 RETURN TO NORMAL SCREEN

Press **MENU**.

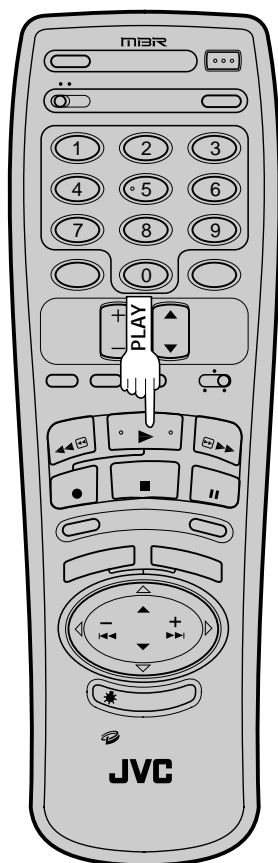
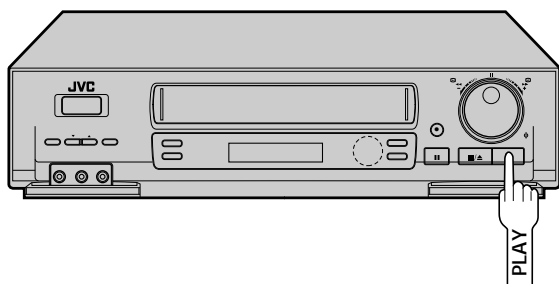

Playback

When Auto Picture is activated the VCR will assess the quality of the tape the first time it is played back after the cassette is loaded.

To play a tape first perform steps 1 and 2 on page 23 ("Simple Playback").

START PLAYBACK

1

Press **PLAY**.

- The VCR adjusts the playback picture quality based on the quality of the tape in use.

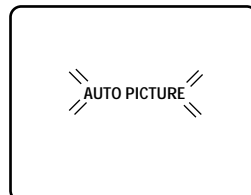

NOTES:

- The Auto Picture screen only appears at the beginning of automatic tracking. However even though the screen doesn't appear after that, the Auto Picture function is operative.
- SUPERIMPOSE must be set to "ON" if the Auto Picture screen is to be displayed (pg. 28).

TimeScan

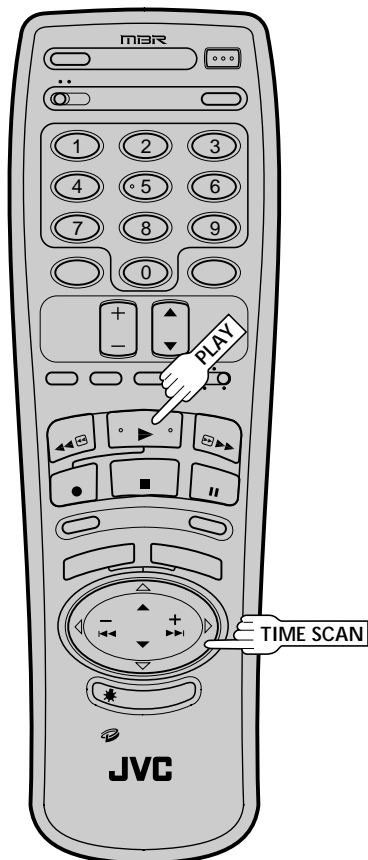
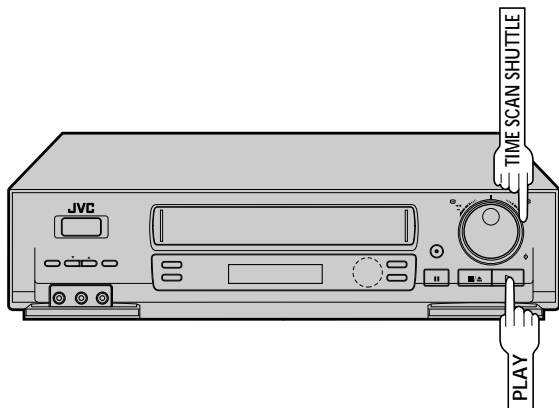

Your VCR is equipped with the TimeScan function. TimeScan allows noise free pictures to be displayed on your TV screen in the forward and reverse search modes. Audio will be played back at normal speed during any of the TimeScan modes (☞ pg. 37). TimeScan allows you to view a program in search mode while listening to the audio.

NOTES:

- "TIMESCAN AUDIO" must be set to "ON", or the sound will not be heard in TimeScan mode (☞ pg. 38).
- The audio will not synchronize with the video in TimeScan modes.
- In Pause mode 3 seconds (approx.) of audio will be played back repeatedly. (☞ pg. 25)
- In TimeScan search modes some of the audio information will not be played so that the audio can keep up with the video.

Audio signal during TimeScan

Playback tape

1	2	3	4	5
---	---	---	---	---

Sound of 1, 3 and 5 is heard.

Sound of 2 and 4 is not heard.

Output audio signal is normal (monaural) sound.

Variable-Speed Search/ Reverse Motion Playback

ACTIVATE VARIABLE-SPEED SEARCH

1

During playback or still, turn the VCR's **TIME SCAN SHUTTLE** ring. It remains at that position even after you release it. Each time it passes a click position, the playback speed changes. (Refer to the chart on pg 37 for playback speeds).

OR

During playback, momentarily press **TIME SCAN** ◀◀ or ▶▶.

- To increase the speed in the forward direction, press ▶▶ repeatedly to select the various forward search modes.
- To decrease the speed in the forward direction, press ◀◀.
- To play in reverse slow motion, and in reverse play mode, continue to press ◀◀ after selecting all the forward slow motion modes. (Refer to the chart on pg 37 for playback speeds).

To resume normal playback, press **PLAY**.

TimeScan

Names of special-effects playback	Reverse							Forward						
	Search			Play	Slow-Motion		*Still	Slow-Motion		Play	Search			
Speed	-7x	-5x	-3x	-1x	-1/6x	-1/18x	0	1/18x	1/6x	1x	2x	3x	5x	7x
Audio output	Audio is output.				Audio is not output.		Audio is output.	Audio is not output.		Audio is output.				

* Still mode cannot be engaged using the remote control's **TIME SCAN** button.

- The speed is shown in the upper right corner of the TV screen for approx. 5 seconds.
- The TimeScan search speed is the same for SP and EP recordings.
- To resume normal playback, press **PLAY**.
- The playback speed may not change correctly if the VCR's **TIME SCAN SHUTTLE** ring is turned too quickly.
- When using the VCR's **TIME SCAN SHUTTLE** ring, the playback speed will change up to 7x and -7x search speeds. Turning the **TIME SCAN SHUTTLE** ring further will not increase the search speed.
- Picture may be distorted at the position where the recording speed is switched.
- The picture may be noisy for a moment when you change the playback speed.
- During high-speed search with a tape containing both SP and EP recordings, the search speed will change automatically to 7x normal playback speed with TimeScan when the recording tape speed switches from EP to SP.
- Depending on the tape in use, noise may appear or the upper part of the picture may be distorted.
- Picture may appear distorted in comparison to normal playback.
- In TimeScan mode there will be a time lag between the video and the audio and noise may appear in the audio signal.
- TimeScan sound quality will differ in comparison to normal playback.
- When material such as music videos where there is non-stop sound (very few breaks in the soundtrack) are viewed at 2x normal speed, the audio playback may be faster than normal.
- When the playback direction is reversed, it takes approximately 6 seconds until sound is heard.

If you don't want to hear TimeScan audio, set "**TIMESCAN AUDIO**" to "**OFF**" (pg. 38).

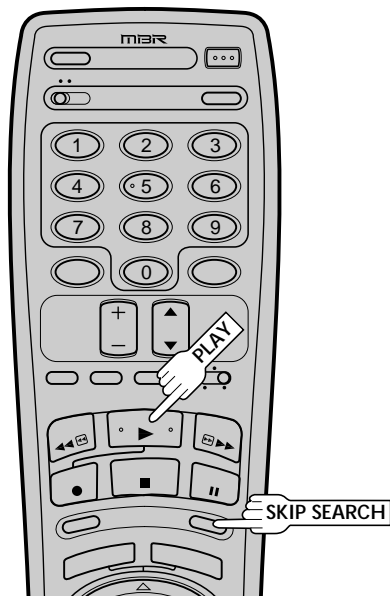

Skip Search

SKIP OVER UNWANTED SECTIONS

1 Press **SKIP SEARCH** 1 to 4 times during playback. Each press initiates a 30-second period of fast-motion playback. Normal playback resumes automatically.

NOTE:

To return to normal playback during a Skip Search, press **PLAY**.

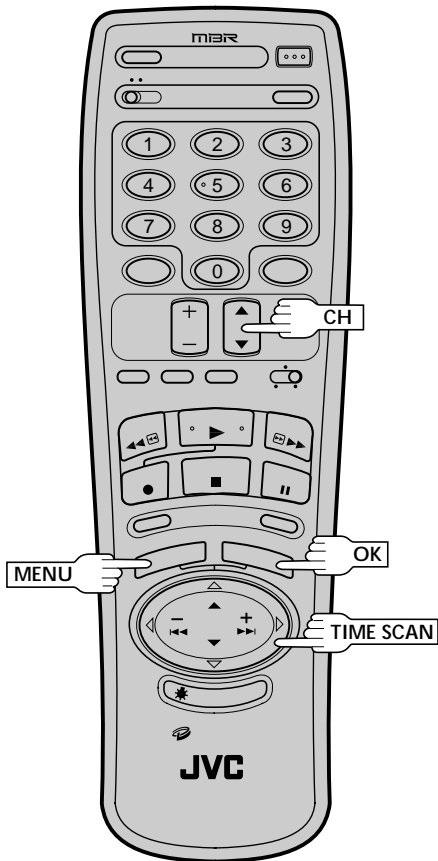
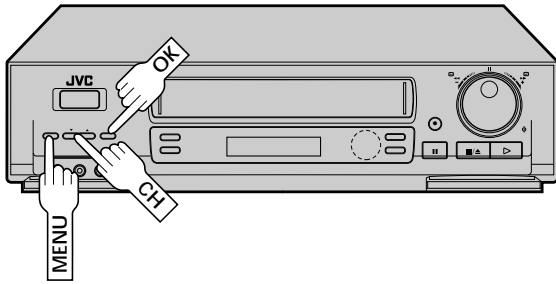

TimeScan Audio

The audio output can be set ON/OFF during TimeScan. Select ON/OFF as required.

*The default setting is "ON".

1 ACCESS MAIN MENU SCREEN

Press **MENU** as many times as necessary.

2 ACCESS FUNCTION SET SCREEN

Move the highlight bar (arrow) to "FUNCTION SET" by pressing **CH▲▼** or **TIME SCAN▲▼**, then press **OK**.

3 ACCESS AUDIO SELECT SCREEN

Move the highlight bar (arrow) to "AUDIO SELECT" by pressing **CH▲▼** or **TIME SCAN▲▼**, then press **OK**.

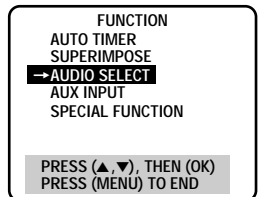

4 ACCESS TIMESCAN AUDIO SCREEN

Move the highlight bar (arrow) to "TIMESCAN AUDIO" by pressing **CH▲▼** or **TIME SCAN▲▼**, then press **OK**.

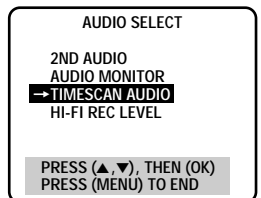

5 SELECT MODE

Move the highlight bar (arrow) to "ON" or "OFF" by pressing **CH▲▼** or **TIME SCAN▲▼**.

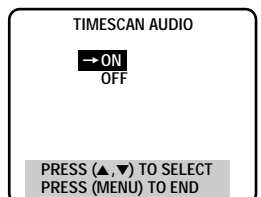

6 RETURN TO NORMAL SCREEN

Press **MENU** as many times as necessary.

Recording Features

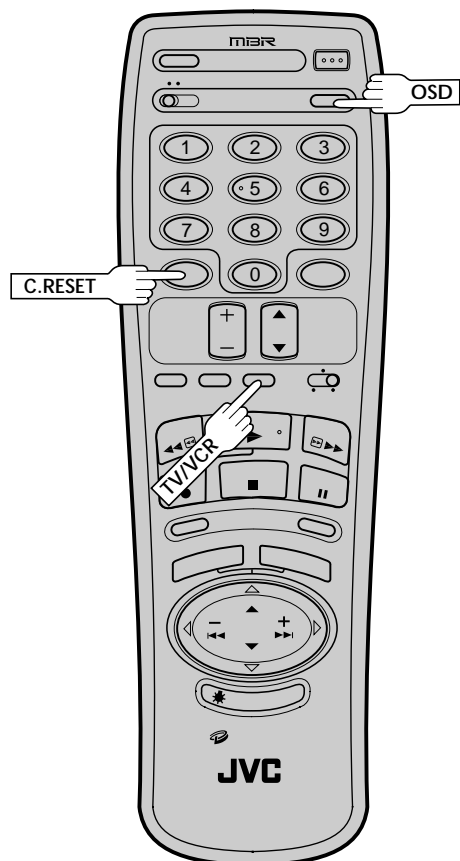

Record One Program While Watching Another

1 ENGAGE TV MODE

During recording...

- Press **TV/VCR**. The VCR's VCR indicator goes out. (If you are using the RF connection (pg. 6) to view the output from your VCR, the TV broadcast being recorded disappears.)
- If you are using the AV connection (pg. 6), to view the output from your VCR, change the TV's input mode from AV to TV.

2 SELECT CHANNEL FOR VIEWING

Use the TV's channel selector to set the channel you want to watch.

Display Elapsed Recording Time

1 RESET COUNTER TO ZERO

Before recording starts, press **C.RESET**. The counter resets to zero and displays the exact elapsed time as the tape runs.

2 DISPLAY ELAPSED TIME ON SCREEN

During recording, press **OSD** at any time to see the elapsed time. All indications corresponding to the current status of the VCR are displayed for 5 seconds. The counter display remains on the screen indicating the elapsed time. Press **OSD** again to remove the display.

- Make sure "SUPERIMPOSE" is set to "ON" (pg. 28).
- The indications are not be recorded.

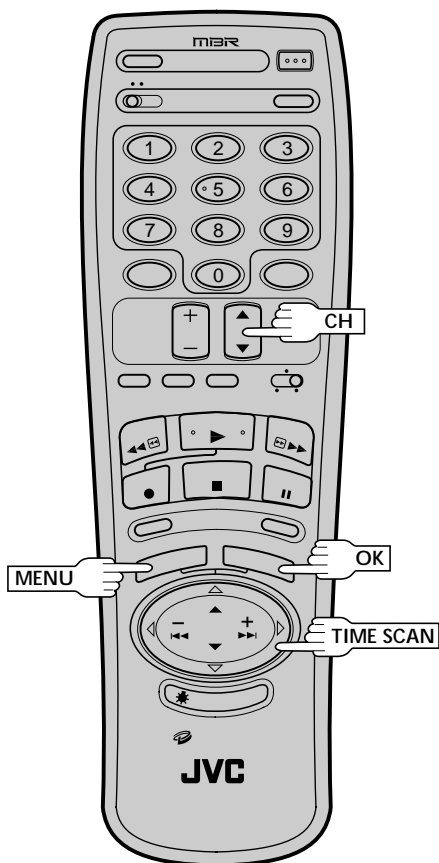
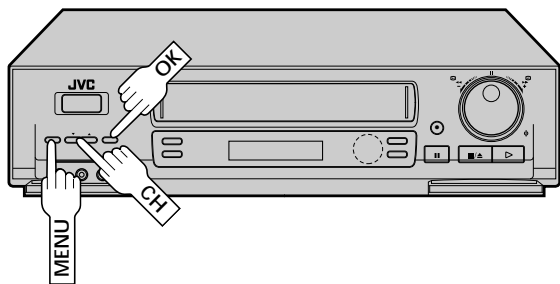

Stereo And SAP (Second Audio Program)

Your VCR's built-in MTS decoder enables reception of Multi-channel TV Sound broadcasts.

- The ST indicator on the front display panel lights during stereo broadcast reception, and SAP lights during SAP program reception.
- Both indicators light when a stereo program is accompanied by SAP audio.

To Record Stereo Programs . . .
 . . . simply follow the basic recording procedure.

To Listen To Stereo Soundtrack During Recording . . .
 . . . select "HI-FI" at the Audio Monitor screen (pg. 29).

To Record SAP Programs . . .

ACCESS MAIN MENU SCREEN

1 Press **MENU** as many times as necessary.

ACCESS FUNCTION SET SCREEN

2 Move the highlight bar (arrow) to "FUNCTION SET" by pressing **CH▲▼** or **TIME SCAN▲▼**, then press **OK**.

ACCESS AUDIO SELECT SCREEN

3 Move the highlight bar (arrow) to "AUDIO SELECT" by pressing **CH▲▼** or **TIME SCAN▲▼**, then press **OK**.

ACCESS 2ND AUDIO SCREEN

4 Move the highlight bar (arrow) to "2ND AUDIO" by pressing **CH▲▼** or **TIME SCAN▲▼**, then press **OK**.

SELECT MODE

5 Move the highlight bar (arrow) to "ON" by pressing **CH▲▼** or **TIME SCAN▲▼**.

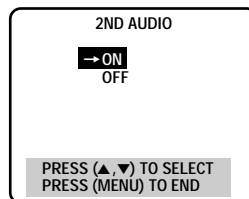

RETURN TO NORMAL SCREEN

6 Press **MENU** as many times as necessary.

NOTES:

- If a SAP program is received, the SAP audio is recorded on both the Normal and Hi-Fi tracks. The main audio program is not recorded.
- If a non-SAP program is received, the main audio is recorded on both the Hi-Fi and Normal audio tracks.

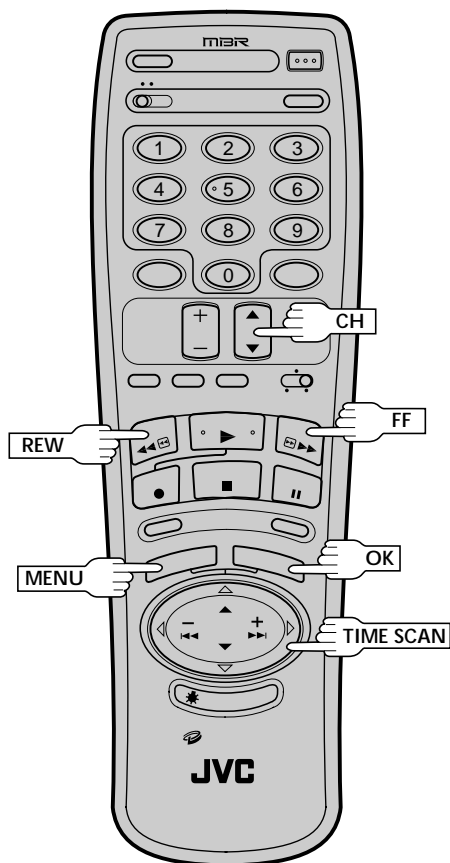
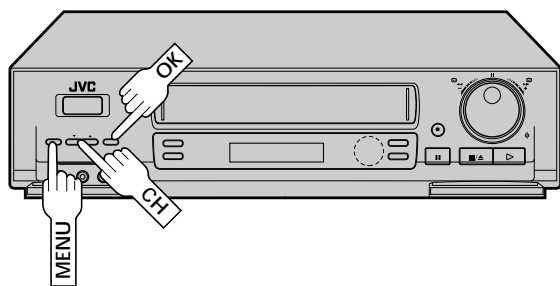

Hi-Fi Audio Recording Level Control

Your VCR allows manual adjustment of the Hi-Fi audio recording level. Normally the preset audio recording level is satisfactory, but if the sound you are going to record is too loud or too low, adjust the audio recording level while referring to the VCR's audio level meters.

1 ACCESS MAIN MENU SCREEN

Press **MENU** as many times as necessary.

2 ACCESS FUNCTION SET SCREEN

Press **CH▲▼** or **TIME SCAN▲▼** to move the highlight bar (arrow) to "FUNCTION SET", then press **OK**.

3 ACCESS AUDIO SELECT SCREEN

Move the highlight bar (arrow) to "AUDIO SELECT" by pressing **CH▲▼** or **TIME SCAN▲▼**, then press **OK**.

4 ACCESS HI-FI REC LEVEL SCREEN

Press **CH▲▼** or **TIME SCAN▲▼** to move the highlight bar (arrow) to "HI-FI REC LEVEL", then press **OK**.

5 SELECT MODE

Move the highlight bar (arrow) to "MANUAL" by pressing **CH▲▼** or **TIME SCAN▲▼**.

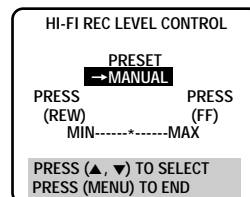

6 ADJUST AUDIO RECORDING LEVEL

Press **FF** or **REW**.

- Press **FF** or **REW** briefly 5 times to move the on-screen's audio levels by one division on the scale. To move the audio levels faster, keep **FF** or **REW** pressed.
- Adjust the recording level while watching the VCR's audio level meters. Set the level so that maximum volume causes the meters to vary between 0dB to 4dB.

7 RETURN TO NORMAL SCREEN

Press **MENU** as many times as necessary to exit.

NOTE:

Noise will increase if the recording level is too low, while distortion will increase if the level is too high.

VCR Plus+ Timer Programming

- Before VCR Plus+ Timer programming, see "VCR Plus+ Setup" on page 18.
- Turn on the TV and select the VCR channel 3 or 4 (or AV mode).

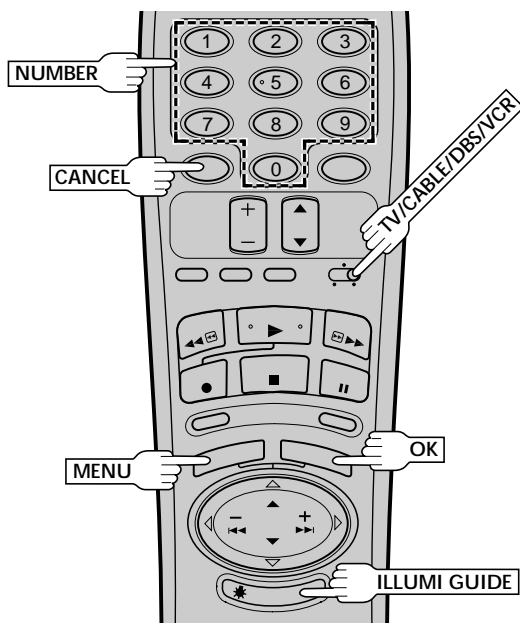
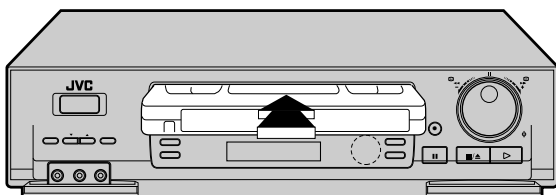

When Using The Illumi-Guide Feature

- Buttons light or blink on the remote control for approximately 10 seconds. If the button or buttons extinguish during timer programming, press **ILLUMI GUIDE** and the button or buttons previously lit or blinking come back on. If the button or buttons do not re-light or start blinking again, press **MENU** as many times as necessary to return to the normal screen and extinguish all illuminated buttons, and re-perform the timer programming procedure from the beginning.
- If for some reason the remote control's signal is not received by the VCR, press **MENU** as many times as necessary to return to the normal screen and extinguish all illuminated buttons, and re-perform the timer programming procedure from the beginning.

Timer recording allows you to program the VCR to automatically record a program which will be broadcast at some future time.

The timer record function can be programmed using VCR Plus+ or On-Screen Timer Programming. (☞ pg. 42 or 44)

During VCR Plus+ and on-screen programming, the Illumi-Guide feature tells you which button on the remote control must be pressed next by lighting the relevant buttons. The Illumi-Guide feature is activated by the **ILLUMI GUIDE** button on the remote control. The Illumi-Guide feature is only active when the remote control's **TV/CABLE/DBS/VCR** switch is set to "VCR". (Illumi-Guide is an optional help feature which makes programming easier. It is not necessary to use Illumi-Guide to program the VCR.)

1 LOAD A CASSETTE

Make sure the record safety tab is present.

- The VCR's power comes on automatically.

2 ACCESS VCR PLUS+ SCREEN

To use the Illumi-Guide feature press **ILLUMI GUIDE**. The **MENU**, **REW**, **PLAY** and **FF** buttons will light. Press **MENU** on the remote control.

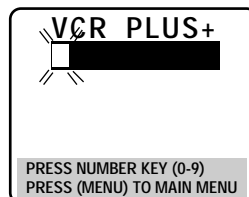

- The clock must be set in order to access the VCR Plus+ screen. If you haven't set the clock, the Main Menu screen appears when you press **MENU**. Refer to page 7 for the Plug & Play procedure or page 9 for the clock setting procedure.
- If you are using the Illumi-Guide feature, the following buttons will light up: **NUMBER** keys (0 - 9), **CANCEL** and **MENU**.

3 ENTER PLUSCODE NUMBER

Press the appropriate **NUMBER** keys to enter the PlusCode number printed in the TV listings for the TV program you wish to record.

- To make corrections, press **CANCEL** and input the correct PlusCode number.
- If the PlusCode number you input is incorrect, "ERROR" may appear on the screen to advise you of the error. This happens when the PlusCode number is for a program which has already passed. "ERROR" is displayed for about 4 seconds and the VCR Plus+ screen reappears (step 2).
- If you are using the Illumi-Guide feature, **OK** blinks when the following buttons are lit: **NUMBER** keys (0 - 9), **CANCEL** and **MENU**.

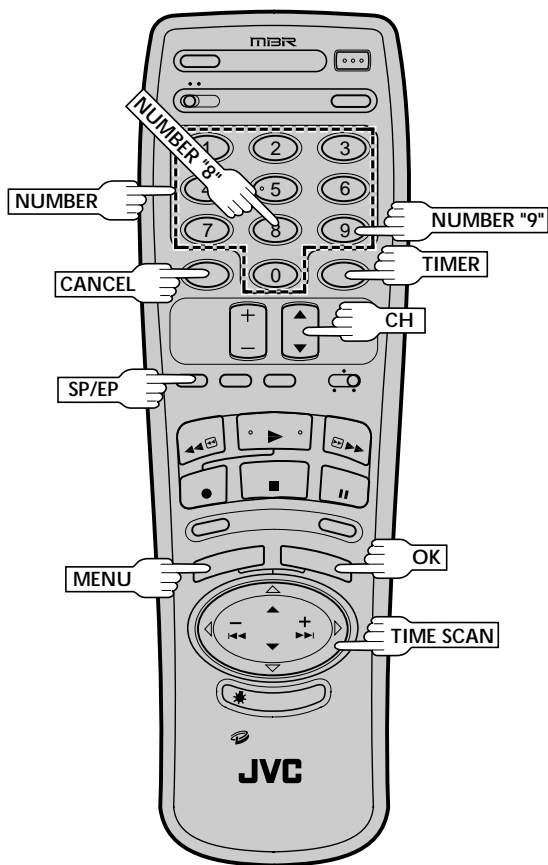

4

CHECK INPUT DATA

Press **OK** and the Program screen appears.

The PlusCode number you entered and the matching Timer-Recording information is displayed on the Program screen. Check to make sure it's accurate.

PROGRAM 1	
(VCR PLUS+ 12345678)	
DATE	12/24 WED
START	12:00 PM
STOP	1:00 PM
CHANNEL	40 SP
PRESS (8=DAILY, 9=WEEKLY SP/EP=REC SPEED) PRESS (MENU) TO END	

- To timer-record daily or weekly serials, press **DAILY** (NUMBER "8") or **WEEKLY** (NUMBER "9"). "DAILY" or "WEEKLY" appears on the Program screen. Pressing the button again makes each corresponding display disappear.
- If you made a mistake, press **CANCEL** and, after pressing **MENU** as many times as necessary to access the VCR Plus+ screen, input the correct PlusCode number.
- If you are using the Illumi-Guide feature, **MENU** lights up for about 10 seconds.

SET TAPE SPEED

Press **SP/EP**.

5

CHECK/CORRECT INPUT DATA

If the data is correct as it is, go to step 7. If not, press **OK** or **TIME SCAN** **◀▶▶▶** until the item you want to change begins to blink. Then press the appropriate **NUMBER** keys, **CH** **▲▼** or **TIME SCAN** **▲▼** to obtain the desired setting.

6

- If you are using a DBS receiver, the BAND indication (TV or CATV or DBS) appears at right of the channel number display when **OK** or **TIME SCAN** **◀▶▶▶** is pressed. See "ATTENTION FOR DBS RECEIVER USERS" on page 45.

RETURN TO NORMAL SCREEN

Press **MENU** as many times as necessary.

7

- Press just once to access the Auto Timer screen (☞ pg. 47).

ENGAGE TIMER MODE

Press **TIMER**. The VCR turns off automatically.

8

NOTES:

- To disengage the timer before recording starts, press **TIMER** again. Pressing once more re-engages it.
- In case of a power failure after programming, the VCR's memory backup keeps your selections for approximately 10 minutes.
- When timer-recording cable channels received through a Cable Box, be sure to keep the Cable Box set to ON.

On-Screen Timer Programming

Turn on the TV and select the VCR channel 3 or 4 (or AV mode).

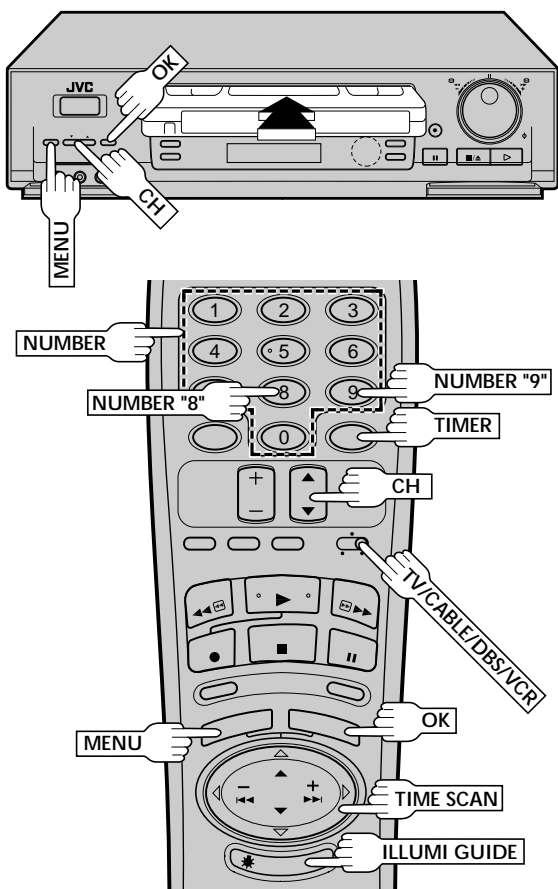

When Using The Illumi-Guide Feature

- Buttons light or blink on the remote control for approximately 10 seconds. If the button or buttons extinguish during timer programming, press **ILLUMI GUIDE** and the button or buttons previously lit or blinking come back on. If the button or buttons do not re-light or start blinking again, press **MENU** as many times as necessary to return to the normal screen and extinguish all illuminated buttons, and re-perform the timer programming procedure from the beginning.
- If for some reason the remote control's signal is not received by the VCR, press **MENU** as many times as necessary to return to the normal screen and extinguish all illuminated buttons, and re-perform the timer programming procedure from the beginning.

You can directly program the VCR's timer to record up to 8 shows, as far as a year in advance. Remember, the clock must be set before you can program the timer (pg. 7 or 9). You can also use the optional Illumi-Guide feature, where the relevant buttons on the remote control light to tell you which button to press next. The Illumi-Guide feature is activated by the **ILLUMI GUIDE** button on the remote control. The Illumi-Guide feature is only active when the remote control's **TV/CABLE/DBS/VCR** switch is set to "VCR". (Illumi-Guide is an optional help feature which makes programming easier. It is not necessary to use Illumi-Guide to program the VCR.)

1 LOAD A CASSETTE

Make sure the record safety tab is intact. If not, cover the hole with adhesive tape, then load it into the VCR.

- The VCR comes on, and the counter is reset, automatically.

2 ACCESS ON-SCREEN MENU

To use the Illumi-Guide feature press **ILLUMI GUIDE**. The **MENU**, **REW**, **PLAY** and **FF** buttons will light. Press **MENU** as many times as necessary to bring up the Main Menu screen.

- If you are using the Illumi-Guide feature, **MENU** lights up and **OK** blinks.

3 ACCESS PROGRAM SET SCREEN

Make sure the highlight bar (arrow) is on "PROGRAM SET", then press **OK**.

- If you are using the Illumi-Guide feature, **OK** blinks when the following buttons are lit: **NUMBER** keys (0 - 9), **TIME SCAN**, **CANCEL** and **MENU**.

4 SELECT PROGRAM NUMBER

Press the appropriate **NUMBER** keys or **CH▲▼** or **TIME SCAN▲▼** to select a vacant program number, then press **OK**. The first time you set the timer programming function, all the program numbers will be blank; in this case just press **OK** when the Program Set screen appears.

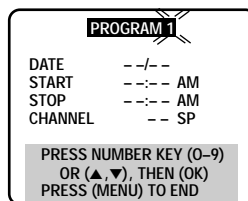

- If you are using the Illumi-Guide feature, **OK** blinks when the following buttons are lit: **NUMBER** keys (0 - 9), **TIME SCAN**, **CANCEL** and **MENU**.

5

SET PROGRAM INFORMATION

Press the appropriate **NUMBER** keys to set the date, start/stop time and channel number. Press **CH▲▼** or **TIME SCAN▲▼** to set AM/PM and tape speed (SP or EP). Press **OK** after AM/PM, channel number and tape speed settings.

* If you are using a DBS receiver, see "ATTENTION FOR DBS RECEIVER USERS" in the right column.

- Any information comprised of 1 digit (except the channel number) should have a "0" entered before it.
- It is possible to set all information using the **CH▲▼** or **TIME SCAN▲▼** button.
(In this case, press **OK** after each setting.) Do not use the **CH ▼** or **TIME SCAN▼** button to set the date.
- At the Program Set screen, the setting that can be set blinks. When setting of a highlighted item is completed, the highlight bar moves down by 1 line to the next item.
- If you are using the Illumi-Guide feature, **OK** blinks when the following buttons are lit: **NUMBER** keys (0 - 9), **TIME SCAN**, **CANCEL** and **MENU**.

** You can record selected programs at the same time every weekday, or once a week. Before entering the month, press **NUMBER** key "8" (DAILY) or "9" (WEEKLY). Either "DAILY" or "WEEKLY" appears. Press again and "DAILY" or "WEEKLY" disappears. For weekly recording, the desired date for the day of the week must be entered.

6

MAKE CORRECTIONS

To change any of the settings, press **OK** or **TIME SCAN** **◀▶** until the item you want to change begins blinking. Then set as in step 5.

- If you are using the Illumi-Guide feature, **OK** blinks when the following buttons are lit: **NUMBER** keys (0 - 9), **TIME SCAN**, **CANCEL** and **MENU**.

7

RETURN TO NORMAL SCREEN

Press **MENU** as many times as necessary.

- Press just once to access the Auto Timer screen (☞ pg. 47).
- If you are using the Illumi-Guide feature, all buttons go out.

8

ENGAGE TIMER MODE

Press **TIMER**. The VCR turns off automatically.

EXAMPLE

If you program the VCR to timer record a show on December 24 on channel 40 from 12:00 noon to 1:00 PM in SP mode, the screen will look like this:

PROGRAM 1	
DATE	12/24 WED
START	12:00 PM
STOP	1:00 PM
CHANNEL	40 SP
PRESS NUMBER KEY (0-9) OR (▲, ▼), THEN (OK) PRESS (MENU) TO END	

ATTENTION FOR DBS RECEIVER USERS

If you are using a DBS receiver (unless "DBS RECEIVER OUTPUT" is set to "OFF" ☞ pg.21), the BAND indication (TV or CATV or DBS) appears to the right of the channel number display. If the channel number that has been entered requires that the band be set, the BAND indication starts blinking:

PROGRAM 1	
DATE	12/24 WED
START	12:00 PM
STOP	1:00 PM
CHANNEL	110 DBS SP
PRESS NUMBER KEY (0-9) OR (▲, ▼), THEN (OK) PRESS (MENU) TO END	

- a- TV : To timer-record a regular TV program received on the VCR.
- b- CATV : To timer-record a cable TV program received on the VCR, or through a cable box (unless "CABLE BOX OUTPUT" is set to "OFF" ☞ pg.16).
- c- DBS : To timer-record a satellite program received through a DBS receiver.

Press **CH▲▼** or **TIME SCAN▲▼** to select the appropriate band, then press **OK**.

- If "BAND" is set to "TV" at the Band screen (☞ pg.13), CATV will not be displayed on the Program screen; if it is set to "CATV", TV will not be displayed.

NOTES:

- To disengage the timer before recording starts, press **TIMER** again. Pressing once more re-engages it.
- In case of a power failure after programming, the VCR's memory backup keeps your selections for approximately 10 minutes.
- If you select "PROGRAM SET" without having set the date and time, an error message appears. Follow its instructions.
- If you enter a start time that has already passed, "ERROR" appears on the screen and blinks.
- Programs that start after midnight must have the next day's date.
- After timer recording is completed, the VCR's power goes off automatically.
- You can program the timer while a regular recording is in progress; the on-screen menu will not be recorded.
- If the end of tape is reached during timer recording, the cassette is automatically ejected.
- When timer-recording cable or satellite channels through an external tuner, be sure to keep the cable box or satellite receiver's power ON.

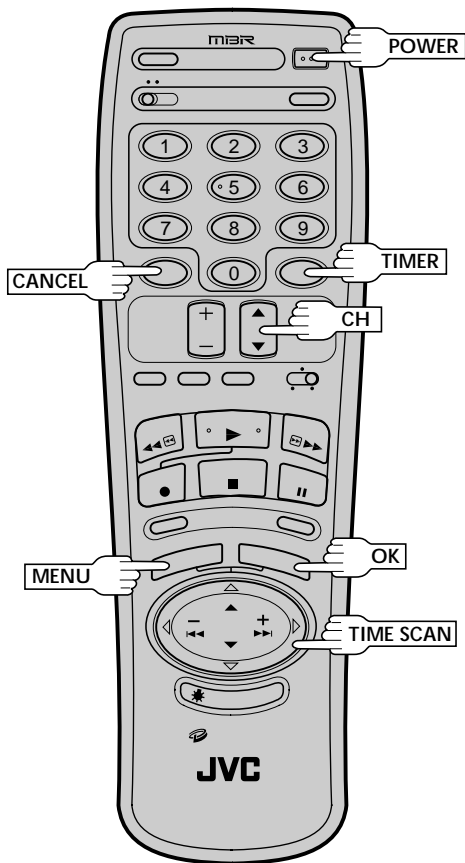
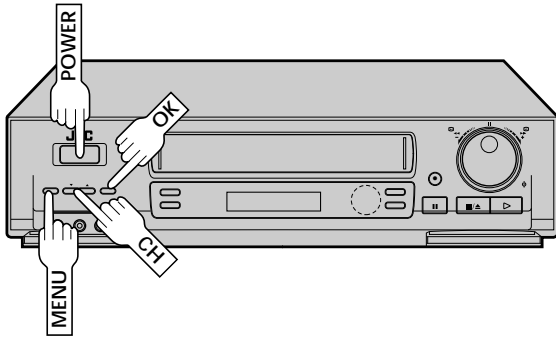

Check And Cancel Programs

1

DISENGAGE TIMER

Press **TIMER**, then press **POWER**.

2

ACCESS MAIN MENU SCREEN

Press **MENU** as many times as necessary.

3

ACCESS PROGRAM SET SCREEN

Press **CH▲▼** or **TIME SCAN▲▼** to move the highlight bar (arrow) to "PROGRAM SET", then press **OK**.

4

CHECK PROGRAM INFORMATION

Press **CH▲▼** or **TIME SCAN▲▼** to check the programs in succession.

To Cancel A Program . . .

5

CANCEL A PROGRAM

Press **CANCEL**.

- Repeat steps 4 and 5 as many times as necessary.

6

RETURN TO NORMAL SCREEN

Press **MENU** as many times as necessary. If there are still programs remaining, go to step 7.

7

RE-ENGAGE TIMER

Press **TIMER** again.

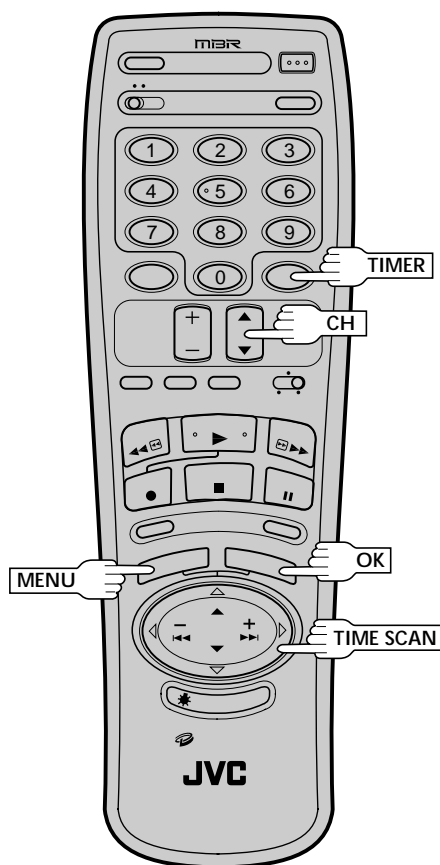
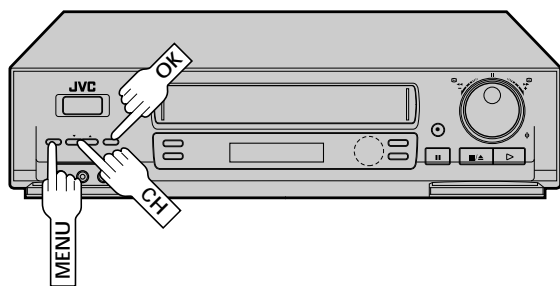

Auto Timer

When the Auto Timer is set to ON the timer is automatically engaged when the VCR's power is turned off and automatically disengaged when the VCR is powered back on.

1

ACCESS MAIN MENU SCREEN

Press **MENU** as many times as necessary.

2

ACCESS FUNCTION SET SCREEN

Move the highlight bar (arrow) to "FUNCTION SET" by pressing **CH▲▼** or **TIME SCAN▲▼**, then press **OK**.

3

ACCESS AUTO TIMER SCREEN

Move the highlight bar (arrow) to "AUTO TIMER" by pressing **CH▲▼** or **TIME SCAN▲▼**, then press **OK**. Now skip to step 2 of the procedure below.

Or, during on-screen timer programming ...

1

ACCESS AUTO TIMER SCREEN

In step 7 in the VCR Plus+ Timer Programming (pg. 42) or On-Screen Timer Programming procedure (pg. 44), press **MENU**.

2

SELECT MODE

Move the highlight bar (arrow) to your choice ("ON" or "OFF") by pressing **CH▲▼** or **TIME SCAN▲▼**.

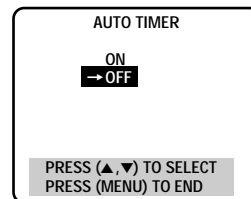

3

RETURN TO NORMAL SCREEN

Press **MENU** as many times as necessary.

NOTE:

For safety, when **AUTO TIMER** is set to "OFF", all other VCR functions are disabled while the Timer mode is engaged. To disengage the timer, press **TIMER**.

Instant Timer Recording (ITR)

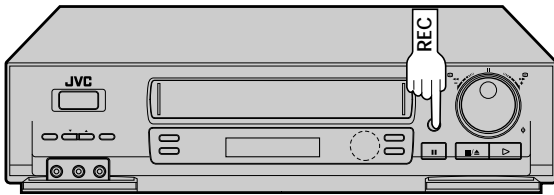

This easy method lets you record for from 30 minutes to 6 hours (selectable in 30-min. increments), and shuts the VCR off after recording is finished.

1 START RECORDING

Press **REC** on the front panel.

2 ENGAGE ITR MODE

Press **REC** again. REC blinks and 0:30 appears on the front display panel.

3 SET RECORDING DURATION

If you want to record for more than 30 minutes, press **REC** to extend the time. Each press extends recording time by 30 minutes.

NOTES:

- You can only perform ITR using the **REC** button on the VCR's front panel.
- After you set the ITR time, the previous display reappears.
- To check the remaining time, press **REC** once during recording and the remaining time will be displayed for about 5 seconds. Be careful not to press **REC** again within these 5 seconds, or you will round the recording time up to the next 30 minute increment.

Edit To Or From Another VCR

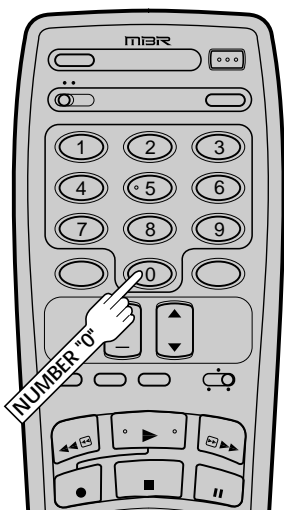
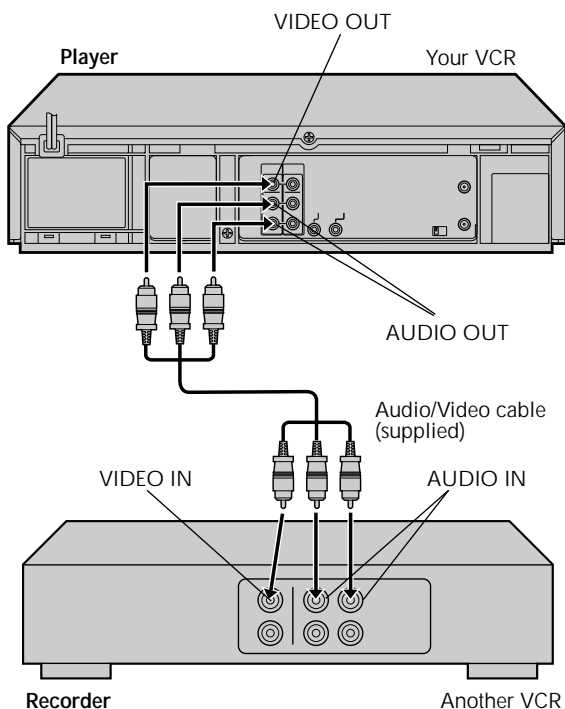

You can use your VCR as the player or the recorder.

1 MAKE CONNECTIONS

Connect an AV cable between the player's VIDEO OUT and AUDIO OUT connectors and the recorder's VIDEO IN and AUDIO IN connectors.

- When using your VCR as the recorder and a monaural VCR as the player, connect the player's AUDIO OUT connector to the AUDIO IN L connector on the recorder.

2 LOAD CASSETTES

Insert the playback cassette into the player and the cassette to be recorded on into the recorder.

3 SET RECORDER'S INPUT MODE

Set to AUX. With this VCR, press **NUMBER** key "0" (AU appears on the front display panel in place of a channel number).

NOTE:

When using this VCR as the recorder, make sure to select "FRONT" or "REAR" (depending on which input connectors you use) at the Aux Input Screen. (To select the correct AUX input connector, follow steps 4, 5, 9 - 11 from the "Edit From A Camcorder" section, pg. 50.)

4 START PLAYER

Set to its play mode.

NOTE:

If the player is equipped with a superimpose/OSD disable feature then set "SUPERIMPOSE" to OFF before pressing **PLAY** (pg. 28).

5 START RECORDER

Set to its record mode.

NOTE:

If you use an auxiliary input to connect a cable box or DBS receiver make sure that the correct input ("FRONT" or "REAR") is selected after you have finished editing (step 10, page 51).

Edit From A Camcorder

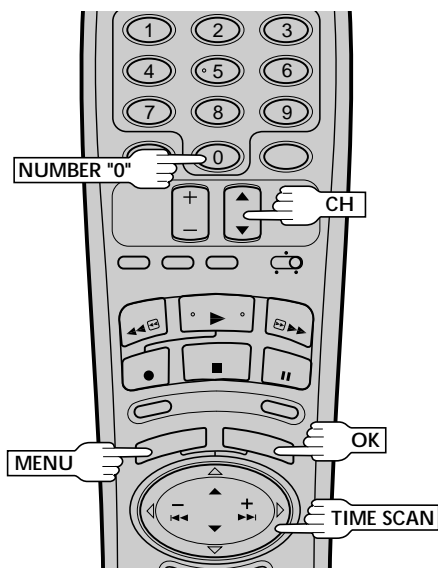
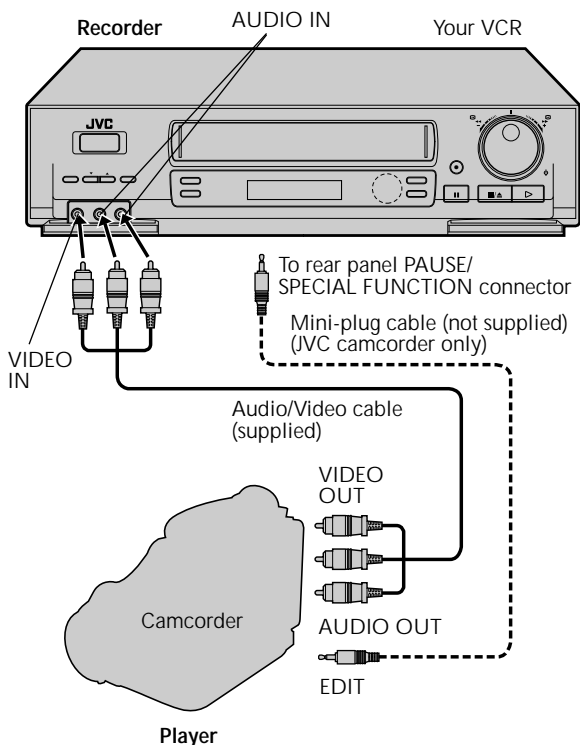

You can use a camcorder as the player and your VCR as the recorder.

1 MAKE CONNECTIONS

Connect an AV cable between the camcorder's VIDEO OUT and AUDIO OUT connectors and your VCR's VIDEO IN and AUDIO IN connectors.

- When a Master Edit Control-equipped JVC camcorder is used, the camcorder is capable of controlling your VCR. The mini-plug cable is a mono 3.5 mm mini-plug to mono 3.5 mm mini-plug connector.
- If connecting to a camcorder with a monaural output, connect the audio output connector on the camcorder to AUDIO IN L of the VCR.

2 LOAD A CASSETTE

Insert the cassette to be recorded on into the recorder.

3 SET RECORDER'S INPUT MODE

Press **NUMBER** key "0" to set to AUX.

4 ACCESS MAIN MENU SCREEN

Press **MENU** as many times as necessary.

5 ACCESS FUNCTION SET SCREEN

Press **CH**▲▼ or **TIME SCAN**▲▼ to move the highlight bar (arrow) to "FUNCTION SET", then press **OK**.

If you're using a JVC Master Edit Control-equipped camcorder — step 6

If not — step 9

6 ACCESS SPECIAL FUNCTION SCREEN

Press **CH**▲▼ or **TIME SCAN**▲▼ to move the highlight bar (arrow) to "SPECIAL FUNCTION", then press **OK**.

7 SELECT MODE

Press **CH**▲▼ or **TIME SCAN**▲▼ to move the highlight bar (arrow) to "PAUSE".

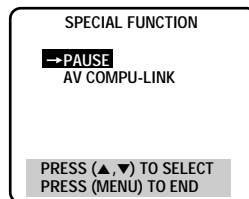

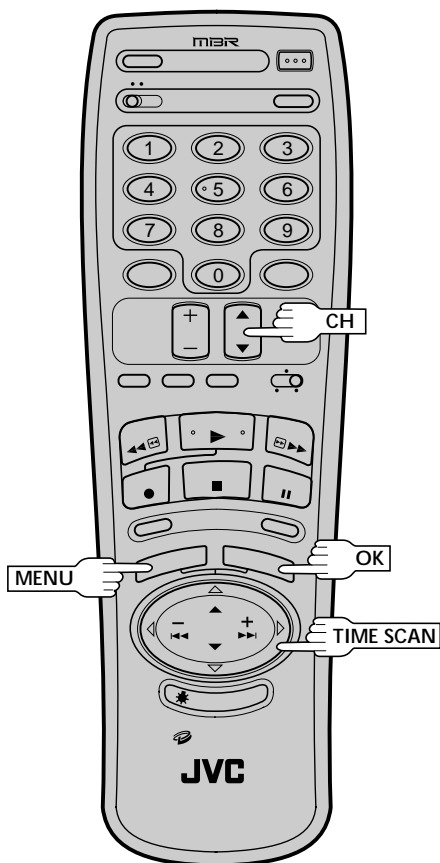
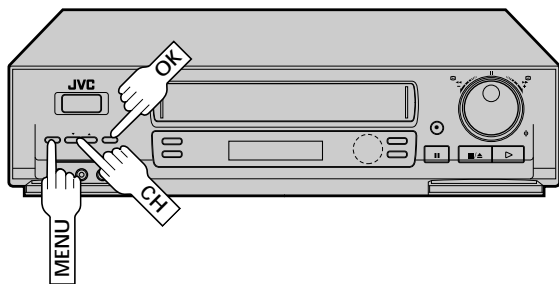

8

RETURN TO FUNCTION SET SCREEN

Press **MENU**.

9

ACCESS AUX INPUT SCREEN

Press **CH▲▼** or **TIME SCAN▲▼** to move the highlight bar (arrow) to "AUX INPUT", then press **OK**.

10

SELECT INPUT

If you are connecting the AV cable to the AV connectors on the front of the VCR, move the highlight bar (arrow) to "FRONT" by pressing **CH▲▼** or **TIME SCAN▲▼**.

If you are connecting the AV cable to the AV connectors on the back of the VCR, move the highlight bar (arrow) to "REAR" by pressing **CH▲▼** or **TIME SCAN▲▼**.

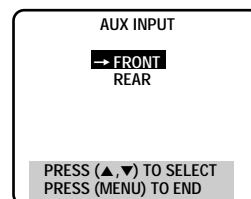

11

RETURN TO NORMAL SCREEN

Press **MENU** as many times as necessary.

12

START PLAYER

Set the camcorder to its play mode.

NOTE:

If the camcorder is equipped with a superimpose/OSD disable feature then set its superimpose or display feature to OFF before pressing play.

13

START RECORDER

Set your VCR to its record mode.

- If you are using a Master Edit Control-equipped JVC camcorder, it can put the recorder automatically into Record mode. (Refer to camcorder's instruction manual.)

NOTE:

If you use an auxiliary input to connect a cable box or DBS receiver make sure that the correct input ("FRONT" or "REAR") is selected after you have finished editing (step 10).

Insert Editing

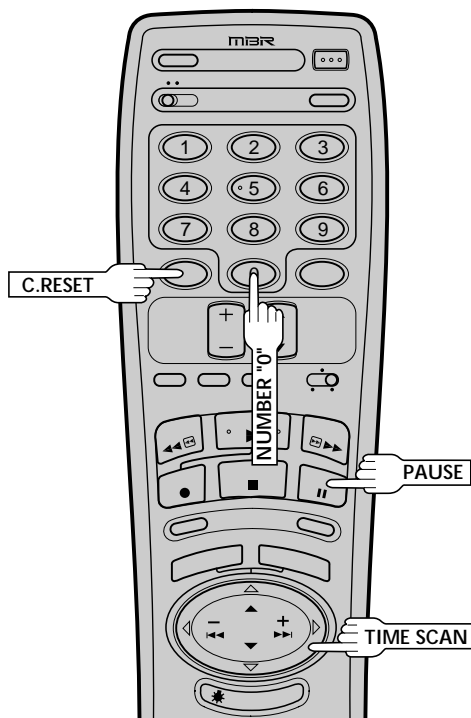
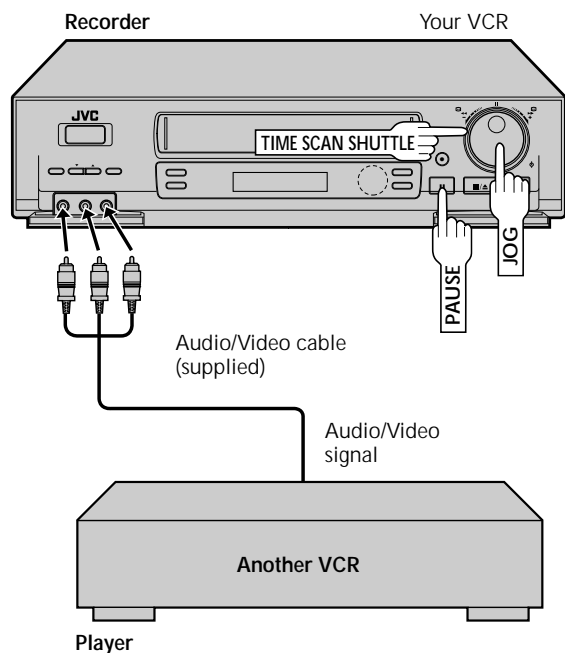

Insert editing replaces part of the recorded scene with new material. Both the picture and Hi-Fi audio soundtrack are replaced with new ones, while the normal audio soundtrack remains unchanged. If you wish to change the normal audio track as well, use the audio dubbing function simultaneously. Use your VCR as the recorder.

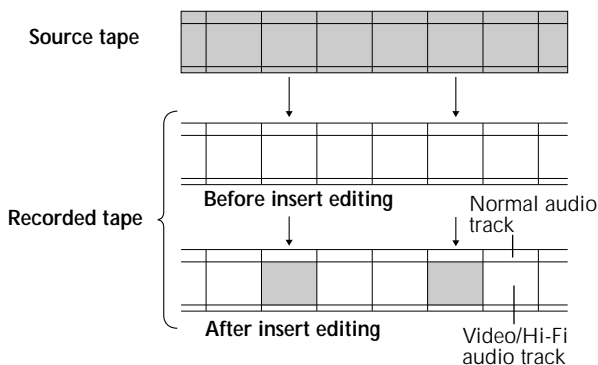

1 MAKE CONNECTIONS

Connect the player's VIDEO OUT and AUDIO OUT connectors to your VCR's VIDEO IN and AUDIO IN on the front panel.

2 SET INPUT MODE

Press **NUMBER** key "0". "AU" appears in place of a channel number.

- Be sure to select the correct AUX input connector at the Aux Input screen. (To select the correct AUX input connector, follow steps 4, 5, 9 – 11 from the "Edit From A Camcorder" section pg. 50).

3 LOCATE END POINT

Load the recording cassette into your VCR, and play it back to determine the edit-out point (the end of the segment to be replaced) using the **JOG/TIME SCAN SHUTTLE** controls or **TIME SCAN** **◀◀▶▶** and **PAUSE**.

4 RESET THE COUNTER

Press **C.RESET** to change the counter display to "0h00m00s".

5 LOCATE START POINT

Determine the edit-in point (the beginning of the segment to be replaced) using the **JOG/TIME SCAN SHUTTLE** controls or **TIME SCAN** **◀◀▶▶** and **PAUSE**.

- Be sure to engage the Still mode at the edit-in point.

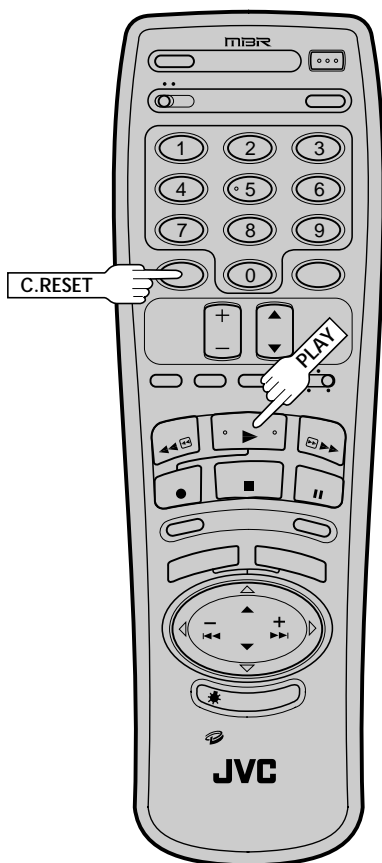
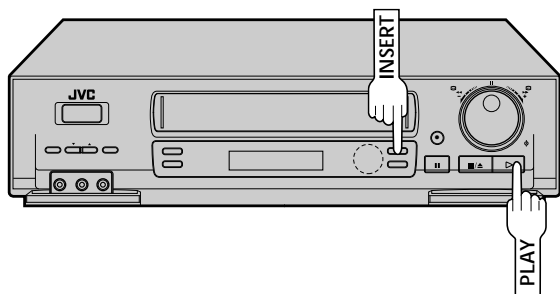

6

ENGAGE INSERT EDITING

Press **INSERT**.

- Your VCR enters the Insert-Pause mode. (REC, PLAY and PAUSE light up on the front display panel.)
- The TV screen changes from the still picture to the input source you are going to record.

7

START EDITING

Load the source cassette and play back the segment that is to be inserted. When you reach the start of the section of the source tape that you wish to insert, press **PLAY** to start the tape in your VCR; Insert Editing begins at this point.

- PLAY and REC are displayed on the front display panel.

8

END INSERT EDITING

At counter "0:00:00s", Insert Editing will stop automatically and both tapes will continue running in the Play mode. If you wish to stop Insert Editing before the specified edit-out point, press **C.RESET**.

FOR AV INSERT EDITING

If you want to replace the picture, Hi-Fi audio soundtrack and normal audio soundtrack all at the same time... In step 6 above, after you press **INSERT**, press **A.DUB.** also. (REC and PLAY blink and PAUSE lights up on the display panel.)

NOTES:

- Insert editing is not possible with cassettes whose safety tab has been removed.
- In insert editing, the recording speed (SP/EP) is determined by the previous recording to be replaced. If the previous recording's speed changes within a single edit, the inserted picture will be distorted at the switching point.
- A small portion of the recording which precedes an insert edit may become erased.
- Insert Editing is also possible using the rear connectors. When using these connectors, be sure to select the correct AUX input connector at the Aux Input screen. To select the correct AUX input connector, follow steps 4, 5, 9 - 11 from the "Edit From A Camcorder" section, pg. 50.

Audio Dubbing

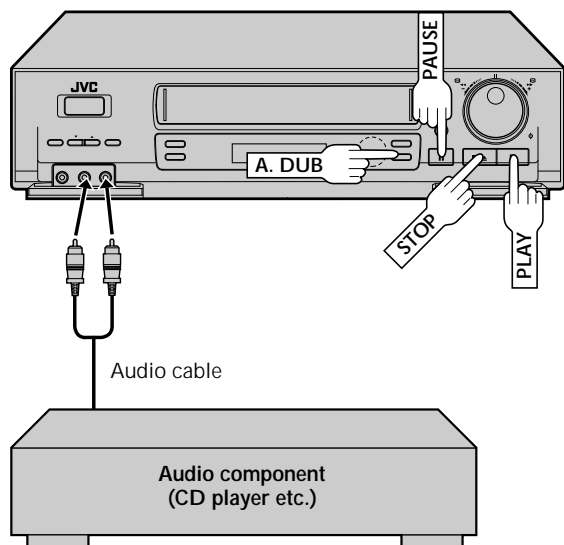

Audio dubbing replaces the normal audio sound of a previously recorded tape with a new soundtrack. Use your VCR as the recorder.

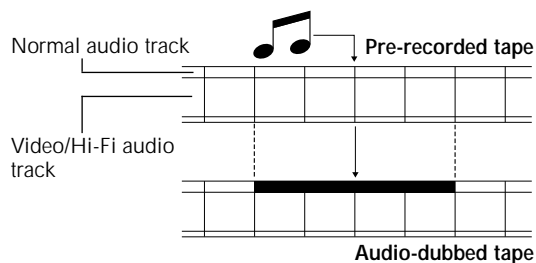

NOTES:

- When monitoring the sound during Audio Dubbing, the normal soundtrack is automatically selected. If you wish to hear the Hi-Fi or mixed sound (Hi-Fi + Normal soundtracks), refer to the "Select The Soundtrack" section (pg. 29) and select the soundtrack you wish to hear.
- Audio dubbing stops automatically when the counter reaches "0:00M00s", and the VCR enters the Play mode. Check the counter reading before dubbing.
- Audio dubbing is also possible using the rear AUDIO IN connectors. When using these connectors, be sure to select the correct AUX input connector at the Aux Input screen. To select the correct Aux Input connector, follow steps 4, 5, 9 – 11 from the "Edit From A Camcorder" section (pg. 50).
- Audio dubbing cannot be performed on a cassette that has had its record safety tab removed.
- When playing back an audio-dubbed tape, refer to the "Select The Soundtrack" section (pg. 29) to select the soundtrack you wish to hear.
- Picture may be distorted during Audio Dubbing Pause.
- It may be unlawful to record or play back copyrighted material without the consent of the copyright owner.

1 MAKE CONNECTIONS

Connect an audio component to the AUDIO IN L + R connectors on the VCR's front panel. *When connecting monaural equipment, use only the VCR's AUDIO IN L connector.

2 SET INPUT MODE

Press **NUMBER** key "0" on the remote control. "AU" appears in place of a channel number.

- Be sure to select the correct AUX input connector at the AUX Input Screen. (To select the correct AUX input connector, follow steps 4, 5, 9 – 11 from the "Edit From A Camcorder" section, pg. 50.)

3 LOCATE START POINT

Press **PLAY** to start playback of the tape in your VCR, and press **PAUSE** when you find the point where you want to start dubbing.

4 ENGAGE AUDIO DUBBING

Press **A. DUB**.

- Your VCR enters the Audio Dubbing Pause mode. (REC blinks, PLAY and PAUSE light up on the front display panel.)

5 START DUBBING

Engage the audio source component's Play mode, then press **PLAY** to start the tape in your VCR. Audio dubbing begins at this point.

- REC blinks and PLAY is displayed on the front display panel.
- To stop dubbing temporarily, press **PAUSE**. Press **PLAY** to resume dubbing.

6 END AUDIO DUBBING

Press **STOP** to stop the tape in your VCR, and engage the audio component's Stop mode.

TV Multi-Brand Remote Control

The VCR's remote control can control several functions on JVC remote control TVs and on the brands of remote control TVs listed below.

The TV brand code is factory preset to control JVC TVs.

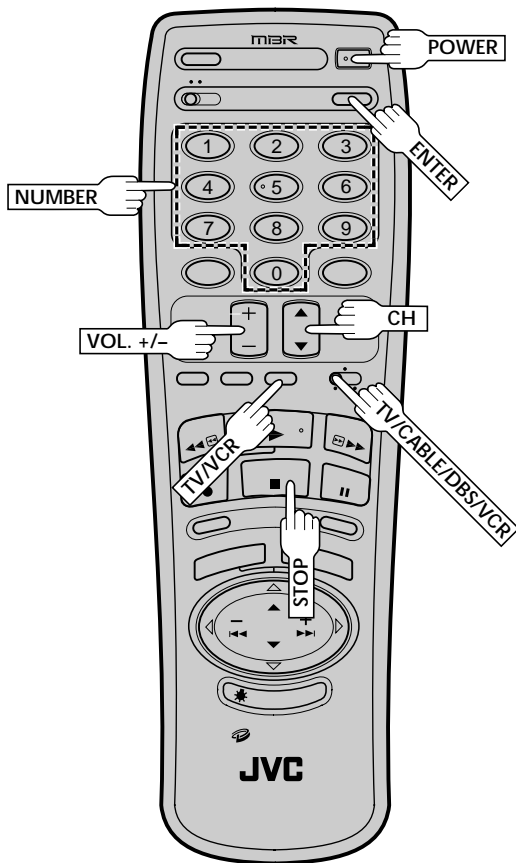

1 TURN ON THE TV

Turn the power on using the TV's remote control.

2 SET REMOTE CONTROL MODE

Set the TV/CABLE/DBS/VCR switch on the VCR's remote control to TV.

3 SET TV BRAND CODE

Refer to the chart below. While holding down **POWER** on the VCR's remote control, enter your TV's brand code using the **NUMBER** keys, then press **STOP**. Follow the example shown at bottom left.

- Once you have set the remote control to operate the TV, you don't have to repeat this step until you replace your remote control's batteries.
- PANASONIC has two codes. If the TV does not function with one code, try entering the other.

4 OPERATE TV

First, press **POWER** on the remote to see if the TV's power goes off as it should. If it does, try other operations.

- The **POWER**, **TV/VCR**, **CH▲▼**, **VOL +/-** and **NUMBER** keys on the remote can all be used to operate the TV. *For some brands of TV, you must press **ENTER** after having pressed the **NUMBER** keys.
- To return the remote to VCR control, set the **TV/CABLE/DBS/VCR** switch to VCR.

NOTE:

Depending on the kind of TV, there may be cases where some or all functions cannot be operated using the remote control.

TV BRAND NAME	BRAND CODE
JVC	01
MAGNAVOX	02
MITSUBISHI	03
PANASONIC	04, 11
RCA	05
SHARP	06
SONY	07
TOSHIBA	08
ZENITH	09
HITACHI	10
SAMSUNG	12
SANYO	13
SEARS	13

(Ex.) To set remote control to RCA 05:

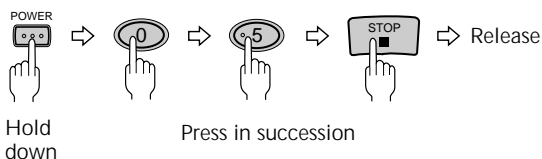

Cable Box Multi-Brand Remote Control

The VCR's remote control can control functions on the brands of cable boxes listed below. Some cable box brands have more than one code. If your cable box does not function with a specified code, try other codes.

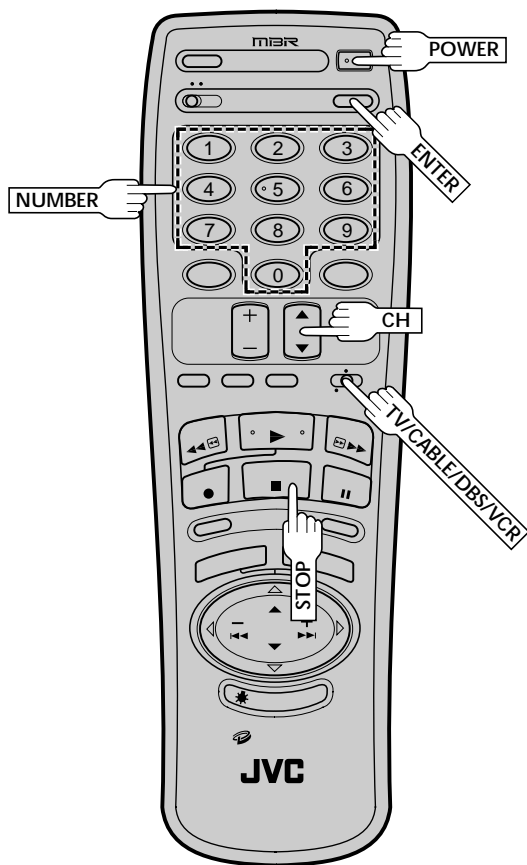

1 TURN ON THE CABLE BOX

Turn the power on using the cable box's remote control.

2 SET REMOTE CONTROL MODE

Set the TV/CABLE/DBS/VCR switch on the VCR's remote control to CABLE/DBS.

3 ENTER CABLE BOX BRAND

While holding down **POWER** on the VCR's remote control, use the **NUMBER** keys to enter the cable box brand number from the chart at bottom left and then press **STOP**.

Follow the example shown below.

- Once you have set the remote control to operate the cable box, you don't have to repeat this step until you replace the remote control's batteries.

4 OPERATE CABLE BOX

First, press **POWER** to see if the cable box's power goes off as it should. If it does, try other functions (**CH▲▼** and the **NUMBER** keys can be used to operate the cable box).

- For some brands of cable box, you must press **ENTER** after having pressed the **NUMBER** keys.
- To return the remote to VCR control, set the TV/CABLE/DBS/VCR switch to VCR.

NOTES:

- You must set the cable box brand for your remote control and the cable box brand for your Controller (pg. 17) separately. The list of cable box brands that can be controlled by your remote control is different from the list of brands that can be controlled by your controller.
- It is possible that the remote control will not operate your cable box even if the cable box's channels automatically change during timer recording using the Controller.
- It's not possible to set the remote control for both your cable box and a DBS receiver at the same time. You can only set the remote control to operate one of these units at a time.

(Ex.) To set remote control to OAK 19:

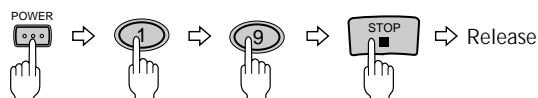

Hold down

Press in succession

CABLE BOX BRAND NAME	BRAND CODE
CURTIS	09, 10
GEMINI	08
GENERAL INSTRUMENTS	01, 02, 03, 04, 05, 06, 07, 08
HAMLIN	15, 16, 17, 18
JERROLD	01, 02, 03, 04, 05, 06, 07, 08
OAK	19, 20, 21
PIONEER	13, 14
REGAL	15, 16, 17, 18
SAMSUNG	08, 13
SCIENTIFIC ATLANTA	09, 10
SIGMA	19, 20, 21
SL MARX	08, 13
TELEVIEW	08, 13
VIDEOWAY	11, 12
ZENITH	11, 12

DBS Receiver Multi-Brand Remote Control

The VCR's remote control can control functions on the brands of DBS (Direct Broadcast Satellite) receivers listed below.

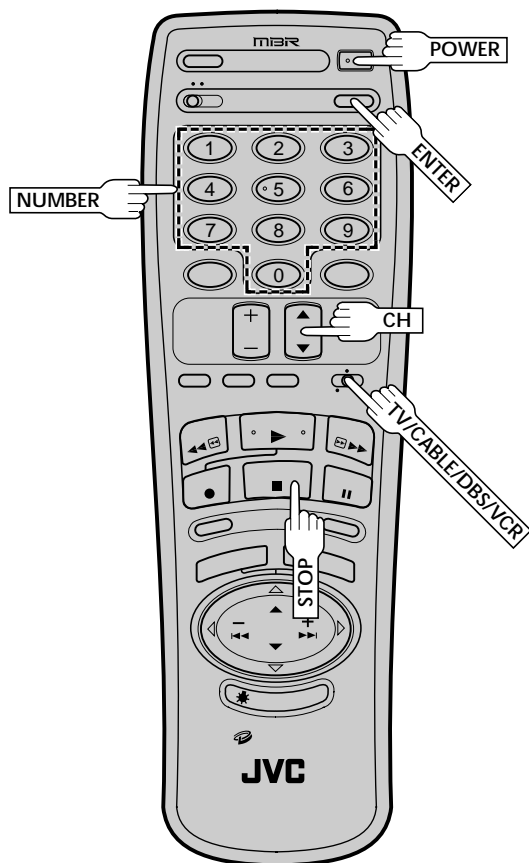

1 TURN ON THE DBS RECEIVER

Turn the power on using the DBS receiver's remote control.

2 SET REMOTE CONTROL MODE

Set the **TV/CABLE/DBS/VCR** switch on the VCR's remote control to **CABLE/DBS**.

3 ENTER DBS RECEIVER BRAND

While holding down **POWER** on the VCR's remote control, use the **NUMBER** keys to enter the DBS receiver brand number from the chart below and then press **STOP**. Follow the example shown at bottom left.

- Once you have set the remote control to operate the DBS receiver, you don't have to repeat this step until you replace the remote control's batteries.

4 OPERATE DBS RECEIVER

First, press **POWER** to see if the DBS receiver's power goes off as it should. If it does, try other functions (**CH▲▼** and the **NUMBER** keys can be used to operate the DBS receiver).

- For some brands of DBS receiver, you must press **ENTER** after having pressed the **NUMBER** keys.
- To return the remote to VCR control, set the **TV/CABLE/DBS/VCR** switch to **VCR**.

NOTES:

- You must set the DBS receiver brand for your remote control and the DBS receiver brand for your Controller (see pg. 22) separately.
- It is possible that the remote control will not operate your DBS receiver even if the DBS receiver's channels automatically change during timer recording using the Controller.
- Though ECHOSTAR has a number of different remote codes, this remote control is applicable only to one of those codes preset at the factory.
- It's not possible to set the remote control for both your DBS receiver and a cable box at the same time. You can only set the remote control to operate one of these units at a time.

(Ex.) To set remote control to RCA 80:

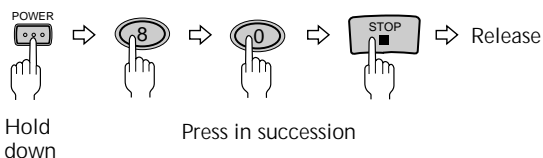

DBS BRAND NAME	BRAND CODE
RCA (DSS)	80
SONY (DSS)	81
PRIMESTAR	90
ECHOSTAR	91

Control Two JVC VCRs

The supplied remote control is capable of controlling two JVC VCRs independently using the **A/B CODE** switch. You can set this VCR so it responds to remote commands only when the switch is set to **B**, and another VCR so it responds to commands when the switch is set to **A**. The switch is preset to **A** because this VCR normally responds to A-code signals. Follow steps 1 – 4 to set this VCR to respond to B-code commands.

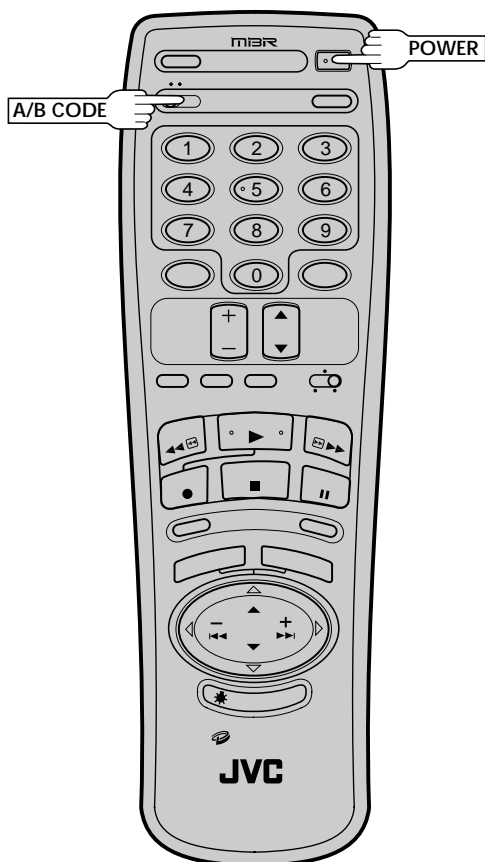

1 UNPLUG VCR'S POWER CORD

Unplug from the AC outlet.

2 SET A/B CODE SWITCH

Set the **A/B CODE** switch on the remote control to **B**.

3 PLUG IN POWER CORD

Plug back in to the AC outlet.

4 TURN VCR POWER ON

Press **POWER** on the remote.

The VCR will now respond only to B-code commands. To set the VCR to respond to A code signals again, repeat the above procedures setting the **A/B CODE** switch to **A**, instead of **B**, in step 2. You can control two VCRs with the same remote control by switching the remote's code between A and B.

Before requesting service for a problem, use this chart and see if you can repair the trouble yourself. Small problems are often easily corrected, and this can save you the trouble of sending your VCR off for repair.



POWER		
SYMPTOM	POSSIBLE CAUSE	CORRECTIVE ACTION
1. The power won't come on.	<ul style="list-style-type: none"> • The power cord is disconnected. 	Connect the power cord.
2. The clock works, but the VCR's power won't come on.	<ul style="list-style-type: none"> • The TIMER mode is engaged with Auto Timer set to "OFF" (☞ pg. 47). 	Press TIMER to disengage.
3. The remote control won't function.	<ul style="list-style-type: none"> • The batteries are discharged. • The A/B CODE switch is in the wrong position. • The TV/CABLE/DBS/VCR switch is in the wrong position. 	Replace the dead batteries with new ones. Re-perform the A/B Code setting (☞ pg. 58). Set the switch to the position corresponding with the unit you want to operate.
TAPE TRANSPORT		
SYMPTOM	POSSIBLE CAUSE	CORRECTIVE ACTION
1. The cassette gets stuck partway during loading, and is ejected.	<ul style="list-style-type: none"> • The cassette was inserted incorrectly. 	Make sure the cassette's window is facing up, the rear label side is facing you and the arrow on the front of the cassette is pointing towards the VCR. Then insert the cassette
2. The tape stops during rewind or fast forward.	<ul style="list-style-type: none"> • The Counter Memory indicator ("M") is lit on the front display panel. 	Press C.MEMORY to disengage the Counter Memory mode and extinguish the indicator (☞ pg. 31).
PLAYBACK		
SYMPTOM	POSSIBLE CAUSE	CORRECTIVE ACTION
1. The tape is running but the picture won't appear.	<ul style="list-style-type: none"> • If you're using the RF OUT connection (☞ pg. 6), the channel selector on the TV is set incorrectly. • If you're using the AV connection (☞ pg. 6), the TV receiver is set to the wrong mode. 	Set the channel selector to channel 3 or 4. Set the TV receiver to its AV mode.
2. Breaks are noticeable in Hi-Fi soundtrack.	<ul style="list-style-type: none"> • Automatic tracking is engaged. 	Disengage Auto Tracking and adjust the tracking manually (☞ pg. 26).
3. The playback picture is blurred or interrupted, even though TV broadcasts are clear.	<ul style="list-style-type: none"> • The video heads may be dirty. 	The heads must be cleaned. Consult your JVC dealer.
4. The Hi-Fi soundtrack cannot be heard.	<ul style="list-style-type: none"> • The AUDIO MONITOR option at the Audio Select screen was set incorrectly. 	Set AUDIO MONITOR to "HI-FI" (☞ pg. 29).

CONTINUED ON NEXT PAGE.

RECORDING

SYMPTOM	POSSIBLE CAUSE	CORRECTIVE ACTION
1. Recording won't start.	<ul style="list-style-type: none"> There's no cassette loaded. The loaded cassette has had its record safety tab removed. 	<p>Insert a cassette.</p> <p>Remove the cassette and cover the hole with adhesive tape, or load a cassette on which the record safety tab is intact.</p>
2. TV broadcasts won't record properly.	<ul style="list-style-type: none"> The VCR has been set to its AUX mode by mistake. 	<p>Set the VCR to the appropriate channel.</p>
3. Tape-to-tape editing won't work.	<ul style="list-style-type: none"> The VCRs or the camcorder and the VCR have been incorrectly connected. The power to one or more of the units has not been turned on. The recorder's input mode has been set incorrectly. 	<p>Refer to the directions and the illustration under "Edit To Or From Another VCR" (☞ pg. 49) or "Edit From A Camcorder" (☞ pg. 50) and properly connect the units.</p> <p>Make sure the power to all units is on.</p> <p>Select the recorder's appropriate input mode at the Aux Input Screen (☞ pg. 51).</p>

TIMER RECORDING

SYMPTOM	POSSIBLE CAUSE	CORRECTIVE ACTION
1. Timer recording won't work.	<ul style="list-style-type: none"> The clock and/or the timer have been set incorrectly. The timer is not engaged. The VCR has not been set up properly. 	<p>Set the clock and/or timer correctly.</p> <p>Press TIMER and check to make sure that TIMER appears on the front display panel.</p> <p>Re-perform the set-up procedures. Make sure you have compensated for Guide Channel and VCR or cable box channel number mismatches (☞ pg. 18).</p>
2. On-screen timer programming won't work.	<ul style="list-style-type: none"> Timer recording is in progress. 	<p>Timer programming can't be performed when timer recording is in progress. Wait until it finishes.</p>
3. TIMER and  on the front display panel won't stop blinking.	<ul style="list-style-type: none"> The timer is engaged but there's no cassette loaded. 	<p>Load a cassette with the record safety tab intact, or with the hole covered with adhesive tape.</p>
4. The cassette is automatically ejected, and TIMER and  on the front display panel won't stop blinking.	<ul style="list-style-type: none"> The loaded cassette has had its record safety tab removed. 	<p>Remove the cassette and cover its hole with adhesive tape, or replace it with a cassette on which the safety tab is intact.</p>
5. TIMER blinks for 10 seconds and the timer mode is disengaged.	<ul style="list-style-type: none"> TIMER has been pressed when there are no programs in memory, or the timer record program information has not been programmed correctly. 	<p>Check the programmed data and re-program as necessary, then press TIMER again.</p>
6. The cassette is automatically ejected, the power shuts off and TIMER and  won't stop blinking.	<ul style="list-style-type: none"> The end of tape was reached during timer recording. 	<p>The program may not have been recorded in its entirety. Next time make sure you have enough time on the tape to record the entire program.</p>
7. Cable channels are not automatically switched during timer recording.	<ul style="list-style-type: none"> The Controller is not properly connected to the VCR. The output channel selected in the Cable Box Output screen is incorrect. The cable box's power is off. 	<p>Connect the Controller correctly (☞ pg. 15).</p> <p>After confirming your cable box's output channel number, re-access the Cable Box Output screen and select the correct number (☞ pg. 16).</p> <p>Make sure the power is on before timer recording starts.</p>

<p>8. Satellite channels are not automatically switched during timer recording.</p>	<ul style="list-style-type: none"> ● The Controller is not properly connected to the VCR. ● The output channel selected in the DBS Receiver Output screen is incorrect. ● The VCR is not set correctly to control the DBS Receiver ● The DBS receiver's power is off. 	<p>Connect the Controller correctly (☞ pg. 20). After confirming your DBS receiver's output channel number, re-access the DBS Receiver Output screen and select the correct number (☞ pg. 21). Set the correct DBS Receiver brand code (☞ pg. 22). Make sure the power is on before timer recording starts.</p>
<p>9. Timer recording begins as scheduled, but the channel is always incorrect.</p>	<ul style="list-style-type: none"> ● Even though you don't use an external Cable Box, "CABLE BOX OUTPUT" is set to "ON". 	<p>Set "CABLE BOX OUTPUT" to "OFF" (☞ pg. 16).</p>
<p>10. We moved, and now VCR Plus+ doesn't work properly.</p>	<ul style="list-style-type: none"> ● The receivable stations in the new area are received on different channels than those in the previous area. 	<p>Re-perform the VCR Plus+ setup procedure (☞ pg. 18).</p>
<p>11. "PROGRAM FULL" is displayed on the VCR Plus+ screen.</p>	<ul style="list-style-type: none"> ● All 8 programs of the VCR's timer memory are used. 	<p>Wait until a space in memory clears, or cancel unnecessary program information (☞ pg. 46).</p>

OTHER PROBLEMS

SYMPTOM	POSSIBLE CAUSE	CORRECTIVE ACTION
<p>1. When scanning channels, some of them are skipped over.</p>	<ul style="list-style-type: none"> ● Those channels have been preset to be skipped. 	<p>If you need the skipped channels, restore them (☞ pg. 14).</p>
<p>2. The channel can't be changed.</p>	<ul style="list-style-type: none"> ● Recording is in progress. 	<p>Press PAUSE to pause the recording, change channels, then press PLAY to resume recording.</p>
<p>3. The remote control won't operate my TV or cable box or DBS receiver.</p>	<ul style="list-style-type: none"> ● The TV/CABLE/DBS/VCR switch is set to the wrong position. ● The remote control brand setting is incorrect. 	<p>Set the switch to the correct position. Re-set the remote control to the correct brand (☞ pg. 55 or 56 or 57).</p>
<p>4. Even though Auto or Semi-Auto clock setting has been selected, the clock is incorrect.</p>	<ul style="list-style-type: none"> ● The clock setting data received from the Host Channel is incorrect. 	<p>Select a different Host Channel during the Semi-Auto setting procedure (☞ pg. 10), or perform the Manual setting procedure (☞ pg. 11).</p>

ATTENTION:

This VCR contains microcomputers. External electronic noise or interference can cause microcomputer to malfunction. If the VCR does not operate correctly switch its power off and unplug the power cord from the AC supply. Wait for a while and then plug the power back in. Eject and check the condition of the cassette. If everything appears normal resume operating the VCR as usual.

PLAYBACK

- Q. What happens if the end of the tape is reached during playback or search?**
A. The tape is automatically rewound to the beginning.

- Q. Can the VCR indefinitely remain in the still mode?**
A. No. It stops automatically after 5 minutes to protect the heads.

- Q. During search, still and frame-by-frame playback, the picture is intermittent. What's the cause?**
A. Picture loss occurs when these types of playback are attempted with a tape recorded in LP mode. Pressing **PLAY** to return to normal playback will restore the picture.

- Q. When returning from multi-speed search to normal playback, the picture is disturbed. Should I be concerned about this?**
A. No, it is normal.

- Q. When playing back programs that have been timer-recorded with consecutive times (such one program from 8:00 to 9:00 and another one from 9:00 to 10:00), the picture becomes momentarily distorted at the point where the first program ends and the second program begins. Is this a malfunction?**
A. No. This is normal.

- Q. Other than preventing further recording, what effect does removing the safety tab have?**
A. It disables marking of index codes.

- Q. Sometimes, during Index Search, the VCR can't find the program I want to see. Why not?**
A. There may be index codes too close together.

- Q. During playback, on-screen operational indicators sometimes jitter. Why does this happen?**
A. If the condition of the tape being played back is not good, jittering of the video (including on-screen indicators) may occur.

RECORDING

- Q. When I pause and then resume a recording, the end of the recording before the pause is overlapped by the new recording. Why does this happen?**
A. This is normal. It reduces distortion at the pause and resume points.

- Q. Can the VCR indefinitely remain in the Record-Pause mode?**
A. No. The VCR automatically goes to its Stop mode after 5 minutes to protect the heads. When paused during Instant Timer Recording (ITR), the VCR shuts off automatically after 5 minutes.

- Q. What happens if the tape runs out during recording?**
A. The VCR automatically rewinds it to the beginning.

TIMER RECORDING

- Q. REC and TIMER remain lit on the front display panel. Is there a problem?**
A. No. This is a normal condition for a timer recording in progress.

- Q. Can I program the timer while I'm watching a tape or a TV broadcast?**
A. Yes, but while you are setting the timer you won't see the tape's or broadcast program's picture as it is replaced by the on-screen menu. The audio from the tape or broadcast program will be present during the setting of the timer.

List Of Terms

This guide serves as a quick way to locate frequently used terms and on-screen display names.

A

A/B Code	58
Add Channel	14
AFC	14
Audio Dubbing	54
Audio Monitor	29
Auto Channel Setting	12
Auto Clock Setting	11
Auto Daylight Saving Time	11
Auto Picture	34
Auto Timer	47
Automatic Tracking	26
Aux Input	50
AV Compu Link Playback	32
AV Connection	6

B

Band	13
------------	----

C

Cable Box	15
Cable Box Brand Setting	17
Cable Box Controller	15
Cancel Program	46
Cassette Adapter	23
Check Program	46
Connection to TV	6
Contents	5
Counter Memory	31
Counter Reset	31

D

DBS Receiver	20
DBS Receiver Brand Setting	22
DBS Receiver Controller	20
Delete Channel	14

E

Editing	49
---------------	----

F

Frame-by-Frame Playback	25
Function Setting	28

G

Guide Channel Map	19
Guide Channel Setting	19

H

Host Channel Selection	10
------------------------------	----

I

Illumi Guide	42
Index Search	30
Insert Cassette	23
Insert Editing	52
Instant ReView	30
ITR (Instant Timer Recording)	48

L

Language Selection	8
--------------------------	---

M

Main Menu	8
Manual Channel Setting	14
Manual Clock Setting	11
Manual Tracking	26
MBR (Multi-Brand Remote) Code Setting	55

N

Next-Function Memory	31
----------------------------	----

O

On-Screen Display	28
On-Screen Timer Programming	44
On-Screen Timer Recording	44
Override Auto Clock Setting	9

P

PBS Channel	7
Playback	23
Plug & Play	7

R

Record Safety Tab	24
Recording	24
Repeat Playback	31
Reverse Motion Playback	36
Reverse Slow Motion Playback	25
RF Connection	6

S

SAP (Second Audio Program)	40
Second Audio	40
Select Cable Box Output Channel	16
Select DBS Receiver Output Channel	21
Semi-Auto Clock Setting	10
Skip Search	37
Slow Motion Playback	25
Specifications	67
Still Picture Playback	25
Superimpose	28

T

Tape Position Indicator	26
Tape Speed Setting	24
TimeScan	36
TIME SCAN SHUTTLE ring	36
Time Zone Selection	11
Tuner Setting	12

V

Variable-Speed Search	36
VCR Plus+	18
VCR Plus+ Timer Programming	42
VCR Plus+ Timer Recording	42
Video Stabilizer	27

FRONT VIEW

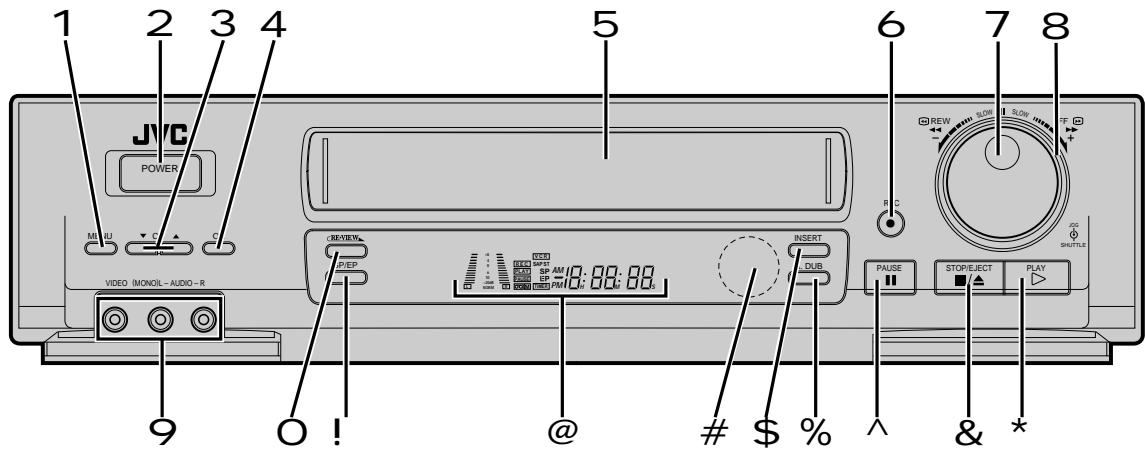

- 1 MENU Button (☞ pg. 8)
- 2 Power On/Off Button (☞ pg. 8)
- 3 Channel [CH] ▲▼ Button (☞ pg. 24)
- 4 OK Button (☞ pg. 8)
- 5 Cassette Loading Slot
- 6 Record [REC] Button (☞ pg. 24)
- 7 JOG Dial (☞ pg. 25)
- 8 TIME SCAN SHUTTLE ring (☞ pg. 36)
- 9 VIDEO/AUDIO Input Connectors (☞ pg. 50)

- O Instant REVIEW Button (☞ pg. 30)
- ! Recording Speed [SP/EP] Button (☞ pg. 24)
- @ Front Display Panel (☞ pg. 65)
- # Remote Control Sensor
- \$ INSERT Button (☞ pg. 53)
- % Audio Dubbing [A. DUB] Button (☞ pg. 54)
- ^ PAUSE Button (☞ pg. 25)
- & STOP/EJECT Button (☞ pg. 23)
- * PLAY Button (☞ pg. 23)

REAR VIEW

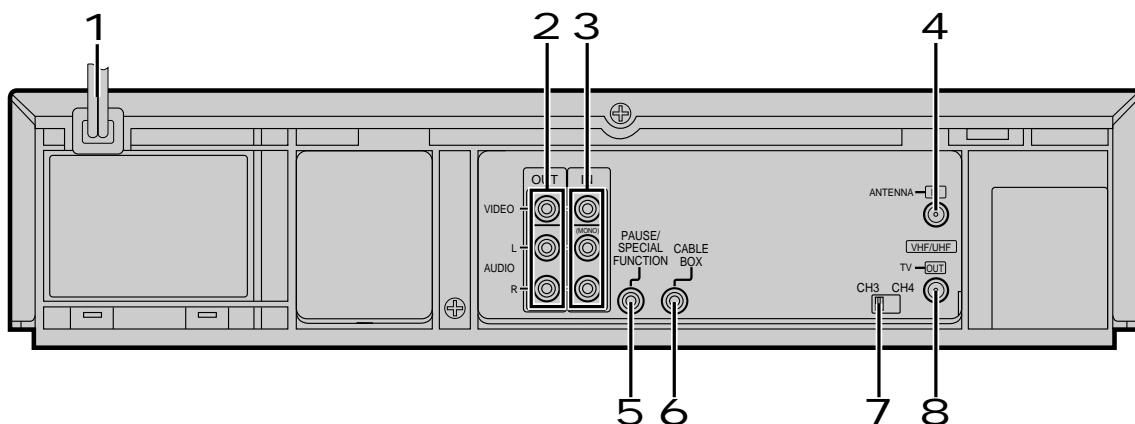

- | | |
|--|--------------------------------------|
| 1 Power Cord (☞ pg. 6) | 6 CABLE BOX Connector (☞ pg. 15, 20) |
| 2 VIDEO/AUDIO Output Connectors (☞ pg. 49) | 7 Channel 3/4 Switch (☞ pg. 6) |
| 3 VIDEO/AUDIO Input Connectors (☞ pg. 49) | 8 TV OUT Connector (☞ pg. 6) |
| 4 ANTENNA IN Connector (☞ pg. 6) | |
| 5 PAUSE/SPECIAL FUNCTION Connector | |
| • Remote PAUSE Connector (☞ pg. 50) | |
| • AV COMPU-LINK Connector (☞ pg. 32) | |

FRONT DISPLAY PANEL

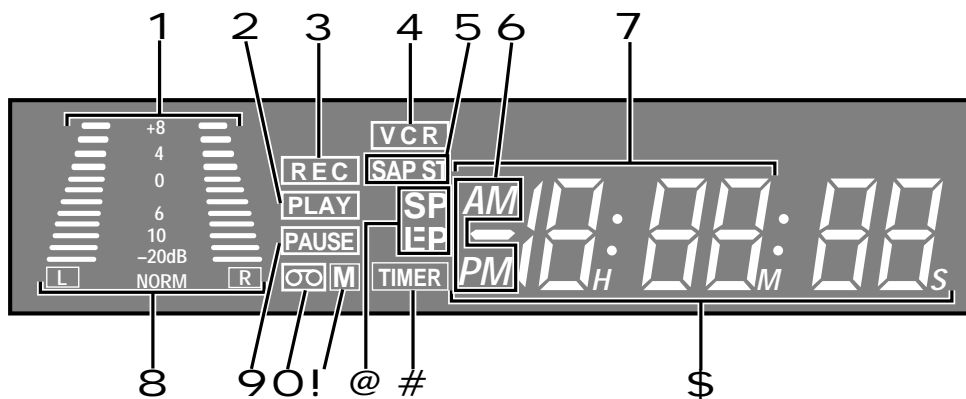

- | | |
|--|--|
| 1 Audio Level meter (☞ pg. 41) | 8 Audio Output mode indicator (☞ pg. 29) |
| 2 Play Mode Indicator | 9 Pause Mode Indicator |
| 3 Recording Mode Indicator | 0 "Cassette Loaded" Mark |
| Instant Timer Recording Indicator (☞ pg. 48) | ! Counter Memory Mark (☞ pg. 31) |
| 4 VCR Mode Indicator (☞ pg. 39) | @ Tape Speed Indicators (☞ pg. 24) |
| 5 Multi-Channel TV Sound Indicators (☞ pg. 40) | # Timer Mode Indicator |
| 6 AM/PM Indicators (☞ pg. 7) | \$ Channel Display ["AU" for AUX mode] |
| 7 Clock Display (☞ pg. 7) | Counter Display (☞ pg. 23) |

REMOTE CONTROL

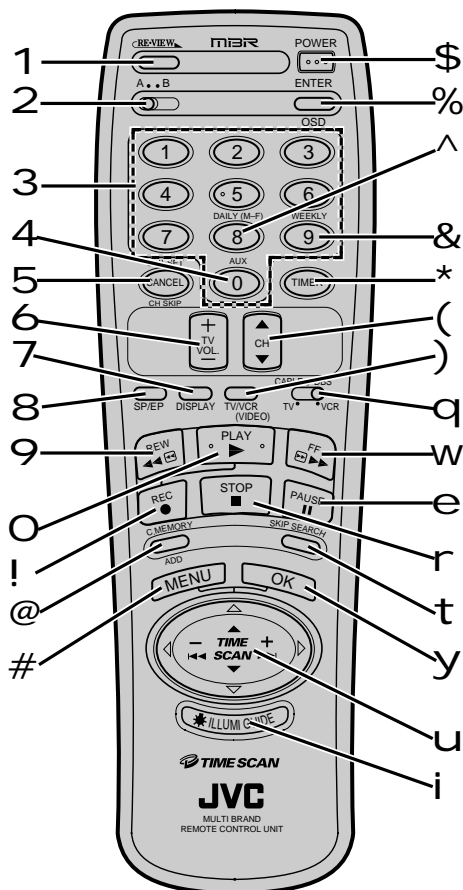

- 1 Instant REVIEW Button (☞ pg. 30)
- 2 A/B Code Select Switch (☞ pg. 58)
- 3 NUMBER Buttons (☞ pg. 24, 42)
- 4 "AUX" Mode Select Button (☞ pg. 50)
- 5 CANCEL Button (☞ pg. 46)
Counter [C.] RESET (☞ pg. 31)
Channel [CH.] SKIP Button (☞ pg. 14)
- 6 Volume [VOL] +/- Buttons (☞ pg. 55)
- 7 DISPLAY Button (☞ pg. 31)
- 8 Recording Speed [SP/EP] Button (☞ pg. 24)
- 9 Rewind [REW] Button (☞ pg. 23)
- 0 PLAY Button (☞ pg. 23)
- ! Record [REC] Button (☞ pg. 24)
- @ Counter [C.] MEMORY Button (☞ pg. 31)
ADD Button (☞ pg. 14)
- # MENU Button (☞ pg. 8)
- \$ POWER ON/OFF Button (☞ pg. 8)
- % ENTER Button (☞ pg. 24)
On-Screen Display [OSD] Button (☞ pg. 28)
- ^ DAILY Timer Recording Button (☞ pg. 43)
- & WEEKLY Timer Recording Button (☞ pg. 43)
- * TIMER Button (☞ pg. 43)
- (Channel [CH] ▲▼ Buttons (☞ pg. 24)
-) TV/VCR Button (☞ pg. 39)
- q TV/CABLE/DBS/VCR Switch (☞ pg. 55)
- w Fast-Forward [FF] Button (☞ pg. 23)
- e PAUSE Button (☞ pg. 25)
- r STOP Button (☞ pg. 23)
- t SKIP SEARCH Button (☞ pg. 37)
- y OK Button (☞ pg. 8)
- u TIME SCAN Button (☞ pg. 8, 36)
- i ILLUMI GUIDE Button (☞ pg. 42)

Installing Batteries

- 1 Open the battery compartment cover.
- 2 Insert 2 "AA"-size batteries (provided) in the direction indicated under the battery cover.
- 3 Replace the cover.

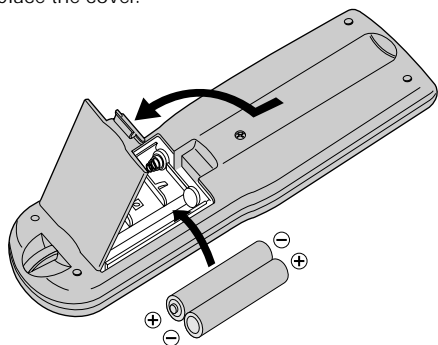

How To Use

The remote control can operate most of your VCR's functions.

- 1 Point the remote control toward the sensor window.
- 2 Press the appropriate operation button.
- 3 The maximum operating distance of the remote control is about 8 m.

NOTES:

- This remote control can also operate various brands of TVs, Cable Boxes and DBS Receivers. For instructions, ☞ pg. 55 - 57.
- If the remote control doesn't work properly, remove its batteries, wait a short time, replace the batteries and then try again.

GENERAL

Power requirement	: AC 120 V \sim , 60 Hz
Power consumption	: 21 W
Temperature	
Operating	: 5°C to 40°C (41°F to 104°F)
Storage	: -20°C to 60°C (-4°F to 140°F)
Operating position	: Horizontal only
Dimensions (W x H x D)	: 400 x 94 x 340 mm (15-3/4" x 3-3/4" x 13 -7/16")
Weight	: 4.3 kg (9.5 lbs)
Format	: VHS NTSC standard
Maximum recording time	
SP	: 210 min. with ST-210 video cassette
EP	: 630 min. with ST-210 video cassette

VIDEO/AUDIO

Signal system	: NTSC-type color signal and EIA monochrome signal, 525 lines/60 fields
Recording/ Playback system	: DA-4 (Double Azimuth) head helical scan system
Signal-to-noise ratio	: 45 dB
Horizontal resolution	: 240 lines
Frequency range	
Normal audio	: 70 Hz to 10,000 Hz
Hi-Fi audio	: 20 Hz to 20,000 Hz
Input/Output	: RCA connectors (IN x 2, OUT x 1)

TUNER

Tuning system	: Frequency-synthesized tuner
Channel coverage	
VHF	: Channels 2-13
UHF	: Channels 14-69
CATV	: 113 Channels
RF output	: Channel 3 or 4 (switchable; preset to Channel 3 when shipped) 75 ohms, unbalanced

TIMER

Clock reference	: Quartz
Program capacity	: 1-year programmable timer/8 programs
Memory backup time	: Approx. 10 min.

ACCESSORIES

Provided accessories	: RF cable (F-type), Infrared remote control unit, "AA" battery x 2, Audio/Video Cable, Controller
----------------------	--

Specifications shown are for SP mode unless otherwise specified. E. & O.E. Design and specifications subject to change without notice.

HOW TO LOCATE YOUR JVC SERVICE CENTER**TOLL FREE: 1-800-252-5722****Dear customer:**

In order to receive the most satisfaction from your purchase, read the instruction booklet before operating the unit. In the event that repair is necessary, or for the address nearest your location, please refer to the factory service center list below or within the Continental United States, call 1-800-252-5722 for your authorized servicer. Remember to retain your Bill of Sale for Warranty Service.

— JVC

**JVC SERVICE & ENGINEERING
COMPANY OF AMERICA
DIVISION OF US JVC CORP.**

FACTORY SERVICE CENTER LOCATIONS

107 Little Falls Road
Fairfield, NJ 07004-2105
(201) 808-9279

1500 Lakes Parkway
Lawrenceville, GA 30243-5857
(770) 339-2522

705 Enterprise Street
Aurora, IL 60504-8135
(630) 851-7855

5665 Corporate Avenue
Cypress, CA 90630-4727
(714) 229-8011

10700 Hammerly Boulevard, Suite 110
Houston, TX 77043-2310
(713) 935-9331

2969 Mapunapuna Place, Suite 101
Honolulu, HI 96819-2000
(808) 833-5828

230 Eliot Street
Ashland, MA 01721-2377
(508) 881-5923

8192 W State Road 84
Davie, FL 33324-4611
(954) 472-1960

890 Dubuque Avenue
South San Francisco, CA 94080-1804
(415) 871-2666

Sophisticated electronic products may require occasional service. Just as quality is a keyword in the engineering and production of the wide array of JVC products, service is the key to maintaining the high level performance for which JVC is world famous. The JVC service and engineering organization stands behind our products.

NATIONAL HEADQUARTERS
JVC SERVICE & ENGINEERING COMPANY OF AMERICA
DIVISION OF US JVC CORP.
107 Little Falls Road
Fairfield, NJ 07004-2105

If you ship the product...

Pack your JVC unit in the original carton or one of equivalent size and strength. Enclose, with the unit, a letter stating the problem or symptom that exists and also a copy of the receipt or bill of sale you received when you purchased your JVC unit. Print your home return address on the outside and the inside of the carton. Send to the appropriate JVC Factory Service Center as listed above.

Don't service it yourself.**CAUTION**

To prevent electrical shock, do not open the cabinet. No user serviceable parts inside.
Refer servicing to qualified service personnel.

ACCESSORIES

To purchase accessories for your JVC product, you may contact your local JVC Dealer.
Or from the 48 Continental United States call toll free:
1-800-882-2345.

LIMITED WARRANTY

CONSUMER VIDEO 1-90

JVC COMPANY OF AMERICA warrants this product and all parts thereof, except as set forth below **ONLY TO THE ORIGINAL PURCHASER AT RETAIL** to be **FREE FROM DEFECTIVE MATERIALS AND WORKMANSHIP** from the date of original retail purchase for the period as shown below. ("The Warranty Period")

PARTS	1 YR	LABOR	90 DAYS
-------	-------------	-------	----------------

THIS LIMITED WARRANTY IS VALID ONLY IN THE FIFTY (50) UNITED STATES, THE DISTRICT OF COLUMBIA AND IN COMMONWEALTH OF PUERTO RICO.

WHAT WE WILL DO:

If this product is found to be defective, JVC will repair or replace defective parts at no charge to the original owner. Such repair and replacement services shall be rendered by JVC during normal business hours at JVC authorized service centers. Parts used for replacement are warranted only for the remainder of the Warranty Period. All products and parts thereof may be brought to a JVC authorized service center on a carry-in basis except for Television sets having a screen size 25 inches and above which are covered on an in-home basis.

WHAT YOU MUST DO FOR WARRANTY SERVICE:

Return your product to a JVC authorized service center with a copy of your bill of sale. For your nearest JVC authorized service center, please call toll free: (800) 252-5722.

If service is not available locally, box the product carefully, preferably in the original carton, and ship, insured, with a copy of your bill of sale plus a letter of explanation of the problem to the nearest JVC Factory Service Center, the name and location of which will be given to you by the toll-free number.

If you have any questions concerning your JVC Product, please contact our Customer Relations Department.

WHAT IS NOT COVERED:

This limited warranty provided by JVC does not cover:

1. Products which have been subject to abuse, accident, alteration, modification, tampering, negligence, misuse, faulty installation, lack of reasonable care, or if repaired or serviced by anyone other than a service facility authorized by JVC to render such service, or if affixed to any attachment not provided with the products, or if the model or serial number has been altered, tampered with, defaced or removed;
2. Initial installation and installation and removal for repair;
3. Operational adjustments covered in the Owner's Manual, normal maintenance, video and audio head cleaning;
4. Damage that occurs in shipment, due to act of God, and cosmetic damage;
5. Signal reception problems and failures due to line power surge;
6. Video Pick-up Tubes/CCD Image Sensor, Cartridge, Stylus (Needle) are covered for 90 days from the date of purchase;
7. Accessories;
8. Batteries (except that Rechargeable Batteries are covered for 90 days from the date of purchase); from the date of purchase);

There are no other express warranties except as listed above.

THE DURATION OF ANY IMPLIED WARRANTIES INCLUDING THE IMPLIED WARRANTY OF MERCHANTABILITY, IS LIMITED TO THE DURATION OF THE EXPRESS WARRANTY HEREIN.

JVC SHALL NOT BE LIABLE FOR THE LOSS OF USE OF THE PRODUCT, INCONVENIENCE, LOSS OR ANY OTHER DAMAGES, WHETHER DIRECT, INCIDENTAL OR CONSEQUENTIAL (INCLUDING, WITHOUT LIMITATION, DAMAGE TO TAPES, RECORDS OR DISCS) RESULTING FROM THE USE OF THIS PRODUCT, OR ARISING OUT OF ANY BREACH OF THIS WARRANTY. ALL EXPRESS AND IMPLIED WARRANTIES, INCLUDING THE WARRANTIES OF MERCHANTABILITY AND FITNESS FOR PARTICULAR PURPOSE, ARE LIMITED TO THE WARRANTY PERIOD SET FORTH ABOVE.

Some states do not allow the exclusion of incidental or consequential damages or limitations on how long an implied warranty lasts, so these limitations or exclusions may not apply to you. This warranty gives you specific legal rights and you may also have other rights which vary from state to state.

JVC COMPANY OF AMERICA
DIVISION OF US JVC CORP.

41 Slater Drive
Elmwood Park, New Jersey 07407

REFURBISHED PRODUCTS CARRY A SEPARATE WARRANTY, THIS WARRANTY DOES NOT APPLY. FOR DETAILS OF REFURBISHED PRODUCT WARRANTY, PLEASE REFER TO THE REFURBISHED PRODUCT WARRANTY INFORMATION PACKAGED WITH EACH REFURBISHED PRODUCT.

For customer use:

Enter below the Model No. and Serial No. which is located either on the rear, bottom or side of the cabinet. Retain this information for future reference.

Model No.: _____

Serial No.: _____

Purchase date: _____

Name of dealer: _____



JVC

JVC COMPANY OF AMERICA
DIVISION OF US JVC CORP.
41 Slater Drive, Elmwood Park, N.J. 07407

JVC CANADA INC.
21 Finchdene Square, Scarborough Ontario M1X 1A7

Free Manuals Download Website

<http://myh66.com>

<http://usermanuals.us>

<http://www.somanuals.com>

<http://www.4manuals.cc>

<http://www.manual-lib.com>

<http://www.404manual.com>

<http://www.luxmanual.com>

<http://aubethermostatmanual.com>

Golf course search by state

<http://golfingnear.com>

Email search by domain

<http://emailbydomain.com>

Auto manuals search

<http://auto.somanuals.com>

TV manuals search

<http://tv.somanuals.com>