

JVC

VIDEO CASSETTE RECORDER

HR-J438E HR-J238E

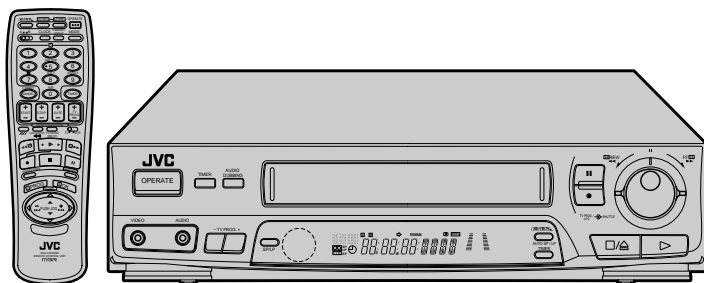

The recorder illustrations appearing in this instruction manual are of the HR-J438E.

SHOWVIEW

VHS
PAL

INSTRUCTIONS

ENGLISH

CONTENTS

SAFETY FIRST	2
Safety Precautions	2
INSTALLING YOUR NEW RECORDER	3
Basic Connections	3
Tune The TV To Your Video Recorder	3
Connecting/Using A Decoder	4
INITIAL SETTINGS	5
Tuner Set	5
Clock Set	7
PLAYBACK	9
Basic Playback	9
Playback Features	10
RECORDING	14
Basic Recording	14
B.E.S.T. Picture System	15
On-Screen Displays	17
Recording Features	18
TIMER RECORDING	19
Information On ShowView	19
Guide Prog. Number Set	19
When Using A Satellite Tuner	20
ShowView Timer Recording	21
Regular Timer Programming	23
Check And Cancel Programmes	24
Auto SP/LP Timer [J438E only]	24
PDC/VPS Recording	24
Timer Warning	24
EDITING	25
Audio Dubbing [J438E only]	25
Edit To Or From Another Video Recorder	26
Edit From A Camcorder	27
REMOTE CONTROL	28
Multi-Brand Remote Control	28
USING THE CONFIRMATION SCREEN	29
Storing Channels Manually	29
Delete A Channel	29
Change Station Channel Position	29
Set Stations	30
Fine-Tuning Channels Already Stored	30
TV STATION AND ID LIST	31
TROUBLESHOOTING	32
QUESTIONS AND ANSWERS	34
SPECIFICATIONS	35
INDEX	36

PU30425-1871-1 **EN**



Safety Precautions

The rating plate and the safety caution are on the rear of the unit.

WARNING: DANGEROUS VOLTAGE INSIDE

WARNING: TO PREVENT FIRE OR SHOCK HAZARD, DO NOT EXPOSE THIS UNIT TO RAIN OR MOISTURE.

CAUTION

- When you are not using the recorder for a long period of time, it is recommended that you disconnect the power cord from the mains outlet.
- Dangerous voltage inside. Refer internal servicing to qualified service personnel. To prevent electric shock or fire hazard, remove the power cord from the mains outlet prior to connecting or disconnecting any signal lead or aerial.

IMPORTANT

- Please read the various precautions on this page before installing or operating the recorder.
- It should be noted that it may be unlawful to re-record pre-recorded tapes, records, or discs without the consent of the owner of copyright in the sound or video recording, broadcast or cable programme and in any literary, dramatic, musical, or artistic work embodied therein.

WARNING

There are two different types of SECAM colour systems: SECAM-L, used in FRANCE (also called SECAM-West), and SECAM-B, used in Eastern European countries (also called SECAM-East).

1. This recorder can also receive SECAM-B colour television signals for recording and playback.
2. Recordings made of SECAM-B television signals produce monochrome pictures if played back on a video recorder of SECAM-L standard, or do not produce normal colour pictures if played back on a PAL video recorder with SECAM-B system incorporated (even if the TV set is SECAM-compatible).
3. SECAM-L prerecorded cassettes or recordings made with a SECAM-L video recorder produce monochrome pictures when played back with this recorder.
4. This recorder cannot be used for the SECAM-L standard. Use a SECAM-L recorder to record SECAM-L signals.

The OPERATE button does not completely shut off mains power from the unit, but switches operating current on and off.

To J438E Owners:

Video tapes recorded with this video recorder in the LP (Long Play) mode cannot be played back on a single-speed video recorder.

Failure to heed the following precautions may result in damage to the recorder, remote control or video cassette.

1. **DO NOT** place the recorder . . .

- ... in an environment prone to extreme temperatures or humidity.
- ... in direct sunlight.
- ... in a dusty environment.
- ... in an environment where strong magnetic fields are generated.
- ... on a surface that is unstable or subject to vibration.

2. **DO NOT** block the recorder's ventilation openings.

3. **DO NOT** place heavy objects on the recorder or remote control.

4. **DO NOT** place anything which might spill on top of the recorder or remote control.

5. **AVOID** violent shocks to the recorder during transport.

MOISTURE CONDENSATION

Moisture in the air will condense on the recorder when you move it from a cold place to a warm place, or under extremely humid conditions—just as water droplets form in the surface of a glass filled with cold liquid. Moisture condensation on the head drum will cause damage to the tape. In conditions where condensation may occur, keep the recorder turned on for a few hours to let the moisture dry.

ABOUT HEAD CLEANING

Accumulation of dirt and other particles on the video heads may cause the playback picture to become blurred or interrupted. Be sure to contact your nearest JVC dealer if such troubles occur.

For Italy:

"It is declared that this product, brand JVC, conforms to the Ministry Decree n. 548 of 28 Aug.'95 published in the Official Gazette of the Italian Republic n. 301 of 28 Dec.'95"



- Only cassettes marked "VHS" can be used with this videorecorder.
- HQ VHS is compatible with existing VHS equipment.
- ShowView is a trademark applied for by Gemstar Development Corporation. The ShowView system is manufactured under licence from Gemstar Development Corporation.

Basic Connections

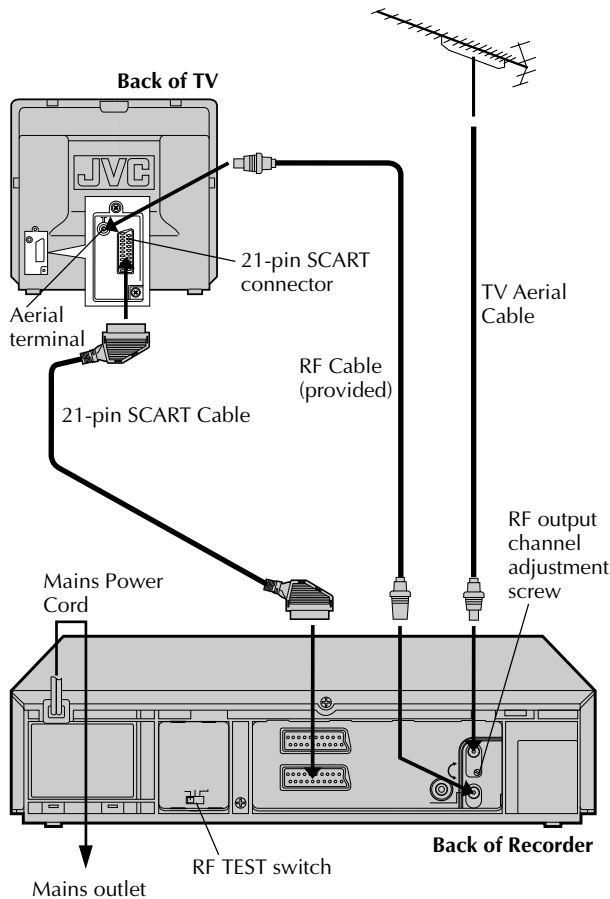

It's essential that your video recorder be properly connected. Follow these steps carefully. THESE STEPS MUST BE COMPLETED BEFORE ANY VIDEO OPERATION CAN BE PERFORMED.

- 1 CHECK CONTENTS**
Make sure the package contains all of the accessories listed in "Specifications" (pg. 35).
- 2 SITUATE RECORDER**
Place the recorder on a stable, horizontal surface.
- 3 CONNECT RECORDER TO TV**
The connection method you use depends on the type of TV you have.
RF CONNECTION
 - To Connect To A TV With NO AV Input Terminals . . .
 - a- Disconnect the TV aerial cable from the TV.
 - b- Connect the TV aerial cable to the ANT. IN jack on the rear panel of the recorder.
 - c- Connect the provided RF cable between the RF OUT jack on the rear panel of the recorder and the TV's aerial terminal.

Before operating the recorder, make sure the TV's channel is set to the VIDEO channel.

AV CONNECTION
 - To Connect To A TV With AV Input Terminals . . .
 - a- Connect the aerial, recorder and TV as per "RF CONNECTION".
 - b- Connect an optional SCART cable between the AV1 IN/OUT socket on the rear panel of the recorder and the TV's 21-pin SCART connector.
 - c- Set the RF TEST switch to OFF.

Before operating the recorder, make sure the TV is set to the VIDEO (or AV) mode.
- 4 CONNECT RECORDER TO MAINS**
Plug the end of the mains power cord into a mains outlet.

Tune The TV To Your Video Recorder

The video recorder sends picture and sound signals via the RF connecting cable to your TV on UHF channel 36.

- 1 TURN ON THE RECORDER**
Press **OPERATE**.
- 2 SELECT OUTPUT MODE**
Set the **RF TEST** switch on the back of the recorder to **ON**.

CONTINUED ON NEXT PAGE.

Connecting/ Using A Decoder

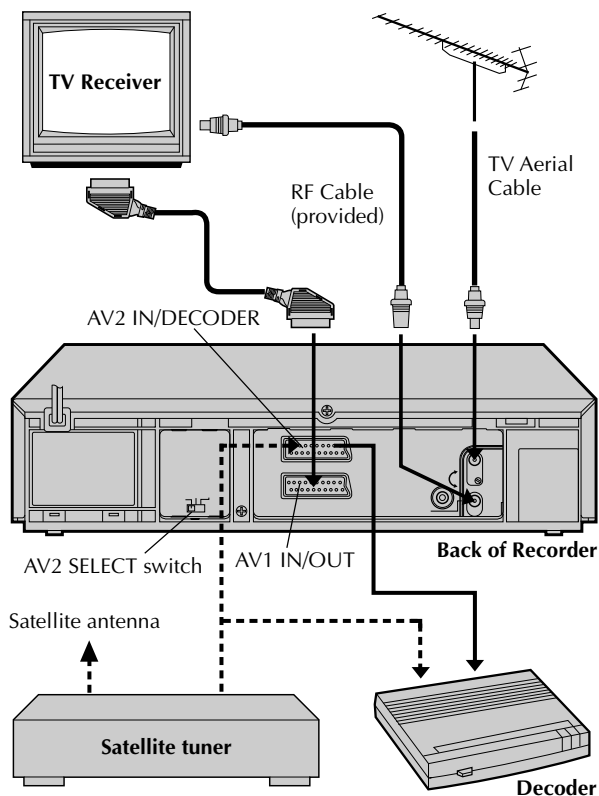

3 SET TV CHANNEL

Set your TV to the video channel (UHF channel 36). Two white bars appear on screen vertically.

- Tune the TV until the bars are as clear as they can be.
- Your TV should be set to the channel designated for use with a video recorder, or to a spare channel if there is not a specified video channel on your TV.

4 RESET OUTPUT MODE

Return the **RF TEST** switch to OFF.

NOTES:

- If CH36 is occupied by a local station, adjust the RF output channel adjustment screw to use another channel between CH32 and CH40 instead.
- If some interference noise is continually seen on the screen, consult your JVC dealer.

The AV2 IN/DECODER connector can be used as an input terminal for an external decoder (descrambler). Simply connect a decoder and you can enjoy the variety of programming that is available through scrambled channels.

1 SELECT INPUT MODE

Set the **AV2 SELECT** switch to "DECODER".

2 CONNECT DECODER

Connect your recorder's AV2 IN/DECODER connector to the decoder's Euroconnector using a 21-pin SCART cable.

3 SET TUNER

Follow the procedure starting on page 5.

NOTES:

When Connecting A Satellite Tuner . . .

- . . . connect it to the decoder, or if you don't have a decoder connect the satellite tuner directly to the video recorder.
- . . . set the **AV2 SELECT** switch to "AV2".
- . . . to view a programme via the satellite tuner, select **AU 2** mode by pressing **TV PROG.** until "AU 2" appears on the display panel.

Tuner Set

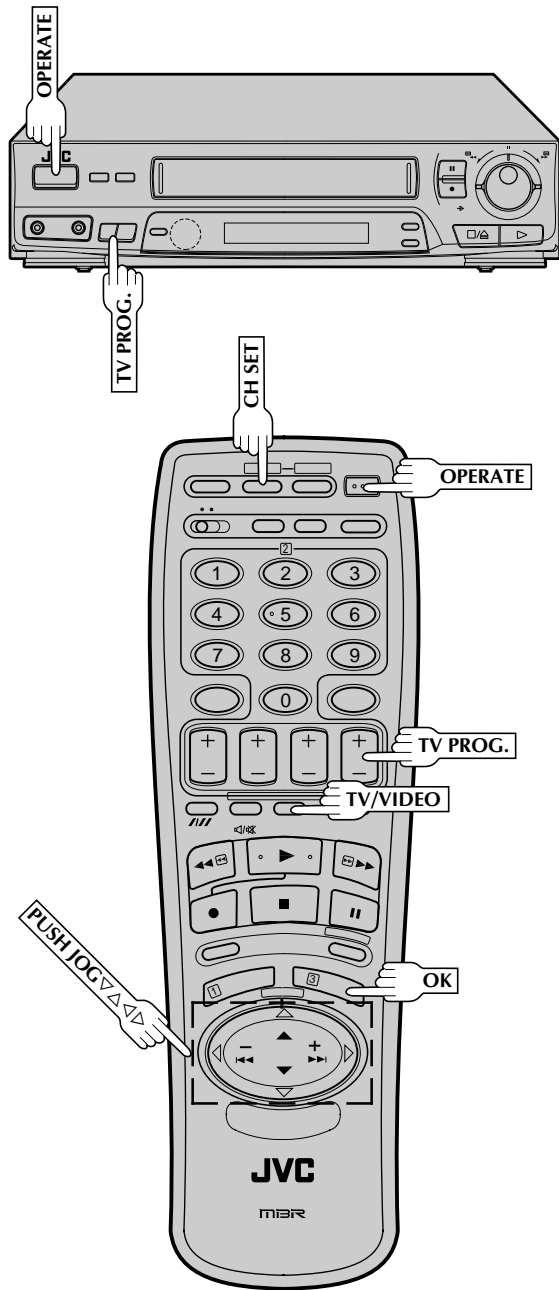

Your recorder needs to memorise all necessary stations in channel positions in order to record TV programmes. ATS+ (Auto Tuning System) automatically assigns all receivable stations in your area to call them up with the **TV PROG.** buttons without going through any vacant channels.

The following procedure describes how to select automatic channel setting.

1 TURN ON THE RECORDER

Press **OPERATE**.

- If your recorder is connected to the TV via AV connection, press **TV/VIDEO** to select the VIDEO mode.

2 ACCESS LANGUAGE SCREEN

Press and hold **CH SET** for more than 2 seconds. The Language screen appears.

3 SELECT LANGUAGE

Press **PUSH JOG** to place the pointer next to the language of your choice, then press **OK** to enter your selection. The Ch. Set mode menu appears.



4 SELECT MODE

"AUTO CH SET" is the necessary mode for this procedure, so simply press **OK** to enter the selection. The Country select screen appears.



5 SELECT COUNTRY

Press **PUSH JOG** to place the pointer next to your country's name, then press **OK** to initiate Auto Channel Set.

- As the recorder searches for receivable stations, it displays broadcasts from the stations for a few seconds as it locates them.



CONTINUED ON NEXT PAGE.



6

INITIAL SETTINGS (cont.)

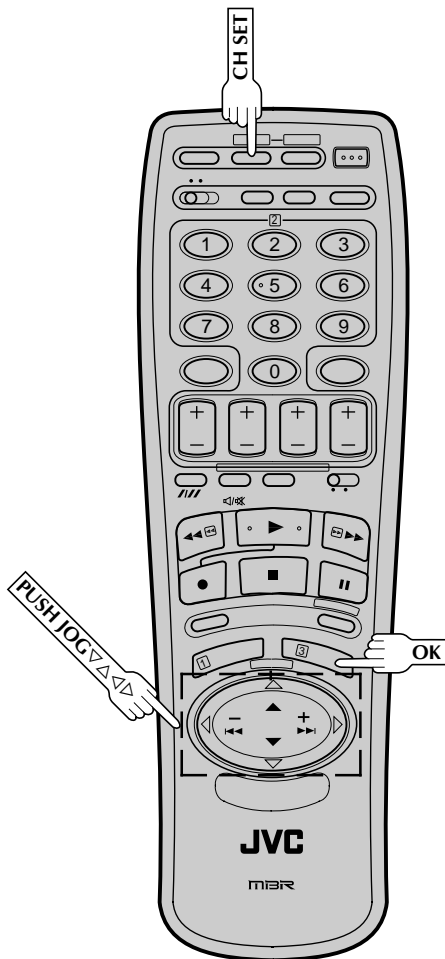
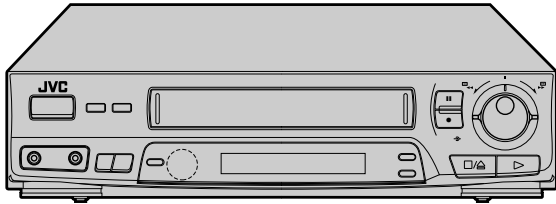

6

VIEW CONFIRMATION SCREEN

The stations your recorder located appear on a Confirmation screen — channel positions (PR), channels (CH) and station names (ID— pg. 31). To view the next page of the listing, press **PUSH JOG** $\Delta \nabla \triangleleft \triangleright$. The blueback screen and the program currently being broadcast by the highlighted station appear alternately for 5 seconds each.

PR	CH	ID	PR	CH	ID
01	25	ARD	08	C26	E-SP
02	C08	SKY1	09	55	WEST
03	10	ZDF	10	C24	SAT1
04	C65	RAI1	11	C23	OSF
05	C31	BBC1	12	C25	ESPN
06	C32	BBB2	13	C37	CNN
07	C33	3SAT	14	C35	

[$\Delta \nabla \triangleleft \triangleright$]:
 → [OK]: EDIT
 → [CANCEL]: DELETE
 [CH SET]: EXIT

- The stations located in the selected country appear at the top of the list.

RETURN TO NORMAL SCREEN

7

Press **CH SET**.

- Depending on the reception conditions, the stations may not be stored in order, and the station names may not be stored correctly.
- Using the Confirmation screen, you can skip or add channel positions, enter station names and perform other operations. Refer to page 29 for the procedures.
- For information on scrambled broadcasts, refer to page 29.

NOTES:

- Fine tuning is performed automatically when you select "AUTO CH SET". If you want to perform it manually, refer to page 30.
- To set the tuner manually, refer to "Storing Channels Manually" (pg. 29).

Clock Set

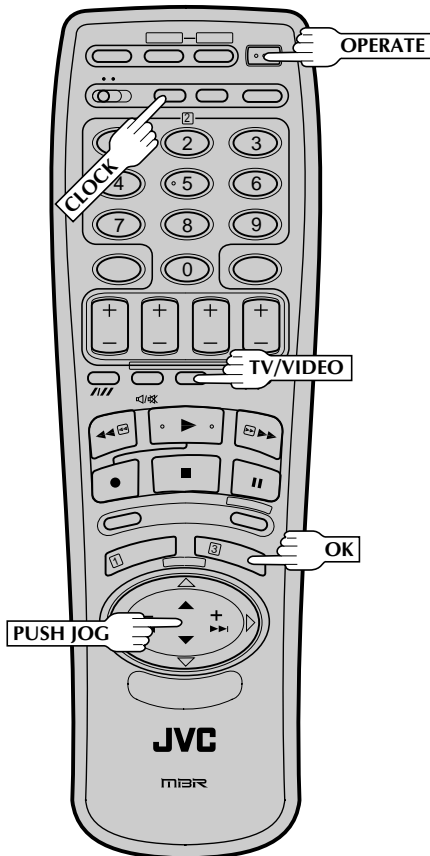
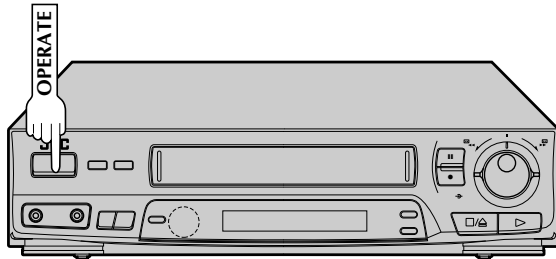

If you performed Auto Channel Set (pg. 5), the recorder's built-in clock is also set automatically. The Auto and Manual clock setting procedures are necessary when . . .

- a power outage of more than 60 minutes occurs.
- the tuner has been set manually.
- the user desires to set the clock slightly ahead of the actual time.
- the clock was not set even after Auto Tuner Set was performed.

Whether you perform Auto or Manual clock setting, you can use the convenient Just Clock function.

Just Clock

The Just Clock function provides accurate time keeping through automatic adjustments at regular intervals, by reading data from a PDC signal.

The Just Clock option appears in the Clock Set and Auto Clock screens, and can be set "ON" or "OFF" (the default setting is "ON"). Press **OK** until the Just Clock setting begins blinking, then press **PUSH JOG** to change the setting.

IMPORTANT: If you turn off Just Clock off, the accuracy of your recorder's built-in clock may be reduced, which could adversely effect timer recording.

Both Auto and Manual clock setting procedures begin from step 3.

Preparation

1 TURN THE RECORDER ON

Press **OPERATE**.

- If your recorder is connected to the TV via AV connection, press **TV/VIDEO** to select the VIDEO mode.

2 ACCESS CLOCK SET SCREEN

Press **CLOCK** on the remote control. The Clock Set screen appears.

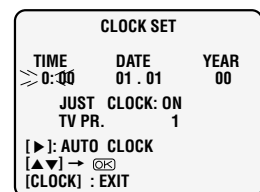

CONTINUED ON NEXT PAGE.

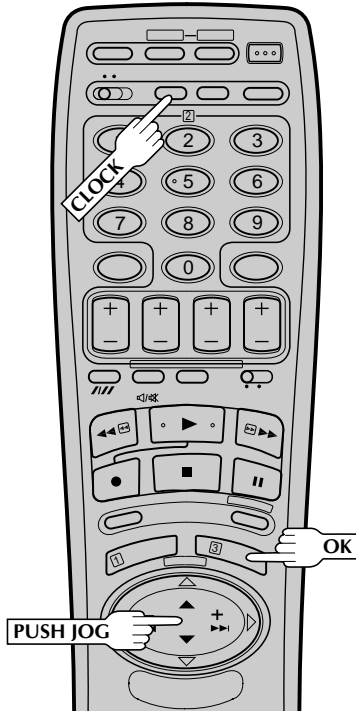
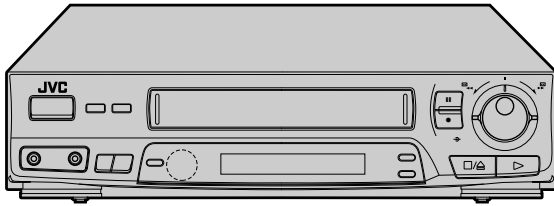

NOTES:

- Auto Clock and Just Clock require a PDC signal, and will not operate with a VPS signal.
- Just Clock (when set to "ON") enables adjustment of the recorder's built-in clock every hour on the hour, except for 11 o'clock in the evening and midnight.
- Just Clock is not effective when . . .
 - the recorder's power is on (unless the recorder is tuned to the same channel position selected in the Clock Set screen).
 - the recorder is in the Timer mode.
 - a difference of more than 3 minutes exists between the built-in clock's time and the actual time.
- If Just Clock is set to "ON", the recorder's clock is automatically adjusted at the start/end of Summer Time.
- Auto clock setting and Just Clock may not function properly depending on the reception condition.
- During Manual clock setting, if the day and month data are invalid (such as 31st April), the month digits are cleared automatically and the day digits begin blinking. Input the correct data.
- If, in step 3 of the Manual clock setting procedure, the year digits are automatically cleared and the day digits begin blinking, it is possible that you have input 29th February for a non-leap year. Input the correct data.

Auto Clock Set

3 SET CLOCK AUTOMATICALLY

At the Clock Set screen, press **PUSH JOG**▷. The Auto Clock screen appears and clock setting begins.

AUTO CLOCK
 ≧ PLEASE WAIT ≦

JUST CLOCK: ON
 TV PR. 1

- If "TV PR." isn't set to the channel position on which Auto Clock data is received, "ERROR" appears, and then the screen from step 2 reappears. To set "TV PR.", press **OK** to place the pointer next to it, then cycle through the numbers by pressing **PUSH JOG**△▽ until the number representing the channel position in which the station transmitting clock setting data is stored appears.

4 RETURN TO NORMAL SCREEN

Once clock setting is completed, press **CLOCK** to return to the normal screen.

Manual Clock Set

3 SET DATE AND TIME

Press **PUSH JOG**△▽ to set the hour, then press **OK**. The "minutes" display begins blinking. Repeat the procedure to set the minutes, day, month and year.

4 SET JUST CLOCK

The default setting is "ON". Set as desired by pressing **PUSH JOG**△▽, then press **OK**.

- If you set to "OFF", you can disregard the next step as you won't be able to receive regular clock adjustments.

5 SET CLOCK DATA SOURCE CHANNEL POSITION

The recorder is preset to receive clock setting and adjustment data from channel position 1. Press **PUSH JOG**△▽ to set the channel position to the number representing the station transmitting clock setting data, then press **OK**.

6 START CLOCK OPERATION

Press **CLOCK**.

Basic Playback

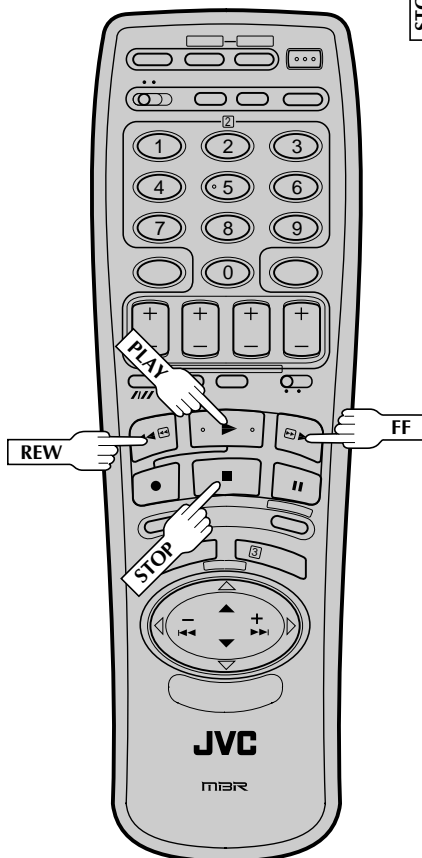
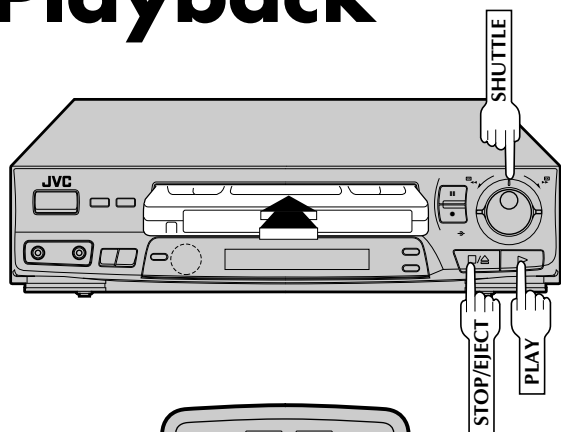

The easiest, most basic operation possible with your video recorder is tape playback. Already-recorded signals on a video tape are read by your video recorder and displayed on your TV just like a TV programme.

1 LOAD A CASSETTE

Make sure the window side is up, the rear label side is facing you and the arrow on the front of the cassette is point toward the recorder. Don't apply too much pressure when inserting.

- The recorder power comes on automatically and the counter is reset to 0:00:00.
- If the record safety tab has been removed, playback begins automatically.

2 FIND PROGRAMME START POINT

If the tape is advanced past the start point, press **REW** or turn the **SHUTTLE** ring to the left and release it. To go forward, press **FF** or turn the **SHUTTLE** ring to the right and release it.

3 START PLAYBACK

Press **PLAY**. "BEST" appears blinking in the recorder's display panel for 5 seconds. (☞ pg. 15)

4 STOP PLAYBACK

Press **STOP** on the remote or **STOP/EJECT** on the recorder's front panel. Then press **STOP/EJECT** to remove the cassette.

Usable cassettes

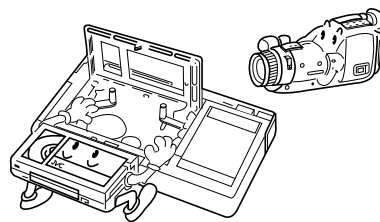

- Compact VHS camcorder recordings can be played on this video recorder. Simply place the recorded cassette into a VHS Cassette Adapter and it can be used just like any full-sized VHS cassette.
- This video recorder can record on regular VHS and Super VHS cassettes. However, it will record and play back regular VHS signals only. It is not possible to play back a recorded Super VHS tape.



Playback Features

Take advantage of special functions possible with the recorder's controls or the remote control.

NOTE:

Refer to the **SHUTTLE** ring illustration below as you read the following procedures.

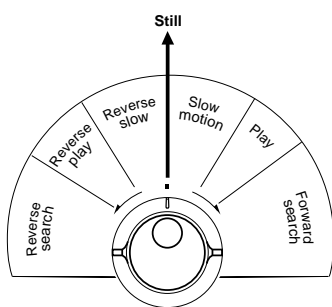

Still Picture/Frame-By-Frame Playback

1 PAUSE DURING PLAYBACK

Press **PAUSE**. If there is vertical jitter, use the **TV PROG.** buttons to correct the picture.

2 ACTIVATE FRAME-BY-FRAME PLAYBACK

Turn the **JOG** dial to the right for forward frame-by-frame playback, or to the left for reverse frame-by-frame playback. [J438E only]

OR

Press **PAUSE**.

OR

Press **PUSH JOG** ◀ or ▶.

To resume normal playback, press **PLAY**.

Slow Motion

1 ACTIVATE SLOW-MOTION PLAYBACK

During playback or still, turn the **SHUTTLE** ring to the right for forward slow motion, or to the left for reverse slow motion (refer to the illustration to the left).

OR

During still picture, press and hold **PAUSE** for 2 seconds, then release. Press and release again to return to still picture.

OR

During still picture, press and hold **PUSH JOG** ◀ or ▶. Release to return to still picture.

To resume normal playback, press **PLAY**.

Variable-Speed Search

1 ACTIVATE VARIABLE-SPEED SEARCH

During playback or still, turn the **SHUTTLE** ring to the right for forward variable-speed search, or to the left for reverse variable-speed search (refer to the illustration to the left).

OR

During playback, press **PUSH JOG** ◀ or ▶.

- The more times you press, the faster the playback picture moves.
- To decrease speed, press the button for the opposite direction.

To resume normal playback, press **PLAY**.

High-Speed (Turbo) Search

1 ACTIVATE HIGH-SPEED SEARCH

During playback or still, turn the **SHUTTLE** ring all the way to the right for forward high-speed search, or to the left for reverse high-speed search.

- For forward search with a visible picture, turn the **SHUTTLE** ring all the way to the right and release it within 1 second.
- For reverse search with a visible picture, turn the **SHUTTLE** ring all the way to the left and release it within 1 second.

OR

Press **FF** for forward high-speed search, or **REW** for reverse high-speed search.

- For short searches, press and hold **FF** or **REW** for over 2 seconds. When released, normal playback resumes.

To resume normal playback, press **PLAY**.



Manual Tracking

Your video recorder is equipped with automatic tracking control. During playback, you can override this and adjust the tracking manually by pressing the **TV PROG.** buttons.

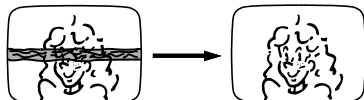

1 OVERRIDE AUTOMATIC TRACKING

Press **SP/LP (///)** on the remote to engage manual tracking.

2 ADJUST TRACKING MANUALLY

Press **TV PROG. +** or **-** to adjust tracking.

3 RETURN TO AUTOMATIC TRACKING

Press **SP/LP (///)** on the remote to re-engage automatic tracking.

NOTE:

When a new tape is inserted, the recorder enters the automatic tracking mode automatically.

Instant ReView

Simply by pressing a single button, the recorder power comes on, rewinds, and begins playback of the last timer-recorded programme. If you have several programmes recorded, you can easily access any of them.

NOTE:

Before starting, make sure that the recorder is off and that the Timer mode is disengaged.

1 ACTIVATE INSTANT REVIEW

Press **REVIEW**. The recorder power comes on and the recorder searches for the index code indicating the start of the last timer-recorded programme. Once it's found, playback begins automatically. The front display panel tells you how many programmes have been recorded. If you have, for example, 3 programmes, "REV 3" appears and blinks. To watch the first of the 3 programmes, press **REVIEW three times**. The recorder searches and begins playback automatically. You can access a programme as far as 9 index codes away from the current tape position.

NOTES:

- *Instant ReView is not possible while the recorder is in the Timer mode.*
- *The number displayed to the right of "REV" may not match the actual number of timer-recorded programmes when one or more of them is a PDC/VPS recording (see pg. 24).*

Repeat Playback

Your video recorder can automatically play back the whole tape 20 times repeatedly.

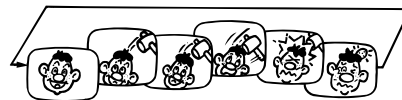

1 START PLAYBACK

Press **PLAY**.

2 ACTIVATE REPEAT PLAYBACK

Press **PLAY** and hold for over 5 seconds, then release.

- The Play indicator (▶) on the display panel blinks slowly.
- The tape plays 20 times automatically, and then stops.

3 STOP PLAYBACK

Press **STOP** at any time to stop playback.

NOTE:

Pressing **PLAY**, **REW**, **FF** or **PAUSE** also stops Repeat Playback.

NTSC Playback

Your video recorder is equipped with NTSC circuitry that can play back NTSC tapes.

1 LOAD A CASSETTE

Insert a cassette recorded in NTSC.

2 START PLAYBACK

Press **PLAY**. "NT" appears on the display panel.

- Some TVs shrink the picture vertically and place black bars at the top and bottom of the screen. This is not a malfunction on the part of either the video recorder or the TV.
- The picture may roll up and down. This can be corrected using the V-HOLD control found on some TVs. (This cannot be corrected if the TV does not have a V-HOLD control.)
- The counter and tape remaining time readings will be incorrect.
- During search, still, or frame-by-frame playback, the picture will be distorted, and there may be a loss of colour.
- Depending on the type of TV, the top and bottom portions of superimposed displays may be cut off during NTSC playback.

Scene Finder

This function helps you check contents of unlabeled recorded tapes at the touch of a single button.

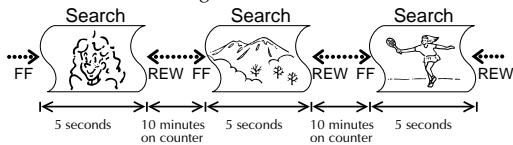

NOTES:

- Scene Finder cannot be used when the recorder is in the Record mode.
- If your recorder is connected to the TV using an AV connection, press **TV/VIDEO** to select the VIDEO mode.

1

ACTIVATE SCENE FINDER

Press **SCENE FINDER**. The recorder starts forward high-speed search for 5 seconds and then fast-forwards 10 minutes on the counter. This cycle is repeated until the end of the tape is reached.

- To start Scene Finder in the reverse direction, press **SCENE FINDER** and then turn the **SHUTTLE** ring to the left (or press the remote's **REW** button) within 2 seconds. This cycle is repeated until the beginning of the tape.
- During Scene Finder, the following indications appear on the display panel:



2

STOP SCENE FINDER

Press **STOP**.

NOTES:

- During Scene Finder high-speed search, you can also hear the tape sound. During fast forward or rewind, you hear the current TV sound instead.
- Scene Finder does not function during Index Search.

Tape Position Indicator

The tape position indicator appears on screen when, from the Stop mode, you press **FF**, **REW** or perform an Index Search. The position of "■" in relation to "0" (beginning) or "+" (end) shows you where you are on the tape.

"O.S.D." (pg. 17) must be set to "ON", or the indicator will not appear.

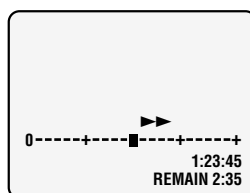

NOTE:

Depending on the type of tape used, there may be times when the indication is not correct.

Index Search

Your recorder automatically marks index codes at the beginning of each recording. This function gives you quick access to any one of 9 index codes in either direction.



NOTE:

Before starting, make sure the recorder is in the Stop mode.

1

ACTIVATE INDEX SEARCH

Press **PUSH JOG** ◀ or ▶ (◀◀ or ▶▶). "◀◀ 1" or "▶▶ 1" is displayed on screen and search begins in the corresponding direction.

- To access index codes 2 through 9, press **PUSH JOG** ◀ or ▶ repeatedly until the correct index number is displayed.

Ex.: To locate the beginning of B from the current position, press **PUSH JOG** ◀ twice.
To locate the beginning of D from the current position, press **PUSH JOG** ▶ once.

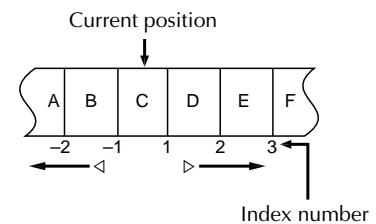

- When the specified index code is located, playback begins automatically.

Next Function Memory

You can set your recorder's power to go off automatically after the tape is fully rewound. Before starting, make sure the recorder is in the Stop mode.

For Automatic Power Off After Tape Rewind . . .
. . . press **REW**, then press **OPERATE** within 2 seconds.

NOTE:

If you want the power to be turned off automatically when the counter reads "0:00:00" (instead of at the beginning of the tape), press **C.MEMORY** so that the "M" mark appears before pressing **REW**.

Tape Remaining Time

1

DISPLAY REMAINING TIME

Press **DISPLAY** until the time remaining on the tape appears.

- By pressing the **DISPLAY** button, you can change the display to show the counter reading, tape remaining time, or clock time.

NOTE:

- Depending on the type of tape used, there may be times when the tape remaining time reading may not appear right away, or is not correct. "- : -" may sometimes appear, or the display may blink on occasion.

Counter Memory

Returns to the counter reading of "0:00:00" to conveniently find a specific place on the tape automatically.

1

SET COUNTER MEMORY

Press **C. RESET** during playback at a point you wish to locate later. The counter reads "0:00:00". Then press **C. MEMORY**, and "M" appears in front of the counter digits.

2

ACTIVATE COUNTER MEMORY

When you wish to return to the designated point, press **STOP** and then **REW** or **FF**.

- The tape rewinds or fast-forwards and stops at about 0:00:00 automatically.
- To cancel Counter Memory, press **C.MEMORY** again.

Remote A/B Code Switching

The remote control is capable of controlling two JVC video recorders independently; one set to respond to the remote control's A code control signals and another set to respond to B code control signals. The remote control is preset to send A code signals because your video recorder is initially set to respond to A code signals. You can easily modify your video recorder to respond to B code signals.

1

REMOVE POWER SUPPLY

Unplug the mains power cord from the mains outlet.

2

SET A/B CODE SWITCH

Set to B.

3

RE-SUPPLY POWER

Plug the mains power cord back into the mains outlet.

4

TURN THE RECORDER ON

Press **OPERATE** on the remote control. The recorder will now only respond to B code signals.

NOTE:

Some TV sets may malfunction in response to the B mode. If this happens, switch back to the A mode.

Information On Colour System

You can also record SECAM signals, or play back a MESECAM tape on this recorder. When a MESECAM tape is played back, "MES" appears on the display panel. MESECAM is the designation for tapes with SECAM signals that have been recorded on a MESECAM-compatible PAL video recorder.

Basic Recording

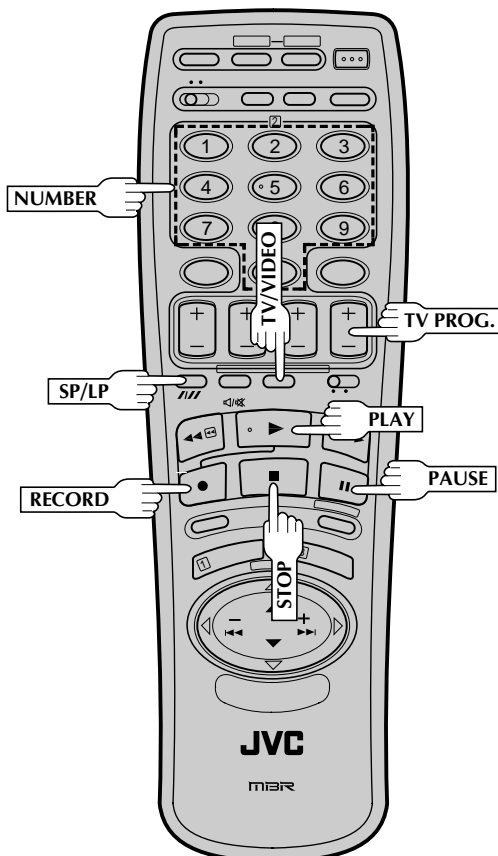
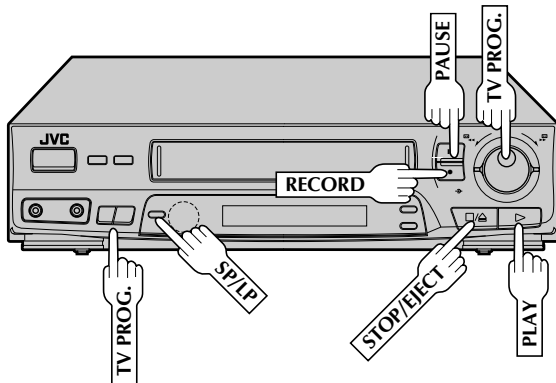

TV signals being received by the recorder's built-in tuner can be recorded onto a video tape. You can "capture" a TV programme using your video recorder.

1 LOAD A CASSETTE

Insert a cassette with the record safety tab intact.

- The counter is reset to 0:00:00 and the recorder power comes on automatically.
- If your recorder is connected to the TV via AV connection, press **TV/VIDEO** to select the VIDEO mode.

2 CHOOSE A PROGRAMME

Press **TV PROG.** +/- or the **NUMBER** keys to select the channel you wish to record. The name of the station appears in the recorder's display panel for 5 seconds, followed by the channel position number. (Only stations that appear in the Confirmation screen will be displayed.)

- The **TV PROG.** dial can also be used to select a channel. [J438E only]

3 SET TAPE SPEED (J438E ONLY)

Press **SP/LP**. Check the SP/LP indicator on the recorder display panel to confirm the selected tape speed.

4 START RECORDING

Press and hold **RECORD** and **PLAY** on the remote control, or press **RECORD** on the recorder.

B.E.S.T. takes place at the beginning of both the first SP and the first LP recording after inserting the cassette (see pg. 15).

5 PAUSE/RESUME RECORDING

Press **PAUSE**. Press **PLAY** to resume recording.

6 STOP RECORDING

Press **STOP** on the remote control or **STOP/EJECT** on the recorder. Then press **STOP/EJECT** to remove the cassette.

Accidental erasure prevention

- To prevent accidental recording on a recorded cassette, remove its safety tab. To record on it later, cover the hole with adhesive tape.

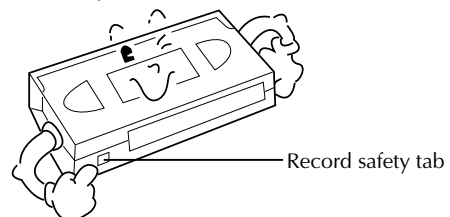

B.E.S.T. Picture System

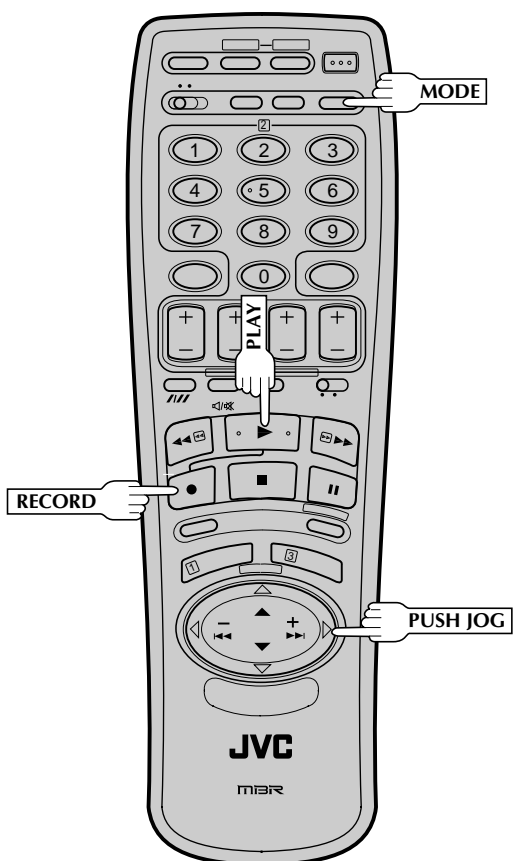
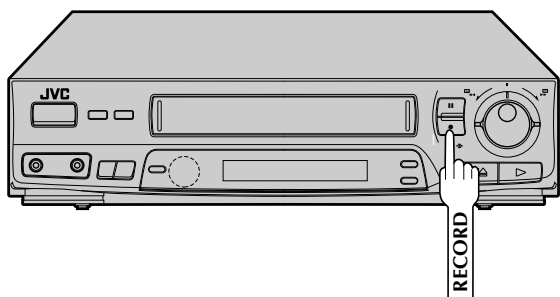

The B.E.S.T. (Biconditional Equalised Signal Tracking) system checks the condition of the tape in use during recording and playback, and compensates to provide the highest-possible recording and playback pictures. The default setting for both recording and playback is "ON".

Recording

1 LOAD A CASSETTE

Insert a cassette with the record safety tab intact.

- The recorder power comes on automatically.

2 ACCESS MODE SELECT SCREEN

Press **MODE**. The O.S.D./B.E.S.T. screen appears.

O.S.D.	: ON
B.E.S.T.	: ON

[▲▼] → [▶]: ON/OFF
[MODE] : EXIT

3 CONFIRM B.E.S.T. STATUS

The default setting is "ON". If this is the case, go to step 4. If not, press **PUSH JOG** to place the pointer next to "B.E.S.T.", then press **PUSH JOG** to set to "ON".

4 CLOSE MODE SELECT SCREEN

Press **MODE**.

5 START RECORDING

Press and hold **RECORD** and **PLAY** on the remote, or press **RECORD** on the recorder.

- The recorder spends approximately 7 seconds assessing the condition of the tape, then begins recording.
- When the "BEST" indicator begins blinking, that means adjustment is complete.

Display Panel Indication

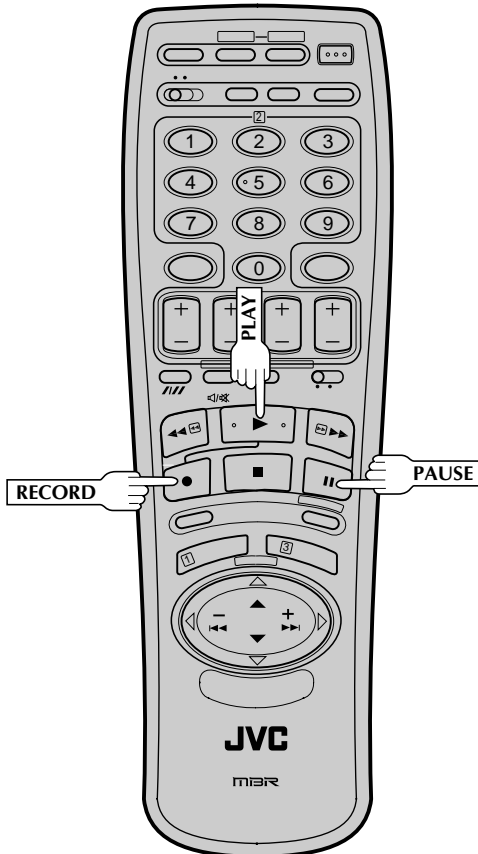
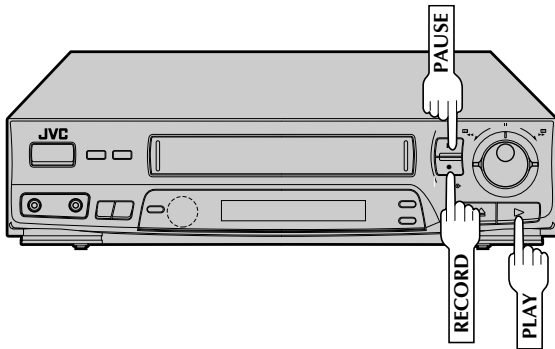

As the tape check progresses, the "—" marks on the display panel increase upward. Once the "BEST" indicator starts blinking, the check is complete.

**NOTES:**

- The B.E.S.T. system works for both SP and LP modes only after a tape has been inserted and the Record mode is first initiated. It does not work during recording.
- In the case of timer recording, the B.E.S.T. system works before recording is initiated.
- Once the cassette is ejected, the B.E.S.T. data is cancelled. The next time the cassette is used for recording, B.E.S.T. is re-performed.

ATTENTION:

Since the B.E.S.T. system works before recording actually starts, there is a delay of approximately 7 seconds after **RECORD** and **PLAY** on the remote are pressed, or **RECORD** on the recorder is pressed. To make sure you record the desired scene or programme in its entirety, first perform the following steps:

- 1) Press and hold **PAUSE** and **RECORD** to engage the RECORD PAUSE mode.
 - The recorder then automatically checks the condition of the tape and, after approximately 7 seconds, re-enters RECORD PAUSE.
- 2) Press **PLAY** to start recording.
 - If you want to bypass the B.E.S.T. system and begin recording immediately, set "B.E.S.T." to "OFF" in step 3 on page 15.

Playback

The recorder assesses the quality of the tape once you initiate playback.

When watching a tape recorded with "B.E.S.T." set to "ON", it is recommended that you leave B.E.S.T. on during playback as well.

START PLAYBACK

1

Press **PLAY**.

- The recorder adjusts the playback picture quality based on the quality of the tape in use.
- B.E.S.T. is active during Auto Tracking. "BEST" appears blinking on the recorder's display panel.

NOTES:

- When watching a rental tape, or one recorded on another video recorder, set B.E.S.T. to your preference by performing steps 2 through 4 on page 15.
- "BEST" only appears at the beginning of automatic tracking. Even though it doesn't appear after that, the B.E.S.T. function is operative.

On-Screen Displays

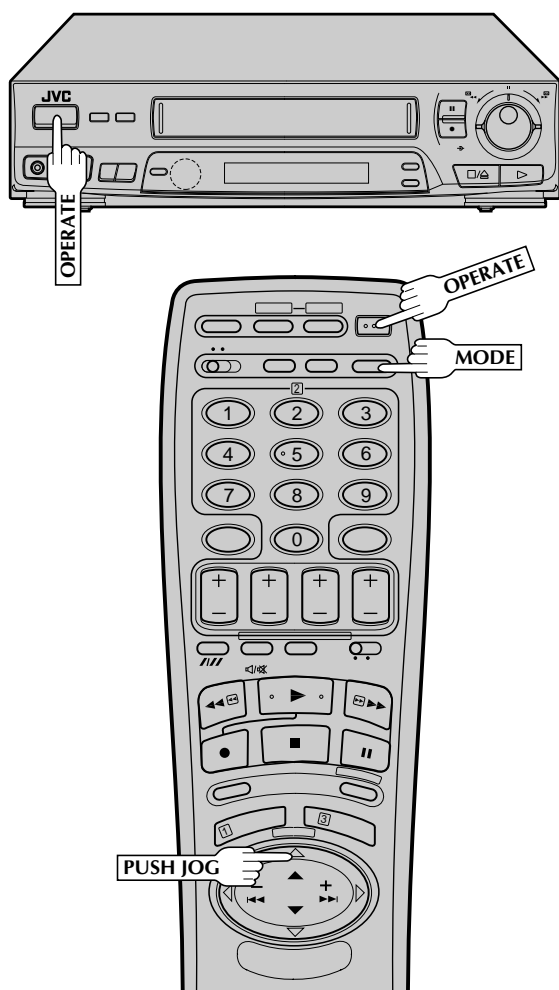

You can choose whether or not to have various operational indicators appear on screen, by setting this function ON or OFF. Messages appear in the language you selected during Auto Channel Set (☞ pg. 5).

TURN ON THE RECORDER

Press **OPERATE**.

ACCESS MODE SELECT SCREEN

Press **MODE**. The O.S.D./B.E.S.T. screen appears.

O.S.D. : ON
B.E.S.T. : ON

[▲▼] → [▶]: ON/OFF
[MODE] : EXIT

SELECT MODE

The pointer should already be next to "O.S.D.". If not, press **PUSH JOG**▲▼ to place it there.

ENABLE/DISABLE ON-SCREEN DISPLAY

The default setting is "ON", so if you want on-screen displays, leave the setting as is and go to step 5. If you don't want the displays to appear, press **PUSH JOG**▷ to set "O.S.D." to "OFF".

CLOSE MODE SELECT SCREEN

Press **MODE**.

The superimposed indication on the TV screen tells you what the recorder is doing.

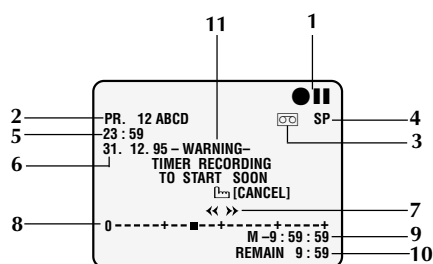

- 1- Operation mode indicators
- 2- Channel position number and station name/Aux. indicator (AUX1, AUX2 or F-AUX[J438E only])
- 3- Cassette loaded mark
- 4- Tape speed SP/LP/EP (EP is for NTSC playback only) [J438Eonly]
- 5- Clock display
- 6- Current day/month/year
- 7- Tape direction
- 8- Tape position indicator (☞ pg. 12)
- 9- Counter display (including Counter Memory indicator)
- 10- Tape remaining time indicator
- 11- Timer warning display

Recording Features

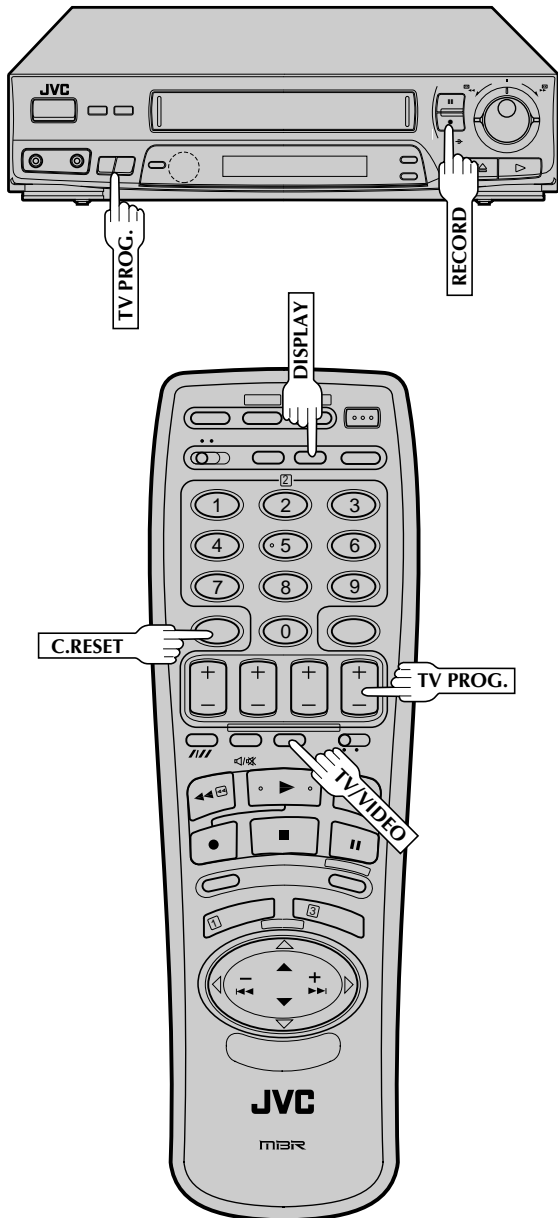

Record One Programme While Watching Another

If your recorder is connected to the TV via AV connection, press **TV/VIDEO**. The recorder's VIDEO indicator and the TV broadcast being recorded disappear.

1 SELECT CHANNEL TO WATCH

Once recording is in progress, all you need to do is to set the channel controls on the TV for the station you wish to view.

- The programme selected with the TV's channel controls appears on the TV screen while the one selected with the **TV PROG.** button is recorded on the tape.
- If a decoder is connected to the recorder (pg. 4), you can select a scrambled channel as well with the TV channel controls.

Elapsed Recording Time Indication

You can check the exact time of a recording.

1 SET COUNTER DISPLAY

Press **DISPLAY** until a counter reading appears on the display panel.

2 RESET COUNTER

Press **C. RESET** before starting recording or playback.

- The counter is reset to "0:00:00" and shows the exact elapsed time as the tape runs.

Instant Timer Recording (ITR)

This easy method lets you record for from 30 minutes to 6 hours (selectable in 30-min. increments), and shuts the recorder off after recording is finished.

1 START RECORDING

Press **RECORD** on the recorder.

2 ENGAGE ITR MODE

Press **RECORD** again. ITR blinks and 0:30 appears on the front display panel.

3 SET RECORDING DURATION

If you want to record for more than 30 minutes, press **RECORD** to extend the time. Each press extends recording time by 30 minutes.

NOTE:

You can only perform ITR using the **RECORD** button on the recorder's front panel.

Information On ShowView

With ShowView, timer programming is greatly simplified because each TV programme has a corresponding code number which your recorder is able to recognise.

NOTE:

"Guide Prog. Number" (GUIDE PROG) refers to the assigned TV station numbers, according to broadcast area, for ShowView timer recording.

IMPORTANT

Perform the following procedure after the channel setting steps on pages 5 and 29 – 30, and after the Clock Set procedure on page 7.

After setting the Guide Prog. Numbers, the station names and channel positions may be incorrect if you stored or skipped channels. In this case, re-perform Guide Prog. Number setting.

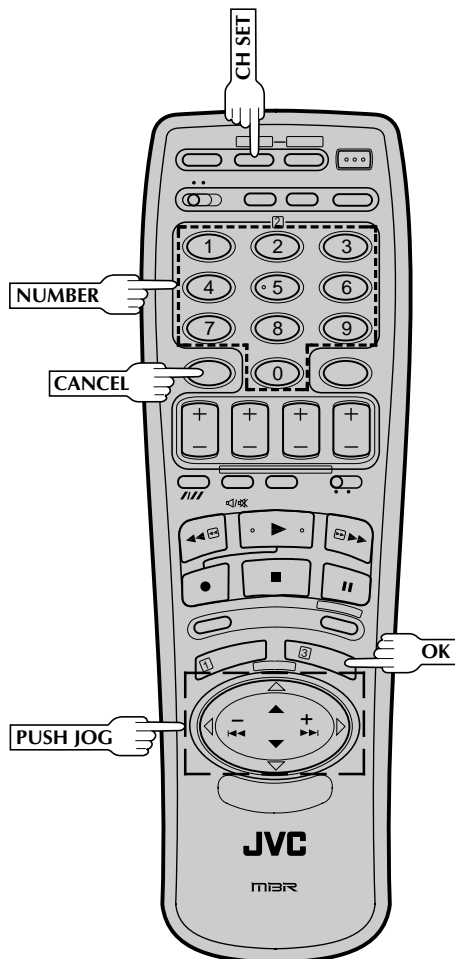
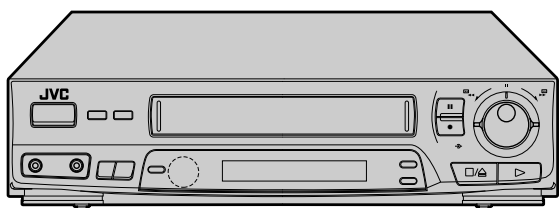

Guide Prog. Number Set

1 MAKE LIST OF STORED STATION NAMES AND CHANNEL POSITIONS

(Ex.)

Channel position	Station name
1	ARD
2	ZDF
3	WDR

2 ACCESS CH. SET MODE MENU SCREEN

Press and hold **CH SET** for over 2 seconds. The Language screen appears. Press **OK** to access the Ch. Set Mode Menu screen.

3 SELECT MODE

Press **PUSH JOG** to place the pointer next to "GUIDE PROG SET", then press **OK**. The Guide Prog. Set screen appears.



CONTINUED ON NEXT PAGE.

4

ENTER SHOWVIEW NUMBER

Press **OK**, and a cursor appears above "GUIDE PROG". Then, using the **NUMBER** keys, input the ShowView number (found in most TV listings) of a program scheduled to be broadcast on each station on the list from step 1, starting at the top. If you enter the wrong number, press **CANCEL** and input the correct number.

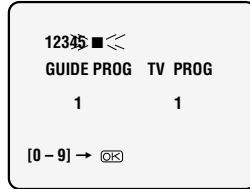

When entering a ShowView number for ARD

5

ENTER CHANNEL POSITION NUMBER

Press **OK** and the display under "TV PROG" begins blinking.

If the blinking number under "TV PROG" agrees with the channel position . . .

. . . press **OK**.

If the numbers do not agree . . .

. . . input the channel position using **PUSH JOG** Δ ∇ or the **NUMBER** keys, then press **OK**.



- If you input the ShowView number of a program that has already aired, "ERROR" appears on screen for a few seconds. Input the correct ShowView number.
- Repeat steps 4 and 5 as necessary.

6

CLOSE MENU

Press **CH SET** and selection is complete.

If you already know the Guide Prog. number for a station . . .

- 1- After step 3, press **PUSH JOG** \triangleright .
 - The GUIDE PROG number begins blinking.
- 2- Enter the Guide Prog. number using the **NUMBER** keys or **PUSH JOG** Δ ∇ , then press **PUSH JOG** \triangleright .
 - The TV PROG number begins blinking.
- 3- Enter the channel position using the **NUMBER** keys or **PUSH JOG** Δ ∇ , then press **PUSH JOG** \triangleleft .
 - Repeat 2 and 3 as necessary.
- 4- Press **CH SET**.

When Using A Satellite Tuner

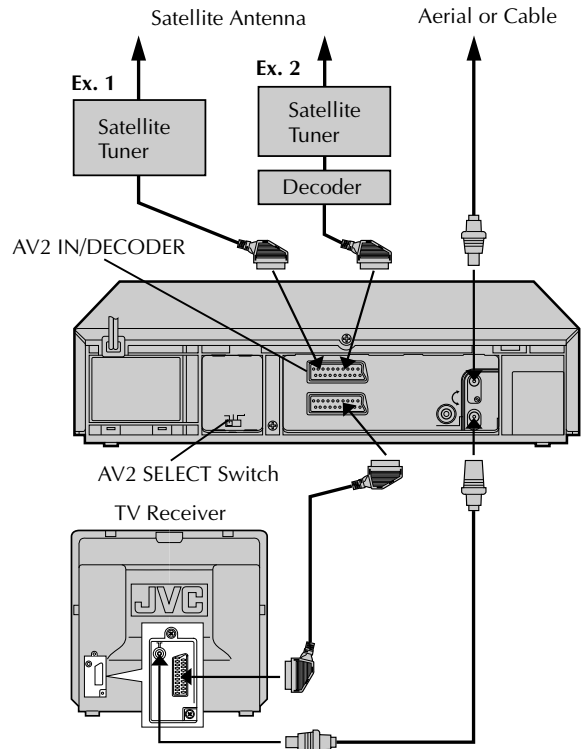

Preparation

- 1- Connect the satellite tuner to the AV2 IN/DECODER connector on the rear of your recorder.
- 2- Set the **AV2 SELECT** switch to "AV2".

To Record Satellite Broadcasts . . .

- 1- Select the appropriate channel on the satellite tuner.
- 2- Press **NUMBER** key "0" to set your recorder's input mode to "AUX2".
- 3- Start recording (☞ pg. 14, steps 3 - 6).

To Record Satellite Broadcasts Using ShowView Timer Recording . . .

- 1- Perform Guide Prog. Number setting.
 - In step 5 in the left column, press **NUMBER** key "0" to set "TV PROG" to "AUX2".
- 2- Perform ShowView Timer Recording (☞ pg. 21).

To Record Satellite Broadcasts Using Regular Timer Recording . . .

- 1- In step 6 on page 23, press **TV PROG**. +/- to set the channel position to "AUX2".

NOTES:

- During timer programming, once you have selected the programme you wish to record from the satellite tuner, set the system's timer. If your satellite tuner does not have a timer, leave it switched on.
- If your recorder's front panel VIDEO and/or AUDIO connectors are being used, they take priority and "AUX2" cannot be selected. Make sure no cables are connected to the front panel connectors when performing this procedure.

ShowView Timer Recording

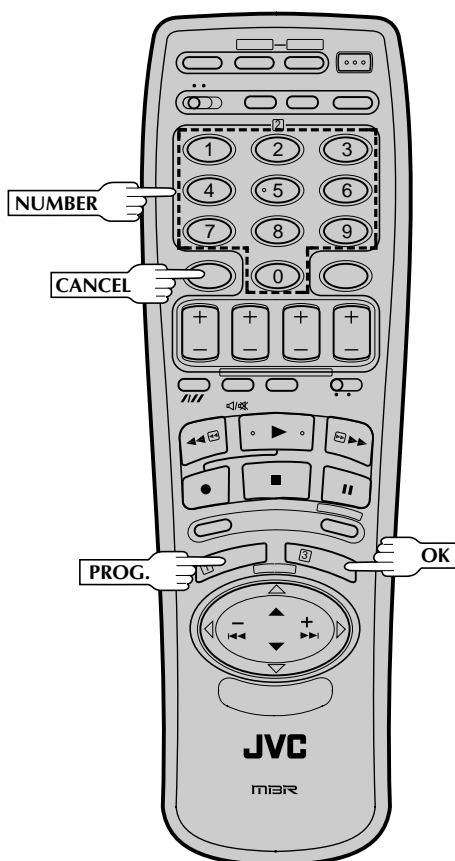
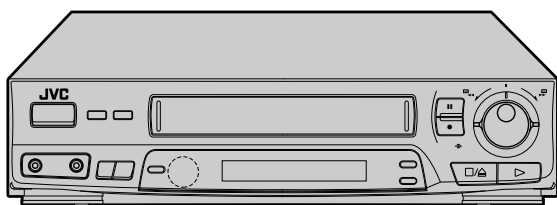

Before performing ShowView timer recording, be sure to read "Information On ShowView" (pg. 19).

Turn on the recorder first and perform the following steps.

1

ACCESS TIMER PROGRAMMING SCREEN

Press **PROG.**

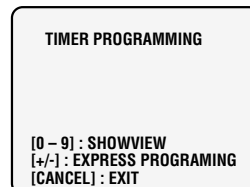

The front display panel looks like this:



2

ENTER SHOWVIEW NUMBER

Press the **NUMBER** keys to enter the ShowView number of a programme you wish to record.

- If you make a mistake, press **CANCEL** and then input the correct number.

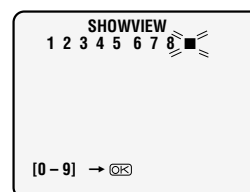

The ShowView number you enter appears on the front display panel:



3

ACCESS SHOWVIEW PROGRAM SCREEN

Press **OK**, and the ShowView Program screen appears (if you're just starting out, "P1" appears).

- If the number you entered is invalid, "ERROR" appears. Press **CANCEL** and input a valid ShowView number.

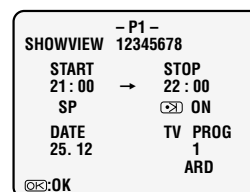

The front display panel looks like this:



- If you're not receiving PDC/VPS, press **NUMBER** key "7" to set [7] to "OFF" (pg. 24).

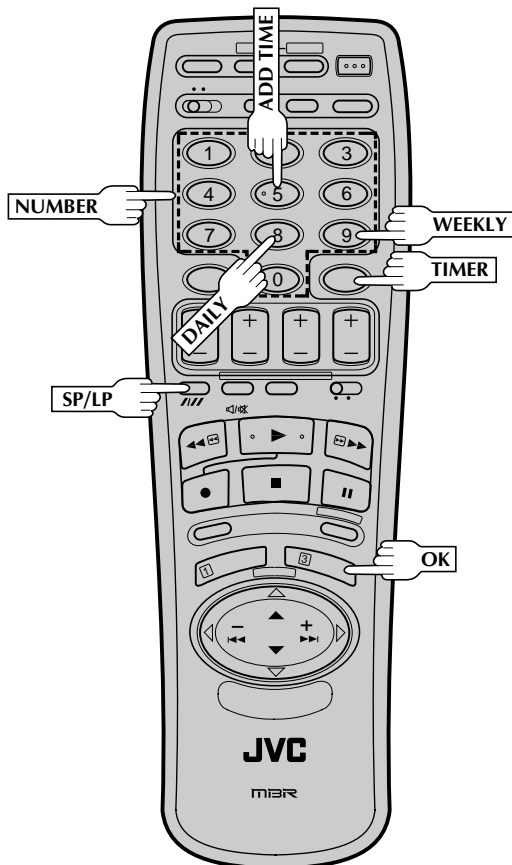
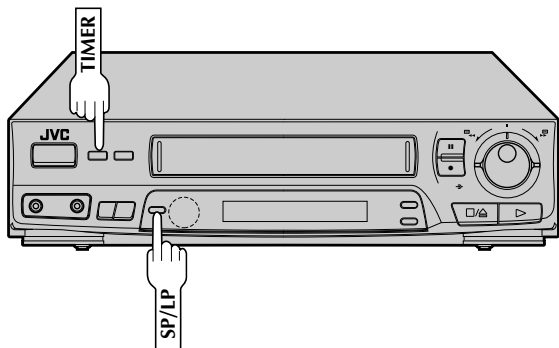

4 SET TAPE SPEED (J438E ONLY)

Press **SP/LP** to set the tape speed.

5 RETURN TO NORMAL SCREEN

Press **OK**.

- Repeat steps 1-5 for each additional programme.

6 ENGAGE RECORDER'S TIMER MODE

Press **TIMER**.

NOTE:

For safety, your recorder disables all other functions while in the *Timer mode*. If you want to use the recorder but its *Timer mode* is engaged, press **TIMER** and all other functions are operable. To re-engage the timer, press **TIMER**.

To Delay The Stop Time . . .

. . . press **ADD TIME** (**NUMBER** Key "5") after pressing **OK** in step 3. Each time you press, the Stop time is delayed by 5 minutes (meaning that 5 minutes of recording time is added). You can easily compensate for anticipated programme schedule delays this way.

To Timer-Record Weekly Or Daily Serials . . .

. . . after pressing **OK** in step 3, press **WEEKLY** (**NUMBER** key "9") for weekly serials or **DAILY** (**NUMBER** key "8") for daily serials (Monday-Friday).

You can programme this recorder to timer-record as many as 8 programmes. If you try to programme the recorder to record a ninth, "PROGRAM FULL" appears on screen and "FULL" appears on the front display panel. To record the extra programme, you must first cancel any unnecessary programmes (see pg. 24).

Regular Timer Programming

If you don't know the SowView number for the programme you wish to record, use the following procedure to set your recorder to timer-record the programme.

Remember, the clock must be set before you can programme the timer (☞ pg. 7).

Turn on the recorder first and perform the following steps.

1

ACCESS TIMER PROGRAMMING SCREEN

Press **PROG.**

2

ACCESS PROGRAMME SCREEN

Press **START +/-**. (If you're just starting out, "P1" appears.)

- P1 -	
START --:--	STOP --:--
SP	☑ ON
DATE 25.12	TV PROG --
[+/-] → ☑	

The front display panel looks like this:



3

ENTER PROGRAMME START TIME

Press **START +/-** to enter the time you want recording to start.

- Press and hold **START +/-** to move in 30-minute increments, or press and release repeatedly to move 1 minute at a time.

- P1 -	
START 21:00	STOP --:--
SP	☑ ON
DATE 25.12	TV PROG --
[+/-] → ☑	

The front display panel looks like this:

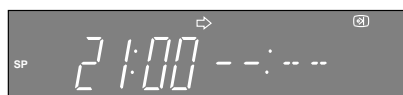

4

ENTER PROGRAMME STOP TIME

Press **STOP +/-** to enter the time you want recording to stop.

5

ENTER PROGRAMME DATE

Press **DATE +/-**. (The current date appears on screen. The date you enter appears in its place.)

6

ENTER CHANNEL POSITION

Press **TV PROG. +/-**.

- If you're not receiving PDC/VPS, press **NUMBER** key "7" to set ☑ to "OFF" (☞ pg. 24).

- P1 -	
START 21:00	STOP 22:00
SP	☑ ON
DATE 25.12	TV PROG 1 ARD
[+/-] → ☑	



7

SET TAPE SPEED (J438E ONLY)

Press **SP/LP** to set the tape speed.

8

RETURN TO NORMAL SCREEN

After confirming all information is correct, press **OK** and the normal screen appears.

- Repeat steps 1-8 for each additional programme.

9

ENGAGE RECORDER'S TIMER MODE

Press **TIMER**.

To Timer-Record Weekly Or Daily Serials . . .
 . . . anytime during steps 2 through 8, press **WEEKLY** (**NUMBER** key "9") for weekly serials or **DAILY** (**NUMBER** key "8") for daily serials (Monday-Friday).

NOTES:

- To timer-record from a satellite tuner connected to your recorder's AV2 IN/DECODER connector, press **TV PROG. +/-** in step 6 above to set the channel position to "AUX2".
- You can programme this recorder to timer-record as many as 8 programmes. If you try to programme the recorder to record a ninth, "PROGRAM FULL" appears on screen and "FULL" appears on the front display panel. To record the extra programme, you must first cancel any unnecessary programmes (☞ pg. 24).

Check And Cancel Programmes

1 ACCESS PROGRAMME SCREEN

Press **PROG CHECK**. Each time you press the next program's information appears.

- Press **OK** and watch the front display panel as the Start and Stop times, the Date and the Channel Position appear.
- If the recorder is turned on and the TV is set to its VIDEO mode, you can check program information on screen as well.

If All Information Is Correct . . .
 . . . programming is completed.

If You Wish To Revise Data . . .
 . . . with the recorder's power turned on, go to step 2.

If You Wish To Cancel A Program . . .
 . . . with the recorder's power turned on, press **CANCEL**. All information you input is deleted.

2 REVISE PROGRAMME INFORMATION

Input the appropriate data using the **START +/-**, **STOP +/-**, **DATE +/-** and **TV PROG. +/-** buttons on the remote control.

Timer Warning

If you have programmed your recorder to timer-record a programme or a series of programmes, a warning appears on screen to tell you that the recording is to start in 5 minutes.

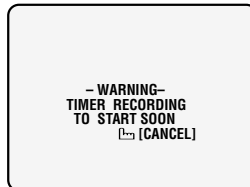

NOTES:

- The warning only appears if you're not in the Timer mode at that time.
- If this recorder is being used as the player for tape dubbing, the warning screen is recorded on the tape in the other video recorder.

The warning blinks for the entire 5 minutes leading up to the start of timer recording. To clear the display, press **CANCEL**.

Auto SP/LP Timer (J438E only)

If, when recording in SP mode, there is not enough tape to record the entire programme, the recorder automatically switches to LP mode to allow complete recording.

1 ENGAGE AUTO SP/LP TIMER

Press **AUTO SP/LP TIMER** on the recorder front panel. The button lights "green".

For Example . . .

Recording a program of 210 minutes in length onto a 180-minute tape

Approximately 150 minutes Approximately 60 minutes

SP mode	LP mode
Total 210 minutes	

Make sure you press **AUTO SP/LP TIMER** before performing timer programming.

NOTES:

- The Auto SP/LP Timer feature is not available during ITR (Instant Timer Recording), and the feature will not work properly with any tapes longer than E-180 as well as some tapes of shorter lengths.
- Even if, in step 1, you press **AUTO SP/LP TIMER** and it lights "green", that doesn't mean that the recorder will automatically change from SP to LP mode during the course of the recording. Watch the tape later to confirm.
- If you have programmed the recorder to timer-record 2 or more programs, the second programme and those thereafter may not fit on the tape if you engage the Auto SP/LP Timer mode. In this case, make sure the mode is not engaged, then set the tape speed manually during timer programming.
- There may be some noise at the point on the tape where the recorder switches from SP to LP mode.
- If you perform timer recording with both PDC/VPS and the Auto SP/LP Timer activated, and the programme goes beyond its originally scheduled length, there may be times when the programme cannot be recorded in its entirety.

PDC/VPS Recording

Now available from some TV stations, PDC (Programme Delivery Control) and VPS (Video Programme System) are service designed to assure safe, accurate timer recording. With this system, special code signals are transmitted together with the audio/video signals. These code signals control your video recorder and have precedence over advertised times you preset in the timer. This means that your recorder will start and stop recording when the preset TV programmes actually start and end — even if the broadcast time of a preset TV programme is changed.

To Use PDC/VPS Service . . .

The default setting for PDC/VPS is "ON". To cancel PDC/VPS, press **NUMBER** key "7" so that "OFF" is displayed on screen during ShowView or regular timer programming.

NOTES:

- When you manually enter programmes (regular timer programming), set the start time (PDC or VPS time) exactly as advertised in the TV listing. A different time than advertised will result in no recording.
- PDC/VPS recording is also possible when a satellite tuner or a cable system is connected to AV2 IN on your recorder.
- When PDC/VPS recording is performed, the Instant ReView programme readout number may not match the actual number of programmes that have been timer-recorded (☞ pg. 11).

Audio Dubbing (J438E only)

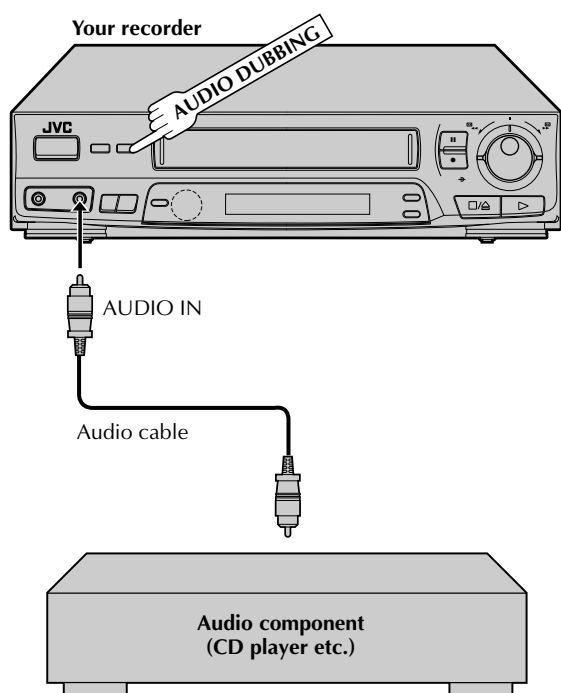

Audio dubbing replaces the normal audio sound of a previously recorded tape with a new soundtrack.

1 CONNECT AUDIO SOURCE

Connect using the AUDIO IN connector on the recorder's front panel.

2 SET INPUT MODE

Press **NUMBER** key "0" to set the input mode. "F-AU" appears in the recorder's display panel instead of a channel position number.

3 START PLAYBACK

Press **PLAY**.

4 FIND START POINT FOR DUBBING

Watch the tape as it plays back, and when you reach the point where you want dubbing to start, press **PAUSE**.

5 ENGAGE AUDIO DUB MODE

Press **AUDIO DUBBING**.

6 START SOURCE PLAYBACK

Engage the audio source's Play mode.

7 START AUDIO RECORDING

Press **PLAY**, and audio dubbing begins.

- To stop dubbing temporarily, press **PAUSE**.

8 STOP AUDIO DUBBING

Press **STOP** to stop the recorder, and engage the audio source's Stop mode.

NOTES:

- Audio dubbing stops automatically when the counter reaches "0:00:00", and the recorder enters the Play mode. Check the counter reading before beginning audio dubbing.
- Audio dubbing is also possible with input via the rear panel AV1 or AV2. With AV2, set the **AV2 SELECT** switch to "AV2".
- Connections made to the front panel **AUDIO** and **VIDEO IN** connectors are given priority over the rear panel AV1 and AV2 input connectors.

Edit To Or From Another Video Recorder

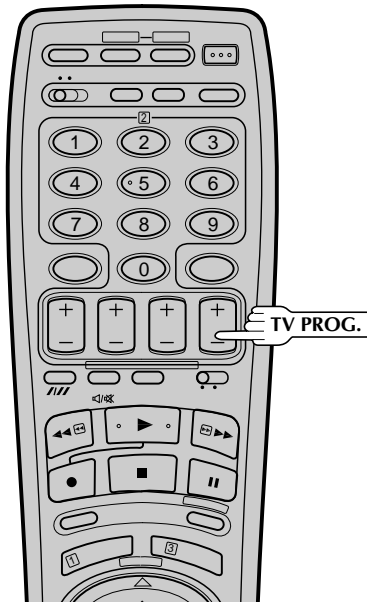

You can use your video recorder as the source player or the recording deck.

1 MAKE CONNECTIONS

Connect the player's AUDIO/VIDEO OUT connector to the recorder's AUDIO/VIDEO IN connector.

When Using Your Video Recorder As The Source Player . . .
 . . . connect its AV1 IN/OUT connector to the recording deck.

When Using Your Video Recorder As The Recording Deck . . .
 . . . you can use the AV1 IN/OUT or AV2 IN connectors.

2 SET RECORDING DECK'S INPUT MODE

Set to AUX. With this video recorder, press **NUMBER** Key "0" or **TV PROG.** to select depending on the connector being used — "AU 1" for the AV1 IN/OUT connector, or "AU 2" for the AV2 IN connector.

- When using the AV2 IN connector, make sure the **AV2 SELECT** switch is set to "AV2".

3 START SOURCE PLAYER

Engage its Play mode.

4 START RECORDING DECK

Engage its Record mode.

NOTE:

All necessary cables can be obtained from your dealer.

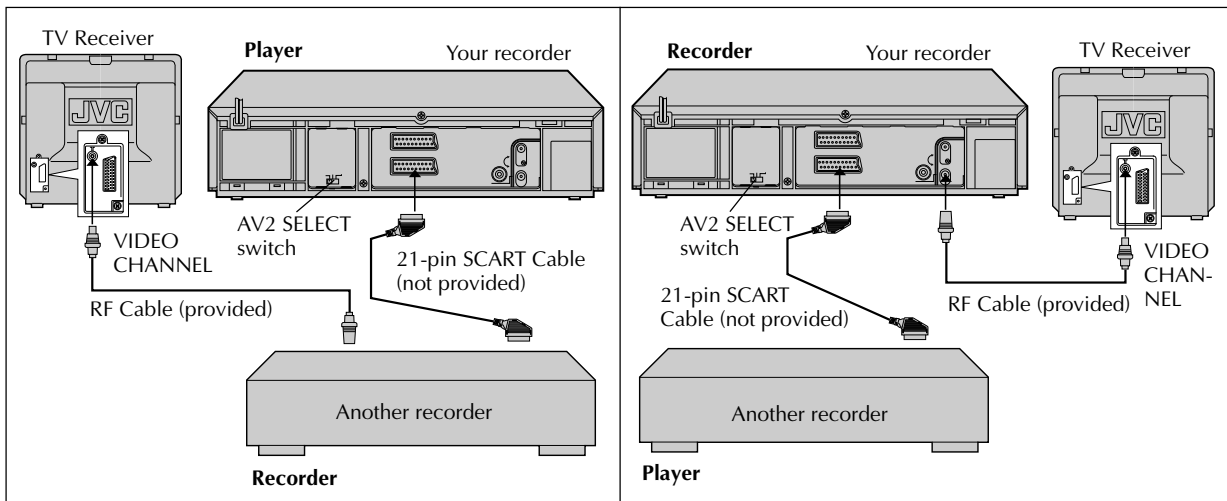

Edit From A Camcorder

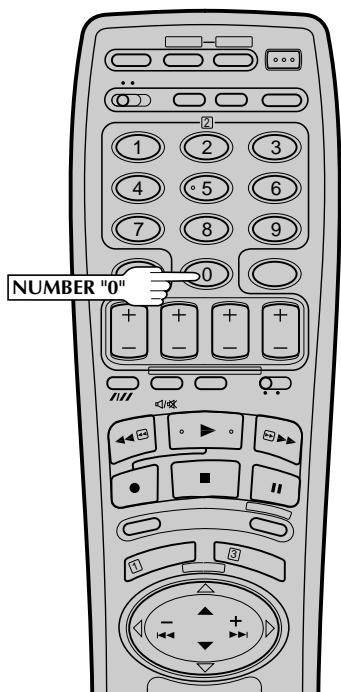

You can use a camcorder as the source player and your video recorder as the recorder.

1 MAKE CONNECTIONS

To J438E Owners:

Connect the camcorder's AUDIO/VIDEO OUT connectors to the recorder's front panel AUDIO/VIDEO input connectors.

- When a Master Edit Control-equipped JVC camcorder is used, the camcorder is capable of controlling the recorder. Refer to the camcorder's instruction manual for operating procedure.

To J238E Owners:

Connect the camcorder's AUDIO/VIDEO OUT connectors to the recorder's AV1 IN/OUT or AV2 IN connector.

2 SET RECORDER'S INPUT MODE

To J438E Owners:

Press **NUMBER** key "0". "F-AU" appears in place of a channel number.

To J238E Owners:

Press **NUMBER** key "0" or **TV PROG.** to select depending on the connector being used — "AU 1" for the AV1 IN/OUT connector, or "AU 2" for the AV2 IN connector.

- When using the AV2 IN connector, make sure the **AV2 SELECT** switch is set to "AV2".

3 START CAMCORDER

Engage its Play mode.

4 START RECORDER

Engage its Record mode.

NOTE:

Connections made to the front panel AUDIO/VIDEO input connectors automatically override those made to the rear panel AUDIO/VIDEO input connectors. [J438E only]

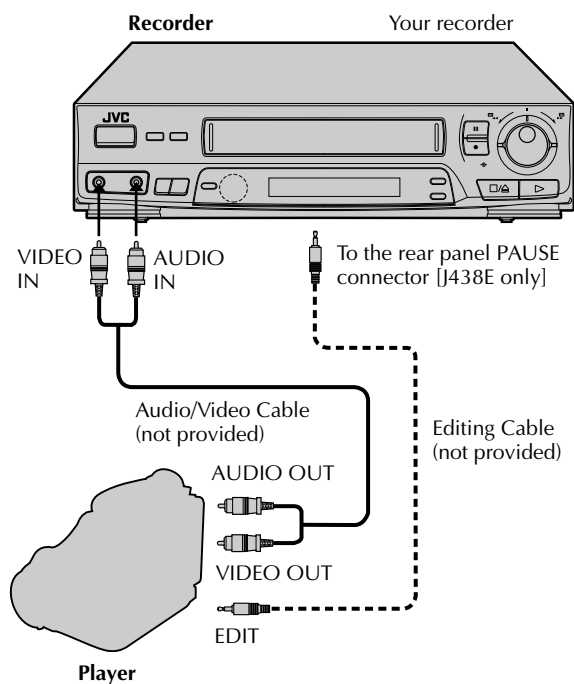

Multi-Brand Remote Control

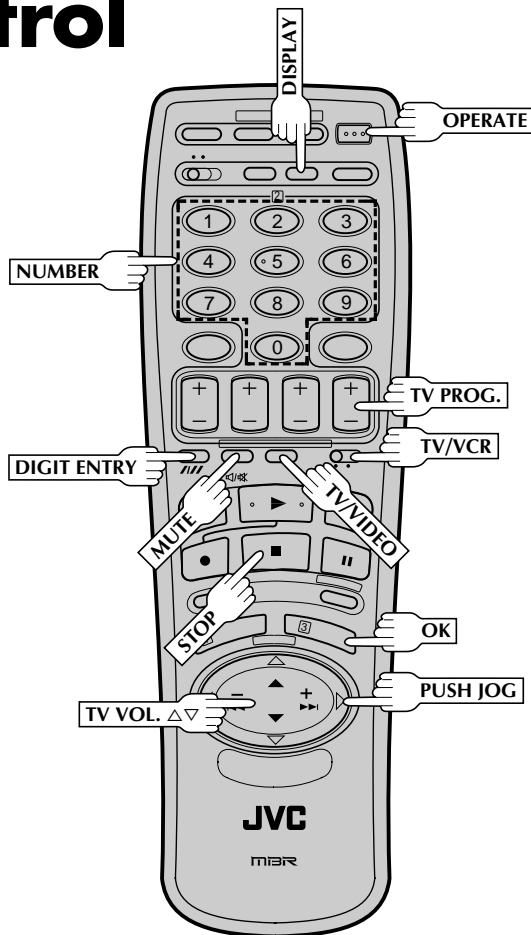

CODE	TV BRAND NAME
01	JVC
02	BRANDT, NORDMENDE, SABA, TELEAVIA, TELEFUNKEN, THOMSON
03	FERGUSON
04	PHILIPS
05	BLAUPUNKT, GRUNDIG
06	SONY
07	PANASONIC
08	GRAETZ, ITT, LUXOR, SALORA, SELECO
09	MIVAR
10	HITACHI
11	TOSHIBA
12	MITSUBISHI
13	FINLUX
14	NOKIA

Your remote control can operate the basic functions of your TV set. In addition to JVC TVs, other manufacturer's TVs can also be controlled by setting the appropriate switch on the remote control.

Before you start . . .

- Turn on the TV using its remote control.
- Set the remote control's **TV/VCR** switch to TV.

NOTE:

If your TV is a JVC, you don't have to set the code in step 1. Go to step 2.

1 SET TV BRAND CODE

Refer to the chart below. While holding down **OPERATE**, enter your TV's brand code using the **NUMBER** keys, then press **STOP**.

- You don't have to repeat this step until you replace your remote control's batteries.

2 TRY OPERATING TV

Press **OPERATE** on the remote to turn the TV off. If it goes off, try other operations.

- The **OPERATE** button, **TV/VIDEO** button, **TV PROG.** +/- button, **TV VOL. Δ∇** button and **MUTE** button on the remote can all be used to operate the TV.
- To return the remote to video recorder control, set its **TV/VCR** switch to VCR.

IMPORTANT

Although the provided remote control unit is compatible with JVC televisions, as well as many other models, it may not work with your TV, or in some instances, may have limited function capability.

Control Your TV Using Additional Buttons

The **NUMBER** keys on the remote can also be used to select the TV's channel by setting the remote control to the TV mode.

- 1 Set the **TV/VCR** switch to TV.
- 2 Use the **NUMBER** keys, and the **DIGIT ENTRY** (//) button, the **PUSH JOG** button, the **DISPLAY** button or the **OK** button to select the TV's channel.
 - With televisions under Code 01, 03, 04, 06, 07, 10 or 11, the **DIGIT ENTRY** button corresponds to the 1-digit/2-digit entry switching button (often labelled - / -) of your TV's remote control.
 - With televisions under Code 01, 08 or 09, the **PUSH JOG** < button corresponds to the 10 + button, and the **PUSH JOG** > button corresponds to the 20 + button of your TV's remote control.
 - With televisions using Code 09, the **DISPLAY** button corresponds to the 30 + button.
 - With televisions using Code 06, the **OK** button corresponds to the ENTER button of your TV's remote control.

NOTE:

The way these buttons are used is determined by your TV. Use these buttons as instructed for your TV's remote control.

Storing Channels Manually

Store channels that were not stored during Auto Channel Set.

- 1** **ACCESS CH. SET MODE MENU**
Press and hold **CH SET** for more than 2 seconds. The Language screen appears. Press **OK**. The Ch. Set Mode menu appears.
- 2** **SELECT MODE**
Press **PUSH JOG** $\Delta \nabla$ to select "MANUAL CH SET", then press **OK**. The Confirmation screen appears.
- 3** **SELECT POSITION**
Press **PUSH JOG** $\Delta \nabla \triangleleft \triangleright$ until an open position in which you want to store a channel begins blinking, then press **OK**. The Manual Ch. Set screen appears.
- 4** **INPUT CHANNEL**
The number "02" appears blinking beneath "CH". Press the **NUMBER** keys to input the channel number you want to store.
 - Although "CH" is set to "02", when the Manual Ch. Set screen appears, to store channel 02, you must select "02" using the **NUMBER** keys.
 - For fine tuning adjustment, press **PUSH JOG** \triangleright until the item beneath "CH" begins blinking, then press **PUSH JOG** $\Delta \nabla$. While tuning, "F+" or "F-" appears.
 - If necessary, to change the band between CH(regular) and CC(cable), press **PUSH JOG** $\triangleleft \triangleright$ until CH or CC is blinking, then press **PUSH JOG** $\Delta \nabla$ to select the band.
 - When storing a channel that sends scrambled broadcasts, press **PUSH JOG** \triangleright until "DECODER" blinks, then press **PUSH JOG** $\Delta \nabla$ to set "DECODER" to "ON" ("OFF" is the default setting).
- 5** **ENTER NEW CHANNEL INFORMATION**
Press **OK** or **STORE**, and the Confirmation screen appears.
 - Repeat steps 3 through 5 as necessary.
- 6** **CLOSE CONFIRMATION SCREEN**
Press **CH SET**.
 - To input the station name, see page 30.
 - To change positions, see "Change Station Channel Position" (at right).

When Receiving A Scrambled Broadcast

Make sure that the **AV2 SELECT** switch is set to "DECODER" (pg. 4).

- 1- Perform steps 1 and 2 above.
- 2- Press **PUSH JOG** $\Delta \nabla \triangleleft \triangleright$ to select the position of the channel broadcasting the scrambled programmes, then press **OK** three times.

- 3- Press **PUSH JOG** \triangleright until "DECODER" begins blinking, and set it to "ON" by pressing **PUSH JOG** $\Delta \nabla$.
- 4- Press **OK** to access the Confirmation screen.
 - Repeat steps 2 – 4 for each additional channel.
- 5- Press **CH SET**.

Perform steps 1 and 2 of the previous procedure to access the Confirmation screen before continuing.

Delete A Channel

- 1** **SELECT ITEM**
Press **PUSH JOG** $\Delta \nabla \triangleleft \triangleright$ until the item you want to delete begins blinking.
- 2** **DELETE CHANNEL**
Press **CANCEL**.
 - The item directly beneath the cancelled one moves up one line.
 - Repeat steps 1 and 2 as necessary.
- 3** **CLOSE CONFIRMATION SCREEN**
Press **CH SET**.

Change Station Channel Position

- 1** **SELECT ITEM**
Press **PUSH JOG** $\Delta \nabla \triangleleft \triangleright$ until the item you want to move begins blinking. Then press **OK** and the station name (ID) and its channel (CH) number begin blinking.
- 2** **SELECT NEW POSITION**
Press **PUSH JOG** $\Delta \nabla \triangleleft \triangleright$ to move the station to the new channel position, then press **OK**.
Example: If you moved the station in position 3 to position 7, the stations originally in positions 4–7 each move up one space.
 - Repeat steps 1 and 2 as necessary.
- 3** **CLOSE CONFIRMATION SCREEN**
Press **CH SET**.



Perform steps 1 and 2 of "Storing Channels Manually" on page 29 to access the Confirmation screen before continuing.

Set Stations (A)

1 SELECT ITEM
Press **PUSH JOG** $\Delta \nabla \triangleleft \triangleright$ until the item you want begins blinking. Then press **OK** twice and the station's name (ID) begins blinking.

2 SELECT NEW STATION
Press **PUSH JOG** $\Delta \nabla$ until the new station's name (ID) you want to store begins blinking. Registered station names (pg. 31) appear as you press **PUSH JOG** $\Delta \nabla$.

3 SWITCH STATIONS
Press **OK**.

- Repeat steps 1 through 3 as necessary.

4 CLOSE CONFIRMATION SCREEN
Press **CH SET**.

Fine-Tuning Channels Already Stored

1 SELECT CHANNEL TO FINE-TUNE
Press **PUSH JOG** $\Delta \nabla \triangleleft \triangleright$ until the channel you want to tune begins blinking.

2 ACCESS MANUAL CH. SET SCREEN
Press **OK** three times. The Manual Ch. Set screen appears.

3 PERFORM TUNING
Press **PUSH JOG** $\Delta \nabla$ until the picture is its clearest. Then press **OK**.

- The Confirmation screen appears.
- Repeat steps 1 through 3 as necessary.

4 CLOSE CONFIRMATION SCREEN
Press **CH SET**.

Set Stations (B)

NOTE:

First perform step 1 of the above procedure.

2 SELECT STATION NAME CHARACTER
Press **PUSH JOG** \triangleright and the first letter of the station name begins blinking.

3 ENTER NEW CHARACTER
Press **PUSH JOG** $\Delta \nabla$ to cycle through the characters (A-Z, 0-9, -, *, +, (space)) and stop when the desired one is indicated, then press **PUSH JOG** \triangleright to enter. Enter the remaining characters the same way (maximum of 4). After entering all characters, press **OK**.

- Repeat steps 1 through 3 as necessary.
- If you make a mistake, press **PUSH JOG** \triangleleft until the incorrect character begins blinking. Then enter the correct character by pressing **PUSH JOG** $\Delta \nabla$.

4 CLOSE CONFIRMATION SCREEN
Press **CH SET**.



TV STATION AND ID LIST

ID*	STATION NAME
1000	TV1000
3SAT	3SAT
ADLT	ADULT
ANT3	ANTENA3
ARD	ARD
ARTE	ARTE
BBC	BBC GROUP
BBC1	BBC1
BBC2	BBC2
BR3	BAYERN3
C+	CANAL PLUS
C1	PORTUGUSES
CAN5	CANALE5
CH4	CHANNEL4
CH5	CHANNEL5
CHLD	CHILD
CINE	CINEMA
CLUB	TELECLUB
CMT	CMT
CNN	CNN
CSUR	ANDALUCIA
DISC	DISCOVERY
DR	DR TV
DRS	DRS
DSF	DSF
ETB1	ETB1
ETB2	ETB2
EURO	EURONEWS
EUSP	EUROSPORTS
FEMM	FEMMAN
FILM	FILM
FNET	FILMNET
FR2	France2
FR3	France3
GALA	GALAVISION
HR3	HESEN3
INFO	INFO-KANAL
ITA1	ITALIA1
ITA7	ITALIA7
ITV	ITV
JSTV	JSTV
KA2	KA2
KAB1	KABEL1
KAN2	KANAL2
LOCA	LOCAL
M6	M6
MBC	MBR
MCM	MCM
MDR	MDR
MOVE	MOVIE
MTV	MTV
MTV3	MTV3
N3	NORD3
N-TV	N-TV
NBC	NBC SUPER
NDR	NDR
NED1	NED1
NED2	NED2
NED3	NED3
NEWS	
NRK	NRK
ODE	ODEON
ORF1	ORF1

ID*	STATION NAME
ORF2	ORF2
ORF3	ORF3
OWL3	OWL3
PREM	PREMIERE
PRO7	PRO7
RAI1	RAI1
RAI2	RAI2
RAI3	RAI3
RET4	RETE4
21	TELE21
RTBF	RTBF1 or 2
RTL	RTL
RTL2	RTL2
RTL4	RTL4
RTP	RTP
S4	SCHWEIZ4
SAT1	SAT1
SBS	SBS
SHOW	SHOW
SIC	SOCIEDADE
SKY	SKY CHANNEL
SKYN	SKY NEWS
SPRT	SPORT
SRTL	SUPER RTL
STAR	STAR-TV
SVT1	SVT1
SVT2	SVT2
SW3	SUEDWEST3
TCC	TCC
TELE	TELE
TEL5	TELE5
TF1	TF1
TM3	TM3
TMC	TELEMONTECARLO
TNT	TNT INT
TRT	TRT INT
TSI	TSI
TSR	TSR
TV1	BRTN TV1
TV2	BRTN TV2
TV3	TV3
TVE1	TVE1
TVE2	TVE2
TVG	TV GALICIA
TVI	TV INDEPENDENT
TVN	TV NORGE
VCR	VIDEO
VERO	VERONICA
VH-1	VH-1
VIVA	VIVA
VIV2	VIVA2
VMTV	VIDEO MUSIC
VOX	VOX
VT4	VT4
VTM	VTM
WDR1	West1
WDR3	West3
YLE1	YLE1
YLE2	YLE2
ZDF	ZDF
ZTV	ZTV

* The ID designator appears on your recorder's front display panel and in the on-screen listing.

Before requesting service for a problem, use this chart and see if you can repair the trouble yourself. Small problems are often easily corrected, and this can save you the trouble of sending your video recorder off for repair.

POWER		
SYMPTOM	POSSIBLE CAUSE	CORRECTIVE ACTION
1. No power is applied to the recorder.	<ul style="list-style-type: none"> The mains power cord is disconnected. 	Connect the mains power cord.
2. The clock is functioning properly, but the recorder cannot be powered.	<ul style="list-style-type: none"> "⊖" is displayed on the display panel. 	Press the TIMER button to turn the "⊖" indicator off.
TAPE TRANSPORT		
SYMPTOM	POSSIBLE CAUSE	CORRECTIVE ACTION
1. The tape does not run during recording.	<ul style="list-style-type: none"> "□□" is displayed on the display panel. 	Press PLAY to turn the "□□" indicator off.
2. The tape stops during rewind or fast-forward.	<ul style="list-style-type: none"> "M" is displayed on the display panel. 	Press C.MEMORY to deactivate the Counter Memory function and turn the "M" indicator off.
3. The tape will not rewind or fast-forward.	<ul style="list-style-type: none"> The tape is already fully rewound or fast-forwarded. 	Check the cassette.
PLAYBACK		
SYMPTOM	POSSIBLE CAUSE	CORRECTIVE ACTION
1. The playback picture does not appear while the tape is running.	<ul style="list-style-type: none"> If you're using the RF OUT connection, the TV receiver's channel selector is set to the wrong video channel. If you're using the AV connection, the TV receiver is not set to the AV mode. 	<p>If you are using the RF OUT connection, set the TV receiver to the RF converter channel (UHF 36). (☞ pg. 3)</p> <p>If you are using the AV connection, set the TV to its AV mode.</p>
2. Noise appears during visual search.	<ul style="list-style-type: none"> This is normal. 	
3. Noise appears during normal playback.	<ul style="list-style-type: none"> The automatic tracking mode is engaged. 	Try manual tracking. (☞ pg. 11)
4. Noise appears during slow-motion playback.	<ul style="list-style-type: none"> The automatic tracking mode is engaged. 	Try manual tracking. (☞ pg. 11)
5. Noise appears during still playback.		Press PAUSE a few times to remove the noise bars from the screen.
6. The playback picture is blurred or interrupted while TV broadcasts are clear.	<ul style="list-style-type: none"> The video heads may be dirty. 	Consult your JVC dealer.
RECORDING		
SYMPTOM	POSSIBLE CAUSE	CORRECTIVE ACTION
1. Recording cannot be started.	<ul style="list-style-type: none"> There is no cassette loaded, or the cassette loaded has had its Record Safety tab removed. 	Insert a cassette, or using adhesive tape, reseal the slot where the tab was removed.
2. TV broadcasts cannot be recorded.	<ul style="list-style-type: none"> "AU" has been selected as the input mode. 	Set to the desired channel.

3. Tape-to-tape editing is not possible.	<ul style="list-style-type: none"> • The source (another video recorder, camcorder) has not been properly connected. • All necessary power switches have not been turned on. • The input mode is not correct. 	<p>Confirm that the source is properly connected.</p> <p>Confirm that all units' power switches are turned on. Set the input mode to "AU".</p>
4. Camcorder recording is not possible.	<ul style="list-style-type: none"> • The camcorder has not been properly connected. • The input mode is not correct. 	<p>Confirm that the camcorder is properly connected. Set the input mode to "AU".</p>

TIMER RECORDING

SYMPTOM	POSSIBLE CAUSE	CORRECTIVE ACTION
1. Timer recording won't work.	<ul style="list-style-type: none"> • The clock and/or the timer have been set incorrectly. • The timer is not engaged. 	<p>Re-perform the clock and/or timer settings. Press TIMER and confirm that "Ⓣ" is displayed on the display panel.</p>
2. On-screen timer programming is not possible.	<ul style="list-style-type: none"> • Timer recording is in progress. 	<p>Timer programming can't be performed while a timer recording is in progress. Wait until it finishes.</p>
3. "Ⓣ" and "Ⓣ" on the display panel won't stop blinking.	<ul style="list-style-type: none"> • The timer is engaged but there's no cassette loaded. 	<p>Load a cassette with the Record Safety tab intact, or cover the hole using adhesive tape.</p>
4. The cassette is automatically ejected, and "Ⓣ" and "Ⓣ" on the display panel won't stop blinking.	<ul style="list-style-type: none"> • The loaded cassette has had its Record Safety tab removed. 	<p>Remove the cassette and cover the hole with adhesive tape, or insert a cassette with the Record Safety tab intact.</p>
5. "Ⓣ" blinks for 10 seconds and the Timer mode is disengaged.	<ul style="list-style-type: none"> • TIMER has been pressed when there are no programs in memory, or the timer record information has been programmed incorrectly. 	<p>Check the programmed data and re-program as necessary, then press TIMER again.</p>
6. The cassette is automatically ejected, the power shuts off and "Ⓣ" and "Ⓣ" won't stop blinking.	<ul style="list-style-type: none"> • The end of the tape was reached during timer recording. 	<p>The programme may not have been recorded in its entirety. Next time make sure you have enough time on the tape to record the entire programme.</p>
7. ShowView does not timer-record properly.	<ul style="list-style-type: none"> • The recorder's channel positions have been set incorrectly. 	<p>Refer to "Guide Prog. Number Set" and re-perform the procedure (Ⓞ pg. 19).</p>

OTHER PROBLEMS

SYMPTOM	POSSIBLE CAUSE	CORRECTIVE ACTION
1. Whistling or howling is heard from the TV during camcorder recording.	<ul style="list-style-type: none"> • The camcorder's microphone is too close to the TV. • The TV's volume is too high. 	<p>Position the camcorder so its microphone is away from the TV. Turn the TV's volume down.</p>
2. When scanning channels, some of them are skipped over.	<ul style="list-style-type: none"> • Those channels have been designated to be skipped. 	<p>If you need the skipped channels, restore them (Ⓞ pg. 29).</p>
3. The channel cannot be changed.	<ul style="list-style-type: none"> • Recording is in progress. 	<p>Press PAUSE to pause the recording, change channels, then press PLAY to resume recording.</p>
4. The remote control won't operate the TV.	<ul style="list-style-type: none"> • The TV/VCR switch is in the wrong position. 	<p>Set the switch to TV.</p>
5. Channel settings that were made manually seem to have changed or disappeared.	<ul style="list-style-type: none"> • After the manual settings were made, Auto Channel Set was performed. 	<p>Perform manual setting again.</p>



PLAYBACK

- Q. What happens if the end of the tape is reached during playback or search?**
A. The tape is automatically rewound to the beginning.
.....
- Q. Can the video recorder indefinitely remain in the still mode?**
A. No. It stops automatically after 5 minutes to protect the heads.
.....
- Q. During search, slow, still and frame-by-frame playback, I can't hear any audio. What's the problem?**
A. This is normal.
.....
- Q. When returning from multi-speed search to normal playback, the picture is disturbed. Should I be concerned about this?**
A. No, it is normal.
.....
- Q. Noise bars appear during multi-speed search. What's the problem?**
A. This is normal.
.....
- Q. Other than preventing further recording, what effect does removing the Record Safety tab have?**
A. It disables marking of index codes.
.....
- Q. Sometimes, during Index Search, the video recorder can't find the programme I want to see. Why not?**
A. There may be index codes too close together.
.....

RECORDING

- Q. When I pause and then resume a recording, the end of the recording before the pause is overlapped by the beginning of the continuation of recording. Why does this happen?**
A. This is normal. It reduces distortion at the pause and resume points.
.....
- Q. Can the video recorder indefinitely remain in the Record-Pause mode?**
A. No. The video recorder goes to its Stop mode automatically after 5 minutes to protect the heads.
.....
- Q. What happens if the tape runs out during recording?**
A. The video recorder automatically rewinds it to the beginning.
.....

TIMER RECORDING

- Q. "⊙" and "⊖" remain lit on the display panel. Is there a problem?**
A. No. This is a normal condition for a timer recording in progress.
.....
- Q. Can I program the timer while I'm watching a tape or a TV broadcast?**
A. You won't see the picture as it is replaced by the on-screen menu, but the audio from the program or tape you're viewing can be heard.
.....

ATTENTION:

This recorder contains microcomputers. External electronic noise or interference could cause malfunctioning. In such cases, switch the recorder off and unplug the mains power cord. Then plug it in again and turn the recorder on. Take out the cassette. After checking the cassette, operate the unit as usual.



SPECIFICATIONS

35

GENERAL

Power requirement	: AC 220 – 240 V~, 50/60 Hz
Power consumption	: 20 W
Temperature	
Operating	: 5°C to 40°C
Storage	: -20°C to 60°C
Operating position	: Horizontal only
Dimensions (WxHxD)	: 400 x 94 x 340 mm
Weight	: 4.3 kg
Format	: VHS PAL standard
Maximum recording time	
(SP)	: 240 min. with E-240 video cassette
(LP) [J438E only]	: 480 min. with E-240 video cassette

VIDEO/AUDIO

Signal system	: PAL-type colour signal and CCIR monochrome signal, 625 lines/50 fields
Recording system	: DA4 (Double Azimuth) head helical scan system (HR-J438E) Rotary two-head helical scan system (HR-J238E)
Signal-to-noise ratio	: 45 dB
Horizontal resolution	: 250 lines
Frequency range	: 70 Hz to 10,000 Hz
Input/Output	: 21-pin scart connector x 2 (IN/OUT x 1, IN/DECODER x 1) RCA connector x 1 (IN x 1) [J438E only]

TUNER/TIMER

TV channel storage capacity	: 99 positions (+AUX position "AU")
Tuning system	: Frequency synthesized tuner
Channel coverage	: VHF 47 – 89/104 – 300/ 302 – 470MHz UHF 470 – 862MHz
Aerial output	: UHF channel 36 (Adjustable 32 – 40)
Memory backup time	: Approx. 60 min.

ACCESSORIES

Provided accessories	: RF cable, Infrared remote control unit, "R6" battery x 2
----------------------	--

*Specifications shown are for SP mode unless otherwise specified.
E. & O.E. Design and specifications subject to change without notice.*

List Of Terms

This guide serves as a quick way to locate frequently used terms and on-screen display names. The first page on which the term appears is listed. Most terms appear more than once in the instruction manual.

A

A/B Code Switch	pg. 13
A-Code Signals	pg. 13
Aerial	pg. 3
Audio Dubbing	pg. 25
Auto Channel Set	pg. 5
Auto Clock Set	pg. 7
Auto SP/LP Timer	pg. 24
AUX	pg. 20
AV	pg. 3
AV Connection	pg. 3

B

B-Code Signals	pg. 13
B.E.S.T. (Biconditional Equalised Signal Tracking)	pg. 15

C

Cancel	pg. 20
Cassette Adapter	pg. 9
Channel Set Mode Menu	pg. 5
Clock	pg. 7
Clock Set	pg. 7
Contents	pg. 1
Counter Memory	pg. 13
Counter Reset	pg. 13
Country	pg. 5

D

Daily	pg. 22
Delete A Channel	pg. 29
Display Panel	pg. 38

E

Editing	pg. 25
---------------	--------

F

Fine Tuning	pg. 30
Frame-By-Frame Playback	pg. 10
Front View	pg. 37

G

Guide Prog. Number	pg. 19
--------------------------	--------

H

Head Cleaning	pg. 2
High-Seed Search	pg. 10

I

Index Code	pg. 12
Index Search	pg. 12
Instant ReView	pg. 11
Instant Timer Recording (ITR)	pg. 18

J

Just Clock	pg. 7
Jog Dial	pg. 10

L

Language	pg. 5
Load A Cassette	pg. 9

M

Manual Channel Set	pg. 29
Manual Clock Set	pg. 8
Manual Tracking	pg. 11
Moisture Condensation	pg. 2
Multi-Brand Remote (MBR) Control Setting	pg. 28

N

Next-Function Memory	pg. 12
NTSC Playback	pg. 11

O

On-Screen (O.S.D.)	pg. 17
--------------------------	--------

P

Programme Delivery Control (PDC) Playback	pg. 24
Programme Screen	pg. 9
Programme Screen	pg. 23

R

Rear View	pg. 37
Record Safety Tab	pg. 14
Recording	pg. 14
Repeat Playback	pg. 11
RF Connection	pg. 3

S

Scart Connector	pg. 3
Scene Finder	pg. 12
ShowView	pg. 19
Shuttle Ring	pg. 10
Slow Motion	pg. 10
Specifications	pg. 35
Still Picture	pg. 10

T

Tape Position Indicator	pg. 12
Tape Speed	pg. 14
Timer Programming	pg. 23
Timer Recording	pg. 19
Timer Warning	pg. 24
Tracking	pg. 11
Tuner	pg. 5
TV Brand	pg. 28

V

Variable-Speed Search	pg. 10
Video Programme System (VPS)	pg. 24

W

Weekly	pg. 22
--------------	--------

FRONT VIEW

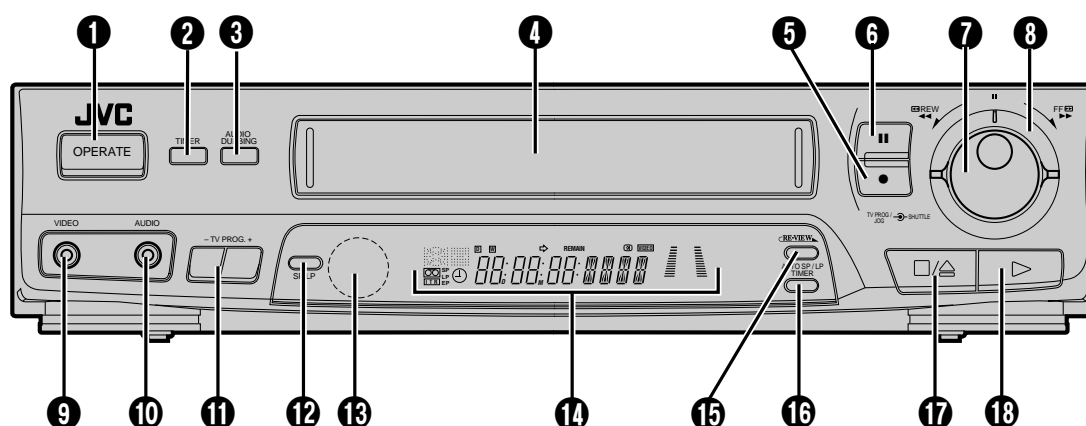

*Remove the cap to use the front panel connectors.

- | | |
|--|--|
| 1 OPERATE Button (☞ pg. 5) | 10 AUDIO Input Connector [J438E only] (☞ pg. 25) |
| 2 TIMER Button (☞ pg. 22) | 11 TV PROG. +/- Buttons (☞ pg. 5) |
| 3 AUDIO DUBBING Button [J438E] (☞ pg. 25)
COUNTER RESET Button [J238E] (☞ pg. 13) | 12 SP/LP [Tape Speed] Button [J438E only] (☞ pg. 14) |
| 4 Cassette Loading Slot | 13 Infrared Beam Receiving Window |
| 5 RECORD Button (☞ pg. 14) | 14 Display Panel (☞ pg. 38) |
| 6 PAUSE Button (☞ pg. 10) | 15 REVIEW Button (☞ pg. 11) |
| 7 TV PROG. Dial (☞ pg. 14)
JOG Dial [J438E only] (☞ pg. 10) | 16 AUTO SP/LP TIMER Button [J438E only] (☞ pg. 24) |
| 8 SHUTTLE Ring (☞ pg. 10) | 17 STOP/EJECT Button (☞ pg. 9) |
| 9 VIDEO Input Connector [J438E only] (☞ pg. 27) | 18 PLAY Button (☞ pg. 9) |

REAR VIEW

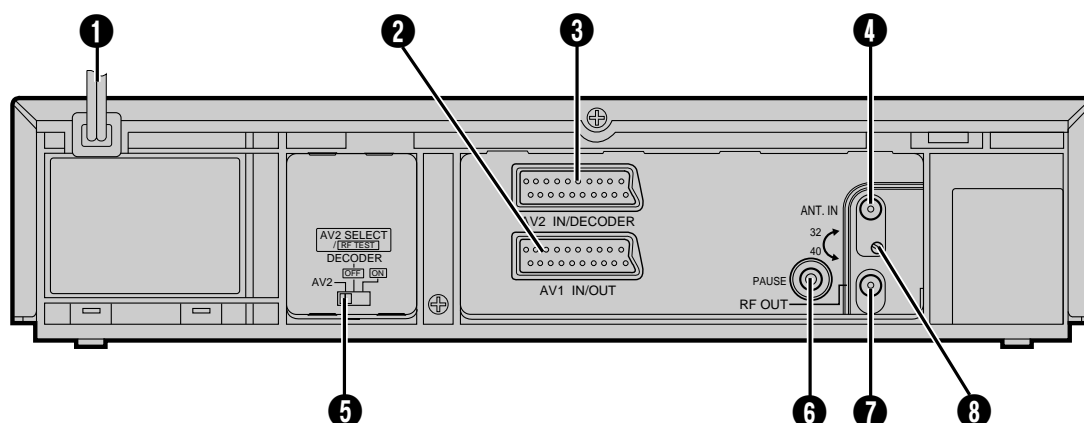

- | | |
|---------------------------------------|--|
| 1 Mains Power Cord (☞ pg. 3) | 6 Remote PAUSE Connector [J438E only] (☞ pg. 27) |
| 2 AV1 IN/OUT Connector (☞ pg. 3) | 7 RF OUT Connector (☞ pg. 3) |
| 3 AV2 IN/DECODER Connector (☞ pg. 4) | 8 RF Output Channel Adjustment Screw (☞ pg. 4) |
| 4 ANT. IN Connector (☞ pg. 3) | |
| 5 AV2 SELECT/RF TEST Switch (☞ pg. 4) | |



DISPLAY PANEL

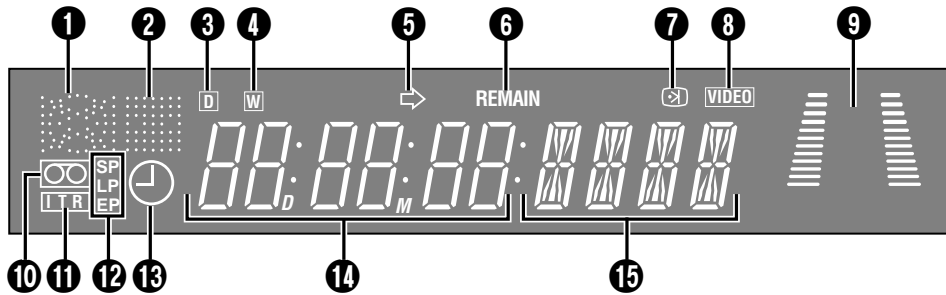

1 and 2 Symbolic Mode Indicators

PLAY:		STILL: FORWARD SLOW:	
FF:		STILL: REVERSE SLOW:	
REW:		RECORD:	
FF VARIABLE SHUTTLE SEARCH:		RECORD PAUSE:	
REW VARIABLE SHUTTLE SEARCH:		AUDIO DUBBING: **	
REVERSE PLAY:		AUDIO DUBBING PAUSE: **	

* The indicator will blink during turbo search.
** J438E only

- 3 "DAILY" Program Mark (pg. 22)
- 4 "WEEKLY" Program Mark (pg. 22)
- 5 Start Time/Stop Time Indicator (pg. 21)
- 6 Tape Remaining Time Indicator (pg. 13)
- 7 PDC/VPS Indicator (pg. 24)
- 8 VIDEO Indicator (pg. 5)
- 9 B.E.S.T. Picture System Display (pg. 15)
- 10 "Cassette Loaded" Mark
- 11 Instant Timer Recording (pg. 18)
- 12 Tape Speed Indicators [J438E only] (pg. 14)
- 13 "Timer" Indicator (pg. 22)
- 14 Clock/Counter/Tape Remaining Time Display (pg. 7)
- 15 Channel/Mode Display (pg. 5)

REMOTE CONTROL

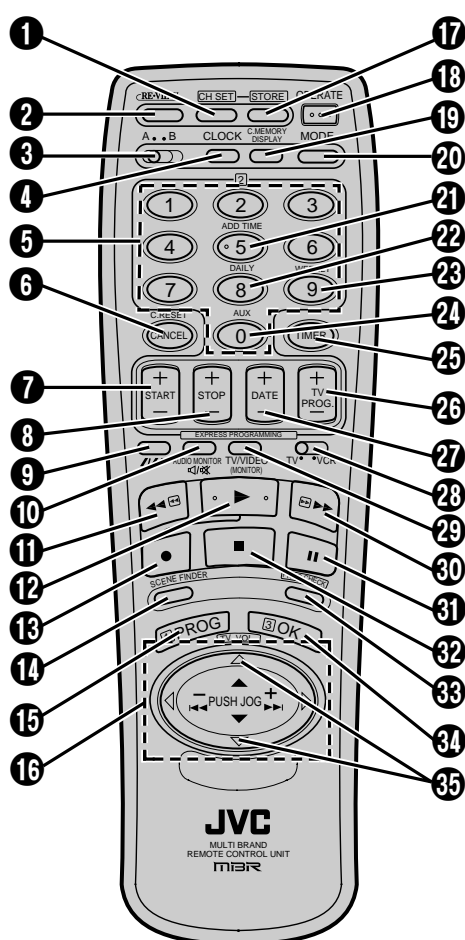

- 1 CH SET Button (pg. 5)
- 2 REVIEW Button (pg. 11)
- 3 A/B CODE Switch (pg. 13)
- 4 CLOCK Button (pg. 7)
- 5 NUMBER Keys (pg. 14)
- 6 CANCEL Button (pg. 20)
- 7 C.RESET Button (pg. 13)
- 8 START +/- Button (pg. 23)
- 9 STOP +/- Button (pg. 23)
- 10 SP/LP Button (pg. 11)
- 11 DIGIT ENTRY Button (pg. 28)
- 12 TV MUTE Button (pg. 28)
- 13 Rewind [REW] Button (pg. 9)
- 14 PLAY Button (pg. 9)
- 15 RECORD Button (pg. 14)
- 16 SCENE FINDER Button (pg. 12)
- 17 PROG Button (pg. 21)
- 18 PUSH JOG $\Delta \nabla \triangleleft \triangleright$ Button (pg. 5)
- 19 PUSH JOG $\triangleleft \triangleright$ Button (pg. 10)
- 20 STORE Button (pg. 29)
- 21 C.MEMORY Button (pg. 13)
- 22 OPERATE Button (pg. 5)
- 23 DISPLAY Button (pg. 13)
- 24 MODE Button (pg. 15)
- 25 ADD TIME Button (pg. 22)
- 26 DAILY Button (pg. 22)
- 27 WEEKLY Button (pg. 22)
- 28 AUX Button (pg. 25)
- 29 TIMER Button (pg. 22)
- 30 TV PROG. +/- Button (pg. 5)
- 31 DATE +/- Button (pg. 23)
- 32 TV/VCR Switch (pg. 28)
- 33 TV/VIDEO Button (pg. 5)
- 34 Fast Forward [FF] Button (pg. 9)
- 35 PAUSE Button (pg. 10)
- 36 STOP Button (pg. 9)
- 37 PROG CHECK Button (pg. 24)
- 38 OK Button (pg. 5)
- 39 TV VOL $\Delta \nabla$ Button (pg. 28)

Installing Batteries

- 1 Open the battery compartment cover.
- 2 Insert 2 "R6"-size batteries (provided) in the correct directions.
- 3 Replace the cover.

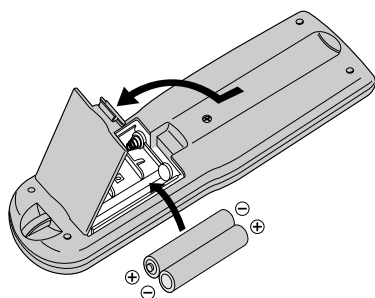

How To Use

The remote control can operate most of your video recorder's functions, as well as basic functions of TV sets of JVC and other brands (pg. 28).

- Point the remote control toward the sensor window.
- The maximum operating distance of the remote control is about 8 m.

NOTE:

If for some reason the remote control doesn't work properly, remove its batteries, wait a short time and then try again.



EN

HR-J438E/238E

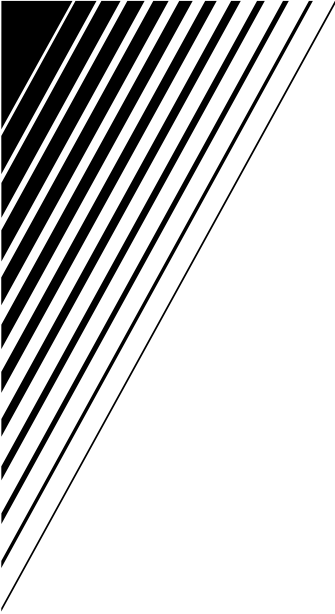

JVC

VICTOR COMPANY OF JAPAN, LIMITED

COPYRIGHT © 1996 VICTOR COMPANY OF JAPAN, LTD.

 Printed in Japan
0396YOV*UN*VP



Free Manuals Download Website

<http://myh66.com>

<http://usermanuals.us>

<http://www.somanuals.com>

<http://www.4manuals.cc>

<http://www.manual-lib.com>

<http://www.404manual.com>

<http://www.luxmanual.com>

<http://aubethermostatmanual.com>

Golf course search by state

<http://golfingnear.com>

Email search by domain

<http://emailbydomain.com>

Auto manuals search

<http://auto.somanuals.com>

TV manuals search

<http://tv.somanuals.com>