

# JVC



## VIDEO CASSETTE RECORDER

HR-S5965EK

HR-S5966EK

HR-S5967EK

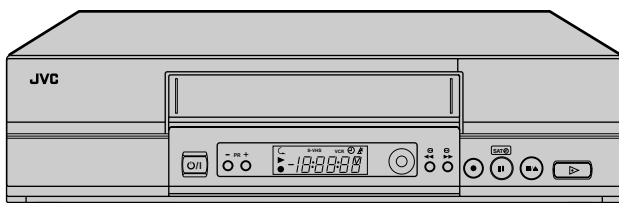

**SVHS**  
625

*Super VHS ET*

*Hi-Fi*

**VIDEO** *Plus+*

## INSTRUCTIONS

LPT0768-001B

# Safety Precautions

The rating plate and the safety caution are on the rear of the unit.

**WARNING: DANGEROUS VOLTAGE INSIDE**

**WARNING: TO PREVENT FIRE OR SHOCK HAZARD, DO NOT EXPOSE THIS UNIT TO RAIN OR MOISTURE.**

## IMPORTANT

- Please read the various precautions on pages 2–4 of this instruction manual before installing or operating the recorder.
- It should be noted that it may be unlawful to re-record pre-recorded tapes, records, or discs without the consent of the owner of copyright in the sound or video recording, broadcast or cable programme and in any literary, dramatic, musical, or artistic work embodied therein.

## IMPORTANT

**Connection to the mains supply in the United Kingdom. DO NOT cut off the mains plug from this equipment.** If the plug fitted is not suitable for the power points in your home or the cable is too short to reach a power point, then obtain a proper safety approved extension lead/adaptor or consult your dealer.

**In the unlikely event of the plug fuse failing be sure to replace the fuse only with an identical approved type, as originally fitted, and to replace the fuse cover. If the fuse fails again consult your nearest JVC dealer.**

If nonetheless the mains plug is cut off remove the fuse and dispose of the plug immediately, to avoid a possible shock hazard by inadvertent connection to the mains supply.

If this product is not supplied fitted with a mains plug then follow the instructions given below:

**DO NOT** make any connection to the Larger Terminal coded E or Green.

The wires in the mains lead are coloured in accordance with the following code:

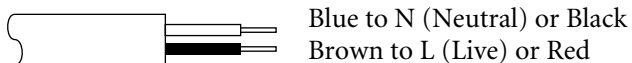

If these colours do not correspond with the terminal identifications of your plug, connect as follows:



Blue wire to terminal coded N (Neutral) or coloured Black.

Brown wire to terminal coded L (Live) or coloured Red.

***If in doubt — consult a competent electrician.***

## CAUTION

- When you are not using the recorder for a long period of time, it is recommended that you disconnect the power cord from the mains outlet.
- Dangerous voltage inside. Refer internal servicing to qualified service personnel. To prevent electric shock or fire hazard, remove the power cord from the mains outlet prior to connecting or disconnecting any signal lead or aerial.

The **STANDBY/ON**  button does not completely shut off mains power from the unit, but switches operating current on and off. “” shows electrical power standby and “” shows **ON**.

Video tapes recorded with this video recorder in the LP (Long Play) mode cannot be played back on a single-speed video recorder.

When the equipment is installed in a cabinet or a shelf, make sure that it has sufficient space on all sides to allow for ventilation (10 cm or more on both sides, on top and at the rear.)

When discarding batteries, environmental problems must be considered and the local rules or laws governing the disposal of these batteries must be followed strictly.

Failure to heed the following precautions may result in damage to the recorder, remote control or video cassette.

1. **DO NOT place the recorder...**
  - ... in an environment prone to extreme temperatures or humidity.
  - ... in direct sunlight.
  - ... in a dusty environment.
  - ... in an environment where strong magnetic fields are generated.
  - ... on a surface that is unstable or subject to vibration.
2. **DO NOT block the recorder's ventilation openings or holes.**  
(If the ventilation openings or holes are blocked by a newspaper or cloth, etc., the heat may not be able to get out.)
3. **DO NOT place heavy objects on the recorder or remote control.**
4. **DO NOT place anything which might spill on top of the recorder or remote control.**  
(If water or liquid is allowed to enter this equipment, fire or electric shock may be caused.)
5. **DO NOT expose the apparatus to dripping or splashing.**
6. **DO NOT use this equipment in a bathroom or places with water.** Also **DO NOT** place any containers filled with water or liquids (such as cosmetics or medicines, flower vases, potted plants, cups, etc.) on top of this unit.
7. **DO NOT place any naked flame sources, such as lighted candles, on the apparatus.**
8. **AVOID violent shocks to the recorder during transport.**

## MOISTURE CONDENSATION

Moisture in the air will condense on the recorder when you move it from a cold place to a warm place, or under extremely humid conditions—just as water droplets form in the surface of a glass filled with cold liquid. Moisture condensation on the head drum will cause damage to the tape. In conditions where condensation may occur, keep the recorder turned on for a few hours to let the moisture dry.

### ATTENTION

#### TO MOBILE PHONE USERS:

Using a mobile phone in the vicinity of the recorder may cause picture vibration on the TV screen or change the screen to a blue back display.

#### ON PLACING THE RECORDER:

Some TVs or other appliances generate strong magnetic fields. Do not place this appliance on top of the recorder as it may cause picture disturbance.

#### Caution on Replaceable lithium battery

The battery used in this device may present a fire or chemical burn hazard if mistreated. Do not recharge, disassemble, heat above 100°C or incinerate.

Replace battery with CR2032. Panasonic (Matsushita Electric) or Maxell is recommended.

Danger of explosion or Risk of fire if the battery is incorrectly replaced.

- Dispose of used battery promptly.
- Keep away from children.
- Do not disassemble and do not dispose of in fire.



- Cassettes marked “S-VHS” and “VHS” can be used with this video cassette recorder. However, S-VHS recordings are possible only with cassettes marked “S-VHS”.  
By using the S-VHS ET function, it is possible to record and play back with S-VHS picture quality on VHS cassettes with this recorder.
- VIDEO Plus+ and PlusCode are registered trademarks of Gemstar Development Corporation. The VIDEO Plus+ system is manufactured under license from Gemstar Development Corporation.

# Some Do's And Don'ts On The Safe Use Of Equipment

This equipment has been designed and manufactured to meet international safety standards but, like any electrical equipment, care must be taken if you are to obtain the best results and safety is to be assured.

- DO** read the operating instructions before you attempt to use the equipment.
- DO** ensure that all electrical connections (including the mains plug, extension leads and interconnections between pieces of equipment) are properly made and in accordance with the manufacturer's instructions. Switch off and withdraw the mains plug when making or changing connections.
- DO** consult your dealer if you are ever in doubt about the installation, operation or safety of your equipment.
- DO** be careful with glass panels or doors on equipment.
- DON'T** continue to operate the equipment if you are in any doubt about it working normally, or if it is damaged in any way — switch off, withdraw the mains plug and consult your dealer.
- DON'T** remove any fixed cover as this may expose dangerous voltages.
- DON'T** leave equipment switched on when it is unattended unless it is specifically stated that it is designed for unattended operation or has a standby mode. Switch off using the switch on the equipment and make sure that your family knows how to do this. Special arrangements may need to be made for infirm or handicapped people.
- DON'T** use equipment such as personal stereos or radios so that you are distracted from the requirements of road safety. It is illegal to watch television whilst driving.
- DON'T** listen to headphones at high volume, as such use can permanently damage your hearing.
- DON'T** obstruct the ventilation of the equipment, for example with curtains or soft furnishings. Overheating will cause damage and shorten the life of the equipment.
- DON'T** use makeshift stands and NEVER fix legs with wood screws — to ensure complete safety always fit the manufacturer's approved stand or legs with the fixings provided according to the instructions.
- DON'T** allow electrical equipment to be exposed to rain or moisture.

## ABOVE ALL...

- **NEVER** let anyone especially children push anything into holes, slots or any other opening in the case — this could result in a fatal electrical shock;
- **NEVER** guess or take chances with electrical equipment of any kind — it is better to be safe than sorry!

# Contents

<b>Diagrams of Equipment .....</b>	<b>6</b>
<b>Equipment Key .....</b>	<b>7</b>
<b>Welcome to JVC .....</b>	<b>8</b>
<b>Three-Step Quick Start.....</b>	<b>10</b>
<b>Basic Features .....</b>	<b>13</b>
<b>Advanced Features .....</b>	<b>27</b>
<b>Subsidiary Information .....</b>	<b>53</b>
<b>List of Terms .....</b>	<b>57</b>

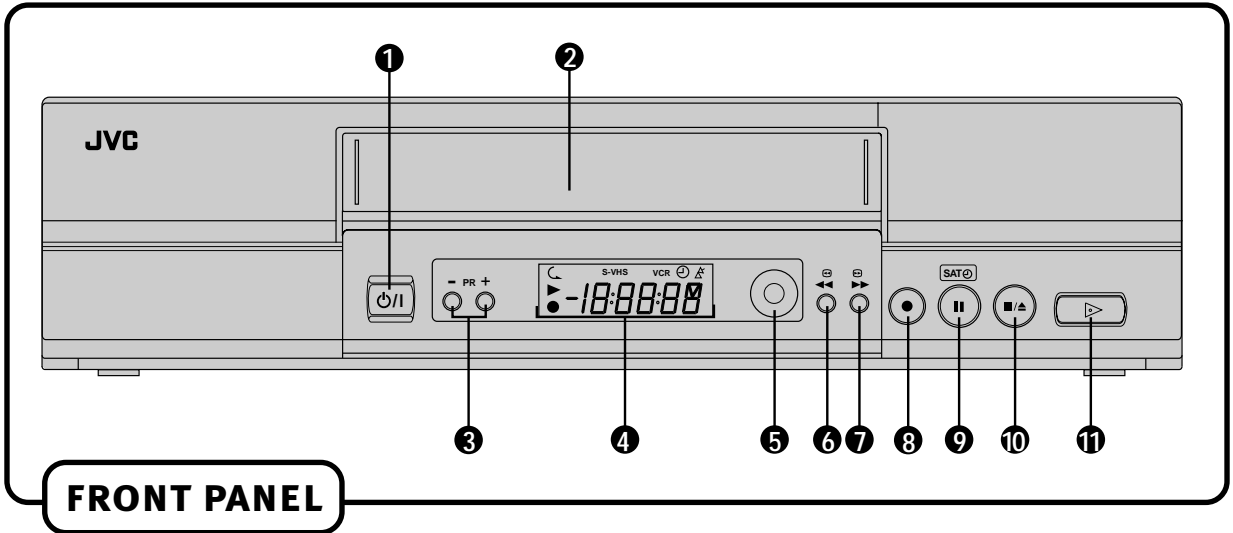

**FRONT PANEL**

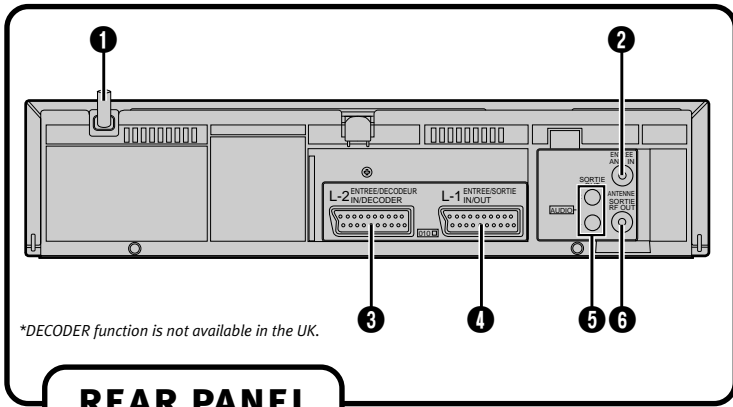

**REAR PANEL**

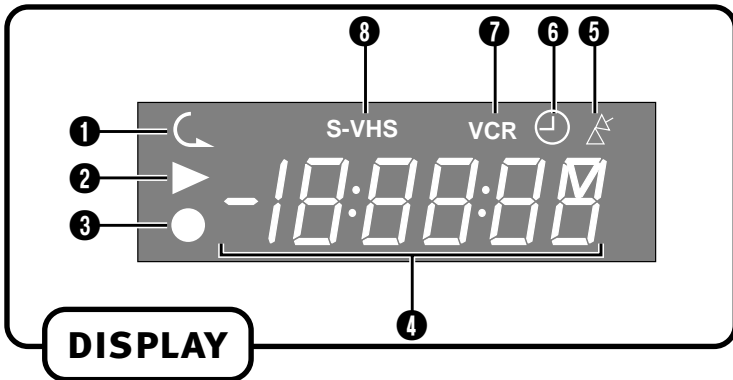

**DISPLAY**

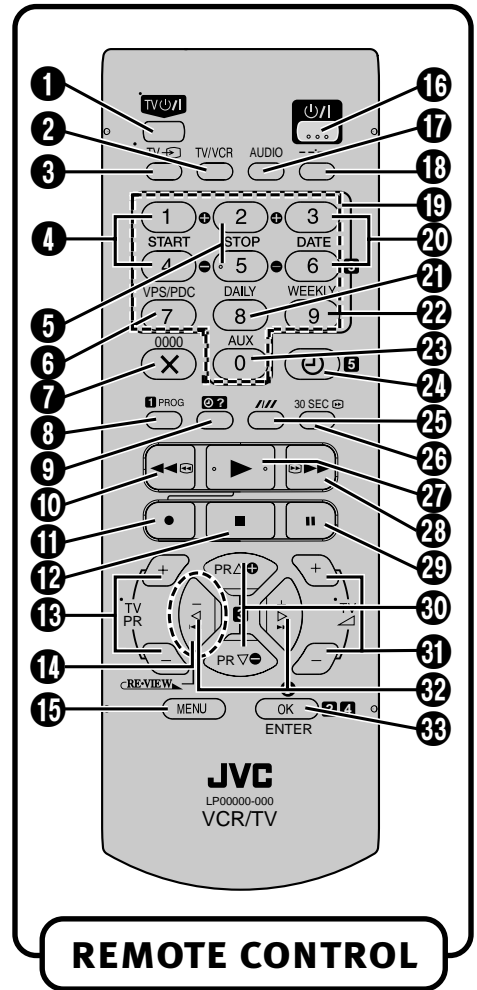

**REMOTE CONTROL**

# Diagram Key

## FRONT PANEL

- STANDBY/ON** Button turns VCR on/off (loading a cassette also turns power on).
- Cassette Loading Slot** is where cassette is inserted; door closes.
- PR+/-** Button selects a preset position.
- Display Panel** provides clear view of various displays and indicators.
- Infrared Beam Receiving Window** is where Remote Control should be aimed when in use.
- Button rewinds the tape; initiates high-speed reverse search.
- Button fast-forwards tape; initiates high-speed forward search.
- Button starts regular recording (press once), Instant Timer Recording (press twice); sets duration of ITR.
- Button stops tape temporarily during recording; stops tape temporarily during playback; plays back frame by frame with each additional press.
- SAT** Button enables/disables the Auto Satellite Programme Recording mode.
- Button stops tape; ejects tape during Stop mode.
- Button plays back tape; cancels Pause, Still, Slow, Search modes.

## REAR PANEL

- Mains Power Cord** supplies power to VCR.
- ANT. IN Connector** enables connection of aerial.
- L-2 IN/DECODER Connector** enables connection of satellite receiver or second recorder.  
\* DECODER function is not available in the UK.
- L-1 IN/OUT Connector** enables AV connection to TV or second VCR.
- AUDIO OUT (L/R) Connectors** enable connection of audio cassette recorder, TV or second VCR for dubbing.

- RF. OUT Connector** enables connection to aerial terminal of TV receiver.

## VCR DISPLAY PANEL

- Indicator blinks after timer-recording and shows how many programmes have been timer-recorded.
- Play Indicator** lights up during playback; blinks during Repeat Playback or when using Next Function Memory for playback.
- Record Indicator** lights up during recording; blinks during Instant Timer Recording.
- Channel Display** shows preset position where the station currently being received is stored.

**Mode** shows external input mode selected (L-1 or L-2)

**Clock Display** shows current time.

Preset Position\* (or Mode) and Clock Display appear alternately when ---:--- is pressed.

\* *Preset Position (or Mode) is not displayed during playback.*

- Indicator lights up during Auto Satellite Programme Recording standby model; blinks when Auto Satellite Programme Recording in progress.
- Indicator lights when the button has been pressed to engage Timer mode.
- VCR Indicator** lights when the VCR is in the video mode. At this point, the TV automatically enters AV mode.
- S-VHS Indicator** lights when a cassette marked S-VHS is inserted with S-VHS mode set to 'ON', when an S-VHS-recorded tape or S-VHS ET-recorded tape is played back, or when S-VHS ET mode is engaged.

## REMOTE CONTROL

- TV STANDBY/ON** Button turns TV on/off.
- TV/VCR Button** switches connected TV's mode between TV and AV.
- TV** Button switches TV input terminal.
- START** Button accesses Regular Program screen; inputs programme Start Time.
- STOP** Button inputs programme Stop Time.
- PDC Button** enables/disables PDC recording.  
\* VPS (Video Programme System) recording is not currently available in the U.K. and not possible with this VCR.
- X Button** cancels timer-programme.

**oooo Button** resets counter on the on-screen display to '0:00:00'.

- PROG Button** accesses Timer Programming Set screen.
- Button accesses Program screens/displays to check the programme that you have programmed (next programme's information screen appears each time button is pressed).
- Button — same as button on VCR.
- Button starts regular recording (press the same time).
- Button stops tape.
- TV PR +/- Buttons** select the connected JVC TV's channel.
- REVIEW** Button 'reviews' timer-recorded programme.
- Button accesses Menu screen.

- STANDBY/ON** Button — same as button on VCR.
- AUDIO Button** changes output sound mode.
- :---** (Display) Button switches display between clock time and Preset Position\* (or Mode).  
Preset Position (or Mode) is not displayed during playback.

- Number Keys** are used in preset position selection and the VIDEO Plus+ Timer Programming.
- DATE** Button inputs date of programme for timer recording
- DAILY Button** enables timer recording of daily serials.
- WEEKLY Button** enables timer recording of weekly serials.
- AUX Button** selects VCR's auxiliary input mode.
- Button engages timer-standby mode.
- Auto Tracking Button** enables/disables auto tracking mode during playback.
- Button selects tape speed.
- 30 SEC** Button initiates a 30-second period of fast-motion playback.
- Button — same as button on VCR.
- Button — same as button on VCR.
- Button — same as button on VCR.
- Buttons are used for selection in on-screen menus.

- PR** Buttons select a preset position.
- TV** +/- Buttons control volume of connected JVC TV.
- Buttons initiate functions such as Index Search, variable-speed search, frame by frame playback.
- Button enters selections made in on-screen menus.

Button — Shows current VCR status on the TV screen if O.S.D is set to ON.

**BEFORE YOU START**

Please read the **SAFETY FIRST** on pages 2-4 it tells you about some safety points

Refer to the diagrams on pages 6-7 when reading through these instructions

Refer to the **List of Terms** on page 57 if you need an explanation for any terms in this manual

**REMOTE CONTROL**

The Remote Control can operate most of your VCR's functions, as well as basic functions of JVC TV sets. (see page 7)

When inserting the lithium battery -CR 2032-, be sure to insert in the correct directions as indicated below.

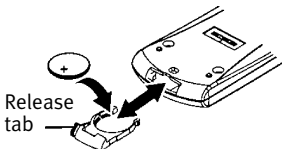

To open the battery compartment, press the release tab and carefully, pull the compartment out.

Depending on the type of JVC TV. Some or all functions cannot be operated using the Remote Control.

If the Remote Control doesn't work properly, remove it's battery, replace the battery and then try again.again.

# Welcome to JVC

## Thank you for choosing JVC.

### We hope that you will get many hours of enjoyment from your new unit.

In just three easy steps you will be ready to enjoy the exceptional performance of your new VCR. More detailed instructions begin on page 10. They will explain how to use the many sophisticated features this VCR boasts.



## Getting Everything Ready

**CHECK THE CONTENTS** Unpack the box and place the VCR on a flat, stable surface. Check that you have the items shown below.

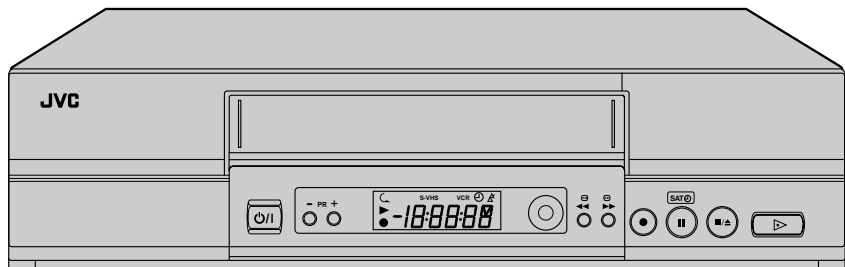

Video Cassette Recorder



RF Cable



Lithium Battery -CR 2032-

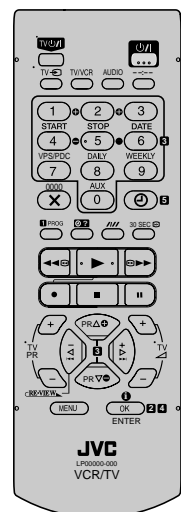

Infrared Remote Control Unit



**GETTING EVERYTHING READY (continued)**

**CONNECT CABLES** Connect the cables as indicated in the diagram (below), using the TV Aerial Cable, the RF Cable and the 21-pin SCART Cable (not provided).

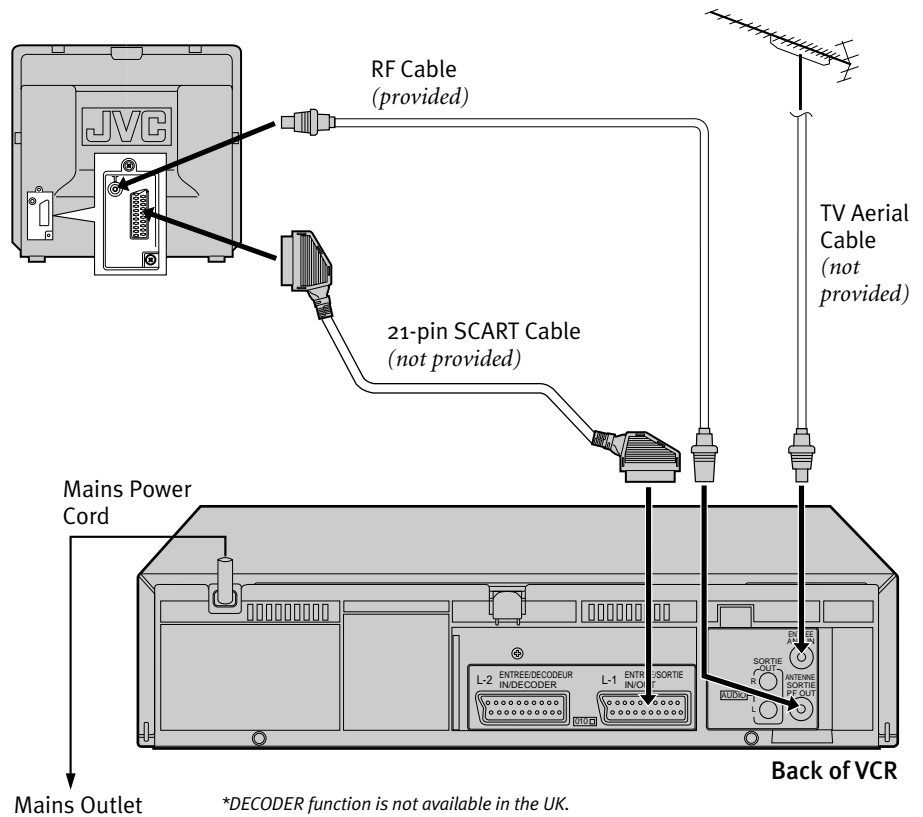
**SCART AND RF**

SCART is a recommended option because its use improves the quality of the picture. If connecting to a stereo TV you will need a SCART cable. There are several types of SCART cables, fully-wired and others.

If you use a SCART cable, you must also connect the RF cable.

You are now ready to start the Three-Step Quick Start which begins on the next page.

# Three-Step Quick Start

## 1 2 3 Auto Setup

### BEFORE YOU START

Check that the VCR is turned off and no cassette is inserted

Load the battery into the Remote Control

Refer to the Remote Control diagram on pages 6–7

Unless indicated otherwise, use the buttons on the Remote Control

Check that the connection is completed

Turn on the TV

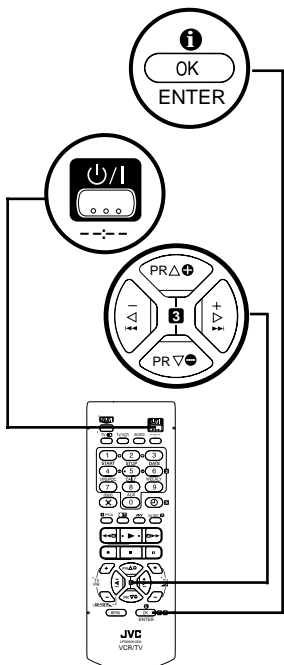

### START AUTO SETUP

Press the  $\odot/|$  button. If 'Auto' appears on the display panel, press **OK** (or  $\rightarrow$ ,  $\leftarrow$ ).

**WHAT WILL HAPPEN?** The display panel on the front of the VCR will show the word 'Auto'. Do not press any button on the VCR or the Remote Control.

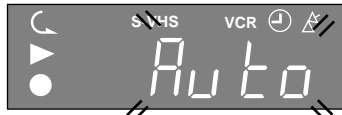

**Auto Setup is running:** don't touch any buttons

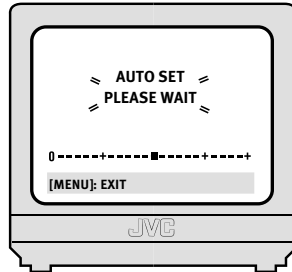

The VCR is automatically setting up the tuner channels, clock, the VIDEO Plus+ system assigned Guide Program numbers and the video channel. This only happens the first time that the VCR is turned on.

**RF AND SCART CONNECTION** If you have chosen to connect the VCR to the TV with both the RF Cable and a 21-pin SCART Cable (*not provided*) and the TV set is in its AV mode (see the TV manual), you will see the following information displayed on your TV screen:

**Your TV screen during Auto Setup if SCART is used**

### SELECT THE VIDEO CHANNEL

When **Auto Setup** has finished, you will see the following display panel on your VCR:

**RF CABLE ONLY** If you have only used the RF Cable to connect the VCR to the TV, you will see this display. The number is the channel on the TV that the **Auto Setup** has chosen to be the video channel. In the example, we have presumed that channel 52 is vacant and have set the VCR to 52:

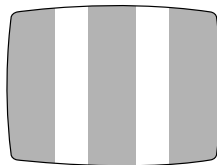
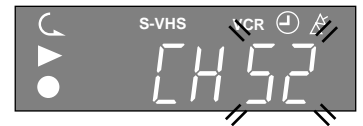

Now tune the TV set to channel 52 (*refer to TV manual if necessary*); you should see two vertical white bars appear on the TV screen. If the bars do not appear or are not clear, choose another vacant channel pressing **PR+**/ $\ominus$  on the Remote Control and try again. If you cannot obtain the vertical white bars on any channel between 22 and 69, consult your local JVC dealer.

**RF AND SCART CONNECTION** If you have chosen to connect the VCR to the TV with both the RF Cable and a 21-pin SCART Cable (*not provided*), you need to press the **PR-**/ $\ominus$  on the Remote Control until the figure reads '—'. This is because you will use the TV in AV mode to view video pictures and therefore do not need a dedicated video channel.



### FINISH AUTO SETUP

Press **OK** and move on to **Step 2** to check the results.

**OOPS!** If there is a power cut or you accidentally press a button during **Auto Setup**, turn the VCR off and then on again. Re-perform **Auto Setup**.

## 1 2 3 Check the Results

When **Auto Setup** finishes, you will see one of the three following examples on the VCR display panel:



**The Preset Positions and the Clock have been set successfully**

Go straight to **Step 3** (20:00 used as example only).



**The Preset Positions have been set successfully but the Clock has not**

Perform **Clock Set** on page 51.

Go to **Step 3**.



**Neither the Preset Positions or the Clock have been set successfully**

Make sure the cables are connected properly to the VCR and turn the VCR off and then on again. Try **Auto Set Up** again.

## 1 2 3 Finish Off

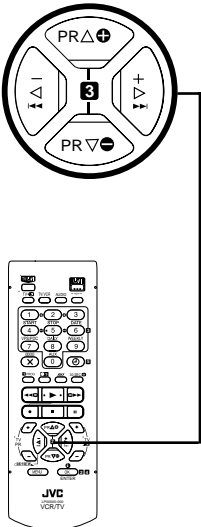

Select the Video channel or AV mode, then make sure that all necessary stations have been stored in the VCR's memory by using the **PRAB** and **PRVB** buttons. If station names (ID — [pg. 49](#)) have also been stored in the VCR's memory, the station name will be displayed at the top left corner of the TV screen for about 5 seconds each time you select a different channel via the VCR.

The VCR is now set up. You can now use it to play and record.

### IMPORTANT

- **RE-RUNNING SETUP** Auto Setup may not behave as described if it has already been run on the VCR. This is because some of the information gathered on the first Auto Setup- is retained in memory and that part of the process may be skipped by the VCR.
- **BAD RECEPTION** In certain reception conditions, station names may not be stored correctly, and **Guide Program Numbers** may not be set properly. If this happens, when you timer-record a TV programme using the VIDEO Plus+ system, the VCR will record a TV programme of a different station. When programming the timer using the VIDEO Plus+ system, be sure to check that the preset position corresponding to the broadcasting station you wish to record has been selected ([pg. 21](#), **VIDEO Plus+ Timer Programming**).
- **DUPLICATE STATIONS** You may be able to receive the same station from two different transmitters in which case Auto Setup will detect and store both. It is normal for one transmitter to give you a better quality picture than the other; to delete those stations which have a poor picture [Delete A Channel](#) on page 47.
- **MANUAL STATION SETTING** If any of the above problems occur, refer to pages 47 – 48 to input station names ([Change Station Name](#)). You can also change station preset positions ([Change Station Preset Position](#)).
- **RF CONNECTIONS** In certain reception conditions, the Video Channel may not be set correctly and interference may appear in the TV picture while the VCR's power is on. Set your Video Channel manually. ([pg. 44](#), **Video Channel Set**)

**IF YOU HAVE ANY DIFFICULTY WITH THE ABOVE PROCEDURES CALL THE JVC CUSTOMER SERVICE HOT LINE ON 0870 330 5000**



# Basic Features

<b>Playback.....</b>	<b>14</b>
<b>Playback Features .....</b>	<b>16</b>
<b>Recording .....</b>	<b>18</b>
<b>VIDEO Plus+® Timer Programming .....</b>	<b>21</b>
<b>Express Timer Programming .....</b>	<b>24</b>

# Playback

Playback is the most basic operation possible with your VCR. Audio-visual information recorded on a cassette will be played back on your TV screen just like a broadcast programme.

## 1 Load a Video Cassette

### BEFORE YOU START

Turn the TV on

Tune the TV to your Video Channel or to its AV mode

### NTSC TAPES

If an NTSC tape is played, 'NTSC→PAL' appears on screen for about 5 seconds

Some TVs will shrink the picture and place black bars at the top and bottom of the screen. This is not a malfunction but you may lose some on-screen information

The picture may roll up or down. Correct this by adjusting the vertical hold on the TV set

The counter and tape remaining times will be incorrect

The picture will be distorted during search, still or frame-by-frame playback

Make sure that the window side of the cassette is facing up and the spine label is facing away from the VCR. Insert the cassette as shown in the diagram below; don't use too much force. If the VCR was turned off before you inserted the cassette, the power will come on automatically.

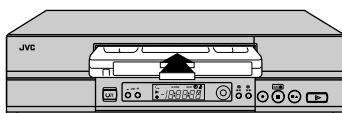

The counter on the TV screen will reset to read '0:00:00'. If the record safety tab on the video cassette has been removed, playback begins automatically.

## 2 Play

If the cassette that you inserted does not start playing automatically, press the ► button on the VCR or the Remote Control. 'bEST' appears blinking in the display panel during automatic tracking (☞ pg. 28).

## 3 Stop & Eject

**STOP** Press the ■/▲ button on the VCR or the ■ button on the Remote Control once to stop playback.

**EJECT** Press the ■/▲ button on the VCR a second time to eject the cassette from the VCR. The cassette will take about 6 seconds to appear once the ■/▲ button has been pressed.

**NOTE:** You can also eject the cassette while the VCR is turned off.

## 4 Rewind and Fast Forward

During Stop Mode:

**REWIND** Press the  button on the VCR or on the Remote Control.

**FAST FORWARD** Press the  button on the VCR on the Remote Control.

## \* Video Heads Cleaning

The heads get dirty in the following cases:

- in an environment prone to extreme temperature or humidity.
- in a dusty environment.
- flaw, dirt or mold on video tapes.
- continuous usage for a long time.



Use a dry cleaning cassette — JVC TCL-2 — in the following cases:

- Rough, poor picture appears while a tape is played back.
- The picture is unclear or no picture appears.
- 'USE CLEANING CASSETTE' appears on the screen (only with 'O.S.D.' set to 'ON' ( pg. 40)).

# Playback Features

## 1 Pause During Playback



Press the **||** button on the VCR or the Remote Control.

- If the paused picture on the TV screen jumps vertically, press the  or  button on the Remote Control until the picture is steady.
- Press **▶** to resume playback.

## 2 Single Frame Movement

You can move backward or forward from the still picture in one of two ways:

**METHOD ONE** Press the **||** button on the Remote Control. Each time the **||** button is pressed, the frame will move forward one frame.

**METHOD TWO** Press **◀**  or **▶**  on the VCR or the Remote Control. Each time one of these buttons is pressed, the frame will advance or move back one frame.

- Press **▶** to resume playback.



### 3 Slow Motion

This VCR will play your cassette forwards or backwards in slow motion. You can make it do this in one of two ways:

**METHOD ONE** During still picture, press and hold **⏏** on the VCR or the Remote Control for 2 seconds, then release. Press and release **⏏** again to return to still picture.

**METHOD TWO** During still picture, press and hold the **⏮** or **⏭** button on the Remote Control. The picture will return to still when you release the button.

- If the slow motion picture on the TV screen jumps vertically, press the **⏮** or **⏭** button until the picture is steady.
- Press **▶** to resume playback.

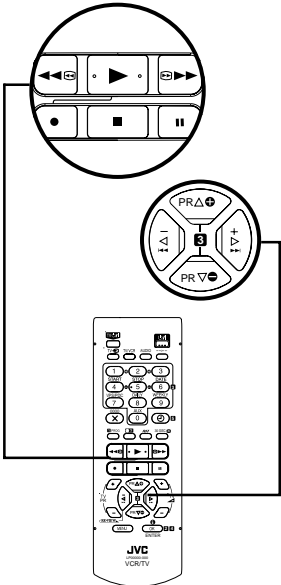

### 4 Variable Speed Search

During playback, press the **⏮** or **⏭** button on the Remote Control. The more times that you press either button, the faster the rate of search. To decrease the speed of search, press the button for the opposite direction.

- Press **▶** to resume playback.

### 5 Picture Search

You can perform picture search in either direction. During playback or still picture, press the **⏭⏭⏭** on the Remote Control for forward picture search, or the **⏮⏮⏮** button for reverse picture search. Each time you press **⏮⏮⏮** or **⏭⏭⏭**, the search speed changes between low-speed and high-speed.

- Press **▶** to resume playback.

#### NOTES:

In the search, still, slow motion or frame-by-frame playback mode

- The picture will be distorted
- The noise bars will appear
- There will be a loss of colour with an LP-recorded tape.

# Recording

TV signals being received by the recorder's built in tuner can be recorded onto a video tape. You can 'capture' a TV programme using your VCR.

## 1 Choose a Programme

### BEFORE YOU START

Turn the TV on

Tune the TV to your Video Channel or to its AV mode

Choose a blank cassette which has the record safety tab still in place

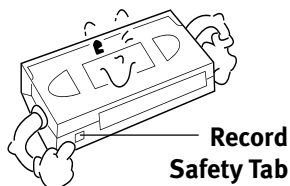

Load the cassette into the VCR (see page 14)

Press or or the number keys on the Remote Control to select the channel that you wish to record.

## 2 Set the Tape Speed

Press . The current setting for the tape speed appears on the on-screen display or the VCR display panel for about 5 seconds. Press again to change the setting while tape speed is displayed. You can choose Standard Play (SP) or Long Play (LP). The picture quality on LP recordings will not be as high as on SP recordings, but the tape will last longer.

## 3 Start Recording

There are two ways to start recording:

**METHOD ONE** Press and hold and then press on the Remote Control.

**METHOD TWO** Press on the VCR.

## 4 Pause and Resume During Recording

On either the VCR or the Remote Control, press to temporarily stop recording and press to resume. You cannot change the preset position on the VCR while it is recording but you can while it is paused (*see Choose a Programme at the top of this page*).

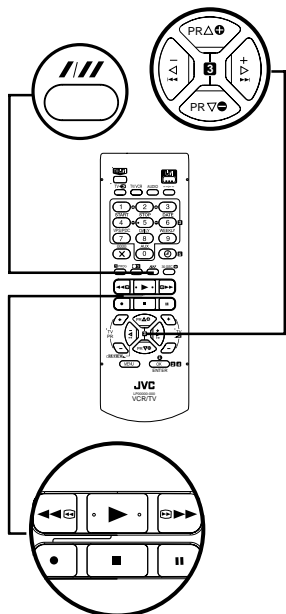

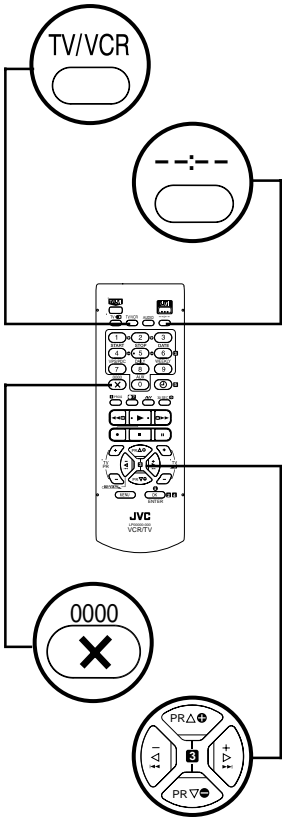

## ! Notes on Recording

When using both the RF and SCART connections, you can switch between TV and VCR by pressing the TV/VCR button on the Remote Control.

If the tape reaches its end during recording, the recording stops and “○” and “▷” on the display panel blink. Press ■/▲ on the VCR to eject the tape or press ◀◀ to rewind the tape.

## \* Display Tape Remaining Time

Press the ---:-- button so that the tape remaining time is shown on the TV screen with ‘REMAIN’ indication. The on-screen information will disappear after about 5 seconds.

**NON-STANDARD TAPES** Sometimes, a tape will not conform to the standards accepted by this VCR. In such cases the tape remaining time may not appear immediately, be incorrect or simply show as ‘--:--’.

## \* Change Display Information

By pressing the ---:-- button repeatedly, you can change the display on the VCR between the clock time and the preset position. The preset position cannot be shown during playback.

## \* Resetting the Counter

Press the ---:-- button so that the counter display appears on the TV screen. While the display is shown, press the 0000 button. You can reset the counter to ‘0:00:00’ before starting playback or recording.

## \* Record a Programme While Watching Another

Once you have started recording all you need to do is use the controls on your TV set to tune to a different programme. The programme set using the PR +/– on the Remote Control is the one which will be recorded.



## Recording Resume Function

If there is a power cut during recording (or Instant Timer Recording or timer recording), the recording will resume automatically when power is restored to the VCR unless the VCR's memory backup has expired.



## Instant Timer Recording

This method allows you to quickly set the VCR to record in 30 minute increments.

**START RECORDING** Press ● on the VCR once. If left in this state, the VCR will keep recording until the tape runs out.

**ENGAGE INSTANT TIMER RECORDING** Press ● again and the display panel will show a flashing Record indicator (○) and '0:30'. This means that the VCR will record for 30 minutes on the programme already selected and then stop automatically.

**INCREASE TIME** Each time ● is pressed, the time limit is increased by 30 minutes to a maximum of 6 hours.

This function only works with the ● button on the VCR, not the Remote Control.

If the tape reaches its end during recording, the recording stops and "○" and "▷" on the display panel blink. Press ■/▲ on the VCR to eject the tape or press ◀◀ to rewind the tape.

# VIDEO Plus +<sup>®</sup>

## Timer Programming

### BEFORE YOU START

Make sure that the VCR's clock is set correctly

Insert a cassette with the safety tab in place

Turn on the TV and select the Video channel or the AV Mode

The VIDEO Plus+ system uses the code numbers – called PlusCode numbers – printed after each programme in your TV listings guide. These are a kind of shorthand for video recorders and using them automatically sets your VCR to record the correct programme, channel and time.

### 1 Get to the VIDEO Plus + Screen

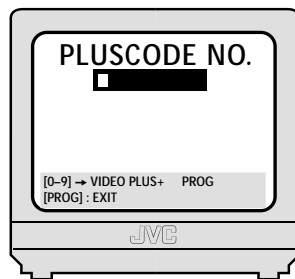

Press **PROG**. Press **▲▼** to place the pointer next to “VIDEO PLUS+”, then press **OK** or **▶**. The **PLUSCODE NO.** screen appears.

### 2 Enter the PlusCode Number

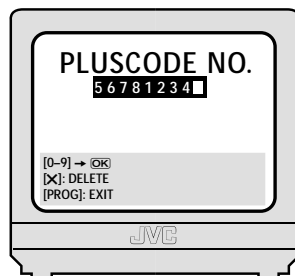
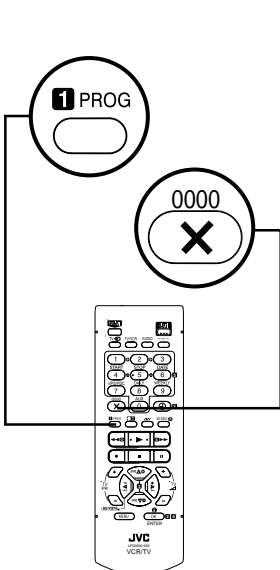

Press the number keys on the Remote Control to enter the PlusCode number of the programme you wish to record. If you make a mistake, press **X** to delete the incorrect number and then enter the correct one.

## 3

## Check the Results

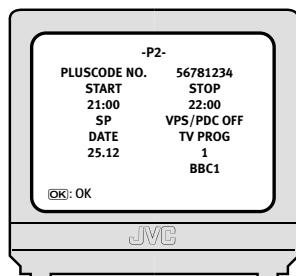
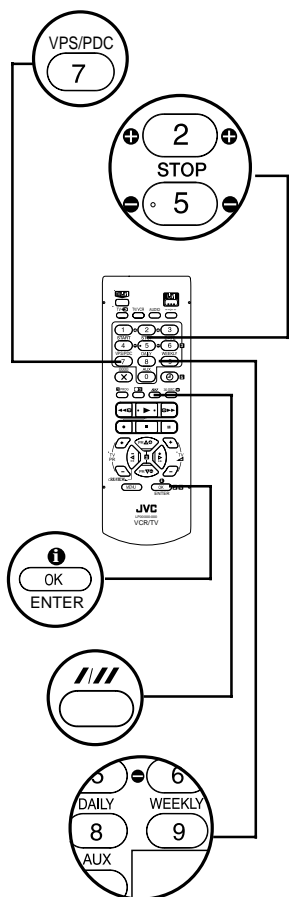

Press **OK**. The VIDEO Plus+ Program screen appears.

Make sure that the preset number displayed is the one that you want. If it is incorrect, the wrong programme will be recorded.

**ERRORS** If the PlusCode number you entered is invalid, **ERROR** appears on the TV screen.

**SET CHANNEL POSITION NUMBER** Make sure the channel position you wish to record is displayed. If “TV PROG” displays “--”, set the Channel Position number correctly. Press **PRAB** or **PRVB** button to input the channel position number on which your recorder receives the station. Then press **OK** (or **▶**, **▶**).

**SET TAPE SPEED** You can change the tape speed between Standard Play (SP) and Long Play (LP) by pressing **///**.

**SET PDC MODE** Press **PDC** (number key 7) to change between **ON** and **OFF**. Programme Delivery Control (**PDC**) is a service designed to ensure that timer recording still works in the event of a change in time of broadcast. If you set **PDC** to **ON**, your VCR will be turned on not by its own timer but by a signal transmitted by the broadcaster. This means that if an advertised programme is delayed, your VCR will still record it properly.

**CHANGE STOP TIME** Press **STOP** **+**/**-** (number key 2 and 5). You can compensate for anticipated changes in schedule using this method.

**SERIAL RECORDING** To set the VCR to record the same programme on a daily (Monday-Friday) or weekly basis, press **DAILY** (number key 8) or **WEEKLY** (number key 9) to turn the function on. Pressing the same key again turns the function off. You will see your selection appear on the TV screen.

**CAPACITY** You can set this VCR to timer record up to eight programmes. If you try to enter a ninth, **PROGRAM FULL** appears on the screen.

**SATELLITE RECEIVER USERS** To timer-record a satellite broadcast using the VIDEO Plus+ system:



- You cannot set **PDC** to **ON**.
- You cannot timer-record the satellite broadcast received on the channel position ‘o’ by the satellite receiver.
- Leave the satellite receiver’s power on.



## 4

## Return to Normal Screen







Press **PROG** or **OK**. **PROGRAM COMPLETED** appears on the TV screen for about 5 seconds, then the normal TV screen appears.

## 5 Engage Timer Mode

You must now put the VCR into Timer Mode by pressing  otherwise no recording will take place.  will appear on the display panel. Make sure that the VCR turns off automatically. To disengage the Timer Mode, press  again.

If a video tape with the safety tab removed is loaded, , Play indicator () and Record indicator () will flash. Insert another tape with the safety tab in place to record!

If no video tape is loaded,  indicator will flash. Insert a tape to record!

If the tape reaches its end during timer recording, the recording stops and “”, “” and “” on the display panel blink. Press  to disengage timer, then press  on the VCR to eject the tape or press  then press  to rewind the tape.

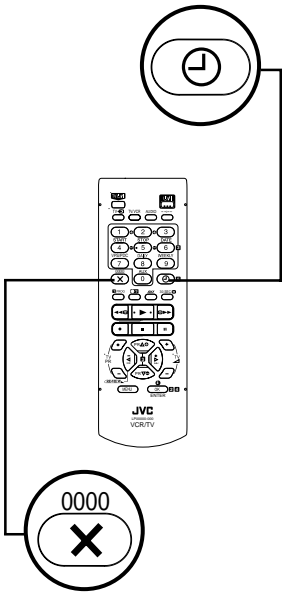

# Express Timer Programming

If you do not know the PlusCode number for the programme that you wish to record, follow the instructions below to manually set your VCR to record.

## BEFORE YOU START

Make sure that the VCR's clock is set correctly

Insert a cassette with the safety tab in place

Turn on the TV and select the Video channel or the AV Mode

## 1 Get to the Timer Programming Set Screen

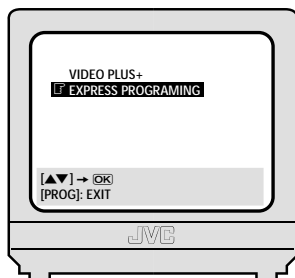

Press **PROG**. You will see the following TV screen information.

## 2 Get to the Programme Screen

Press **▲▼** to place the pointer (highlighted bar) next to "EXPRESS PROGRAMMING", then press **OK** or **▶**.

## 3 Enter Programme Details

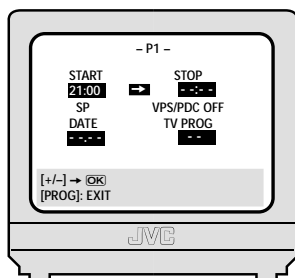

**SET START TIME** Use the **START +/−** buttons (number keys 1 and/or 4) to enter the start time.

**SET STOP TIME** Use the **STOP +/−** buttons (number keys 2 and/or 5) to enter the stop time.

**SET DATE** Use the **DATE +/−** buttons (number keys 3 and/or 6) to adjust the date (current date will automatically appear).

**SET PROGRAMME** Use the **PR +/−** buttons to enter the programme required.

**SET TAPE SPEED** You can change the tape speed between Standard Play (SP) and Long Play (LP) by pressing **///**.

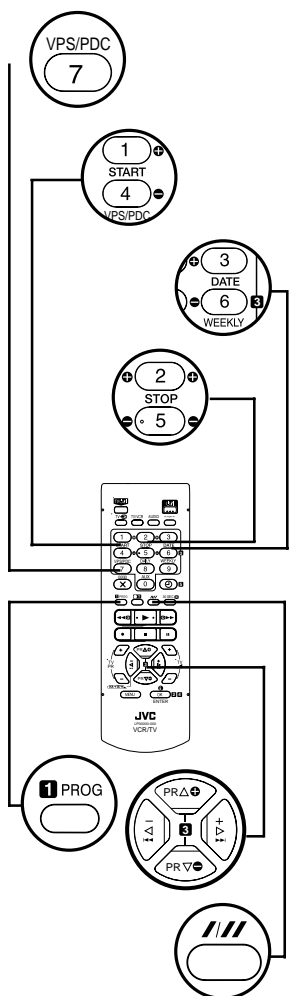



**SET PDC MODE** Press **PDC** (number key 7) to change between **ON** and **OFF**. Programme Delivery Control (**PDC**) is a service designed to ensure that timer recording still works in the event of a change in time of broadcast. If you set **PDC** to **ON**, your VCR will be turned on not by its own timer but by a signal transmitted by the broadcaster. This means that if an advertised programme is delayed, your VCR will still record it properly.

**SATELLITE RECEIVER USERS** To timer-record a satellite broadcast using Express Timer Programming:

- You cannot set **PDC** to **ON**.
- You cannot timer-record the satellite broadcast received on the channel position '0' by the satellite receiver.
- Leave the satellite receiver's power on.

For memory capacity and Serial Recording, see **VIDEO Plus+ Timer Programming** on page 22.

4

## Return to Normal Screen

Press **PROG** or **OK**. **PROGRAM COMPLETED** appears on the TV screen for about 5 seconds, then the normal TV screen appears.

5

## Engage Timer Mode

You must now put the VCR into Timer Mode by pressing **⏸** otherwise no recording will take place. **⏸** will appear on the display panel. To disengage the Timer Mode, press **⏸** again.

If a video tape with the safety tab removed is loaded, **⏸**, Play indicator (**▶**) and Record indicator (**Ⓞ**) will flash. Insert another tape with the safety tab in place to record!

If no video tape is loaded, **⏸** indicator will flash. Insert a tape to record!

If the tape reaches its end during timer recording, the recording stops and "Ⓞ", "Ⓞ" and "▶" on the display panel blink. Press **⏸** to disengage timer, then press **▶/▲** on the VCR to eject the tape or press **⏸/|** then press **◀◀◀** to rewind the tape.

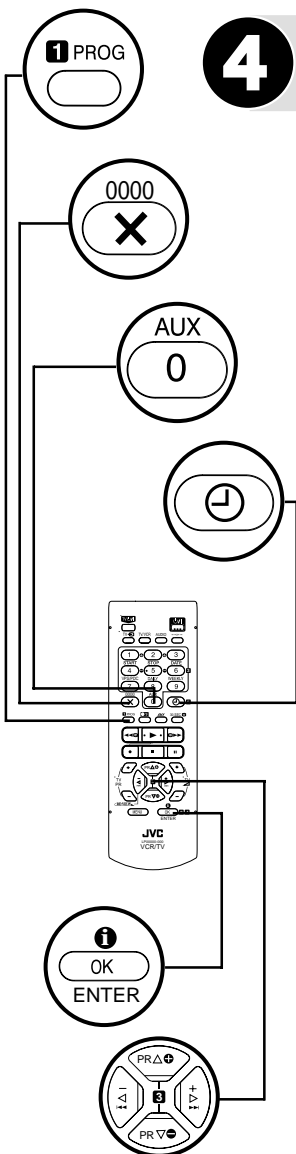



## Check, Cancel & Change Programmes

Press  $\ominus$ , then press  $\odot/|$  to disengage the timer mode.

**REVIEW THE PROGRAMMES** Press  $\blacksquare$ . The TV screen will display a list of the programmes set for timer recording (screen A).

Pressing  $\blacksquare$  again will cycle through each of the entries in the VCR's memory (screen B).

**CANCEL A PROGRAMME** Press  $\times$  to cancel a programme.

**CHANGE A PROGRAMME** Use **START**  $\oplus/\ominus$  (number keys 1 and 4), **STOP**  $\oplus/\ominus$  (number keys 2 and 5), **DATE**  $\oplus/\ominus$  (number keys 3 and 6), **PR**  $\oplus/\ominus$ , **////**, **DAILY** (number key 8), **WEEKLY** (number key 9) and **PDC** (number key 7) buttons as necessary.

**RETURN TO NORMAL SCREEN** Press  $\blacksquare$  as many times as necessary.

**RETURN TO TIMER MODE** If there are still programmes to be recorded, press  $\ominus$ .

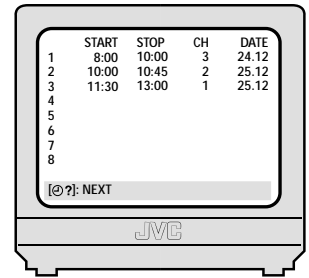

Screen A

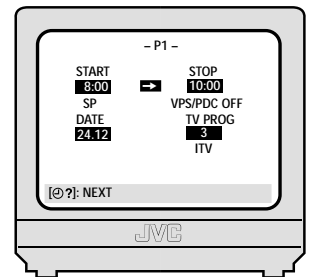

Screen B

# Advanced Features

<b>Picture Quality .....</b>	<b>28</b>
<b>Recording According To Tape Type.....</b>	<b>30</b>
<b>The B.E.S.T. Picture System .....</b>	<b>32</b>
<b>Sound Modes .....</b>	<b>33</b>
<b>Finding Specific Scenes .....</b>	<b>34</b>
<b>Auto Satellite Program Recording .....</b>	<b>35</b>
<b>Editing .....</b>	<b>37</b>
<b>Other Functions .....</b>	<b>41</b>
<b>Connection to a Stereo System .....</b>	<b>44</b>
<b>Video Channel Set .....</b>	<b>45</b>
<b>Tuner Set .....</b>	<b>46</b>
<b>Clock Set .....</b>	<b>52</b>

# Picture Quality



## Manual Tracking

Your VCR is equipped with automatic tracking control. This will be adequate for most tapes and will automatically adjust the tracking to suit the particular tape in use but if you insert an old or worn tape, it may be necessary to manually adjust the tracking in order to get the best picture. If automatic tracking fails, you will notice noise bars appearing across the picture; you can correct this by manually overriding the tracking using the following steps.

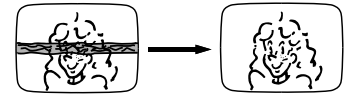

**OVERRIDE AUTOMATIC TRACKING** During playback, press **///** on the Remote Control to engage manual tracking.

**ADJUST TRACKING MANUALLY** Use the **PR+** or **PR-** buttons to adjust the tracking manually.

### NOTES:

- Press **///** again to re-engage automatic tracking.
- When a new tape is inserted, the VCR returns to automatic tracking.



## Video Stabilizer

You can automatically correct vertical vibrations in the picture when playing back unstable recordings made on another VCR. The default setting is **OFF**.

**GET TO THE MODE SET SCREEN** Press **MENU**. Move the highlight bar to **MODE SET** using the **PRAD** and **PRVD** buttons and press **OK** (or **▶▶**, **▶▶**).

**SELECT VIDEO STABILIZER MODE** Move the highlight bar to **VIDEO STABILIZER** using the **PRAD** and **PRVD** buttons. Press **OK** (or **▶▶**, **▶▶**) to set to **ON**.

**RETURN TO NORMAL SCREEN** Press **MENU**.

### NOTES:

- When you finish viewing a tape, be sure to set this function to **OFF**.
- Regardless of the setting, this function has no effect during recording and during special effects playback.
- The on-screen display may jitter vertically when this function is set to **ON**.
- To watch recordings with close-caption, set this function to **OFF**.

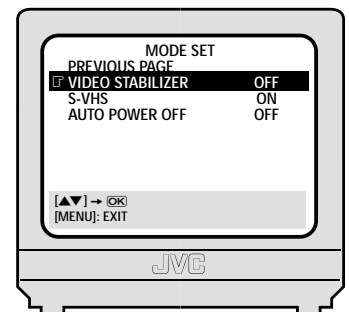



# Picture Control

This feature allows you to select the most appropriate picture quality according to the type of tape or use of this VCR. The default setting is **AUTO**.

**GET TO THE MODE SET SCREEN** Press . Move the highlight bar to **MODE SET** using the and buttons and press (or ).

**SELECT PICTURE CONTROL MODE** Move the highlight bar to **PICTURE CONTROL** using the and buttons. Press (or ) to select the desired mode:

- **AUTO (NORM)** Provides optimised picture benefits of B.E.S.T. Picture System. When **B.E.S.T.** is **OFF**, **PICTURE CONTROL** switches automatically from **AUTO** to **NORM**.
- **EDIT** Minimizes picture degradation during editing (recording or playback).
- **SOFT** Reduces image coarseness when viewing overplayed tapes containing lots of noise.

**RETURN TO NORMAL SCREEN** Press .

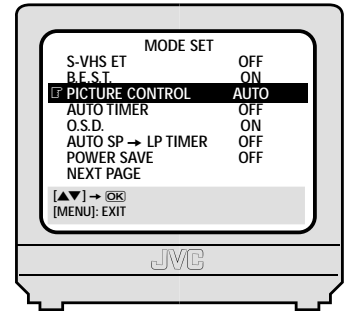

# Recording According To Tape Type



## Super VHS ET (S-VHS ET)

This function allows you to record in SP mode on VHS tapes with S-VHS picture quality. Tapes recorded using this function can be played back on a VCR equipped with the S-VHS ET function.

- You can activate this function only before you start recording on a VHS tape.
- Before recording, make sure that **B.E.S.T.** is set to **ON**. (☞ pg. 32)

**ENGAGE S-VHS ET MODE** Press the **S-VHS ET** button on the VCR. The S-VHS ET indicator on the VCR's front panel lights up.

- The S-VHS indicator lights up on the display panel.
- To disengage the S-VHS ET mode, press **S-VHS ET**. The S-VHS ET indicator goes off.

**START RECORDING** Press and hold ● and press ► on the Remote Control (or press ● on the VCR).

### NOTES:

- Use of high grade tapes is essential for S-VHS ET recordings. On some tapes, picture quality will not improve even if the S-VHS ET function is used. Check the recording quality before you start important recordings.
- You cannot activate the S-VHS ET function ...
  - ... while recording is in progress.
  - ... while timer-recording or Instant Timer Recording (☞ pg. 20) is in progress.
  - ... while B.E.S.T. (☞ pg. 32) is in progress.
- S-VHS ET does not work ...
  - ... with S-VHS tapes.
  - ... with recordings in LP mode.
- To keep the highest quality recording and playback pictures over a long period of time, S-VHS recording on S-VHS tapes is recommended.
- You can play back S-VHS ET recordings on most S-VHS recorders and on VHS recorders equipped with SQPB (S-VHS QUASI PLAYBACK) function. (Notice: some recorders are not compatible with this function.)
- On some tapes noise may appear when playing back a tape recorded with this function. (If playback picture becomes blurred or interrupted, use a cleaning cassette.)
- In the high-speed search, still, slow-motion or frame-by-frame playback modes (☞ pg. 16 – 17), noise may appear. If these modes are used frequently on a tape recorded with the S-VHS ET function, the tape may be damaged and the picture may be deteriorated.



## Super VHS (S-VHS), S-VHS ET and VHS

Your VCR can record in S-VHS, S-VHS ET or VHS.

### **To record in S-VHS:**

Perform the steps below to set **S-VHS** to **ON**. Then, insert a cassette marked 'S-VHS', the S-VHS indicator will light on the display panel. The S-VHS recording mode will be selected.

### **To record in S-VHS ET on a VHS cassette:**





See 'Super VHS ET (S-VHS ET)' on page 30.





### **To record in VHS:**

Insert a cassette marked 'VHS'. If the S-VHS ET indicator on the VCR is lit and the S-VHS ET mode is activated, press **S-VHS ET**. The indicator goes off. The VHS recording mode will be automatically selected regardless of the S-VHS mode setting.

### **To record in VHS on an S-VHS cassette:**

Insert the cassette marked 'S-VHS', the S-VHS indicator will light on the display panel. Then, perform the steps below to set the **S-VHS** to **OFF**; the S-VHS indicator will go out. The VHS recording mode will be selected.

**GET TO THE MODE SET SCREEN** Press . Move the highlight bar to **MODE SET** using the  and  buttons and press  (or  ).

**SELECT S-VHS MODE** Move the highlight bar to **S-VHS** using the  and  buttons. Press  (or  ) to set to **ON** or **OFF**.

**RETURN TO NORMAL SCREEN** Press .

### **NOTE:**

When playing back a tape that has been recorded in S-VHS or S-VHS ET, the S-VHS indicator lights on the display panel regardless of the 'S-VHS' mode setting.

# The B.E.S.T. Picture System

## ABOUT B.E.S.T.

Works in SP and LP modes

Works before Timer Recording

B.E.S.T. data is lost when tape is ejected

Pressing the ● button on VCR does not start Instant Timer Recording while B.E.S.T. is turned ON

The Biconditional Equalised Signal Tracking (B.E.S.T.) System checks the condition of the tape in use and compensates during recording and playback to give the best picture quality possible. The default setting is ON.



## Turning B.E.S.T. ON or OFF

**GET TO THE MODE SET SCREEN** Press **[MENU]**. Move the highlight bar to **MODE SET** using the **[PRAD]** and **[PRVD]** buttons and press **[OK]** (or **[↑]**, **[↓]**).

**SELECT B.E.S.T. MODE** Move the highlight bar to **B.E.S.T.** using the **[PRAD]** and **[PRVD]** buttons and press **[OK]** (or **[↑]**, **[↓]**) to set **B.E.S.T. ON** or **OFF**.

**RETURN TO NORMAL SCREEN** Press **[MENU]**.

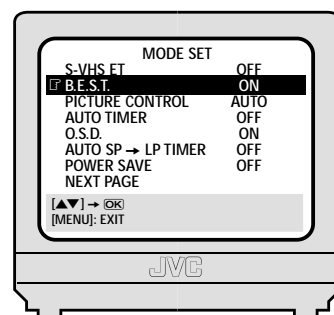

## Recording and Playback Using B.E.S.T.

**RECORDING** Press and hold ● and press ► on the Remote Control (or press ● on the VCR). The VCR spends about 7 seconds assessing the condition of the tape and then begins recording.



During B.E.S.T.

→ pause of 7 seconds →

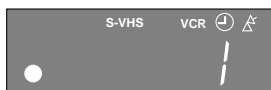

B.E.S.T. complete

**PLAYBACK** Press ►. The VCR adjusts the playback picture quality based on the condition of the tape in use. B.E.S.T. is active during Auto Tracking. **bEst** appears on the VCR's display panel.



## Avoiding B.E.S.T. Time Delay

Since B.E.S.T. introduces a 7 second delay before recording starts, you may wish to compensate by first pressing **[RECORD PAUSE]** and **[RECORD]** together (this puts the VCR into **RECORD PAUSE** mode during which time the VCR performs the B.E.S.T. tape assessment) and then pressing ► when you wish to start recording.



# Sound Modes



## NICAM Stereo and Bilingual Broadcasts

**BEFORE YOU START**

Set On Screen Display (O.S.D.) to ON (pg. 40)

This VCR is equipped with a digital stereo sound decoder (NICAM) which makes the reception of stereo and bilingual broadcasts possible. When the VCR is tuned to a different preset, the type of broadcast will be displayed on the TV screen for a few seconds.

**SELECT STEREO** Press **AUDIO** until **HIFI L R** appears on the TV screen.

**SELECT BILINGUAL** Press **AUDIO** until **HIFI L** or **HIFI R** appears on the TV screen (as required).

**SELECT STANDARD** To listen to standard monaural audio during a NICAM broadcast, press **AUDIO** until **NORM** appears on the TV screen.



## Soundtrack Selection

This VCR is capable of recording three soundtracks and will play back the one that you select with the **AUDIO** button.

TRACK	USE
<b>HI FI</b> L R	Hi-Fi stereo pre-recorded tapes
<b>HI FI</b> L	Main audio of bilingual tapes
<b>HI FI</b> R	Sub-audio of bilingual tapes
<b>NORM</b>	Audio-dubbed tapes
<b>HI FI</b> <b>NORM</b>	Audio-dubbed tapes



## Notes



**NORMAL SELECTION** **HI FI L R** should normally be selected. In this mode, Hi-Fi stereo tapes are played back in stereo and the normal audio track is played back automatically for tapes which only have normal audio.

**RECORDING** If the NICAM stereo signal is poor or unavailable, the VCR will automatically record standard monaural audio onto both the Hi-Fi and normal audio tracks. This will eliminate possible audio interference.

# Finding Specific Scenes



## Skip Search

During playback, press **30 SEC**  up to 4 times. Each press of the **30 SEC**  button will cause the VCR to go into fast-motion playback for a period of 30 seconds. Normal playback resumes automatically.

- To return to normal playback during a Skip Search, press .









## Index Search

Each time you record a programme, this VCR puts an index marker at the point that you started recording. The VCR can fast wind to any one of nine index markers in either direction from the point that you stop the tape.

### NOTE:

Before starting, make sure the VCR is in the Stop mode.

**FINDING FIRST INDEX MARKER** Press  $\triangleleft$   or  $\triangleleft$   or  $\triangleright$   once. The TV screen will display  $\lll 1$  or  $\ggg 1$  and the VCR begins searching through the tape in the corresponding direction for the first index marker from its current position.

**FINDING SUBSEQUENT INDEX MARKERS** Press  $\triangleleft$   or  $\triangleleft$   or  $\triangleright$   the required number of times (e.g. five). The TV screen will display  $\lll 5$  or  $\ggg 5$  and the VCR begins searching through the tape in the corresponding direction for the fifth index marker from its current position.



## Instant Review

The display panel tells you how many timer-recorded programmes are on the tape. If you have three, the **REVIEW** indicator and '3' blink on the display panel. To watch the first of these three programmes, press **REVIEW** *three times*. You can move back up to nine programmes from your current position. Pressing the **REVIEW** button causes the VCR to turn on, rewind to the beginning of the the last timer-recorded programme and begin playback.



If you press the **REVIEW** button one time, the front display panel will display “-1” and start rewinding. The number will be changed whenever you press **REVIEW** up to “-9”.

**TIMER MODE** Instant Review will not work while the VCR is in Timer mode.

# Auto Satellite Programme Recording



## Auto Record from Satellite Receiver

This facility allows a programme timer-recorded using the satellite receiver to be recorded on the VCR.

**CONNECT UP** Connect your satellite receiver, TV and VCR (see diagram below).

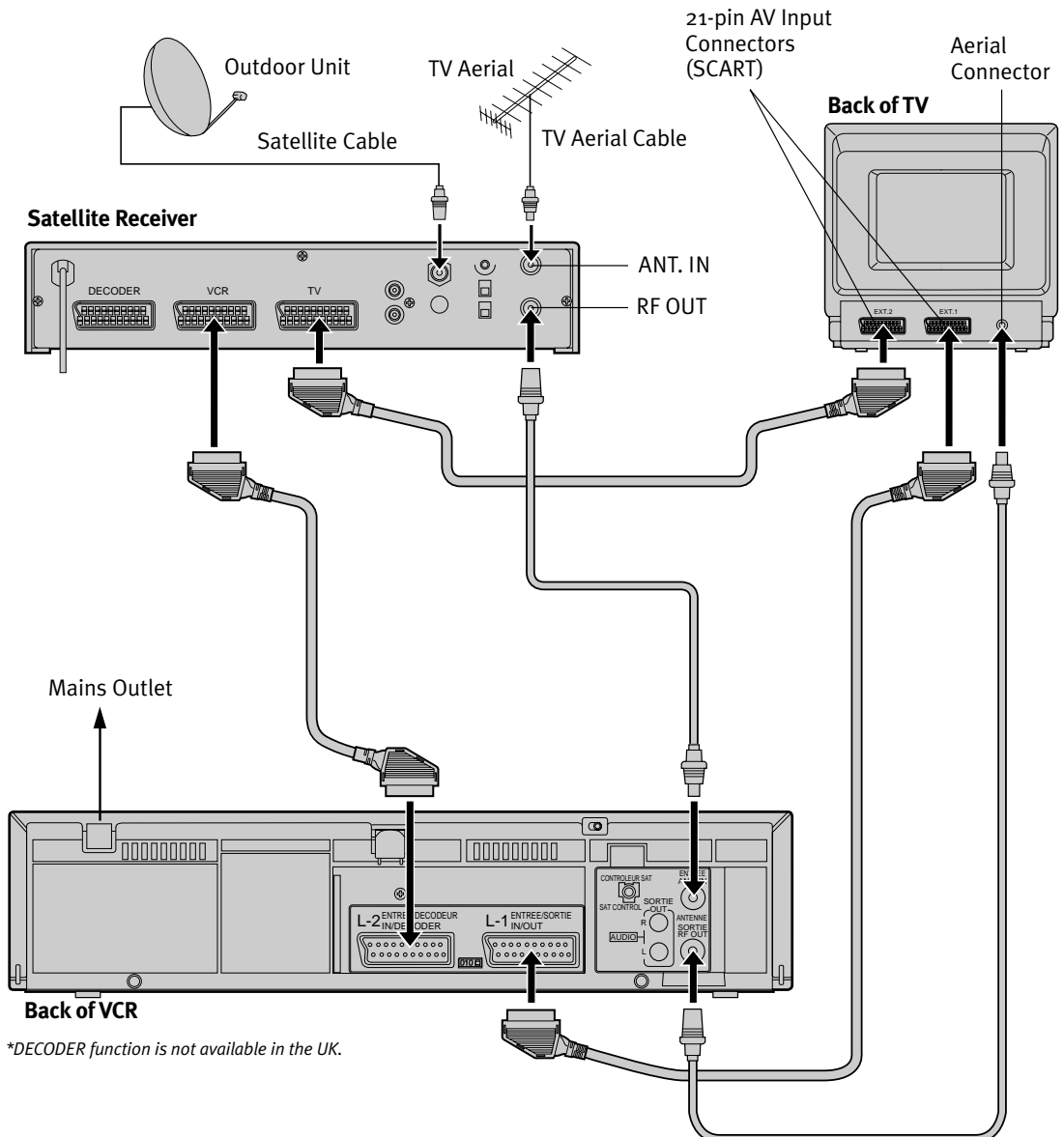

\*DECODER function is not available in the UK.

**PROGRAMME SATELLITE RECEIVER** Enter the details of the programme into your satellite receiver (*see receiver manual*) and put a tape in the VCR.

**SET TAPE SPEED** Press **///** on the Remote Control to set the tape speed to either **SP** or **LP**.

**ENGAGE VCR IN AUTO MODE** Press and hold **SAT** (II) on the VCR for about 2 seconds. The **SAT** indicator on the VCR display panel lights up and the VCR turns off automatically. Any signal detected at the **L-2 IN/DECODER** connector will automatically start the VCR recording; when the signal stops, so will the VCR.



## Notes

**CONNECTORS** Auto Satellite Prog Recording is only possible using the **L-2 IN/DECODER** connector.

**TIMER MODE** You cannot put the VCR into **TIMER MODE** when using Auto Satellite Prog Recording Mode.

**REVIEW** The number of programmes recorded will not be displayed on the VCR display panel when the **REVIEW** button is pressed.

**TIMER RECORDING** Auto Satellite Prog Recording is not possible if your satellite receiver does not have a timer.

**INDICATOR** The **SAT** indicator light flashes when Auto Satellite Prog Recording is in progress.

**DISENGAGE** To disengage the VCR during Auto Satellite Prog Recording, press the **⏏/|** button. The VCR will stop recording and turns off.

**TAPE SPEED** When recording two or more programmes consecutively, you cannot set a different tape speed for each programme. The first speed selected will apply to all programmes in that recording session.

**B.E.S.T.** The **B.E.S.T.** system will not work during Auto Satellite Prog Recording.

**JUST CLOCK** Just Clock does not work when in Auto Satellite Prog Recording mode.

**INCOMING SIGNAL** The VCR will only react to the start of an incoming signal at the **L-2 IN/DECODER** connector. If you try to engage Auto Satellite Prog Recording Mode whilst the satellite receiver is powered on, the **SAT** indicator light will flash but the VCR will not record. You must power the satellite receiver off then on again to begin recording in these circumstances.

**CABLE INPUT** You can record in the same way from a cable system as long as you connect the cable system has a timer on/off function and is connected to the **L-2 IN/DECODER** connector.

**INCOMPATIBILITIES** Some satellite receivers output signals even when turned off. These receivers cannot be used with this VCR in this way.

# Editing



## L-1 OUTPUT Setting

The **L-1 IN/OUT** connector delivers either a composite signal (regular video signal) or a Y/C signal (a signal in which the luminance and chrominance signals are separated). Set **L-1 OUTPUT** to the appropriate mode depending on the type of unit connected to the rear panel **L-1 IN/OUT** connector of this VCR.

**GET TO THE OUTPUT/INPUT SET SCREEN** Press **MENU**. Move the highlight bar to **OUTPUT/INPUT SET** using the **PRAD** and **PRVB** buttons and press **OK** (or **↵**).

**SELECT MODE** Move the highlight bar to **L-1 OUTPUT** using the **PRAD** and **PRVB** buttons. Press **OK** (or **↵**) to select the desired mode:

### FOR L-1 OUTPUT

- **VIDEO** : If a connected device's input is compatible only with regular video signals, set to **VIDEO**.
- **S-VIDEO** : If a connected device's input is compatible with Y/C signals, set to **S-VIDEO**. This setting will let you take advantage of higher-quality S-VHS pictures. (For connection, be sure to use a 21-pin SCART cable that is compatible with the Y/C signal.)

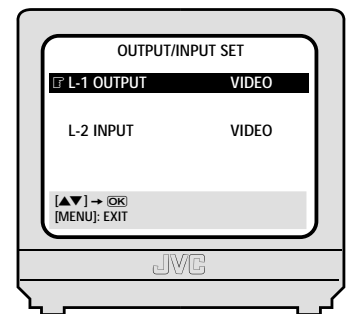

**RETURN TO NORMAL SCREEN** Press **MENU**.



## L-2 INPUT Setting

The **L-2 IN/DECODER** connector accepts either a composite signal (regular video signal) or a Y/C signal (a signal in which the luminance and chrominance signals are separated). Set **L-2 INPUT** to the appropriate mode depending on the output signals of the connected unit.

**GET TO THE OUTPUT/INPUT SET SCREEN** Press **MENU**. Move the highlight bar to **OUTPUT/INPUT SET** using the **PREV** and **NEXT** buttons and press **OK** (or **+** **▷**).

**SELECT MODE** Move the highlight bar to **L-2 INPUT** using the **PREV** and **NEXT** buttons. Press **OK** (or **+** **▷**) to select the desired mode:

### FOR L-2 INPUT

- **VIDEO** : If a connected device's output is compatible only with regular video signals, set to **VIDEO**.
- **S-VIDEO** : If a connected device's output is compatible with Y/C signals, set to **S-VIDEO**. This setting will let you take advantage of higher-quality S-VHS pictures. (For connection, be sure to use a 21-pin SCART cable that is compatible with the Y/C signal.)

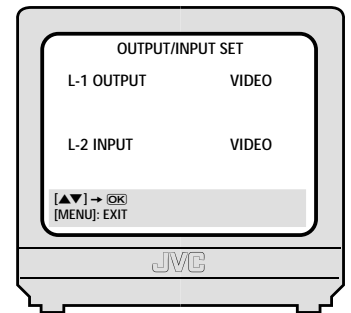

**RETURN TO NORMAL SCREEN** Press **MENU**.



## Editing Using Another VCR

**CONNECT UP** Connect the player's 21-pin SCART connector to the recorder's 21-pin SCART connector as illustrated.

**A** When using your VCR as the player ...  
... connect its **L-1 IN/OUT** connector to another VCR.

**B** When using your VCR as the recorder ...  
... connect its **L-2 IN/DECODER** or **L-1 IN/OUT** connector to another VCR.

**SET VCR'S INPUT MODE** The recording VCR mode must be set to **AUX**. If this VCR is the recorder, press **AUX** and/or **PR** to select **L-1** (if you've used the **L-2 IN/DECODER** connector) or **L-2** (if you've used the **L-1 IN/OUT** connector). If this VCR is the player, set **O.S.D.** to **OFF**. (☞ pg. 40)

**SET EDIT MODE** See *Picture Control on page 29*.

**START SOURCE VCR** Engage its **PLAY** mode.

**START RECORDING VCR** Engage its **RECORD** mode.

### NOTES:

- All necessary cables can be obtained from your dealer.
- For Y/C signal input/output, be sure to use a 21-pin SCART cable that is compatible with the Y/C signal.
- When you set **PICTURE CONTROL** to **EDIT** to dub tapes (☞ pg. 29), be sure to select **AUTO** (or **NORM** when **B.E.S.T.** is set to **OFF**) after you finish dubbing the tapes.

**A** Your VCR as the Player

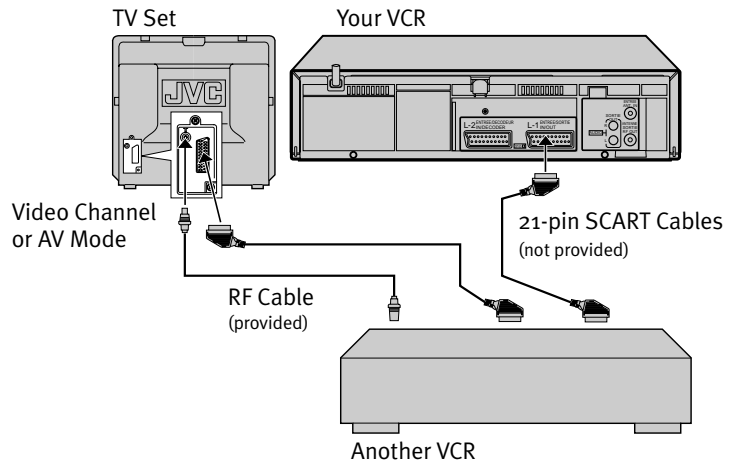

**B** Your VCR as the Recorder

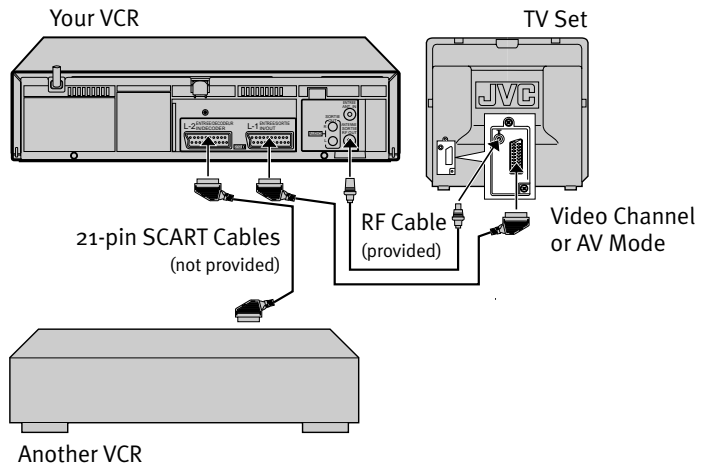



# Other Functions



## On-Screen Display (O.S.D.)

This function allows you to turn the on-screen information ON or OFF.

**GET TO THE MODE SET SCREEN** Press **MENU**, move the highlight bar to **MODE SET** using the **PRAD** and **PRVB** buttons and press **OK** (or **▶**).

**ENABLE/DISABLE OSD** The default setting for OSD is ON. Move the highlight bar to **OSD** using the **PRAD** and **PRVB** buttons and press **OK** (or **▶**) to toggle between ON and OFF.

**RETURN TO NORMAL SCREEN** Press **MENU**.

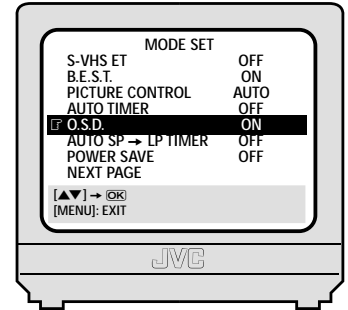

### GUIDE TO ON-SCREEN DISPLAY INFORMATION

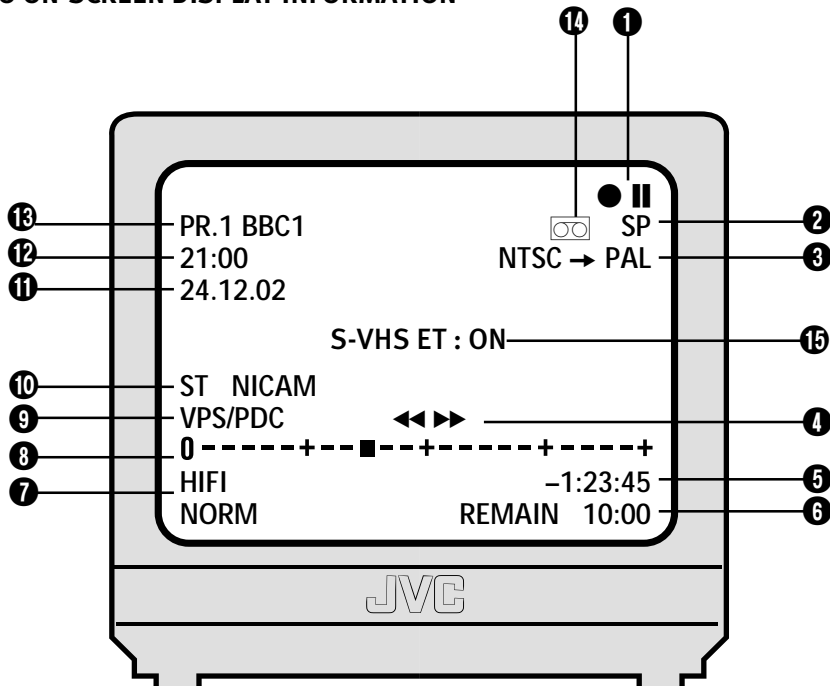

- |  |                                  |   |
|--|----------------------------------|---|
| <b>1</b> Operation mode indicators                 | <b>6</b> Tape remaining time     | <b>13</b> Preset position number and station name/Auxiliary input mode indicator (L-1 or L-2) |
| <b>2</b> Tape speed SP/LP/EP (EP is for NTSC only) | <b>7</b> Audio mode              | <b>14</b> 'Cassette Loaded' indicator   |
| <b>3</b> NTSC playback display                     | <b>8</b> Tape position indicator | <b>15</b> S-VHS ET Indicator (S-VHS ET: ON/S-VHS ET: OFF)                                     |
| <b>4</b> Tape direction                            | <b>9</b> VPS/PDC indicator       |   |
| <b>5</b> Counter display                           | <b>10</b> NICAM display          |   |
|  | <b>11</b> Day/month/year         |   |
|  | <b>12</b> Current time           |   |



## Power Save Mode

You can reduce the power consumption while the VCR is turned off.

**GET TO THE MODE SET SCREEN** Press **MENU**. Move the highlight bar to **MODE SET** using the **PRAD** and **PRVD** buttons and press **OK** (or **+**, **▷**).

**SELECT POWER SAVE MODE** Move the highlight bar to **POWER SAVE** using the **PRAD** and **PRVD** buttons. Press **OK** (or **+**, **▷**) to select **ON** or **OFF**.

**RETURN TO NORMAL SCREEN** Press **MENU**.

### NOTES:

- During Power Save, the display panel will be turned off.
- The Just Clock function (see pg. 51) does not work while the Power Save mode is engaged.
- While the VCR is in the Power Save mode, the picture may be distorted momentarily when you turn on/off the VCR.
- Power Save does not work when ...
  - ... the VCR is in the Timer mode.
  - ... the VCR's power is turned off after timer-recording (or Instant Timer Recording).

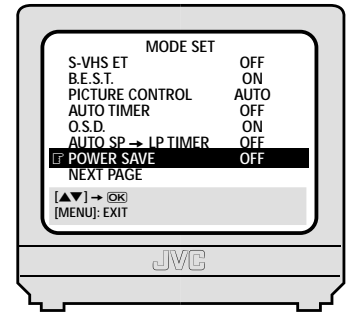

## Auto SP → LP Timer

When timer recording in **SP** mode, if the VCR calculates that there isn't enough tape to record the complete programme, it will automatically switch from **SP** to **LP** mode.

**GET TO THE MODE SET SCREEN** Press **MENU**. Move the highlight bar to **MODE SET** using the **PRAD** and **PRVD** buttons and press **OK** (or **+**, **▷**).

**ENABLE/DISABLE AUTO SP→LP TIMER** Select **AUTO SP→LP TIMER** using the **PRAD** and **PRVD** buttons and press **OK** (or **+**, **▷**) to toggle between **ON** and **OFF**.

**RETURN TO NORMAL SCREEN** Press **MENU**.

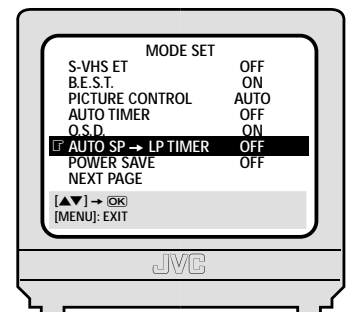



## Auto Timer

When the **AUTO TIMER** is set to **ON**, the timer is automatically engaged when the VCR power is turned off and automatically disengaged when the VCR is powered back on.

**GET TO THE MODE SET SCREEN** Press **MENU**. Move the highlight bar to **MODE SET** using the **PREV** and **NEXT** buttons and press **OK** (or **▶**, **▶**).

**ENABLE/DISABLE AUTO TIMER** Select **AUTO TIMER** using the **PREV** and **NEXT** buttons and press **OK** (or **▶**, **▶**) to toggle between **ON** and **OFF**.

**RETURN TO NORMAL SCREEN** Press **MENU**.

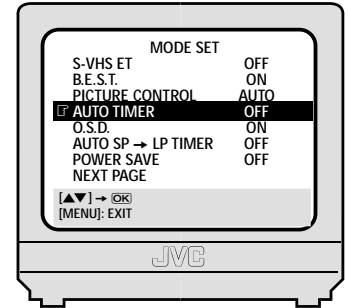

## Auto Power Off/3H

When this function is set to “3H”, the recorder is turned off automatically if no operation is done within 3 hours. “AUTO POWER OFF IN 3 MIN” appears on the screen 3 minutes before the recorder is turned off.

**GET TO THE MODE SET SCREEN** Press **MENU**. Move the highlight bar to **MODE SET** using the **PREV** and **NEXT** buttons and press **OK** (or **▶**, **▶**).

**SELECT AUTO POWER MODE** Move the highlight bar to **AUTO POWER** using the **PREV** and **NEXT** buttons. Press **OK** (or **▶**, **▶**) to select **3H** or **OFF**.

**RETURN TO NORMAL SCREEN** Press **MENU**.

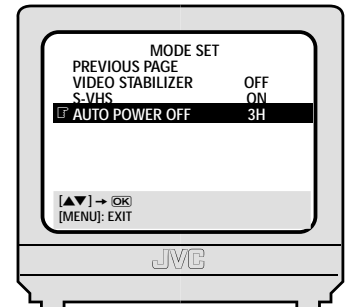

## Repeat Playback

**START REPEAT PLAYBACK** Press **▶**, then press and hold **▶** again for over 5 seconds, then release. The Play indicator (**▶**) will flash on the display panel and the VCR will automatically playback and rewind the tape 100 times and then stop.

**STOP PLAYBACK** Pressing **■**, **▶**, **◀◀◀** or **▶▶▶** stops repeat playback.



## Next Function Memory

**PLAY** To playback immediately after rewinding, press **◀◀◀** and then **▶** within 2 seconds.

**POWER OFF** To power off the VCR immediately after rewinding, press **◀◀◀** and then **⏻** within 2 seconds.

**TIMER STANDBY** To put the VCR in timer standby mode immediately after rewinding, press **◀◀◀** and then **⌚** within 2 seconds.

# Connection to a Stereo System

It is possible to connect your VCR to a suitably equipped stereo system and listen to the soundtrack through the stereo system.

**CONNECT UP** Connect the **AUDIO OUT L** and **R** connectors on the VCR to the **AUX IN** or **TAPE MONITOR** connectors on your stereo. See diagram below.

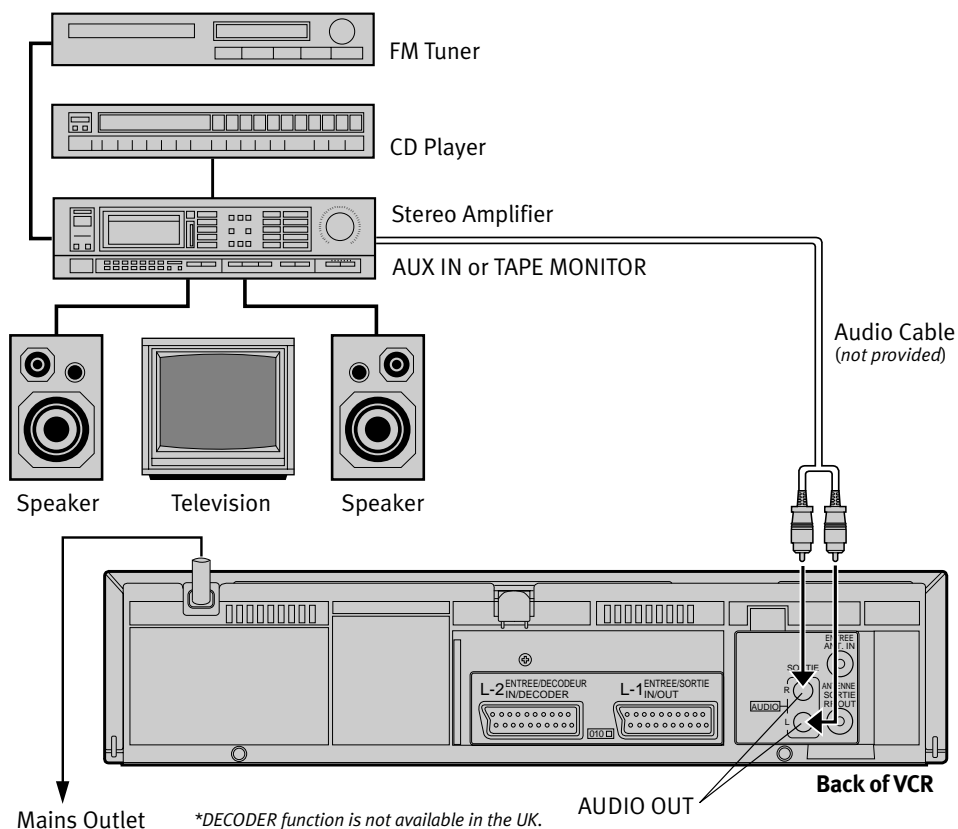

## NOTES ON STEREO CONNECTIONS

**SPEAKER CONNECTIONS** Make sure that you connect the L and R speakers in the right order.

**NICAM TV** If you can receive NICAM TV broadcasts in your area, this VCR can record them independently of the TV set and play them back through the stereo.

**VOLUME** When listening to sound through the connected stereo, turn the TV's volume down to zero.

**DYNAMIC RANGE** This VCR has a Hi-Fi audio dynamic range of 80 dB. Check that your stereo is capable of handling this level of input. If it cannot, you risk speaker damage.

# Video Channel Set

## BEFORE YOU START

The power cord must be plugged in and connected to the VCR

The VCR must be turned off and no cassette inserted

The Remote Control must have batteries inserted

The TV set must be turned on

The VCR can send picture signals to the TV set in one of two ways; RF (ordinary cable included with this VCR) and AV (via a 21-pin SCART cable available from TV and Hi-Fi dealers). Depending upon which method you use, the VCR must have the correct method set up in order to work. The Auto Setup procedure normally takes care of this but if for any reason this fails to happen, the instructions below describe how to set the Video Channel manually.

## 1 Access Video Channel Mode

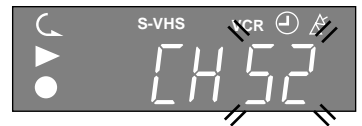

Press and hold the  button for 5 seconds on the VCR until the display panel shows the following information:



## 2 Set Video Channel

**FOR AV CONNECTION** Press  until the display panel shows 'CH--'. The Video Channel is now set to OFF. Go to Step 3.



**FOR RF CONNECTION** Press  or  to set the VCR to a vacant channel number between 52 and 69 which is not occupied by any station in your area (refer to station list on page 49). In the example, we have presumed that channel 52 is vacant and have set the VCR to 52:

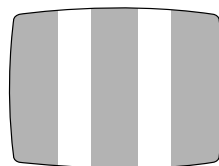



Now tune the TV set to channel 52 (refer to TV manual if necessary); you should see two vertical white bars appear on the TV screen. If the bars do not appear or are not clear, choose another vacant channel and try again. If you cannot obtain the vertical white bars on any channel between 52 and 69, consult your local JVC dealer.

## 3 Exit Video Channel Set Mode

Press .

To view pictures from your VCR you must now set your TV to either the Video Channel or to AV mode, depending upon your choice above.

# Tuner Set

The VCR needs to find, identify and memorise all available stations in your area in order to record programmes correctly. Once done, pressing the  or  buttons enables you to jump to the available channels without going via any vacant channels. This channel search can be done either automatically or manually. You should only need to perform either of the following procedures if Auto Setup has failed to identify and record available channels or you have moved to a new area.



## Auto Channel Setup



**GET TO THE MAIN MENU** Press .

**PERFORM AUTO CHANNEL SET** Move the highlight bar to **AUTO CH SET** using the  and  buttons and press  (or  ) twice.

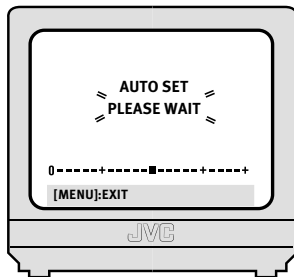
**RF AND SCART CONNECTION** If you have chosen to connect the VCR to the TV with both the RF Cable and a 21-pin SCART Cable (*not provided*) and the TV set is in its AV mode (see the TV manual), the **AUTO SET** screen will appear on the TV and remains there for about 4–12 minutes while the VCR searches for receivable stations. During Auto Channel Set the  mark on the screen moves from left to right.



The caption **SCAN COMPLETED** appears at the end of the process for about 5 seconds.

**CONFIRMATION SCREEN** Once Auto Channel Set has completed its search, the confirmation screen will appear showing the details (**PR** = *Preset Number*, **CH** = *Channel Number* and **ID** = *Station Name*) of the TV stations that the process has found. The first station will have a highlight bar over it and will be blinking. This screen and the programme currently being broadcast on the selected station will alternate at 8 second intervals. To view the next channel, press the  and  buttons to move the highlight bar to the required channel.

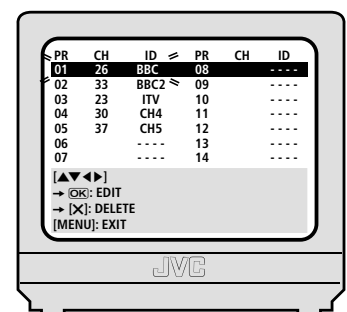
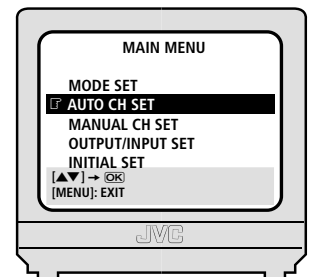

**RETURN TO NORMAL SCREEN** Press .

### NOTES ON CHANNEL RECEPTION

**INCORRECT STATION ID** In certain reception conditions, station names may not be stored correctly by the VCR and Auto Guide Program Number Set may not work properly. If the Guide Program Numbers are not set, entering a PlusCode number, may result in an incorrect channel being recorded.

**POOR RECEPTION** The VCR memorises all stations found regardless of their quality. If a station's quality is poor, you can delete that station from the memory (*see page 47*).



# Manual Channel Setup

**GET TO THE CONFIRMATION SCREEN** Press **MENU**. Move the highlight bar to **MANUAL CH SET** using the **PR/Δ** and **PR/∇** buttons and press **OK** (or **+▷**).

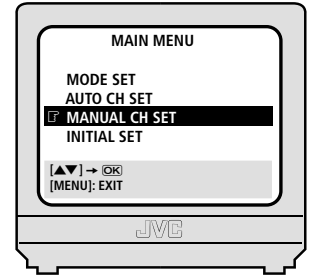

**SELECT POSITION** Use the  button on the Remote Control to move the highlight bar to a vacant position then press **OK**. In this example, we have chosen position 6.

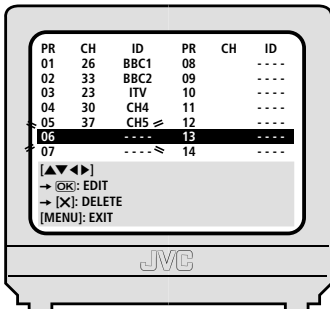

**SELECT BAND** When the **MANUAL CH SET** screen appears, press the **PR/Δ** and **PR/∇** buttons to change the band between CH (regular) and CC (cable).

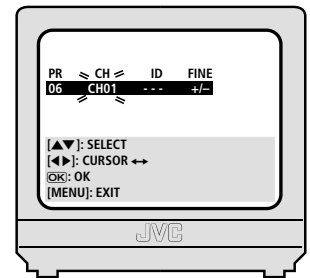

**INPUT CHANNEL NUMBER** Press the **+▷** button and you will see the channel number space flashing. Use the number keys to enter the Channel Number that you want to store.

**INPUT CHANNEL ID** Press the **+▷** button to move to the Channel ID space and use the **PR/Δ** and **PR/∇** buttons to select the required ID from the stored list.

**FINE TUNING** Press the **+▷** button repeatedly to move to the Fine Tuning '+/-' and use the **PR/Δ** and **PR/∇** buttons to fine-tune the channel. A '+' or '-' symbol will appear during this process.

**SAVE NEW CHANNEL DETAILS** Press **OK** to save the details you have just entered. The Confirmation Screen will appear again. Repeat the above procedure from **Select Position** onwards as many times as required.

**CLOSE CONFIRMATION SCREEN** Press **MENU**.



## Change Station Name

**GET TO THE CONFIRMATION SCREEN** Press **MENU**. Move the highlight bar to **MANUAL CH SET** using the **PR Δ** and **PR ∇** buttons and press **OK** (or **▶▶** **▶**).

**SELECT POSITION** Use the  button on the Remote Control to move the highlight bar to the preset position you want then press **OK** twice.

**SELECT CHARACTER** Press **▶▶** **▶** until the first letter of the station name begins blinking.

**ENTER NEW CHARACTER** Press the **PR Δ** and **PR ∇** buttons to cycle through the characters (A-Z, 0-9, -, \*, +, \_ (space)) and stop when the desired character is indicated, then press **▶▶** **▶** to enter. Enter the remaining characters the same way (maximum of 4). After entering all characters, press **OK**.

- The Confirmation screen appears.
- If you make a mistake, press **◀◀** until the incorrect character begins blinking. Then enter the correct character by pressing the **PR Δ** and **PR ∇** buttons.

**CLOSE CONFIRMATION SCREEN** Press **MENU**.

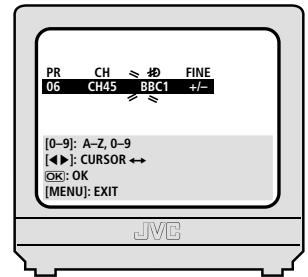

## Delete a Channel

**GET TO THE CONFIRMATION SCREEN** Press **MENU**. Move the highlight bar to **MANUAL CH SET** using the **PR Δ** and **PR ∇** buttons and press **OK** (or **▶▶** **▶**).

**SELECT CHANNEL** Use the  button on the Remote Control to move the highlight bar to the channel that you wish to delete.

**DELETE CHANNEL** Press **X**.

**RETURN TO NORMAL SCREEN** Press **MENU**.

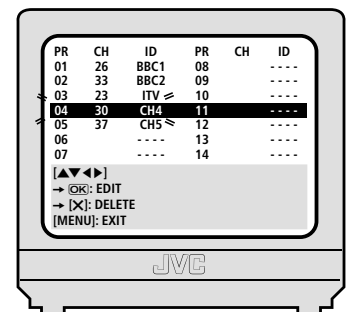







# Change Station Preset Position

**GET TO THE CONFIRMATION SCREEN** Press **[MENU]**. Move the highlight bar to **MANUAL CH SET** using the **[PR Δ]** and **[PR ∇]** buttons and press **[OK]** (or **[+]** **[D]**).

**SELECT ITEM** Use the  button on the Remote Control until the item you want to move begins blinking then press **[OK]**. The station name (ID) and its channel (CH) number begin blinking.

**SELECT NEW POSITION** Use the  button to move the station to the new preset position, then press **[OK]**.

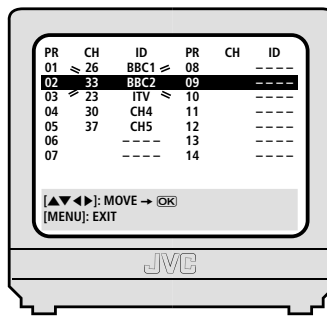
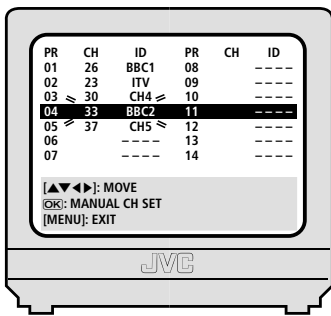

**Example: If you moved the station in position 4 to position 2, the stations originally in positions 2 and 3 each move down one space.**

**CLOSE CONFIRMATION SCREEN** Press **[MENU]**.



## Fine-Tuning Stored Channels

**GET TO THE CONFIRMATION SCREEN** Press . Move the highlight bar to **MANUAL CH SET** using the and buttons and press (or ).

**SELECT ITEM** Use the button on the Remote Control to move the highlight bar to the channel that you wish to fine-tune then press twice.

**FINE TUNING** Press the button to move to the Fine Tuning '+/-' and use the and buttons to fine-tune the channel. A '+' or a '-' symbol will appear during this process.

**SAVE NEW DETAILS** Press to save the details you have just entered. The Confirmation Screen will appear again.

**CLOSE CONFIRMATION SCREEN** Press .



## TV Station ID Guide

STATION NAME	ID
Anglia TV	ANGL
ARD	ARD
ARTE	ARTE
BBC Group	BBC
BBC1	BBC1
BBC2	BBC2
Berlin 1	BLN1
Berlin 2	BLN2
Border TV	BORD
Bayern1	BR1
Bayern3	BR3
BRT1	BRT1
BRT2	BRT2
Children Ch	CHLD
Canal +	CH+
CNN	CNN
Channel TV	CHNL
Central TV	CNTR
Channel 4	CH 4
Channel 5	CH 5
DRS	DRS
DR TV	DRTV
DSF	DSF
Euronews	EURN
Euronews	EURO
Eurosports	EURS
France1	FR1
France2	FR2
France3	FR3
Granada TV	GRNA

STATION NAME	ID
Grampian TV	GRMP
Hessen1	HR1
Hessen3	HR3
HRT	HRT
HTV	HTV
ITV Network	ITV
Kabelkanal	KABL
London	LNDN
MDR	MDR
MTV	MTV
Nord3	N3
NDR1	NDR1
NDR3	NDR3
NED1	NED1
NED2	NED2
NED3	NED3
Network 2	NET2
NRK	NRK
N-TV	N-TV
Offener Kanal	OKAN
ORF1	ORF1
ORF2	ORF2
ORF3	ORF3
OWL 3	OWL3
Premiere	PRM1
PR07	PR07
RAI1	RAI1
RAI2	RAI2
RAI3	RAI3
RB1	RB1

STATION NAME	ID
RB3	RB3
Rikisutvarpid-S	RKPS
RTBF 1	RTB1
RTBF 2	RTB2
RTE 1	RTE1
RTL	RTL
RTL 2	RTL2
RTP	RTP
SAT	SAT
SAT 1	SAT1
Scottish TV	SCOT
SC4	SC4
SDR	SDR
SDR1	SDR1
SFB1	SFB1
SFB3	SFB3
SKY	SKY
Sky One	SKY1
Sky Net	SKYN
Sport	SPRT
SR 1	SR1
Super RTL	SRTL
STV Test	STVT
STV 1	STV1
STV 2	STV2
Suedwest3	SWR
SWF 1	SWF1
Schweiz4	SWZ4
TYNE TEES	TEES
Text	TEXT

STATION NAME	ID
TF1	TF1
TNT int	TNT
TRT int	TRT
TSI	TSI
TSR	TSR
TSW	TSW
TVE	TVE
TV Polonia	TVPA
TVP 1	TVP1
TVP 2	TVP2
TVS	TVS
TV2	TV2
TV5	TV5
Tele Zurich	TZUR
Ulster TV	ULST
Veronica	VERN
VIVA	VIVA
VIVA2	VIV2
VOX	VOX
VTM	VTM
VT4	VT4
West1	WDR1
West3	WDR3
YLE 1	YLE1
YLE 2	YLE2
Yorkshire TV	YORK
ZDF	ZDF
Zurich 1	ZUR1
3SAT	3SAT



# TV Station Channel Number Guide

Region	Transmitter	BBC1	BBC2	ITV	CH4	CH5
<b>London &amp; South-East</b>	Bluebell Hill	40	46	43	65	—
	Crystal Palace	26	33	23	30	37
	Dover	50	56	66	53	—
	Heathfield	49	52	64	67	—
	Oxford	57	63	60	53	49
<b>South-West</b>	Beacon Hill	57	63	60	53	—
	Caradon Hill	22	28	25	32	—
	Huntshaw Cross	55	62	59	65	67
	Redruth	51	44	41	47	37
	Stockland Hill	33	26	23	29	—
	Channel Islands Fremont Point	51	44	41	47	—
<b>South</b>	Hannington	39	45	42	66	35
	Midhurst	61	55	58	68	—
	Rowridge	31	24	27	21	—
<b>West</b>	Mendip	58	64	61	54	37
<b>East</b>	Sandy Heath	31	27	24	21	39
	Sudbury	51	44	41	47	35
	Tacolneston	62	55	59	65	52
<b>Midlands</b>	Ridge Hill	22	28	25	32	35
	Sutton Coldfield	46	40	43	50	37
	The Wrekin	26	33	23	29	35
	Waltham	58	64	61	54	35
<b>North</b>	Belmont	22	28	25	32	56
	Emley Moor	44	51	47	41	37
<b>North-West</b>	Caldbeck	30	34	28	32	56
	Winter Hill	55	62	59	65	48
<b>North-East</b>	Bilsdale West Moor	33	26	29	23	35
	Chatton	39	45	49	42	—
	Pontop Pike	58	64	61	54	68
<b>Scotland</b>	Angus	57	63	60	53	—
	Black Hill	40	46	43	50	37
	Sandale	22	—	—	—	—
	Caldbeck	—	34	28	32	56
	Creigkelly	31	27	24	21	48
	Darvel	33	26	23	29	35
	Durris	22	28	25	32	67
	Eitshal	33	26	23	29	—
	Keelylang Hill	40	46	43	50	—
	Knock More	33	26	23	29	—
	Rosemarkie	39	45	49	42	67
	Rumster Forest	31	27	24	21	—
	Selkirk	55	62	59	65	52
	<b>Wales</b>	Blaenplwyf	31	27	24	21
Carmel		57	63	60	53	—
Llanddona		57	63	60	53	—
Moel-y-Parc		52	45	49	42	—
Presely		46	40	43	50	37
Wenvoe		44	51	41	47	—
<b>Northern Ireland</b>	Brougher Mountain	22	28	25	32	—
	Divis	31	27	24	21	37
	Limavady	55	62	59	65	—

# Clock Set

You should only need to perform this function if:

- Auto Clock Set was not performed correctly by Auto Setup, Preset Download or Auto Channel Set
- The VCR's memory backup has expired
- You want to change the Just Clock setting



## Setting the Clock

**GET TO THE INITIAL SET SCREEN** Press **MENU**. Move the highlight bar to **INITIAL SET** using the **PRAD** and **PRVE** buttons and press **OK** (or **+**, **▷**).

**GET TO THE CLOCK SET SCREEN** Move the highlight bar to **CLOCK SET** using the **PRAD** and **PRVE** buttons and press **OK** (or **+**, **▷**).

**SET TIME AND DATE** When the **CLOCK SET** screen appears, the time will be blinking. Use the **PRAD** and **PRVE** buttons to set the correct time (*pressing and holding will advance the time in 30 minute increments*) and then press **OK** (or **+**, **▷**). The date will blink. Use the **PRAD** and **PRVE** buttons to set the correct date (*pressing and holding will advance the date in 15 day increments*) and then press **OK** (or **+**, **▷**). Set the correct year in the same way and press **OK**.

**SET JUST CLOCK** Set as desired using the **PRAD** and **PRVE** buttons then press **OK** (or **+**, **▷**).

**SET PRESET FOR CLOCK DATA SOURCE** If you have set **JUST CLOCK** to **ON**, you will need to specify a preset (station) for **JUST CLOCK** to take its source data from. Use the **PRAD** and **PRVE** buttons to select the preset and press **OK** (or **+**, **▷**).

**START CLOCK OPERATION** Press **MENU**.

### NOTE:

If the recorder's memory backup has expired or the AC was disconnected from the recorder, the recorder will automatically perform Auto Clock Set when the power is restored.

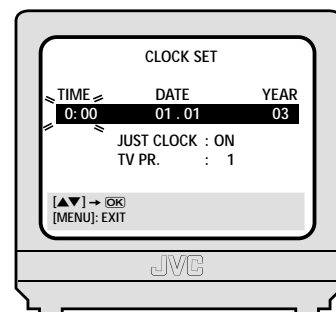

## Notes on Just Clock

Some TV stations transmit a time signal with their broadcasts. This VCR has the ability to use this signal to update its internal clock (*including the adjustment for British Summer Time*). It will do this every hour except for 23:00, 00:00, 01:00 and 02:00. By setting **Just Clock** to **ON**, you are enabling the VCR to do this.

Just Clock is not effective in the following circumstances:

- when the VCR is powered on
- when the VCR is in Timer or Auto Satellite Programme Recording modes
- when a difference of more than 3 minutes between the internal clock and the time signal exists.
- when reception conditions are poor.

# Question and Answers

## PLAYBACK

**Q:** What happens if the end of the tape is reached during playback or search?

**A:** *The tape is automatically rewound to the beginning.*

**Q:** Can the VCR indefinitely remain in the still mode?

**A:** *No. It stops automatically after 5 minutes to protect the heads.*

**Q:** During search, slow, still and frame-by-frame playback, I can't hear any audio.

What's the problem?

**A:** *This is normal.*

**Q:** When returning from variable-speed search to normal playback, the picture is disturbed. Should I be concerned about this?

**A:** *No, it is normal.*

**Q:** Noise bars appear during variable-speed search. What's the problem?

**A:** *This is normal.*

**Q:** Sometimes, during Index Search, the VCR can't find the programme I want to see. Why not?

**A:** *There may be index codes too close together.*

## RECORDING

**Q:** When I pause and then resume a recording, the end of the recording before the pause is overlapped by the beginning of the continuation of recording. Why does this happen?

**A:** *This is normal. It reduces distortion at the pause and resume points.*

**Q:** Can the VCR indefinitely remain in the Record-Pause mode?

**A:** *No. The VCR shuts off automatically after 5 minutes to protect the heads.*

**Q:** What happens if the tape runs out during recording?

**A:** *The VCR stops recording, then if Timer Recording, the VCR shuts off.*

## TIMER RECORDING

**Q:** ○ and ⊖ remain lit on the display panel. Is there a problem?

**A:** *No. This is a normal condition for a timer recording in progress.*

**Q:** Can I programme the timer while I'm watching a tape or a TV broadcast?

**A:** *You won't see the picture as it is replaced by the on-screen menu, but the audio from the program or tape you're viewing can be heard.*

# Troubleshooting

SYMPTOM	POSSIBLE CAUSE	CORRECTIVE ACTION
<b>POWER</b>		
1. No power is applied to the VCR.	<ul style="list-style-type: none"> <li>The mains power cord is disconnected.</li> </ul>	Connect the mains power cord.
2. The clock is functioning properly, but the VCR cannot be powered.	<ul style="list-style-type: none"> <li>⊖ is displayed on the display panel with <b>AUTO TIMER</b> set to <b>OFF</b>.</li> </ul>	Press the ⊖ button to turn the ⊖ indicator off.
3. The Remote Control won't function.	<ul style="list-style-type: none"> <li>The battery is discharged.</li> </ul>	Replace the dead battery with a new one.
<b>TAPE TRANSPORT</b>		
1. The tape does not run during recording. ○ lights up and preset position blinks on the display panel.	<ul style="list-style-type: none"> <li>The VCR is in the <b>RECORD PAUSE MODE</b>.</li> </ul>	Press ► to resume recording.
2. The tape will not rewind or fast-forward.	<ul style="list-style-type: none"> <li>The tape is already fully rewound or fast-forwarded.</li> </ul>	Check the cassette.
<b>PLAYBACK</b>		
1. The playback picture does not appear while the tape is running.	<ul style="list-style-type: none"> <li>If you're using only the RF cable for connection... ...the TV's channel selector is not set to the Video Channel. ...the VCR's Video Channel has not been correctly set.</li> <li>If you're using both the RF cable and 21-pin SCART cable for connection, the TV is not set to the AV mode.</li> </ul>	<p>If you are using only the RF cable for connection... ...set the TV to the Video Channel. ...Perform <b>Video Channel Set</b>. (☞ pg. 44)</p> <p>If you are using both the RF cable and 21-pin SCART cable for connection, set the TV to its AV mode.</p>
2. Noise appears during visual search.	<ul style="list-style-type: none"> <li>This is normal.</li> </ul>	
3. Noise appears during normal playback.	<ul style="list-style-type: none"> <li>The automatic tracking mode is engaged.</li> </ul>	Try manual tracking. (☞ pg. 28)
4. The playback picture is blurred or interrupted while TV broadcasts are clear or <b>USE CLEANING CASSETTE</b> message appears on the screen.	<ul style="list-style-type: none"> <li>The video heads may be dirty.</li> </ul>	Use a dry cleaning cassette JVC TCL-2 or consult your JVC dealer.
5. Breaks are noticeable in Hi-Fi soundtrack.	<ul style="list-style-type: none"> <li>Automatic tracking is engaged.</li> </ul>	Try manual tracking (☞ pg. 28) or press <b>AUDIO</b> to change the soundtrack to <b>NORM</b> (☞ pg. 33).

SYMPTOM	POSSIBLE CAUSE	CORRECTIVE ACTION
<b>RECORDING</b>		
1. Recording cannot be started.	<ul style="list-style-type: none"> <li>There is no cassette loaded, or the cassette loaded has had its record safety tab removed.</li> </ul>	Insert a cassette, or using adhesive tape, cover the hole where the tab was removed.
2. TV broadcasts cannot be recorded.	<ul style="list-style-type: none"> <li>L-1 or L-2 has been selected as the input mode.</li> </ul>	Set to the desired preset.
3. Tape-to-tape editing is not possible.	<ul style="list-style-type: none"> <li>The source (another VCR, camcorder) has not been properly connected.</li> <li>All necessary power switches have not been turned on.</li> <li>The input mode is not correct.</li> </ul>	<p>Confirm that the source is properly connected.</p> <p>Confirm that all units' power switches are turned on.</p> <p>Set the input mode to L-1 or L-2.</p>
4. Camcorder recording is not possible.	<ul style="list-style-type: none"> <li>The camcorder has not been properly connected.</li> <li>The input mode is not correct.</li> </ul>	<p>Confirm that the camcorder is properly connected.</p> <p>Set the input mode to L-1 or L-2.</p>
<b>TIMER RECORDING</b>		
1. Timer recording won't work.	<ul style="list-style-type: none"> <li>The clock and/or the timer have been set incorrectly.</li> <li>The timer is not engaged.</li> </ul>	<p>Re-perform the clock and/or timer settings.</p> <p>Press ⊖ and confirm that ⊖ is displayed on the display panel.</p>
2. Timer programming is not possible.	<ul style="list-style-type: none"> <li>Timer recording is in progress.</li> </ul>	Timer programming can't be performed while a timer recording is in progress. Wait until it finishes.
3. ⊖ on the display panel won't stop blinking.	<ul style="list-style-type: none"> <li>The timer is engaged but there's no cassette loaded.</li> </ul>	Load a cassette with the record safety tab intact.
4. ⊖, ○ and ▷ on the display panel won't stop blinking.	<ul style="list-style-type: none"> <li>The loaded cassette has had its record safety tab removed.</li> <li>The end of the tape was reached during timer recording.</li> </ul>	<p>Remove the cassette and cover the hole with adhesive tape, or insert a cassette with the record safety tab intact.</p> <p>The programme may not have been recorded in its entirety. Next time make sure you have enough time on the tape to record the entire programme.</p>
5. ⊖ blinks for 10 seconds and the Timer mode is disengaged.	<ul style="list-style-type: none"> <li>⊖ has been pressed when there are no programs in memory, or the timer record information has been programmed incorrectly.</li> </ul>	Check the programmed data and re-programme as necessary, then press ⊖ again.
6. The VIDEO Plus+ system does not timer record properly.	<ul style="list-style-type: none"> <li>The VCR's preset positions have been set incorrectly.</li> </ul>	Refer to <b>Set Guide Program Numbers</b> (📖 pg. 22) and re-perform the procedure.

SYMPTOM	POSSIBLE CAUSE	CORRECTIVE ACTION
<b>TIMER RECORDING (CONT.)</b>		
7. ○, ▷ and the SAT ⊕ indicator won't stop blinking.	<ul style="list-style-type: none"> <li>• The loaded cassette has had its record safety tab removed.</li> </ul>	Remove the cassette and cover the hole with adhesive tape, or insert a cassette with the record safety tab intact.
	<ul style="list-style-type: none"> <li>• The end of the tape was reached during Auto Satellite Programme Recording.</li> </ul>	The programme may not have been recorded in its entirety. Next time make sure you have enough time on the tape to record the entire programme.
8. ○ and ▷ on the display panel won't stop blinking.	<ul style="list-style-type: none"> <li>• The end of the tape was reached during Instant Timer Recording.</li> </ul>	The programme may not have been recorded in its entirety. Next time make sure you have enough time on the tape to record the entire programme.
<b>OTHER PROBLEMS</b>		
1. Whistling or howling is heard from the TV during camcorder recording.	<ul style="list-style-type: none"> <li>• The camcorder's microphone is too close to the TV.</li> <li>• The TV's volume is too high.</li> </ul>	Position the camcorder so its microphone is away from the TV. Turn the TV's volume down.
2. When scanning channels, some of them are skipped over.	<ul style="list-style-type: none"> <li>• Those channels have been designated to be skipped.</li> </ul>	If you need the skipped channels, restore them.
3. The preset cannot be changed.	<ul style="list-style-type: none"> <li>• Recording is in progress.</li> </ul>	Press <b>  </b> to pause the recording, change presets, then press <b>▶</b> to resume recording.
4. Channel settings that were made manually seem to have changed or disappeared.	<ul style="list-style-type: none"> <li>• After the manual settings were made, Auto Channel Set was performed.</li> </ul>	Perform manual setting again.
5. No channels are stored in the VCR's memory.	<ul style="list-style-type: none"> <li>• The TV aerial cable was not connected to the VCR when Auto Set Up was performed.</li> </ul>	Turn off the VCR once and connect the TV aerial cable to the VCR properly, then turn on the VCR again. Then perform <b>Auto Setup</b> again (☞ pg. 10).



# List of Terms

<b>A</b>		<b>N</b>	
Auto Channel Setup .....	46	Next Function Memory .....	43
Auto Satellite Program Recording .....	35	NICAM Stereo and Bilingual Broadcasts .....	33
Auto Power .....	43	NTSC Tapes .....	14
Auto Setup .....	11	<b>O</b>	
Auto SP → LP Timer .....	42	On-Screen Display (O.S.D.) .....	41
Auto Timer .....	43	<b>P</b>	
<b>B</b>		Pause During Playback .....	16
B.E.S.T. ....	32	Picture Control .....	29
<b>C</b>		Playback .....	14
Change Station Name .....	48	PlusCode Number .....	21
Change Station Preset Position .....	49	Power Save Mode .....	42
Clock Set .....	52	<b>R</b>	
Connection to a Stereo System .....	44	Record a Programme While Watching Another ....	19
Counter Display .....	19, 41	Recording .....	18
<b>D</b>		Recording Resume Function .....	20
Delete a Channel .....	48	Repeat Playback .....	43
<b>E</b>		<b>S</b>	
Editing .....	37	S-VHS .....	31
Editing Using Another VCR .....	39	S-VHS ET .....	30
Express Timer Programming .....	24	Single Frame Movement .....	16
<b>F</b>		Skip Search .....	34
Fine-Tuning Stored Channels .....	50	Slow Motion .....	17
<b>H</b>		Soundtrack Selection .....	33
High Speed Search .....	17	<b>T</b>	
<b>I</b>		Tape Remaining Time . ....	19, 41
Index Search .....	34	Tuner Set .....	46
Instant ReView .....	34	TV Station Channel Number Guide .....	51
Instant Timer Recording .....	20	TV Station ID Guide .....	50
<b>J</b>		<b>V</b>	
Just Clock .....	52	Variable Speed Search .....	17
<b>L</b>		Video Channel Set .....	45
L-1 OUTPUT .....	37	Video Heads Cleaning .....	15
L-2 INPUT .....	38	VIDEO Plus+® Timer Programming .....	21
<b>M</b>		Video Stabilizer .....	28
Manual Channel Setup .....	47		
Manual Tracking .....	28		





## SPECIFICATIONS

### GENERAL

Power requirement : AC 220 V – 240 V  $\sim$ , 50 Hz/60 Hz  
 Power consumption : on : 16 W, off : 3.5 W  
 Operating Temperature : 5°C to 40°C  
 Storage Temperature : -20°C to 60°C  
 Operating position : Horizontal only  
 Dimensions (WxHxD) : 400 mm x 94 mm x 270 mm  
 Weight : 3.1 kg  
 Format : S-VHS, VHS PAL standard  
 Maximum recording time :  
 (SP) : 240 min. with E-240 video cassette  
 (LP) : 480 min. with E-240 video cassette

### VIDEO / AUDIO

Signal system : PAL-type colour signal and CCIR monochrome signal, 625 lines/50 fields  
 Recording system : DA4 (Double Azimuth) helical scan system  
 Signal-to-noise ratio : 45 dB  
 Horizontal resolution : 250 lines (VHS)  
 400 lines (S-VHS)  
 Frequency range : 70 Hz to 10,000 Hz (Normal audio)  
 20 Hz to 20,000 Hz (Hi-Fi audio)  
 Input/Output : 21-pin SCART connectors  
 (IN/OUT x 1, IN x 1)  
 RCA connectors  
 (AUDIO OUT x 1)

### TUNER / TIMER

TV channel storage capacity : 99 positions (+AUX position)  
 Tuning system : Frequency synthesized tuner  
 Channel coverage : VHF 44.5 MHz – 143 MHz/  
 143 MHz – 470 MHz/  
 UHF 470 MHz – 862 MHz  
 Aerial output : UHF channels 22 – 69 (Adjustable)  
 Memory backup time : Approx. 10 min.

### ACCESSORIES

Provided accessories : RF cable, Infrared remote control unit, Lithium Battery (CR-2032)

Specifications shown are for SP mode unless otherwise specified.  
 E.& O.E. Design and specifications subject to change without notice.

**JVC**  
 VICTOR COMPANY OF JAPAN, LIMITED

## Free Manuals Download Website

<http://myh66.com>

<http://usermanuals.us>

<http://www.somanuals.com>

<http://www.4manuals.cc>

<http://www.manual-lib.com>

<http://www.404manual.com>

<http://www.luxmanual.com>

<http://aubethermostatmanual.com>

Golf course search by state

<http://golfingnear.com>

Email search by domain

<http://emailbydomain.com>

Auto manuals search

<http://auto.somanuals.com>

TV manuals search

<http://tv.somanuals.com>