

JVC®

VIDEO CASSETTE RECORDER

SR-9168U

INSTRUCTIONS



TIMELAPSE

Thank you for purchasing this JVC product. Before operating this unit, please read the instructions carefully to ensure the best possible performance.

This instruction book is made from 100% recycled paper.

For Customer Use:

Enter below the Serial No. which is located on the rear of cabinet. Retain this information for future reference.

Model No. SR-9168U

Serial No. _____

INTRODUCTION

CONTROLS AND CONNECTORS

CONNECTIONS

MONITOR ON-SCREEN DISPLAY

SETTING OF THE FUNCTION MENU SWITCHES

PREPARATION

RECORDING



PLAYBACK AND SPECIAL-EFFECTS PLAYBACK

TROUBLE-SHOOTING

OPTIONAL SA-K97U RS-232C INTERFACE BOARD

APPENDICES

SAFETY PRECAUTIONS

	CAUTION RISK OF ELECTRIC SHOCK DO NOT OPEN	
<p>CAUTION: TO REDUCE THE RISK OF ELECTRIC SHOCK, DO NOT REMOVE COVER (OR BACK). NO USER-SERVICEABLE PARTS INSIDE. REFER SERVICING TO QUALIFIED SERVICE PERSONNEL</p>		

	ATTENTION RISQUE D'ELECTROCUTION NE PAS OUVRIR	
<p>ATTENTION: POUR EVITER TOUT RISQUE D'ELECTROCUTION NE PAS OUVRIR LE BOITIER. AUCUNE PIECE INTERIEURE N'EST A REGLER PAR L'UTILISATEUR. SE REFERER A UN AGENT QUALIFIE EN CAS DE PROBLEME.</p>		



The lightning flash with arrowhead symbol, within an equilateral triangle, is intended to alert the user to the presence of uninsulated "dangerous voltage" within the product's enclosure that may be of sufficient magnitude to constitute a risk of electric shock to persons.



The exclamation point within an equilateral triangle is intended to alert the user to the presence of important operating and maintenance (servicing) instructions in the literature accompanying the appliance.



Le symbole de l'éclair à l'intérieur d'un triangle équilatéral est destiné à alerter l'utilisateur sur la présence d'une "tension dangereuse" non isolée dans le boîtier du produit. Cette tension est suffisante pour provoquer l'électrocution de personnes.



Le point d'exclamation à l'intérieur d'un triangle équilatéral est destiné à alerter l'utilisateur sur la présence d'opérations d'entretien importantes au sujet desquelles des renseignements se trouvent dans le manuel d'instructions.

*Ces symboles ne sont utilisés qu'aux Etats-Unis.

WARNING:
TO REDUCE THE RISK OF FIRE OR ELECTRIC SHOCK, DO NOT EXPOSE THIS APPLIANCE TO RAIN OR MOISTURE.

This unit should be used with 120 V AC only.

CAUTION:
To prevent electric shocks and fire hazards, do NOT use any other power source.

NOTE:

The rating plate (serial number plate) is on the rear of the unit.

INFORMATION

This equipment has been tested and found to comply with the limits for a Class B digital device, pursuant to Part 15 of the FCC Rules. These limits are designed to provide reasonable protection against harmful interference in a residential installation. This equipment generates, uses, and can radiate radio frequency energy and, if not installed and used in accordance with the instructions, may cause harmful interference to radio communications. However, there is no guarantee that interference will not occur in a particular installation. If this equipment does cause harmful interference to radio or television reception, which can be determined by turning the equipment off and on, the user is encouraged to try to correct the interference by one or more of the following measures:

- Reorient or relocate the receiving antenna.
- Increase the separation between the equipment and receiver.
- Connect the equipment into an outlet on a circuit different from that to which the receiver is connected.
- Consult the dealer or an experienced radio/TV technician for help.

CAUTION

CHANGES OR MODIFICATIONS NOT APPROVED BY JVC COULD VOID USER'S AUTHORITY TO OPERATE THE EQUIPMENT.

THIS DEVICE COMPLIES WITH PART 15 OF THE FCC RULES. OPERATION IS SUBJECT TO THE FOLLOWING TWO CONDITIONS: (1) THIS DEVICE MAY NOT CAUSE HARMFUL INTERFERENCE, AND (2) THIS DEVICE MUST ACCEPT ANY INTERFERENCE RECEIVED, INCLUDING INTERFERENCE THAT MAY CAUSE UNDESIRED OPERATION.

AVERTISSEMENT:
POUR EVITER LES RISQUES D'INCENDIE OU D'ELECTROCUTION, NE PAS EXPOSER L'APPAREIL A L'HUMIDITE OU A LA PLUIE.

Ce magnéscope ne doit être utilisé que sur du courant alternatif en 120 V.

ATTENTION:
Afin d'éviter tout risque d'incendie ou d'électrocution, ne pas utiliser d'autres sources d'alimentation électrique.

REMARQUE:

La plaque d'identification (numéro de série) se trouve sur le panneau arrière de l'appareil.

WARNING:

The battery used in the SR-9168U must be replaced at the JVC authorized service dealer only.

This digital apparatus does not exceed the Class B limits for radio noise emissions from digital apparatus as set out in the interference-causing equipment standard entitled "Digital Apparatus", ICES-003 of the Department of Communications.

Cet appareil numérique respecte les limites de bruits radioélectriques applicables aux appareils numériques de Classe B prescrites dans la norme sur le matériel brouilleur: "Appareils Numériques", NMB-003 édictée par le ministre des Communications.

CONTENTS

1 INTRODUCTION

- 1-1 Major Features 4
- 1-2 Periodical Maintenance 4
- 1-3 Precautions 5
- 1-4 Daily Inspection 5

2 CONTROLS AND CONNECTORS

- 2-1 Front Panel 6
- 2-2 Display 8
- 2-3 Rear Panel 9

3 CONNECTIONS

- 3-1 Connecting to a Camera 11
- 3-2 Connecting a System Using a Sequential Switcher 12
- 3-3 Connecting the Rear Panel Input/Output Terminal Connections 13

4 MONITOR ON-SCREEN DISPLAY

- 4-1 On-Screen Display in the Time/Date and Record Mode 14
- 4-2 Main Menu Display 15
- 4-3 Alarm Input/Power Loss Data Display 16
- 4-4 Hour Meter Display 16

5 SETTING OF THE FUNCTION MENU SWITCHES

- 5-1 Function Menu Switch Setting 17
- 5-2 Contents of the Function Menu Switches 18

6 PREPARATION

- 6-1 Cassette Loading/Unloading 21
- 6-2 Date and Time setting 21
- 6-3 Summer Time Compensation 23
- 6-4 Selection of Record/Play Mode 23

7 RECORDING

- 7-1 Preparation 24
- 7-2 Recording 25
- 7-3 Timer Recording 26
- 7-4 Alarm Recording 31
- 7-5 Sensor Recording 33
- 7-6 Repeat Recording 34
- 7-7 Series Recording 35
- 7-8 Recording with External VCR Activation Signal 36
- 7-9 How to Restore Recording After Power Failure 37
- 7-10 External Timer Recording 37
- 7-11 Tape End Buzzer 37

8 PLAYBACK AND SPECIAL-EFFECTS PLAYBACK

- 8-1 Preparation 38
- 8-2 Playback 38
- 8-3 Special-Effects Playback 39
- 8-4 Index Search 40
- 8-5 Tracking/V. Lock Adjustment 40

9 TROUBLESHOOTING

- 9-1 Error Indication 41
- 9-2 No Error Indication 42

10 OPTIONAL SA-K97U RS-232C INTERFACE BOARD

- 10-1 Installation of the SA-K97U 43
- 10-2 SA-K97U Specifications..... 44
- 10-3 SA-K97U RS-232C Protocol & Commands..... 45

11 APPENDIXES

- 11-1 Rear Panel's Input/Output 52
- 11-2 Specifications 53

The SR-9168U is a video cassette recorder able to execute timelapse recording with VHS cassettes.

Use only video cassettes bearing the **VHS** mark.

This unit is designed for professional use.

JVC is not liable for compensation for loss or damage to recordings in the event this unit fails to record or play back properly because the unit malfunctions or a defective video cassette tape is used.

Please note that it may be unlawful to use any material recorded from TV broadcast programs or pre-recorded programs without the consent of the owner of copyright, except in cases where this material is recorded exclusively for personal use.

1 INTRODUCTION

1-1 Major Features

- **240-hour long-time recording with a 120-minute tape**
Recording times are selectable from 6 hours (EP mode) and L18/L30/48/72/96/120/168/240 hours (Timelapse mode). Monitor image recording for up to 240 hours is possible with a 120-minute tape.
- **Audio monitoring**
Audio signals can be recorded in the 18-hour/30-hour Timelapse mode, as well as in the conventional 6-hour mode. This strengthens surveillance capabilities by providing both audio and video information.
- **Alarm recording function**
When an alarm signal is input in the Timelapse Record mode, the 6-hour (EP), 18-hour or 30-hour mode is automatically engaged. Alarm recording time can be selected from 5, 15, 30, 60, 120, or 180 sec., to tape end or set manually. An index code is automatically recorded when alarm recording starts. Used as an alarm cue signal, this allows quick access to alarm recording points with the Index Search function.
- **Sensor recording**
Whenever an alarm signal is input in the Stop mode, the Record mode is automatically engaged.
- **Time/date generator**
Superimposes the year, month, date, minute and second on the image during recording. Also allows you to use the menu screen to display the number of alarms, alarm time, and the number of the power failures.
- **Timer recording function**
Two types of timer recording are available: based on the date (up to 8 programs) or based on the day of the week.
- **Recording Check function**
Pressing the [REC CHECK] button during recording allows you to check the status of the recording in progress. When activated via the corresponding function menu switch, the built-in head cleaner automatically cleans the heads whenever inferior picture quality is detected during Recording Check. After cleaning, the Recording Check operation is executed again automatically (Auto Recording Check function).
- **Operation lock system**
To prevent accidental or deliberate interference with VCR operation, the operation lock system is provided.
- **Warning function**
Error indications are shown on the front panel display.
- **Power-off video throughput function**
Even when the power is off, the camera's EE input can be output from the VCR.
- **Camera switching signal output terminal**
- **Automatic re-start of recording after a power failure**
- **Digital hour meter display**
- **Repeat recording/series recording function**
- **Recording control with external activation signal**
- **Alarm recording, tape end and warning electronic buzzer**
- **Summer time compensation function**
- **Wired remote control (optional)**
- **RS-232C control (with optional SA-K97U RS-232C interface board installed)**
The SR-9168U can be controlled via a personal computer. Operation status can be monitored on the computer.

1-2 Periodical Maintenance

This VCR incorporates precision mechanical parts which will collect dirt over time and ultimately deteriorate and wear out. Over long periods of use, dirt and dust accumulates on the heads, drums and tape transport mechanisms. Dust which penetrates the VCR (especially during outdoor use) also promotes the wear and deterioration of mechanical parts by causing poor contact between tape and heads. This also prevents the VCR from maintaining video and audio quality at high levels. To prevent wear and deterioration, clean the heads regularly using a head cleaning tape. However, because a head cleaning tape alone cannot clean the entire tape transport mechanism, this should also be inspected periodically to prevent any problems that could result from a sudden failure.

As replacement and adjustment of parts require advanced skills and specialized equipment, please contact the person in charge of professional video equipment at your nearest JVC-authorized service agent for servicing.

Monitoring Usage Time

The total operation time reached by an ordinary home VCR in 5 or 6 years may be reached by a professional VCR in as few as 5 or 6 months. Therefore, it is important that the total hours of operation be carefully monitored. An hour meter in the on-screen display (see page 16) shows the accumulated time. In the chart below, the hours accumulated in each month are shown in relation to the number of hours used per day. Times shown inside shaded area indicate that maintenance should be performed.

Usage time per day	1 month	2 months	3 months	6 months	12 months
2 hours	60	120	180	360	720
8 hours	240	480	720	1440	2880
12 hours	360	720	1080	2160	4320
24 hours	720	1440	2160	4320	8640

Periodic Maintenance

Check or replace the following mechanical parts according to the running time.

Running time	1000H	2000H	3000H	4000H
Drum ass'y (including heads)	△	○	○	●
Pinch rollers	△	○	○	●
Drive parts	△	△	△	○

- △ : Cleaning
- : Check or replace as required.
- : Replace

- Maintenance requirements may vary depending on the operating environment and usage. The information above should be used as a reference guide.

1 INTRODUCTION

1-3 Precautions

Handling and storage place

- **Avoid using the unit in places subject to the following conditions:**
 - extreme heat or cold
 - strong magnetic fields (do not use a transceiver within 2 meters of this unit)
 - high humidity
 - dust and soil
 - vibrations
 - variations in temperature
- **Use this unit in horizontal (flat position) only.**
- **Do not leave the unit in the Still or Record Pause mode for a long time as this may damage the tape.**

To minimize tape damage, this VCR automatically enters the Stop mode after about 5 minutes have passed in the Still or Record Pause mode.
- **Handle the unit carefully**
 - Do not place anything heavy on the unit (a monitor, etc.). A malfunction may occur.
 - Do not put any foreign substance into the cassette loading slot.
 - Avoid violent shocks to the recording chassis during transportation. Remove the cassette tape from the unit for transportation.
- Turn off the power to save electricity when not using the unit.

Condensation

- **Condensation**

When cold beer is poured into a glass, water drops appear on the glass's surface. This phenomenon is called "condensation". When condensation occurs on the VCR's head drum and tape guides it may damage the tape.
- **Condensation occurs in the following cases.**
 - When the VCR is moved from a cold place to a warm place.
 - In a room that has just been heated or in an area directly exposed to a cooler.
 - When there is excessive humidity
- **When condensation is expected to occur**

Turn the power of the VCR on before use.

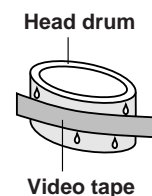

Video cassette

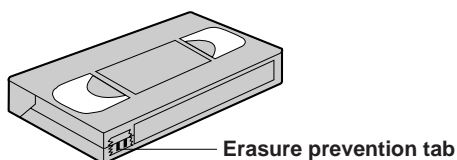

Timelapse recording is performed over very long periods of time which means that a durable tape is required.

- Use a T-120 tape or shorter.
- Do not use extended tapes (130 minutes or more such as T-130).

- Only use video cassette bearing the **VHS** mark.
- To prevent accidental erasure of a recorded tape, break the erasure prevention tab on the cassette. To use a cassette with a broken tab, place a piece of cellophane tape over the broken tab.
- Video cassettes cannot be used upside down.
- Leaving the tape in a partially wound condition for a long time may damage the tape. Rewind the tape to the beginning before storage.

1-4 Daily Inspection

Although this unit has been designed for reliable operation over a long period of time, a daily inspection is recommended to ensure optimum performance. In particular, be sure to check the repeat recording function on a daily basis.

Inspection procedure

- 1 Turn on the power for all units connected to the surveillance system.
- 2 Check the quality of the image shown on the monitor.
- 3 Check that the date and time shown on the monitor are correct.

- 4 Rewind the tape recorded the previous day for several seconds.
- 5 Press the play button for playback.
- 6 Check that the playback picture is normal.
- 7 Check that the recorded date and time are correct.
 - This unit includes a Recording Check function (using the [REC CHECK] button) and an Automatic Recording Check function for daily checking of recording quality.

If any problems are found after inspection, turn the power off, unplug the power plug from the AC outlet, and contact your JVC dealer.

2 CONTROLS AND CONNECTORS

2-1 Front Panel

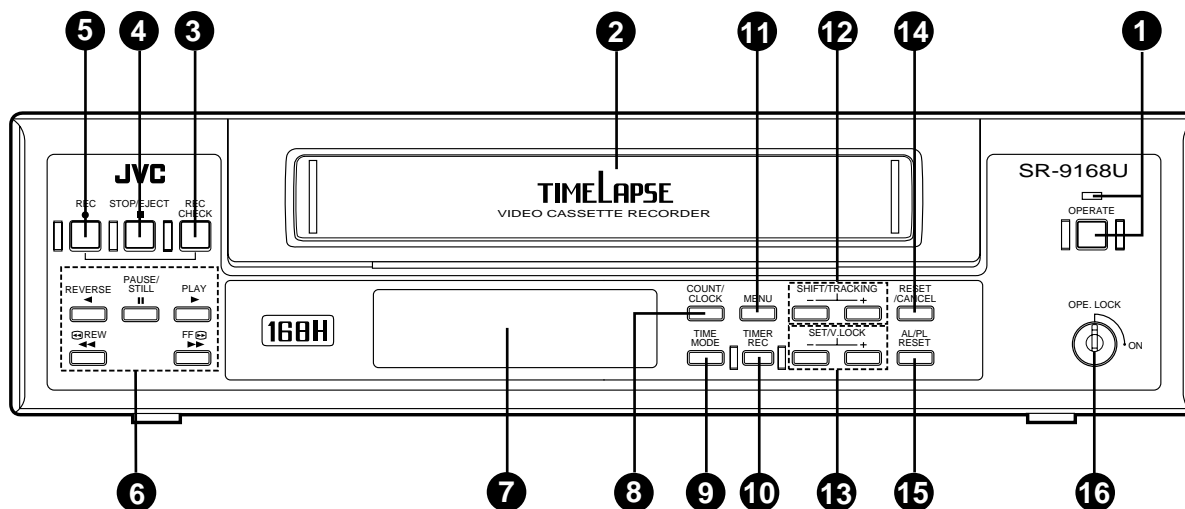

1 [OPERATE] button

Press to turn the operating power ON/OFF. When this button is ON, the OPERATE indicator lights and the unit can be operated. When a cassette is inserted, the power switches on and the OPERATE indicator lights automatically.

The OPERATE button does not completely shut off the mains power to the unit, but switches the operating current on and off.

2 Cassette loading slot

For cassette loading and unloading. Use a VHS cassette tape.

3 [REC CHECK] button

Use to check recording.

When pressed in the Record mode, this will rewind the tape about 5 seconds and then play back the rewind section so that the recording quality can be checked. After playback, the Record mode is automatically re-engaged at the point where recording was interrupted.

- The FM level is checked during playback in Recording. Check operation to determine whether or not picture quality is defective. If it is judged defective, the heads are automatically cleaned. How this operation is performed is determined by the setting of the [REC CHECK] switch in the function menu.

– When set to "MANUAL":

Head cleaning is performed once and recording resumes.

– When set "AUTO":

Head cleaning is performed once and recording is resumed for several seconds. Then, Recording Check operation is performed again.

If picture quality is again judged defective, head cleaning is performed once again and "E-09" is shown on the display to indicate that there is a problem. Recording will continue, however.

4 [STOP/EJECT] button

- Stops the tape.
- Ejects the tape when pressed in the Stop mode.

5 [REC] button

Starts recording when pressed in the Stop mode.

6 Operation buttons

[PLAY] button

Starts playback.

[PAUSE/STILL] button

- Temporarily stops recording when pressed in the Record mode.
- Displays a still picture when pressed in the Play mode.
- Advances field by field when pressed in the Still mode.

[REVERSE] button

Starts reverse playback when pressed in the Play or Still mode.

[FF] button

- Fast forwards the tape.
- Starts fast-forward shuttle search when pressed in the Play mode.
- If the function menu switch <INDEX SEARCH> is set to ON and an alarm-recorded tape is loaded, Index (alarm) Search starts in the forward direction when this button is pressed in the Stop or Play mode.

[REW] button

- Rewinds the tape.
- Starts reverse shuttle search when pressed in the Play mode.
- If the function menu switch <INDEX SEARCH> is set to ON and an alarm-recorded tape is loaded, Index (alarm) Search starts in the reverse direction when this button is pressed in the Stop or Play mode.

2 CONTROLS AND CONNECTORS

2-1 Front Panel

7 Display section

For details, refer to page 8.

8 [COUNT/CLOCK] button

Press this button to select the time display or tape counter in the display.

When the power is turned off, the time is displayed.

9 [TIME MODE] button

Use to select the recording or playback time mode.

Each time this button is pressed, the recording/playback time mode changes in the following sequence.

6H(EPmode) → L18 → L30H → 48H → 72H → 96H → 120H → 168H → 240H → 6H (EP mode)

The selected recording/playback time mode is shown on the display.

10 [TIMER REC] button

Press this button to execute the timer recording. For details, refer to "Timer Recording" on page 26.

11 [MENU] button

Press this button to display the date, time setting, timer program setting, various function menu setting and hour meter. Press again to cancel the display.

12 [SHIFT/TRACKING +, -] buttons

- Press to select an item in date/time setting, timer program setting and function menu setting.
- Press to adjust tracking and reduce noise if there are tracking problems in the play back mode or during search.

13 [SET/V. LOCK +, -] buttons

- Press to set values in date/time setting, timer program setting and function menu setting.
- Press to reduce the vertical shifting of the picture in the Still mode.

14 [RESET/CANCEL] button

- Normally press this button to reset the tape counter to 0000.
- When the buzzer sounds, press this button to stop the buzzer sound.
- In the Timer Program Setting mode, press this button to cancel the program settings. For details, refer to "Timer Recording" on page 29.

15 [AL/PL RESET] alarm/power loss reset button

Press this button to stop alarm recording or reset the alarm input or power loss data. For details, refer to page 32.

16 [OPE. LOCK] key

Insert the provided key into this key hole and turn it to "ON" to lock the VCR in its current mode and disable all controls.

When operation Lock mode is engaged, "LOCK" is shown on the display.

2 CONTROLS AND CONNECTORS

2-2 Display

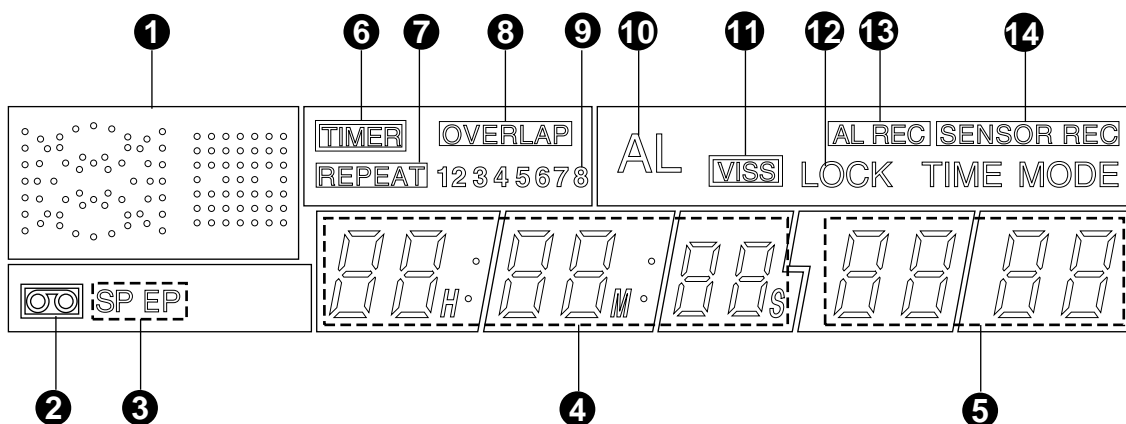

1 Operation mode display

Shows the operation modes.

Playback	Recording	Rewind	Fast-forward	Timelapse playback
Still	Record-pause	Rewind search	Fast-forward search	Reverse playback

* (○) mark in the Rec/Pause mode is shown in red.

2 Cassette indication

Lights when a cassette is loaded. Blinks when a cassette is being ejected.

3 SP/EP indication

Shows the VHS standard (SP) mode or VHS extended mode (EP) during recording/playback. During 6H (EP) and Timelapse Recording/Playback mode, the EP indicator is shown. Recording in the SP mode is not possible with this unit.

4 Tape counter/time indication

- When the power is turned on, the tape counter or current time are shown. The display can be selected with the [COUNT/CLOCK] button.
- When the power is turned off, the present time (hour, minute, second) is shown.

5 Recording/playback mode time display

- Shows the recording/playback mode set with the [TIME MODE] button.
- When a tape ends in the Record mode, the record time mode indication goes out and the "End" indication blinks (when the <REC REMAIN> menu switch is set to "OFF"). If the <REC REMAIN> menu switch is set to "180S" or "360S", the "End" indication blinks 3 minutes or 6 minutes before the tape ends during 6H mode.
- When an problem occurs, the error indication "E-**"

blinks. For details, refer to page 41.

6 TIMER indication

Lights during timer recording programming/operation.

7 REPEAT indication

Lights when the VCR is in the Repeat Record mode.

8 OVERLAP indication

Blinks when programs scheduled for timer recording overlap.

9 Timer program number

During timer recording, the number of program being recorded blinks. When the timer recording ends, this number goes out.

10 AL (alarm) indication

Shown during alarm recording. Blinks when alarm recording ends.

11 VISS indication

Shown when the alarm recording start point is index-searched. For details, refer to "Index Search" on page 40.

12 LOCK indication

Lights when the operation lock function is activated.

13 AL REC (alarm recording) indication

Lights when the function menu switch <ALARM REC> is set to "ON".

14 SENSOR REC (sensor recording) indication

Lights when the function menu switch <SENSOR REC> is set to "ON".

2 CONTROLS AND CONNECTORS

2-3 Rear Panel

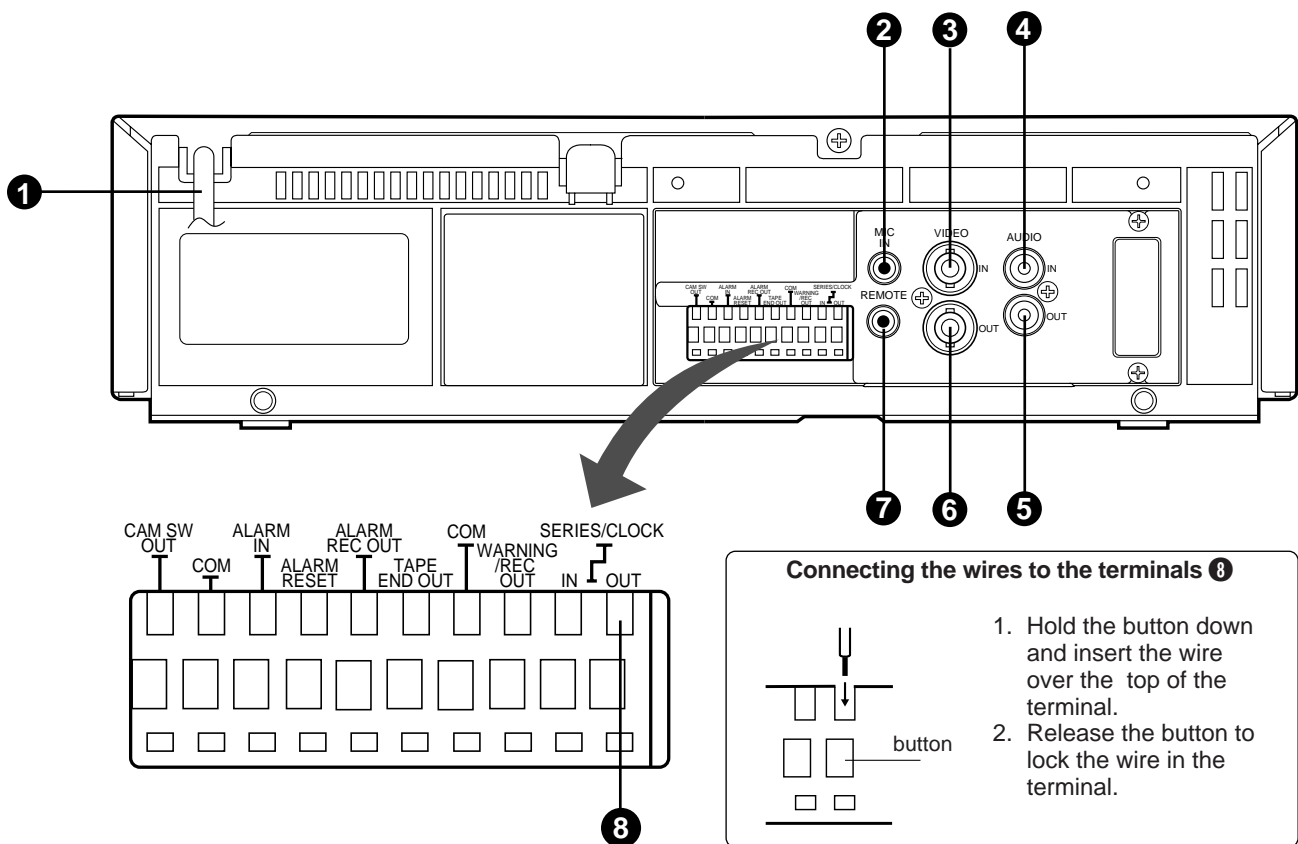

1 Power cable

Connect the power plug to an AC 120 V, 50/60 Hz outlet.

2 [MIC IN] mic input connector

Connect a microphone with 3.6-mm dia. plug. When signals are input from both the microphone connector and the audio input connector, audio signals are mixed and recorded.

3 [VIDEO IN] video input connector (BNC)

Receives composite video signals from a connected camera or other video source.

4 [AUDIO IN] audio input connector (RCA)

Receives audio signals from a connected audio source.

5 [AUDIO OUT] audio output connector (RCA)

Outputs audio signals.

6 [VIDEO OUT] video output connector (BNC)

Outputs composite video signals. Input camera signals (composite video signals) can still be output through this connector even when no power is supplied to the unit (Power-Off Video Throughput function).

7 [REMOTE] remote connector

Connect the optional RM-G30U remote control.

8 [SERIES/CLOCK OUT] series recording signal/clock reset signal output terminal

Outputs the series recording signals or clock reset signals.

Select the output signal with the <TERMINAL SEL 1> menu switch.

• Series recording signal output

- When the <TERMINAL SEL 1> menu switch is set to "SERIES", the series recording signal is output.
- Connect to the other VCR series recording signal input terminal. When the tape being recorded in this unit ends, a signal is output from this terminal to the connected VCR.
- Select the signal output timing with the <REC REMAIN> menu switch (tape end, or 3 minutes or 6 minutes before the tape ends during 6H mode).

• Clock reset signal output

- When the <TERMINAL SEL 1> menu switch is set to "C.ADJ", the clock reset signal is output when the internal clock is at AM0:00 and PM0:00. When connected to the [CLOCK IN] terminal of another SR-9168U, this unit's time can be synchronized with the time on the other VCR if the time difference is within ± 30 seconds.

2 CONTROLS AND CONNECTORS

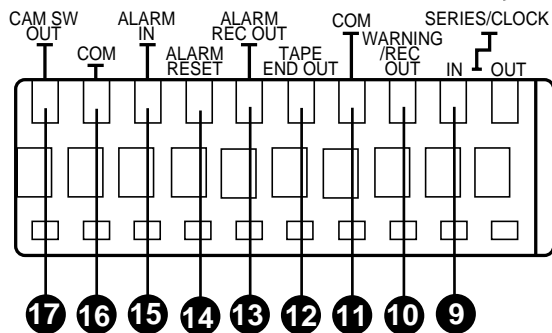
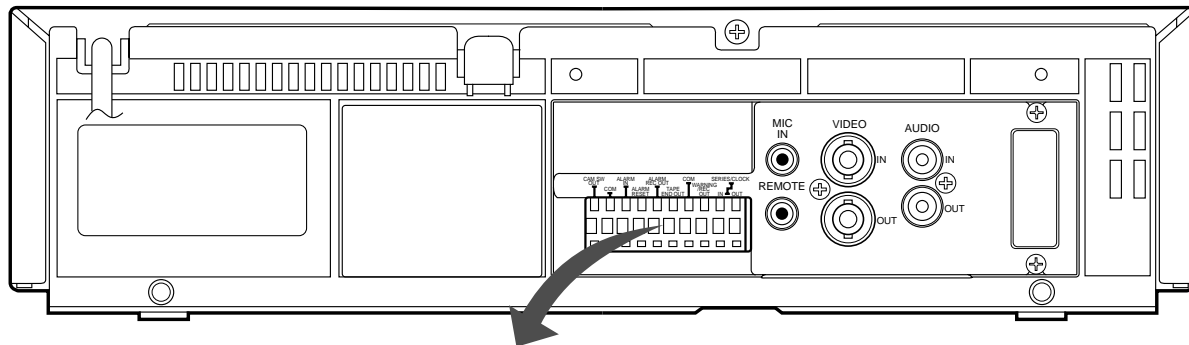

Connecting the wires to the terminals 9 to 17

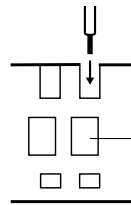

1. Hold the button down and insert the wire over the top of the terminal.
2. Release the button to lock the wire in the terminal.

9 [SERIES/CLOCK IN] series recording signal/clock reset signal input terminal

Input the series recording signals, VCR activation signals from the external control equipment or clock reset signals.

Select the input signal with the <TERMINAL SEL 1> menu switch.

• Series recording signal input

When the <TERMINAL SEL 1> menu switch is set to "SERIES", the series recording signal is input.

- Connect to the other VCR series recording signal output terminal.
- When a series recording signal is received from the other VCR, recording starts automatically.
- **VCR activation signal input**
- When the <TERMINAL SEL 1> menu switch is set to "EXT", recording start and stop can be controlled with external signal input.
- Connect to an external control device.

When a VCR activation signal (ground input) is received, recording starts automatically and continues for as long as the VCR activation signals are input.

• Clock reset signal input

When the <TERMINAL SEL 1> menu switch is set to "C.ADJ", the clock reset signal from the master clock can be received.

- Inputting the clock reset signal synchronizes the time with the master clock time if the time difference is within ± 30 seconds. If the difference exceeds 30 seconds, the time will not be adjusted correctly.

10 [WARNING/REC OUT] warning signal/rec signal output terminal

Outputs a warning signal or recording mode signal. The type of output signal can be selected with the <TERMINAL SEL 2> menu switch.

• Warning signal output

When the <TERMINAL SEL 2> menu switch is set to "WARNING", a warning signal (+12 V) is output if an abnormality occurs in tape transport or mechanism operation.

• Recording mode signal output

When the <TERMINAL SEL 2> menu switch is set to REC and the unit is in the Record mode, the recording mode signal (+12 V) is output.

11 [COM] common ground terminal

Connect to the ground terminal of a connected unit.

12 [TAPE END OUT] tape end signal output terminal

Outputs a Tape End signal when the tape ends during recording.

- Outputs a +12 V signal during recording, playback, FF and rewind. When the tape ends during recording, a 0 V (GND level) signal is output.
- When the tape ends during auto repeat recording, signals are output for about 2 seconds.
- Connect an external alarm lamp or buzzer via an external interface.
- To cancel the output, press the EJECT button, PLAY button, FF button or REW button.

The timing of the tape end signal output during recording can be selected with the <REC REMAIN> menu switch (at tape end, or 3 minutes or 6 minutes before the tape ends during 6H mode).

13 [ALARM REC OUT] alarm recording mode signal output terminal

Outputs +12 V signals during alarm recording.

14 [ALARM RESET] alarm signal reset input terminal

Receives signals to cancel alarm recording.

- Alarm input data is not reset.

15 [ALARM IN] alarm signal input terminal

Receives signals to start alarm or sensor recording.

16 [COM] common ground terminal

Connect to the ground terminal of a connected unit.

17 [CAM SW OUT] camera switching signal output terminal

When a sequential switcher is connected, this terminal outputs camera switching timing control signals. For details, refer to page 52.

3 CONNECTIONS

3-1 Connecting to a Camera

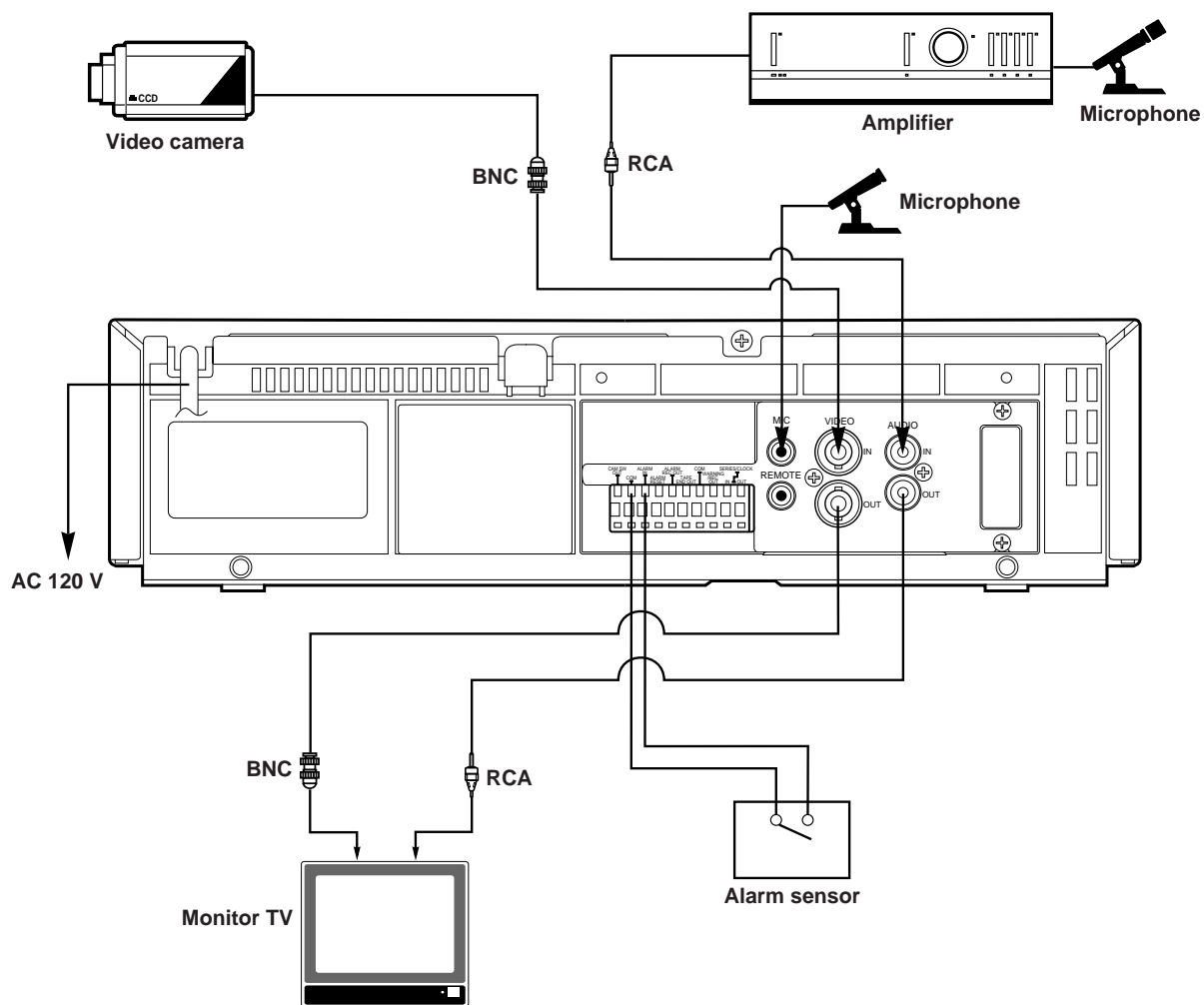

- 1 Connect the monitor's video/audio input connectors to the SR-9168U's video/audio output connectors.
- 2 Connect the video camera's video output connector to the SR-9168U's video input connector.
- 3 Input audio signals to the audio input connectors via an amplifier.
- 4 When connecting an alarm sensor, connect it to the SR-9168U's alarm input terminal.
- 5 When the connection is complete, connect the power plug to an AC 120 V, 50/60 Hz outlet.

3 CONNECTIONS

3-2 Connecting a System Using a Sequential Switcher

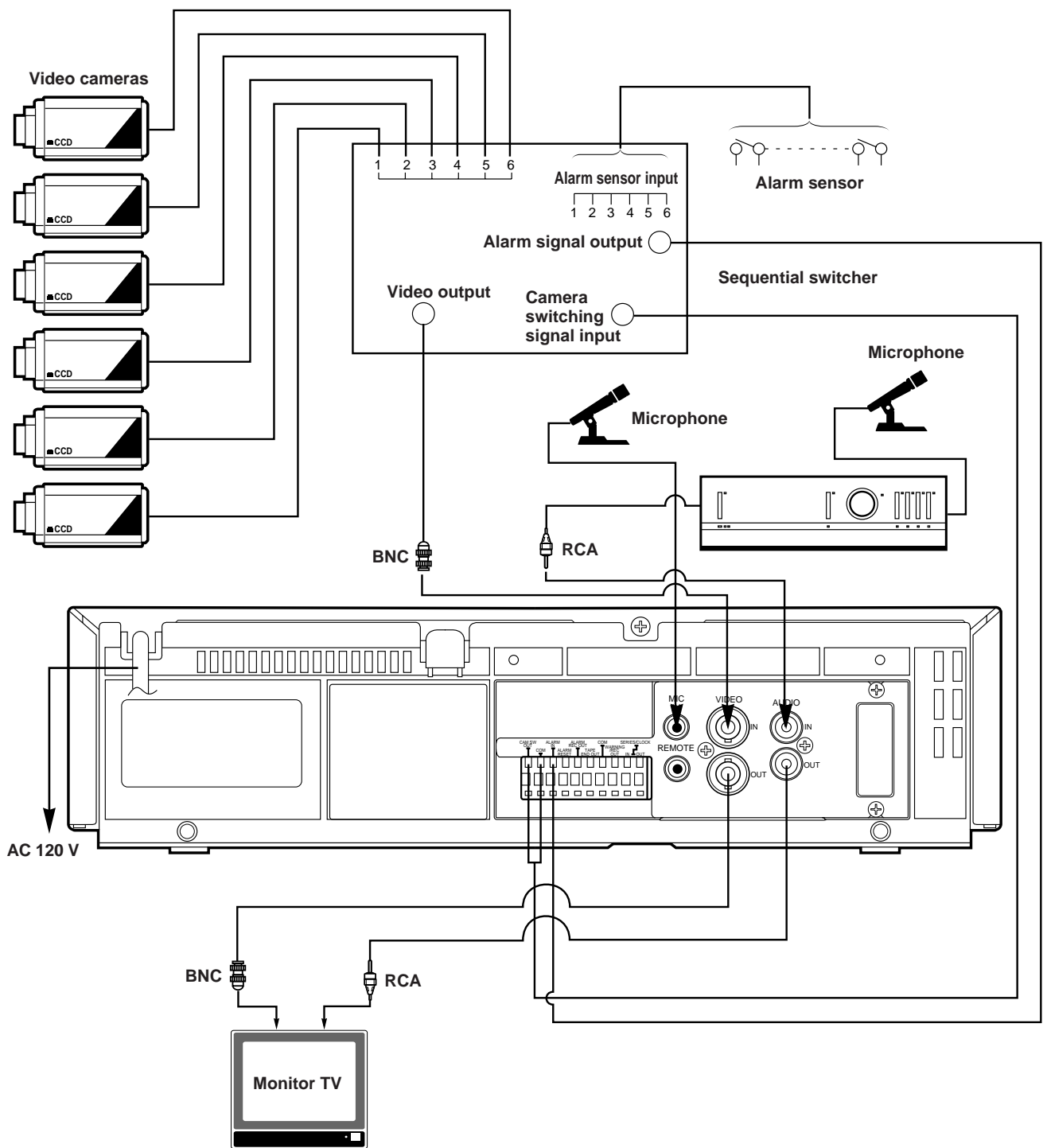

- 1 Connect video cameras and alarm sensor to a sequential switcher (frame switcher).
- 2 Connect the sequential switcher's (frame switcher) alarm signal output, camera switching signal input and video output to the SR-9168U's.
- 3 Connect the monitor's video/audio input connectors to the SR-9168U's video/audio output connectors.
- 4 When the connection is complete, connect the power plug to an AC 120 V, 50/60 Hz outlet.
- 5 Synchro should be applied to all connected video cameras.

3 CONNECTIONS

3-3 Connecting the Rear Panel Input/Output Terminal Connections

[CAM SW OUT] camera switching signal output terminal

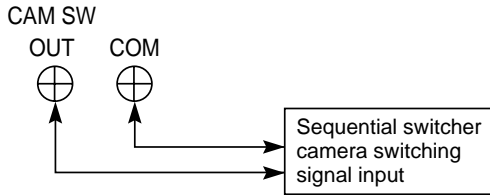

[ALARM IN] alarm signal input terminal

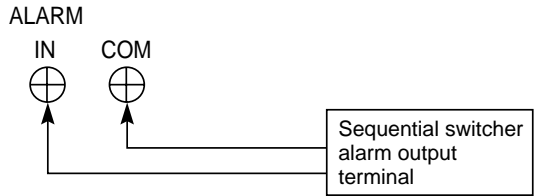

[ALARM RESET] alarm reset terminal

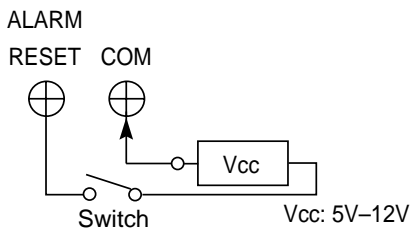

[ALARM REC OUT] alarm recording mode signal output terminal

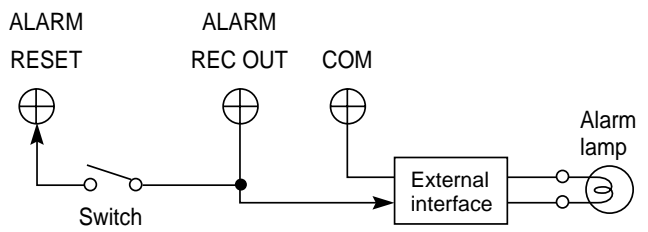

[TAPE END OUT] tape end output terminal

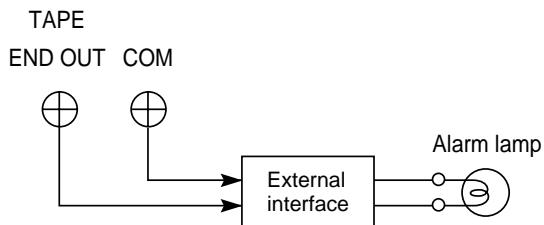

[WARNING/REC OUT] warning signal/recording mode signal output terminal

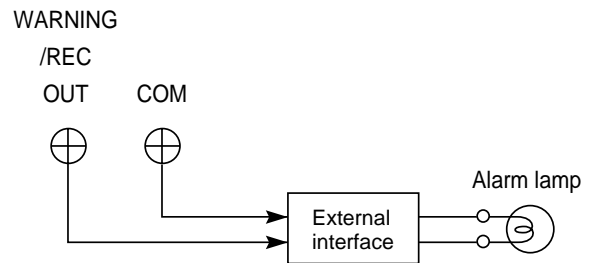

[CLOCK IN/OUT] clock reset terminal

■ When setting the clock to the first VCR's clock

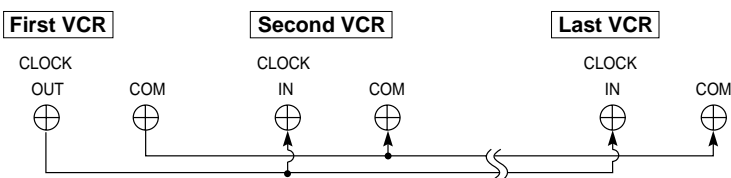

■ When setting the clock to the external master clock

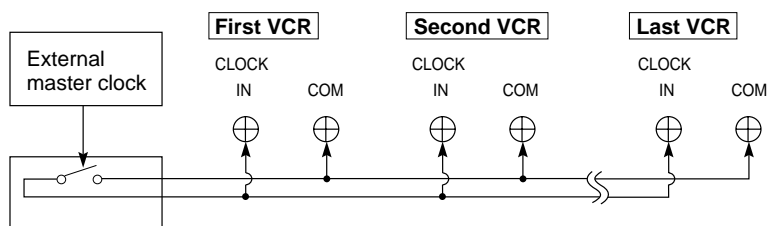

External interface example

Example: Lamp lights with HIGH signal

■ Use appropriately rated devices.

4 MONITOR ON-SCREEN DISPLAY

Status information and other data including date/time, alarm input data, power loss (power failure) data and total operation hours can be displayed on a connected monitor. Function settings can be switched via the on-screen function menu switches and menu screens are also provided for timer recording program setting and date/time setting.

- Normally, the time/date data is shown on screen.
- Additional data displays and menu screens can be displayed by pressing the [MENU] button. This calls up the main menu screen where you can select items as desired.

4-1 On-Screen Display in the Time/Date and Record Modes

Time/date and recording mode data is recorded and displayed on screen.

In the Stop, Record and Record Pause modes, data is superimposed on the input video signals.

- The on-screen display can be switched ON/OFF using the <POSITION> switch in the function menu's ON SCREEN MODE setting screen. You can also change the on-screen display position using this switch.

Menu switch
<POSITION> setting

• "L-UP"

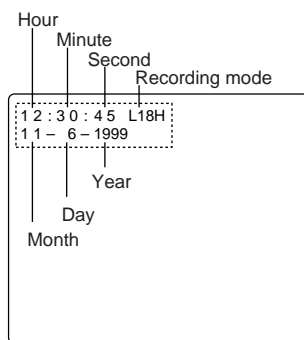

• "R-UP"

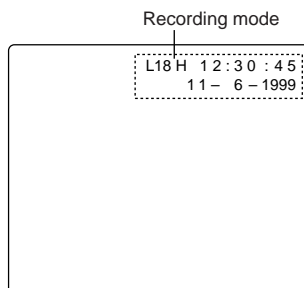

• "R-BOTTOM"

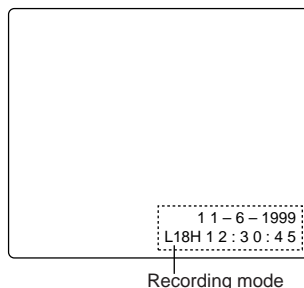

• "L-BOTTOM"

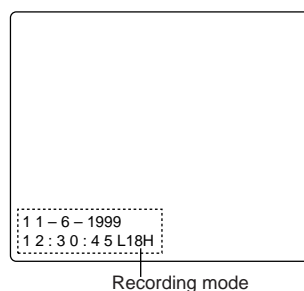

Display

- Connect the VCR's video output connector to the monitor's video input connector.
- 1 Turn the power on (monitor and VCR) and engage the Stop mode.
- 2 • When a video signal is input to the video input connector, time/date, and recording mode are superimposed on the picture.
 - If there is no signal input, display data is superimposed on a black background.

* If the date and time have not been set, correct date and time indications are not available.

- If no on-screen data is displayed, set the <POSITION> menu switch in the function menu's ON SCREEN MODE setting screen to the desired position (except "OFF").

Changing the display position

You can select the position on screen where data is displayed with the <POSITION> menu switch in the ON SCREEN MODE setting screen. Data can be displayed in any one of the four corners of the screen.

Setting of the menu switch <POSITION>

- L-UP : Left top (factory setting)
- R-UP : Right top
- R-BOTTOM : Right bottom
- L-BOTTOM : Left bottom
- OFF : Display is off. No indications are shown.

- For "Function menu switch setting", refer to page 17.

- In the Record mode, on-screen time/date and recording mode data is recorded together with video signals. If you do not want to record on-screen data, set the <POSITION> menu switch to "OFF".
- In the Play mode, on-screen data recorded on the tape is displayed.

4 MONITOR ON-SCREEN DISPLAY

4-2 Main Menu Display

You can display date and time data recorded when an alarm input or power failure occurs, as well as the hour meter (drum rotating time) by selecting the desired item in the main menu.

The timer recording program setting screen, function menu switch setting screen, and date/time setting screen can also be displayed by selecting the desired item in the main menu.

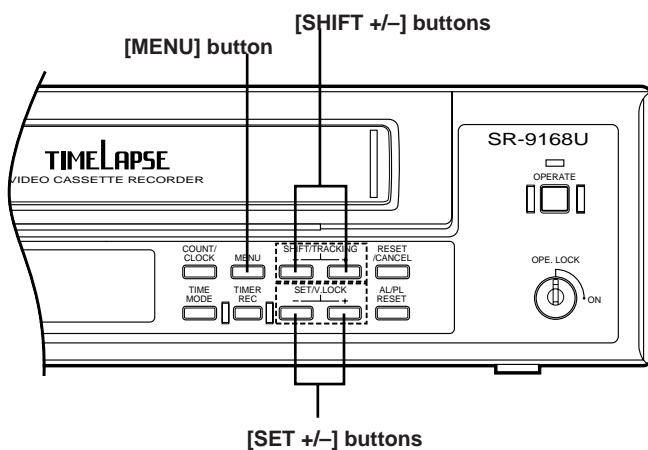

Main menu screen

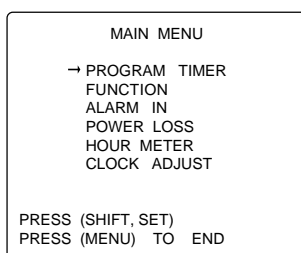

- **PROGRAM TIMER:**
Displays the program setting screen for timer recording.

* Timer programming is not possible if the date and time are not set. In this case, the date/time setting screen will be displayed.

- **FUNCTION:**
Displays the function menu setting screen.
- **ALARM IN:**
Displays the date and time when an alarm signal was input.
- **POWER LOSS**
Displays the date and time when a power failure occurred.
- **HOUR METER:**
Displays the hour meter (drum rotating time).
- **CLOCK ADJUST:**
Displays the date/time setting screen.
* Set the date and time before using this unit.

Operation

- 1 Connect the VCR's video output connector to the monitor's video input connector.
- 1 Turn on the VCR and the monitor. Make sure the Stop mode is engaged.
- 2 Press the [MENU] button.
→ The main menu screen is displayed.
- 3 Press the [SHIFT +/-] button to move the cursor arrow to the item you want to display.
 - Press the [SHIFT +] button to move the cursor arrow down. Press the [SHIFT -] button to move it up.
- 4 Press the [SET +] or [SET -] button to display the selected item.
- 5 To end menu operation and restore the normal screen, press the [MENU] button.

- When the [MENU] button is pressed during playback, the monitor screen display switches from the playback picture to the input video signal (EE picture) and the main menu is shown on the screen. This means that even during playback you can check menu contents. Press the [MENU] button again to restore the playback picture.

4 MONITOR ON-SCREEN DISPLAY

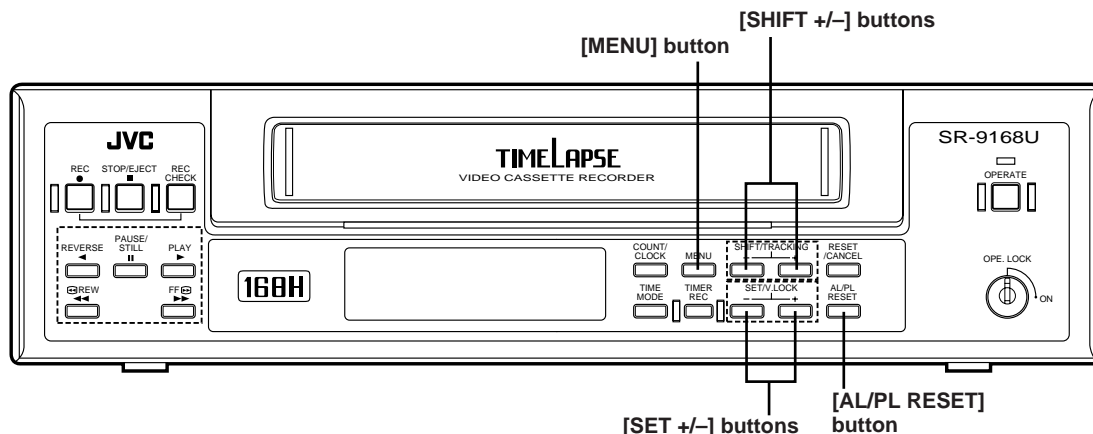

4-3 Alarm Input/Power Loss Data Display

The dates and times of up to nine (9) alarm inputs or power losses (failures) can be displayed.

Alarm input data screen

ALARM IN			
AL-001	20:30	9-	6-99
AL-002	21:44	10-	6-99
AL	---	---	---
AL	---	---	---
AL	---	---	---
AL	---	---	---
AL	---	---	---
AL	---	---	---
AL	---	---	---
AL	---	---	---
PRESS (AL / PL) TO ALL RESET			
PRESS (MENU) TO END			

Hour Minute Day Year

← First alarm
← Second alarm

Power loss (failure) data screen

POWER LOSS			
PL-001	21:30	9-	6-99
PL-002	17:44	10-	7-99
PL	---	---	---
PL	---	---	---
PL	---	---	---
PL	---	---	---
PL	---	---	---
PL	---	---	---
PL	---	---	---
PL	---	---	---
PRESS (AL / PL) TO ALL RESET			
PRESS (MENU) TO END			

Hour Minute Day Year

← First power failure
← Second power failure

- 1 Turn on the VCR and monitor. Make sure the Stop mode is engaged.
- 2 Press the [MENU] button to display the main menu.
- 3 Press the [SHIFT +] or [SHIFT -] button to select ALARM IN or POWER LOSS.
 - To display alarm input data, select ALARM IN. To display power failure data, select POWER LOSS.
- 4 Press the [SET +] or [SET -] button to display the selected data (alarm input or power loss).
 - When 10 or more alarm input or power loss data items have been stored, subsequent data will replace earlier items, beginning from the second item.
- 5 Press the [MENU] button twice to end menu operation and restore the normal screen.

Resetting alarm input/power loss (failure) data

When the "AL" (alarm) display is off and the VCR is in the normal screen mode, press the [AL/PL RESET] button to reset the alarm input and power loss data stored in memory.

4-4 Hour Meter Display

Drum rotating time is displayed in the form of an hour meter. Use this data to schedule maintenance.

Hour meter screen

HOUR METER	
DRUM ON	02345H
PRESS (MENU) TO END	

Drum rotating time

Operation

- 1 Turn on the VCR and monitor. Make sure the Stop mode is engaged.
- 2 Press the [MENU] button to display the main menu.
- 3 Press the [SHIFT +] or [SHIFT -] button to select HOUR METER.
- 4 Press the [SET +] or [SET -] button to display the hour meter (drum rotating time).
- 5 Press the [MENU] button twice to end menu operation and restore the normal screen.

5 SETTING OF THE FUNCTION MENU SWITCHES

You can customize the VCR's functions to suit the requirements of your application using on-screen menu's function switches.

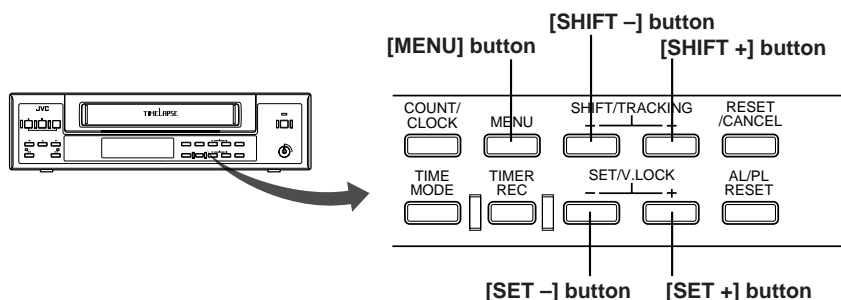

- Menu function switches are available on four setting screens: ON SCREEN MODE, VTR MODE 1, VTR MODE 2 and ALARM/SENSOR REC mode. (When the optional SA-K97U RS-232C interface board is installed, the RS-232C PARAMETER setting screen is also available.)

5-1 Function Menu Switch Setting

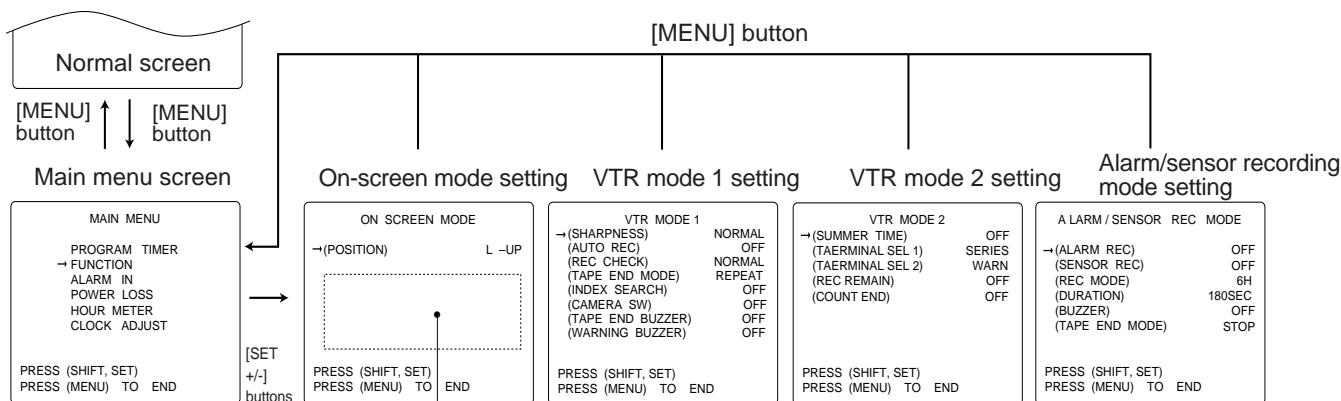

- When the optional SA-K97U RS-232C interface board is installed, the RS-232C PARAMETER setting screen is also available.
- Select an item with the [SHIFT +/-] buttons.
- Enter the selected values with the [SET +/-] buttons.

Preparation

- Connect the VCR's video output connector to the monitor's video input connector.
 - Turn on the VCR and the monitor. Make sure the Stop mode is engaged.
- 1 Press the [MENU] button to display the main menu.
 - 2 Press the [SHIFT +] or [SHIFT -] button to select FUNCTION.
 - 3 Press the [SET +] or [SET -] button.
 - The ON SCREEN MODE setting screen is displayed.
 - Only one menu switch is available in the ON SCREEN MODE setting screen. This switch (<POSITION>) allows you to select the screen position of the on-screen display and to switch it ON/OFF.
 - 4 Press the [SET +] or [SET -] button to enter the selected position.
 - 5 To display another setting screen, press the [SHIFT +/-] button.
 - Press the [SHIFT +] button to display the VTR mode 1 setting screen.
 - Press the [SHIFT -] button to display the alarm/sensor recording mode setting screen.

- 6 The VTR mode 1, VTR mode 2 and alarm/sensor recording mode setting screens include several menu switches.
 - Press the [SHIFT +] or [SHIFT -] button to select the item you want to set.

- When the cursor arrow reaches the last item (bottom of the screen) pressing the [SHIFT +] button advances the display to the next menu switch setting screen. e.g.: (WARNING BUZZER) → (SUMMER TIME)
- When the cursor arrow is at the first item (top of the screen), pressing the [SHIFT -] button will change the display to the previous menu switch setting screen. e.g.: (SHARPNESS) → (POSITION)

- 7 Press the [SET +] or [SET -] button to enter the selected value.
 - To set more than one menu switch, repeat steps 6 and 7.
- 8 End menu switch setting. Press the [MENU] button twice.
 - The normal screen is restored.

- Set values are stored in the VCR's memory. This data is retained even when the power is turned off.

5 SETTING OF THE FUNCTION MENU SWITCHES

5-2 Contents of the Function Menu Switches

Three function menu switch setting screens are available.

[]: Factory setting

Screens	Items	Set values	Function
On-screen mode setting	POSITION	[L-UP] R-UP R-BOTTOM L-BOTTOM OFF	Sets the on-screen position of time/date and recording mode data. If no on-screen display is required, use this menu switch to turn it off. L-UP : Display is shown in the top left corner of the screen. R-UP : Display is shown in the top right corner of the screen. R-BOTTOM : Display is shown in the bottom right corner of the screen. L-BOTTOM : Display is shown in the bottom left corner of the screen. OFF : The on-screen display is not shown.
VTR mode 1 setting	SHARPNESS	[NORMAL] SHARP	Selects the picture quality in the Play mode. NORMAL : Normal picture quality. SHARP : Picture contours are emphasized.
	AUTO REC	[OFF] ON	Enables or disables automatic external timer recording or automatic restart of recording after a power failure. OFF : External timer recording or automatic recording after power failure is disabled. ON : Recording starts automatically when power is turned on.
	REC CHECK	[MANUAL] AUTO	Sets whether or not Recording Check is automatically performed at the beginning of a tape in the Repeat Recording mode. Also sets what action is taken if picture quality is found to be defective when Recording Check is activated with the [REC CHECK] button. MANUAL: <ul style="list-style-type: none"> If picture quality is found to be defective when Recording Check is activated with the [REC CHECK] button, head cleaning is performed once and recording resumes. The error indication "E-09" is shown on the display for 10 seconds. Automatic Recording Check is not performed at the beginning of a tape set to record repeatedly. AUTO: <ul style="list-style-type: none"> If picture quality is found to be defective when Recording Check is activated with the [REC CHECK] button, head cleaning is performed and recording resumes for several seconds, then the recording is automatically checked again. If the picture quality is still defective, head cleaning is performed again and the error indication "E-09" is shown on the display. The error indication remains displayed while recording continues. Automatic Recording Check is performed at the beginning of a tape set to record repeatedly. If the picture quality is defective, Recording Check is performed again. If the picture quality is still defective, head cleaning is performed again and the error indication "E-09" is shown on the display. The error indication remains displayed while recording continues.
	TAPE END MODE	[STOP] REW REPEAT EJECT	Sets the operation mode when the tape ends in the Record mode. (In the Play and FF modes, the tape stops.) STOP : The tape stops. REW : The tape automatically rewinds and enters the Stop mode. REPEAT : In the Record mode, the tape automatically rewinds and then restarts recording (repeat recording). EJECT : The tape is ejected. <div style="border: 1px solid black; padding: 5px; margin-top: 10px;"> <p>The operation mode at tape end during recording, in the case when alarm or sensor recording is executed even once, can be set with the menu switch <TAPE END MODE> on the alarm/sensor recording mode setting screen.</p> </div>

5 SETTING OF THE FUNCTION MENU SWITCHES

5-2 Contents of the Function Menu Switches

[]: Factory setting

Screens	Items	Set values	Function																		
VTR mode 1 setting	INDEX SEARCH	[OFF] ON	Enables or disables the Index Search function. OFF : The index search function is disabled. ON : When an alarm-recorded tape is put in the FF or REW Shuttle Search mode, the VCR searches for the nearest recorded index code (VISS signal) and engages playback at the indexed position. When an alarm-recorded tape is fast-forwarded or rewound, the VCR searches for the nearest index code and enters the Stop mode at the indexed position.																		
	CAMERA SW	[OFF] 1 FIELD 1 FRAME	Sets the camera switching interval for output to an external sequential switcher during recording. OFF : No camera switching signal is output. 1 FIELD : Set to this position to switch the camera every 1 field. 1 FRAME : Set to this position to switch cameras every 1 frame.																		
	TAPE END BUZZER	[OFF] ON	Turns the Tape End buzzer on or off. OFF : The buzzer does not sound at tape end. ON : When the tape reaches the position set with the <REC REMAIN> menu function switch during recording (tape end, or 3 minutes or 6 minutes before the tape ends during 6H mode), a buzzer sounds. To stop the buzzer sound, press the [REW] button, [EJECT] button or [POWER] button. When the mode is changed, the buzzer sound stops.																		
	WARNING BUZZER	[OFF] ON	Turns the warning buzzer on or off. OFF : The buzzer does not sound. ON : The buzzer sounds.																		
VTR mode 2 setting	SUMMER TIME	[OFF] ON	Turns summer time compensation on or off. OFF : Clock is not adjusted for summer (daylight saving) time. ON : Clock is adjusted for summer (daylight saving) time.																		
	TERMINAL SEL 1	[SERIES] EXT C.ADJ	Select the signal to be input or output to the [SERIES/CLOCK IN-OUT] terminals on the rear panel. SERIES : Set to this position to input or output a series recording signal. EXT : Set to this position to start or stop the recording with the VCR activation signal input from an external control device. C.ADJ : Set to this position to input or output a clock reset signal.																		
	TERMINAL SEL 2	[WARN.] REC	Select the signal output from the rear panel's [WARNING/REC OUT] terminal. WARN. : Set to this position to output a warning signal. The warning signal is output if an abnormality occurs in tape transport or mechanism operation. REC : Set to this position to output a recording mode signal (+12 V) in the Record mode.																		
	REC REMAIN	[OFF] 180S 360S	Sets the timing to process tape end before the actual tape end. This menu switch setting is effective in the 6H to L30H Record modes. For the 48H to 240H modes, set with <COUNT END>. The following operations are executed at the timing set with this menu switch. <ul style="list-style-type: none"> The tape end signal is output from the rear panel's [TAPE END] terminal. The series recording signal is output from the rear panel's [CLOCK/SERIES OUT] terminal (with the TERMINAL SEL 1> function menu switch set to "SERIES"). The tape end buzzer sounds (with the <TAPE END BUZZER> function menu switch set to "ON"). "End" is shown on the counter display. The set values (180S/360S) are for the 6H mode. The relation between the recording mode and the recording time is shown below. <table border="1" style="margin-left: auto; margin-right: auto;"> <thead> <tr> <th rowspan="2">Setting</th> <th colspan="3">Record modes</th> </tr> <tr> <th>6H</th> <th>L18H</th> <th>L30H</th> </tr> </thead> <tbody> <tr> <td>OFF</td> <td>Tape end</td> <td>Tape end</td> <td>Tape end</td> </tr> <tr> <td>180S</td> <td>3 minutes</td> <td>9 minutes</td> <td>15 minutes</td> </tr> <tr> <td>360S</td> <td>6 minutes</td> <td>18 minutes</td> <td>30 minutes</td> </tr> </tbody> </table> <p>These values should be used as a reference only. Actual values may differ depending on the tape used.</p>	Setting	Record modes			6H	L18H	L30H	OFF	Tape end	Tape end	Tape end	180S	3 minutes	9 minutes	15 minutes	360S	6 minutes	18 minutes
Setting	Record modes																				
	6H	L18H	L30H																		
OFF	Tape end	Tape end	Tape end																		
180S	3 minutes	9 minutes	15 minutes																		
360S	6 minutes	18 minutes	30 minutes																		

5 SETTING OF THE FUNCTION MENU SWITCHES

5-2 Contents of the Function Menu Switches

[]: Factory setting

Screens	Items	Set values	Function
VTR mode 2 setting	COUNT END	[OFF] 500 1000 ⋮ 9500	<p>Sets the timing to process tape end at a specified counter value rather than at the actual tape end. This menu switch setting is effective in the 48H to 240H Record modes. For the 6H to L30H modes, set with <REC REMAIN>. The following operations are executed at the timing set with this menu switch.</p> <ul style="list-style-type: none"> The tape end signal is output from the rear panel's [TAPE END] terminal. The series recording signal is output from the rear panel's [CLOCK/SERIES OUT] terminal (with the TERMINAL SEL 1> function menu switch set to "SERIES"). The tape end buzzer sounds (with the <TAPE END BUZZER> function menu switch set to "ON"). "End" is shown on the counter display. <p>OFF: Executes tape end processing at the actual tape end. 5000 - 9500: Executes tape end processing at the set tape counter value. To determine the set tape counter value according to the tape length, refer to the table on page 53.</p>
Alarm/sensor recording mode setting	ALARM REC	[OFF] ON	<p>Turns the alarm recording function on or off.</p> <p>Alarm recording is enabled only in the Timelapse Record mode. An index code (VISS signal) is also recorded at the start point of alarm recording as an alarm cue signal.</p> <p>OFF : Alarm recording is disabled. ON : This unit enters the specified Record mode, when an alarm signal is input to the rear panel's [ALARM IN] terminal during timelapse recording.</p>
	SENSOR REC	[OFF] ON	<p>Turns the sensor recording function on or off. Sensor recording is enabled in the Stop mode. An index code (VISS signal) is also recorded at the start point of sensor recording.</p> <p>OFF : Sensor recording is disabled. ON : When an alarm signal is input to the rear panel's [ALARM IN] terminal in the Stop mode. This unit automatically starts recording in the specified Record mode.</p>
	REC MODE	[6H] 18H 30H	<p>Selects the recording mode for alarm recording or sensor recording.</p> <p>6H : Recording is executed in the 6H(EP) mode. 18H : Recording is executed in the 18H mode. This value is not selected when the <DURATION> function menu switch is set to "5 sec". 30H : Recording is executed in the 30H mode. This value is not selected when the <DURATION> function menu switch is set to "5 sec" or "15 sec".</p>
	DURATION	5 15 30 60 120 [180] TAPE END MANUAL	<p>Selects the recording duration for alarm recording or sensor recording.</p> <p>5 180 : Alarm or sensor recording is performed for the time specified (5 sec. to 180 sec.).</p> <ul style="list-style-type: none"> 5 sec is not selected when the <RECMODE> function menu switch is set to "18H". 5 or 15 sec is not selected when the <REC MODE> function menu switch is set to "30H". <p>TAPE END: Alarm or sensor recording continues until the tape ends. MANUAL : Alarm or sensor recording continues for as long as alarm signals are input. Set to this position when specifying the alarm recording time with a switcher.</p>
	BUZZER	[OFF] ON	<p>Selects whether or not the alarm buzzer sounds during alarm or sensor recording.</p> <p>OFF : The buzzer does not sound. ON : The buzzer sounds.</p>
	TAPE END MODE	[STOP] REW REPEAT EJECT	<p>Set the operation mode at tape end during recording in the case when alarm or sensor recording is executed even once.</p> <p>STOP : Stops at tape end. REW : Rewinds the tape automatically and stops. REPEAT : Rewinds the tape automatically to the beginning and restarts recording. EJECT : The tape is ejected.</p>
	RS-232C parameter setting	This screen is displayed on the on-screen setting screen only when the (optional) RS-232C board SA-K97U is installed.	
BAUD RATE		1200 2400 4800 [9600]	Select the RS-232C data transfer speed from 1200 bps, 2400 bps, 4800 bps or 9600 bps.

6 PREPARATION

6-1 Cassette Loading/Unloading

Loading

Insert the cassette with its label side facing you.
Gently push the center of the cassette until the machine starts automatic loading.

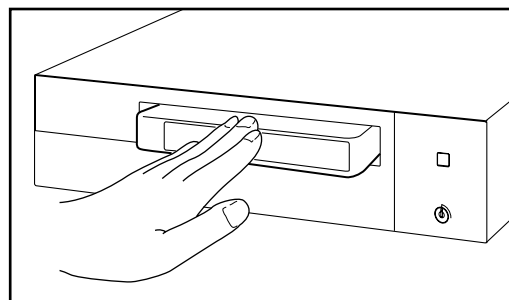
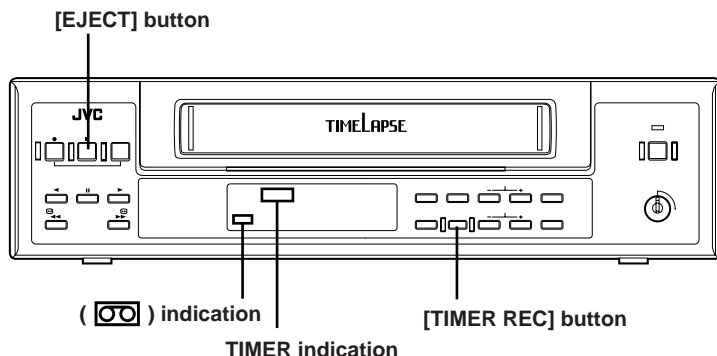

Note:

To avoid damage or injury, do not insert your hand or other foreign objects into the cassette loading slot.

Auto power on

When a cassette is loaded, the power automatically turns on and the ([CASS]) cassette indication appears.

Auto play

When a cassette with no erasure prevention tab is loaded, playback starts automatically.

Unloading

■ **Press the [EJECT] button.**

→ The cassette is ejected.

If the power is not on when the [EJECT] button is pressed, power is automatically switched on and the cassette is ejected. Once the cassette is unloaded, the power turns off again automatically.

If the Timer Recording Standby mode is engaged (TIMER indication is shown on the display), the cassette will not be ejected when the [EJECT] button is pressed.

To unload the cassette, press the [TIMER REC] button to release the Timer Recording Standby mode, then press the [EJECT] button.

6-2 Date and Time Setting

The time/date generator and timer recording will not function if the date and time are not set.
The time/date setting can be enabled on the CLOCK ADJUST menu screen or the front panel display.

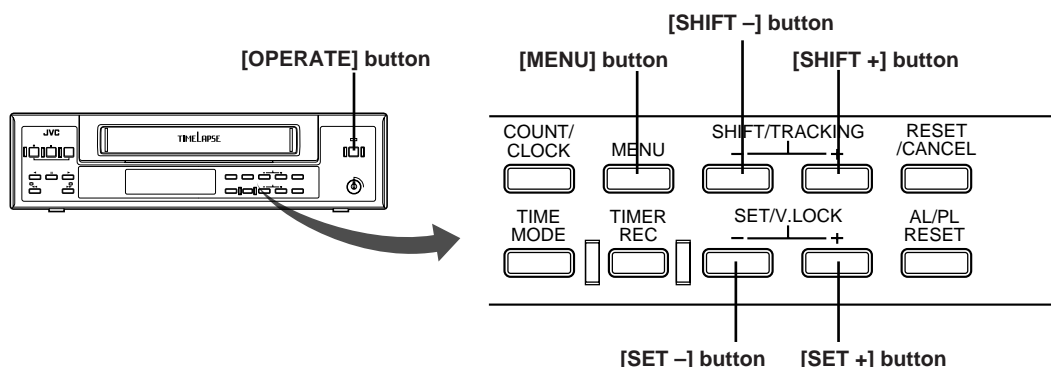

- Time-keeping continues even when the power cable is unplugged from the AC outlet or a power failure occurs.
- If the power cable has been unplugged for a long time of period, check the current time before using the VCR. (Time shift may occur under certain operating or environmental conditions.)

6 PREPARATION

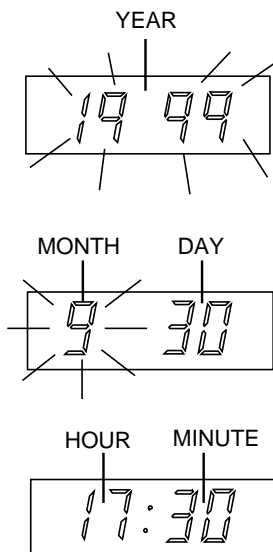
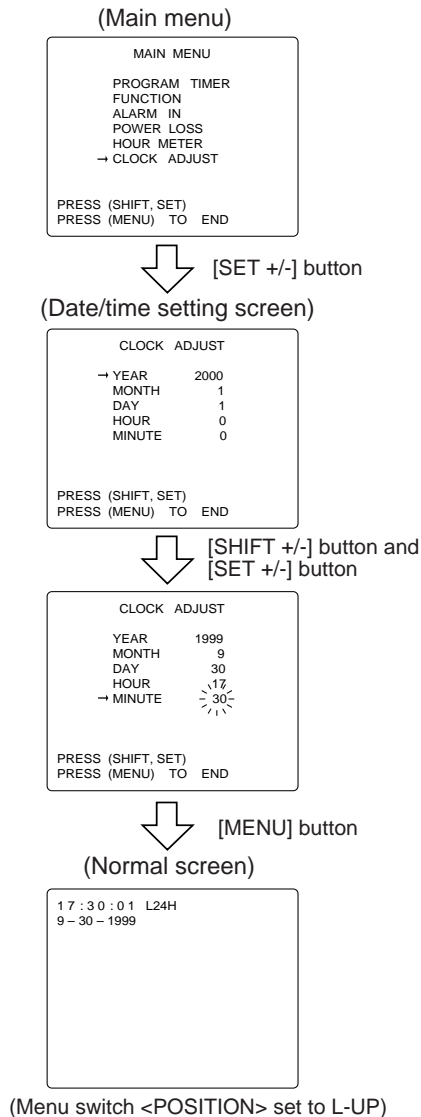

Time indication on the VCR's display

- When the power is turned off, the time is displayed. When the power is turned on, set the time display mode with the [COUNT/CLOCK] button to display the current time.
- The first time you turn on the power, the time display shows a blinking "0:00:00".
- When the built-in backup battery capacity is low, the error indication E-10 appears on the display. Contact your local JVC dealer to replace the built-in battery.

Set the date and time using the CLOCK ADJUST menu screen.

- 1 Turn on this unit and the monitor and engage the Stop mode.
 - 2 Press the [MENU] button to display the main menu screen.
 - 3 Press the [SHIFT +] or [SHIFT -] button to select <CLOCK ADJUST>. (Set the cursor arrow to <CLOCK ADJUST>.)
 - 4 Press the [SET +] or [SET -] button to display the CLOCK ADJUST screen on the monitor.
 - 5 Select the item to be set.
 - Press the [SHIFT +] or [SHIFT -] button to select the item. → The selected item will blink.
 - 6 Enter the value for the selected item with the [SET +/-] button.
 - Press the [SET +] button to increase the number.
 - Press the [SET -] button to decrease the number.
- The setting range for the year is from 1997 to 2096.
 - This VCR uses the 24-hour clock.
 - If an invalid date is set, it is automatically corrected. (e.g.) 1999-2-29 → 1999-2-28
- 7 End date and time setting.
 - Press the [MENU] button twice. → The normal display is restored and the set date and time are shown on screen. The time count starts from 00 seconds.

Note:

- If you press the [OPERATE] button after setting the date and time without first pressing the [MENU] button, the set date and time are canceled.

Set the date and time on the front panel display

- 1 Turn the power on.
- 2 Press the [COUNT/CLOCK] button for at least 2 seconds.
 - The "year" indication blinks in the display.
- 3 Enter the value for the year with the [SET+] or [SET-] button.
- 4 Press the [SHIFT+] button: the "month" indication blinks.
 - Press the [SHIFT+] or [SHIFT-] button to move the blinking section.
 - Enter the value for the blinking section with the [SET+] or [SET-] button.
- 5 Set the "month", "day", "hour" and "minute" with the [SHIFT +/-] and [SET +/-] buttons.
- 6 When you have finished setting, press the [COUNT/CLOCK] button.
 - The display returns to the clock display mode and the time count starts from 00 seconds.

6 PREPARATION

6-3 Summer Time Compensation

Set whether or not the Summer Time mode is engaged with the <SUMMER TIME> function menu switch on the VTR mode 2 setting screen.

When the <SUMMER TIME> switch is set to "ON", the currently set time is advanced one hour.

- When setting the time, make sure the <SUMMER TIME> switch is set to "OFF".
- When the unit is shipped, this switch is set to "OFF".
- Clock setting is not possible during timer recording.

During daylight savings time

- 1 Set the time with one-hour delay.
- 2 After setting the time, set the <SUMMER TIME> switch to "ON".
 - The set time advances one hour.
- 3 At the end of the daylight savings time season, set the <SUMMER TIME> switch to OFF.
 - The standard time instead of "Summer Time" is displayed.

Standard time

- 1 Set the clock to the actual time.
- 2 When daylight savings starts, set the <SUMMER TIME> menu switch to "ON".
 - The time advances one hour on the display

6-4 Selection of Record/Play Mode

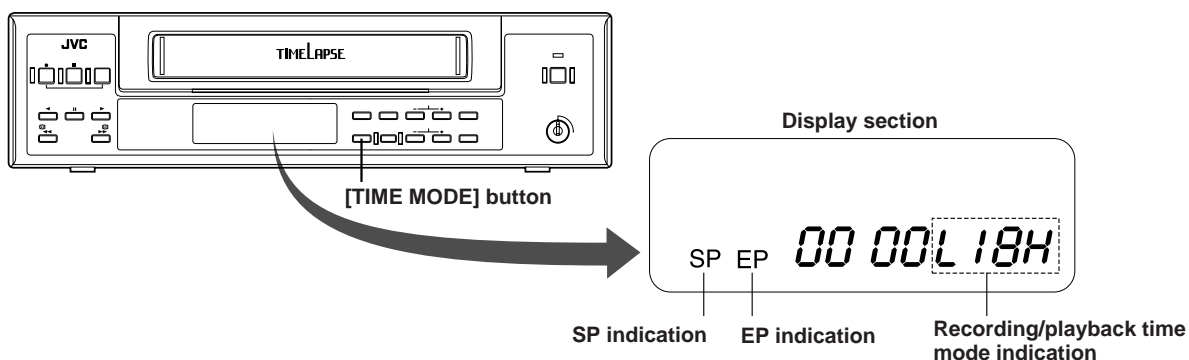

- 1 Press the [OPERATE] button to turn the operating mode on. The [OPERATE] indicator lights.
- 2 Select the recording/playback time mode with the [TIME MODE] button. Refer to the table below for more information on each mode.
 - Each time the [TIME MODE] button is pressed, the recording/playback mode changes in the following order: 6H (VHS EP mode) → L18H (18-hour Timelapse mode) → L30H → 48H → 72H → 96H → 120H → 168H → 240H → 6H (VHS EP mode) ...
 - The selected recording or playback time mode is shown on the display.
 - The EP indicator lights.

Note:

- When a tape recorded in the VHS Standard Play (SP) mode is played back, the SP indicator lights. Recording in the SP mode is not possible with this unit.

Display indications	Modes	Available recording time (hour)				Recording/playback interval (sec.)	Audio recording
		T-30	T-60	T-90	T-120		
6H	VHS EP	1.5	3	4.5	6	—	Possible
L18H	18-hour Timelapse	6	12	13.5	18	0.05	Possible
L30H	30-hour Timelapse	7.5	15	22.5	30	0.08	Possible
48H	48-hour Timelapse	12	24	36	48	0.15	N/A
72H	72-hour Timelapse	18	36	54	72	0.22	N/A
96H	96-hour Timelapse	24	48	72	96	0.28	N/A
120H	120-hour Timelapse	30	60	90	120	0.35	N/A
168H	168-hour Timelapse	42	84	126	168	0.48	N/A
240H	240-hour Timelapse	60	120	180	240	0.68	N/A

* Recording time varies depending on the type of cassette used.

* For optimum performance and reliability, use a tape with a standard recording time of 120 minutes (T-120) or less.

7 RECORDING

7-1 Preparation

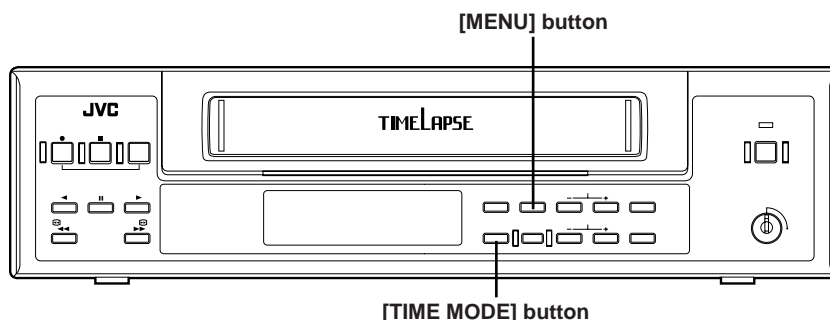

Connection

Make sure the input/output connectors on the rear panel are properly connected. For details, refer to "CONNECTIONS" on page 11 to 13.

Menu switch setting

Set the function menu switches as required.

■ <POSITION> ... Factory setting: L-UP

- Sets the position of the on-screen time/date and recording mode display. Select one of the four corners of the screen. During recording, the on-screen data is recorded in the selected position together with the video signals.
- If on-screen data recording is not required, set this switch to OFF.

■ <AUTO REC> ... Factory setting: OFF

- Set to ON to execute timer recording using a commercially available external timer or to automatically resume recording when power is restored after a power failure.
- For details, refer to "How To Restore Recording After Power Failure" and "External Timer Recording" on page 37.

■ <REC CHECK> ... Factory setting: MANUAL

- Selects between manual and automatic Recording Check operation.
- When set to AUTO, Recording Check is automatically executed at the beginning of a tape set to record repeatedly or when the [REC CHECK] button is pressed. In the Auto mode, Recording Check and head cleaning is automatically repeated up to two times. If the inferior picture quality is detected on both checks, the warning code E-09 is displayed. The warning code remains displayed while recording continues.
 - When set to MANUAL, the Recording Check operation is executed only when the [REC CHECK] button is pressed. If inferior picture quality is detected, head cleaning is performed once and recording resumes. The warning code "E-09" is shown on the display for 10 seconds.

■ <TAPE END MODE> ... Factory setting: STOP

- Selects the mode engaged when the tape ends during recording.
- When set to STOP, the Stop mode is engaged.
 - When set to REW, the tape is rewound to the beginning.
 - When set to REPEAT, the tape is rewound to the beginning and recording re-starts (repeat recording).
 - When set to EJECT, the tape is ejected.

■ <CAMERA SW> ... Factory setting: OFF

- Sets the switching timing for cameras connected to an external sequential switcher.
- To switch cameras after each field or frame, set this menu switch to FIELD or FRAME.

■ <TAPE END BUZZER> ... Factory setting: OFF

- Set to ON to sound the buzzer when the tape ends during recording.

■ <TERMINAL SEL 1> ... Factory setting: SERIES

- Set the rear panel's [SERIES/CLOCK] terminal as required.
- Set to "SERIES" when to use the series recording function.
 - Set to "EXT" when to control recording start/stop from an external device.

■ <TERMINAL SEL 2> ... Factory setting: WARN

- Select the signal output from the rear panel's [WARNING/REC OUT] terminal.
- Set to WARN to output a warning signal.
 - Set to "REC" to output a recording mode signal (+12 V) during recording.

■ <REC REMAIN> ... Factory setting: OFF

- Selects the timing to send the tape end information. Selects the timing for tape end operation in the 6H to L30H Record modes. The timing differs depending on the recording mode. For details, refer to "Contents of the Function Menu Switches" on page 21.

■ <COUNT END> ... Factory setting: OFF

- Selects the timing for tape end operation in the 48H to 240H Record modes. The timing differs depending on the recording mode. For details, refer to "Contents of the Function Menu Switches" on page 22.

■ <ALARM REC> ... Factory setting: OFF

- Set to ON to perform alarm recording. For details, refer to "Alarm Recording" on page 31.

■ <SENSOR REC> ... Factory setting: OFF

- Set to ON to perform sensor recording. For details, refer to "Sensor Recording" on page 33.

Setting on the front panel

- Select the recording time mode with the [TIME MODE] button. For details, refer to "Selection of the Record/Play mode" on page 23.

7 RECORDING

7-2 Recording

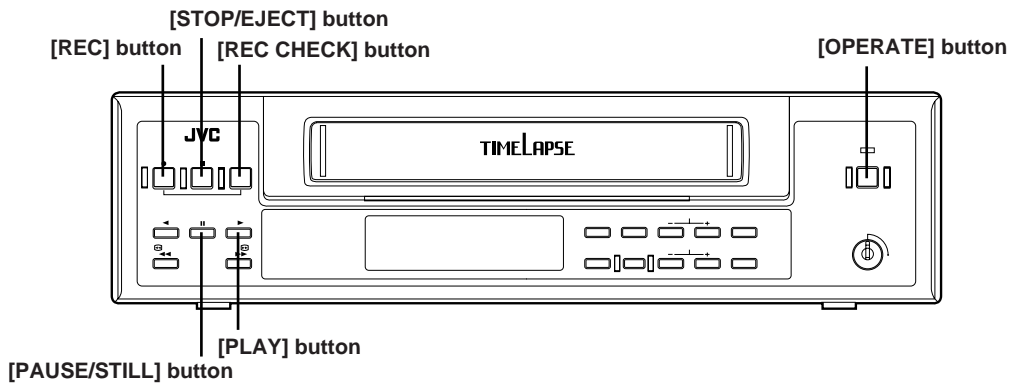

- 1 Press the [OPERATE] button to turn the operating mode on.
→ The [OPERATE] indicator lights.
- 2 Insert a cassette with safety tab in place.
→ The () cassette indication lights on the display.
* If a cassette is loaded when the operating mode is off, the operating mode is switched on automatically (auto operate on function).
- 3 Press the [REC] button to start recording.
→ The recording indicator lights on the display, showing that the Record mode is engaged.

To stop recording temporarily

- 4 Press the [PAUSE/STILL] button.
→ The record-pause indicator is shown on the display and the Pause mode is engaged.

To start recording again

- 5 Press the [PLAY] button.
→ The recording indicator is shown on the display and the Recording mode is engaged.

Note

If the VCR is left in the Record Pause mode for more than 5 seconds, the transition between scenes may be distorted when recording is re-started.

To stop recording

- 6 Press the [STOP/EJECT] button.
→ The tape stops and the Stop mode is engaged.

Recording Check

Record Check in the Timelapse mode should be performed after recording has been executed for more than one minute. If the recording time is too short, Record Check cannot be performed correctly.

- Press the [REC CHECK] button during recording.
→ The tape is played back in reverse for about 5 seconds, then, the Play mode is engaged to check the recording. After playback, the VCR enters the Record mode at the point where the recording was interrupted.
- During Recording Check, the FM level of the signal recorded on the tape is checked in the Play mode to determine whether or not the recording quality is suitable. If the recording quality is judged inferior, subsequent operation depends on the setting of the <REC CHECK> function menu switch.

● When set to MANUAL

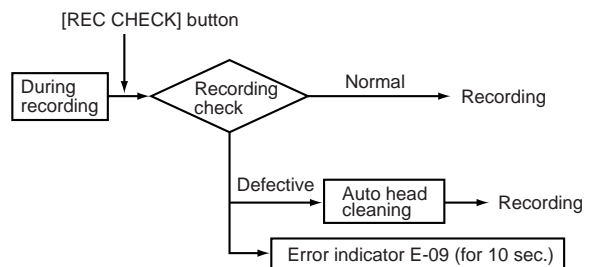

● When set to AUTO

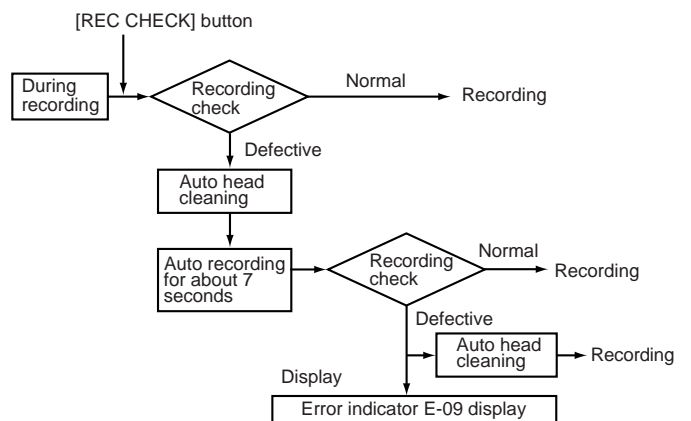

7 RECORDING

7-3 Timer Recording

Two types of timer recording are available: daily timer (by specifying the date) and weekly timer (by specifying the day of the week).

- Daily timer : Set the date to any date within one year of the current date. Up to 8 programs can be set.
- Weekly timer : Set the day of the week. Recording will automatically be performed on that day each week.

You can program the timer using the on-screen menu display.

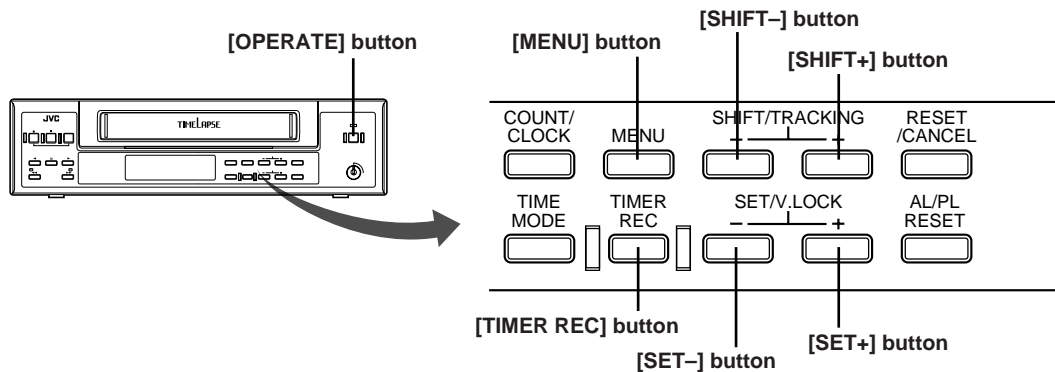

Note:

- Timer programming is not possible if the date and time have not been set.

Preparation

- Make sure all necessary equipment is properly connected to the input/output connectors on the rear panel.
- Check the current time.
- Load a cassette with the safety tab in place. If the power is off, loading the cassette automatically turns the VCR on (auto power on function).

Main menu screen

```

MAIN MENU
→ PROGRAM TIMER
  FUNCTION
  ALARM IN
  POWER LOSS
  HOUR METER
  CLOCK ADJUST

PRESS (SHIFT, SET)
PRESS (MENU) TO END
    
```

Setting the daily timer

Daily timer program setting screen

```

PROGRAM TIMER
→ ( DAILY) START END  MODE
1. ---:--:--:--:--:--H
2. ---:--:--:--:--:--H
3. ---:--:--:--:--:--H
4. ---:--:--:--:--:--H
5. ---:--:--:--:--:--H
6. ---:--:--:--:--:--H
7. ---:--:--:--:--:--H
8. ---:--:--:--:--:--H

PRESS (SHIFT, SET, RESET)
PRESS (MENU) TO END
    
```

- 1 Turn on this unit and the monitor and engage the Stop mode.
 - 2 Press the [MENU] button.
→ The main menu screen is displayed on the monitor.
 - 3 Press the [SHIFT +] or [SHIFT -] button to move the cursor arrow to <PROGRAM TIMER> in the main menu, then press the [SET +] or [SET -] button.
→ The daily timer program setting screen is displayed.
- <DAILY> is shown on the second line of the daily timer program setting screen.

• If the date and time have not been set, the date and time setting screen will be shown. Once the correct date and time have been set, repeat steps 2 and 3.

Weekly timer program setting screen

```

PROGRAM TIMER
→ (WEEKLY) START END  MODE
(MON) ---:--:--:--:--H
(TUE) ---:--:--:--:--H
(WED) ---:--:--:--:--H
(THU) ---:--:--:--:--H
(FRI) ---:--:--:--:--H
(SAT) ---:--:--:--:--H
(SUN) ---:--:--:--:--H

PRESS (SHIFT, SET, RESET)
PRESS (MENU) TO END
    
```

- When the weekly timer program setting screen is displayed, <WEEKLY> is shown on the second line.
 - Press the [SHIFT +] or [SHIFT -] button to set the cursor arrow to <WEEKLY> and press the [SET +/-] or [SET -] button.
→ The cancel program setting screen is displayed.
- When the cancel program setting screen is displayed, <CANCEL> is shown on the second line.
 - Press the [SHIFT +] or [SHIFT -] button to set the cursor arrow to <CANCEL> and press the [SET +/-] or [SET -] button.
→ The daily timer program setting screen is displayed.

7-3 Timer Recording

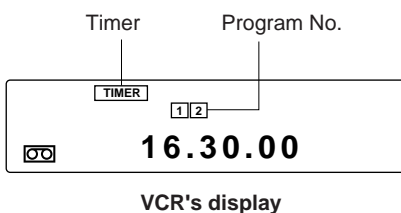
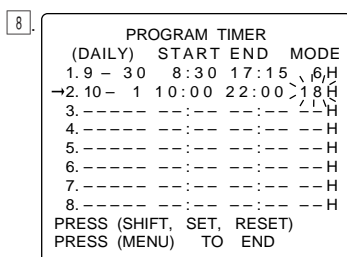
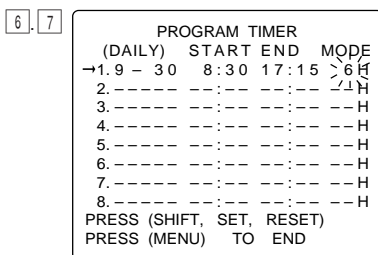
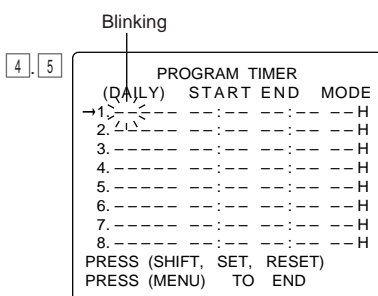
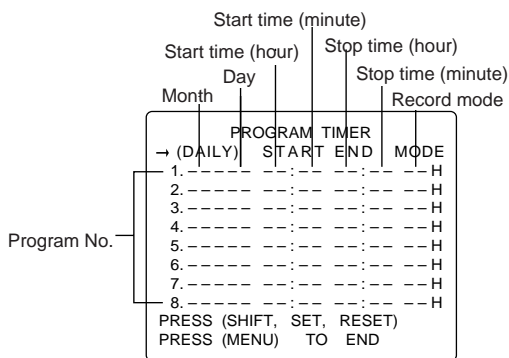

- 4 Select the timer program No.
Press the [SHIFT +] or [SHIFT -] button to move the cursor arrow to the program No. to be set.
 - Press the [SHIFT +] button to move the cursor arrow down and the [SHIFT -] button to move it up.
- 5 Set the selected program No.
Press the [SET +] or [SET -] button.
 - The selected program No. blinks.
 - Press the [SET +] button. The month blinks.
 - Press the [SET -] button. The record mode blinks.
- 6 Set the timer.
 - ① Press the [SHIFT +] or [SHIFT -] button until the item you want to set starts blinking.
 - Press the [SHIFT +] button to shift the blinking to the right.
"Month" → "Day" → "Start time (hour)" → "Start time (minute)" → "Stop time (hour)" → "Stop time (minute)" → "Record mode" → Select the next program No.
 - Press the [SHIFT -] button to move the blinking to the left.
 - ② Press the [SET +] or [SET -] button to set the value for the blinking item.
 - Press the [SET +] button to increase the value and the [SET -] button to decrease it.
 - Set the "Month", "Day", "Start time (hour)", "Start time (minute)", "Stop time (hour)", "Stop time (minute)" and "Record mode" with the [SHIFT +/-] and [SET +/-] buttons.
 - When all values are set, the set program No. is shown on the VCR's display.
- 7 Accessing another program No.
 - Select the "Record mode" (so that it is blinking) and press the [SHIFT +] button. Or, select "Month" (so that it is blinking) and press the [SHIFT -] button.
 - The selected item stops blinking. You may now select another program No.
- 8 To set more than one daily timer program, repeat steps 4 to 7.
 - To program the timer to record once a week indefinitely, move the cursor arrow to the second line <DAILY> and press the [SET +] or [SET -] button. (For details, refer to page 28.)
- 9 To end timer programming, press the [MENU] button twice.
 - The normal screen is restored.
 - Press the [TIMER REC] button.
 - • The [TIMER] indication and the daily timer program numbers light in the VCR's display. Power is switched off automatically and the VCR enters the Timer Record Standby mode.
 - During timer recording, the number of the daily timer program currently being executed blinks.

7-3 Timer Recording

Daily timer program setting screen

```

PROGRAM TIMER
→ ( DAILY ) START END MODE
1. -----:-----:-----H
2. -----:-----:-----H
3. -----:-----:-----H
4. -----:-----:-----H
5. -----:-----:-----H
6. -----:-----:-----H
7. -----:-----:-----H
8. -----:-----:-----H
PRESS (SHIFT, SET, RESET)
PRESS (MENU) TO END
    
```

- Set the cursor arrow to the second line <DAILY> and press the [SET +/-] button.



Weekly timer program setting screen

Start time (minute) | Stop time (hour) | Stop time (minute) | Record mode

```

PROGRAM TIMER
→ (WEEKLY) START END MODE
(MON) -----:-----:-----H
(TUE) -----:-----:-----H
(WED) -----:-----:-----H
(THU) -----:-----:-----H
(FRI) -----:-----:-----H
(SAT) -----:-----:-----H
(SUN) -----:-----:-----H
PRESS (SHIFT, SET, RESET)
PRESS (MENU) TO END
    
```

Days of the week (Monday to Sunday)

Blinking

2, 3

```

PROGRAM TIMER
(WEEKLY) START END MODE
→ (MON) >-----:-----:-----H
(TUE) /-----:-----:-----H
(WED) -----:-----:-----H
(THU) -----:-----:-----H
(FRI) -----:-----:-----H
(SAT) -----:-----:-----H
(SUN) -----:-----:-----H
PRESS (SHIFT, SET, RESET)
PRESS (MENU) TO END
    
```

4, 5

```

PROGRAM TIMER
(WEEKLY) START END MODE
→ (MON) 8:30 19:30 >6H
(TUE) /-----:-----:-----H
(WED) -----:-----:-----H
(THU) -----:-----:-----H
(FRI) -----:-----:-----H
(SAT) -----:-----:-----H
(SUN) -----:-----:-----H
PRESS (SHIFT, SET, RESET)
PRESS (MENU) TO END
    
```

6

```

PROGRAM TIMER
(WEEKLY) START END MODE
(MON) 8:30 19:30 6H
(TUE) 8:30 19:30 6H
(WED) 8:30 17:30 18H
(THU) 8:30 19:30 30H
(FRI) 8:30 22:30 18H
→ (SAT) 10:00 22:00 18H
(SUN) -----:-----:-----H
PRESS (SHIFT, SET, RESET)
PRESS (MENU) TO END
    
```

Timer

```

[TIMER]
16.30.00
VCR's display
    
```

Setting the weekly timer

You can program the VCR to record on a specified day each week.

- Using the same procedure as in daily timer program setting, select <PROGRAM TIMER> in the main menu to display the timer program setting screen on the monitor. (Refer to steps 1 to 3 in daily timer programming.)

- When the timer program setting screen is displayed, the daily timer program setting screen is shown first.

- 1 Display the weekly timer program setting screen. (<WEEKLY> is shown on the second line.)
 - Press the [SHIFT +] or [SHIFT -] button to move the cursor arrow to <DAILY> and press the [SET +] or [SET -] button.
 - The weekly timer program setting screen is shown.
- 2 Select the day of the week you want to record on. Press the [SHIFT +] or [SHIFT -] button to set the cursor arrow to the day of the week to be set.
 - Press the [SHIFT +] button to move the cursor arrow down and the [SHIFT -] button to move it up.
- 3 Set the selected day of the week. Press the [SET +] or [SET -] button.
 - The selected day of the week blinks.
 - Press the [SET +] button. The start time (hour) blinks.
 - Press the [SET -] button. The record mode blinks.
- 4 Set the timer.
 - ① Press the [SHIFT +] or [SHIFT -] button until the item you want to set starts blinking.
 - Press the [SHIFT +] button to shift the blinking to the right.
 - ("Start time (hour)" → "Start time (minute)" → "Stop time (hour)" → "Stop time (minute)" → "Record mode" → Select the day of the week.)
 - Press the [SHIFT -] button to move the blinking to the left.
 - ② Press the [SET +] or [SET -] button to set the value for the blinking item.
 - Press the [SET +] button to increase the value and the [SHIFT -] button to decrease it.
 - Set the "Start time (hour)", "Start time (minute)", "Stop time (hour)", "Stop time (minute)" and "Record mode" with the [SHIFT +/-] and [SET +/-] buttons.
- 5 Accessing another day of the week.
 - Select the "Record mode" (so that it is blinking) and press the [SHIFT +] button. Or, select "Start time" (so that it is blinking) and press the [SHIFT -] button.
 - The blinking part stops blinking. You may now select another day of the week.
- 6 To set more than one weekly timer program, repeat steps 2 to 5.
- 7 To end timer programming, press the [MENU] button twice.
 - The normal screen is restored.
 - Press the [TIMER REC] button.
 - The [TIMER] indication lights in the VCR's display. Power is switched off automatically and the VCR enters the Timer Record Standby mode.

7 RECORDING

7-3 Timer Recording

Setting dates when timer recording is not executed (cancel program)

Up to 16 days of timer-recorded programming within a year can be canceled. This function is useful for irregular days such as holidays, national holidays or special days. This setting can only be performed when the unit is turned ON.

Cancel program setting screen

PROGRAM TIMER (CANCEL)	
Month	→ 1. 1 0 - 3 0 9. -----
	2. ----- 10. -----
	3. ----- 11. -----
Day	4. ----- 12. -----
	5. ----- 13. -----
	6. ----- 14. -----
	7. ----- 15. -----
	8. ----- 16. -----
PRESS (SHIFT, SET, RESET)	
PRESS (MENU) TO END	

- 1 Display the cancel program setting screen.
Set the cursor arrow to the second line (WEEKLY) on the weekly timer program setting screen, then press the [SET+] or [SET-] button.
- 2 Press the [SHIFT+] or [SHIFT-] button to set the cursor arrow to the number of the day when timer recording is not to be executed.
- 3 Engage the Cancel Program Setting mode.
Press the [SET+] or [SET-] button.
When the [SET+] button is pressed, the month blinks.
When the [SET-] button is pressed, the day blinks.
- 4 Set the data.
Press the [SET+] or [SET-] button to set the value for the blinking item.
Press the [SET+] button to increase the value and the [SET-] button to decrease it.
*Set the "Month" and "Day" with the [SHIFT +/-] and [SET +/-] buttons.
- 5 To program additional cancel program days, repeat steps 2 to 4.
- 6 To quit the Cancel Program Setting mode, press the [MENU] button twice.
→ The normal screen is restored.

To cancel programmed data

Set the cursor arrow to the desired number and press the [RESET/CANCEL] button.

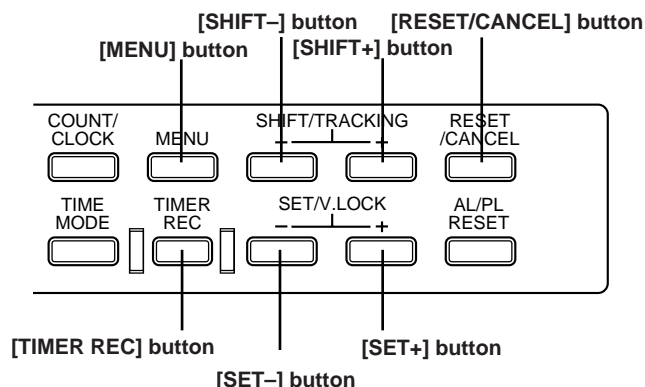

Canceling timer programming

To stop timer programming

- 1 Press the [RESET/CANCEL] button.
The program being set is canceled.
- 2 Press the [MENU] button twice.
→ The normal screen mode is restored.

To cancel a preset timer program

- 1 Press the [TIMER REC] button to turn off the **TIMER** indication in the display.
- 2 Turn the VCR and the monitor on.
- 3 Press the [MENU] button to display the main menu screen and select <PROGRAM TIMER> with the [SHIFT +/-] button. Then, press the [SET +/-] button.
→ The timer program setting screen is displayed.
- 4 Press the [SHIFT +/-] button to move the cursor arrow to the program No. or the day of the week to be canceled.
- 5 Press the [RESET/CANCEL] button.
→ The specified timer program data is canceled.
- 6 Press the [MENU] button twice.
→ The normal screen is restored.

7-3 Timer Recording

Changing a preset timer program

- 1 Press the [TIMER REC] button to turn off the [TIMER] indication in the display.
- 2 Turn the VCR and the monitor on.
- 3 Press the [MENU] button to display the main menu screen and select <PROGRAM TIMER> with the [SHIFT +/-] button. Then, press the [SET +/-] button.
→ The timer program setting screen is displayed.
- 4 Press the [SHIFT +/-] button to move the cursor arrow to the program No. or the day of the week to be changed. Press the [SET +/-] button.
- 5 Select the item to be changed (so that it is blinking) with the [SHIFT +/-] button.
- 6 Change the value with the [SHIFT +/-] button.
- 7 Press the [MENU] button twice.
→ The normal screen is restored.

Using the VCR in the Timer Record Standby mode

Press the [TIMER REC] button to turn off the [TIMER] indication for normal use.
Press the [TIMER REC] button again to turn on the [TIMER] indication. The Timer Record Standby mode is engaged. When all timer recording programs have been executed, the [TIMER] indication goes off.

Notes on timer recording

- If you make a mistake when programming
The [TIMER] indication blinks and the Timer Record Standby mode is engaged.
The blinking of the [TIMER] indication differs depending on the programming status.
 - When correct programs exist, the indication blinks for about 10 seconds and then lights.
 - If mistakes are detected in all programs, the indication blinks for about 10 seconds.



Incorrect programs are canceled automatically. So, if necessary, program the timer again.

- If no programs have been set
The [TIMER] indication blinks for about 10 seconds. The Timer Record Standby mode cannot be engaged.



Program the timer.

- If program data overlaps
The Timer Record Standby mode is engaged and the [OVER LAP] indication blinks for about 10 seconds.
The [OVER LAP] indication is not shown, however, if the DAILY timer program and WEEKLY timer program overlap.



Check the program contents.

- When program data overlaps, the timer recording priority is determined as follows.
 - ① The daily timer has priority over the weekly timer.
 - ② The program with shorter recording time (6H>L18H>L30H>48H>72H>96H>120H>168H>240H) has priority.
 - ③ The program which starts earlier has priority.
 - ④ When the start time is the same, the program with the lower program No. has priority.

- During timer recording
The PAUSE/STILL button has no effect.



To operate the VCR, first press the [TIMER REC] button.

- Timer recording
Power is turned on about 20 seconds before recording is programmed to start and the VCR enters the Record-Pause mode. Recording starts about 2 seconds before the programmed start time.
- If no cassette is loaded
The [TIMER] and ([]) indications blink.



Load a cassette with safety tab in place. Cassettes with no tab are ejected.

- When the <TAPE END MODE> function menu switch is set to STOP, REW or EJECT and the tape ends during timer recording.



The cassette is ejected.
Recording will start again when a cassette with safety tab in place is loaded.

7 RECORDING

7-4 Alarm Recording

Alarm recording functions during timelapse recording. When an alarm signal is input to the rear panel's ALARM IN terminal, an index code is recorded on the tape and the VCR automatically switches to the 6H (EP), 18H or 30H mode for realtime recording of the alarm situation. Normal timelapse recording is restored after the preset alarm recording duration has passed.

* Alarm recording will not start from the Pause mode.

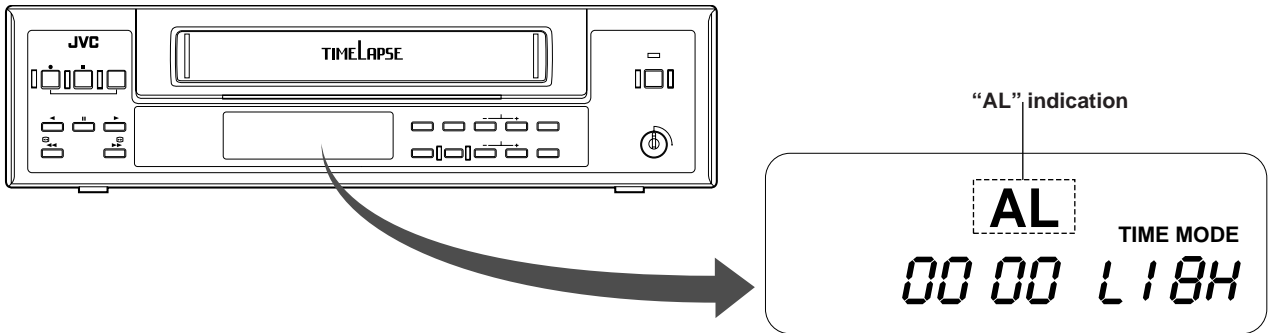

- Set the alarm recording duration, buzzer ON/OFF during alarm recording and the operation mode at the tape end during alarm recording with the function menu switches. (Menu switches for alarm/sensor recording mode setting)
- During alarm recording, the AL indication is lit on the display. After alarm recording is complete, the AL indication blinks on the display to show that an alarm signal has been input.

Display "AL" indication	Extinguished	Lit	Blinking	Lit	Blinking
Record mode	Timelapse mode	6H (EP), 18H or 30H mode	Timelapse mode	6H (EP), 18H or 30H mode	Timelapse mode
	Timelapse recording	Alarm recording	Timelapse recording	Alarm recording	Timelapse recording
		↑ Alarm signal input		↑ Alarm signal input	

* An index code (VISS) is recorded at the start point of the alarm recording as an alarm cue signal.
 * During alarm recording, a +12 V signal is output from the rear panel's ALARM REC OUT terminal.

7 RECORDING

7-4 Alarm Recording

Preparation **Connect an alarm sensor to the rear panel's alarm input terminal.**

- 1 Press the [OPERATE] button to turn the operating mode on.

Setting the function menu switches for the Alarm Record mode

- 2 Press the [MENU] button to display the main menu screen on the monitor.
- 3 Press the [SHIFT +/-] button to select <FUNCTION> and press the [SET +/-] button.

→ The function menu switch setting screen is displayed.

- 4 Press the [SHIFT +/-] button to display the alarm/sensor recording mode setting screen.

- 5 Select the item to be set with the [SHIFT +/-] button. Set the value with the [SET +/-] button.

- Set <ALARM REC> to ON to activate the alarm recording function. The AL REC indication in the display lights.
- Select the alarm record mode. Set the <REC MODE> to VHS Extended(6H), 18H or 30H.
- Set the alarm recording duration. Set duration to 5 sec., 15 sec., 30 sec., 60 sec., 120 sec., 180 sec., TAPE END or MANUAL (for as long as alarm signals are input).

* When the alarm recording time is set to MANUAL, the alarm cue signal (index code) will not be recorded correctly if alarm input lasts for less than 30 seconds.

* When alarm recording duration is set with an external switcher, set the alarm recording duration to MANUAL.

- To sound the buzzer during alarm recording, set <BUZZER> to ON.
- Set the operation mode at tape end in the case when alarm recording is executed even once with the menu switch <TAPE END MODE> on the alarm/sensor recording mode setting screen.

STOP : The tape stops.

REW : The tape is rewound to the beginning and stops.

REPEAT : Recording continues from the beginning of the tape.

EJECT : The tape is ejected.

- 6 After setting the function menu switches, press the [MENU] button twice.

→ The normal screen is restored.

Check the time and data shown on the monitor's on-screen display.

- If the time and date are not shown on the monitor or if you want to change the display position, use the <POSITION> function menu switch.

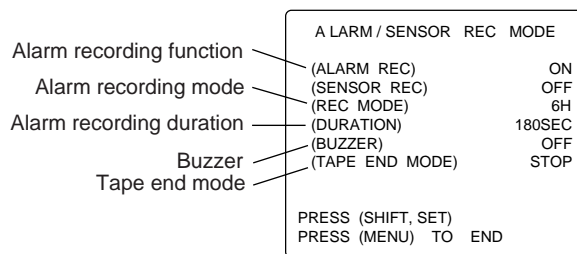

Alarm/sensor recording mode setting screen

- 7 Select the timelapse recording mode with the [TIME MODE] button on the front panel.
 - The selected recording mode is shown on the VCR's display and the on-screen display.
- 8 Follow the procedures for "Basic recording operations" on page 25.
- 9 When an alarm signal is input to the rear panel's ALARM IN terminal, alarm recording is executed as specified.
- 10 To stop alarm recording and clear the alarm indication, press the [AL/PL RESET] button.
 - When the AL indication is lit on the display (during alarm recording), press the [AL/PL RESET] button to stop alarm recording. Timelapse recording is resumed and the AL indication goes out. If the alarm buzzer is on, it stops as well.
 - When the AL indication is blinking on the display, press the [AL/PL RESET] button. The AL indication goes out.
- 11 When the AL indication goes out, press the [AL/PL RESET] button again to reset the alarm input/power loss data.

* There may be some picture distortion at the start or end of an alarm recording. This is not a malfunction.

7 RECORDING

7-5 Sensor Recording

Sensor recording is executed only when the VCR is in the Stop mode (Stop or Timer Record Standby mode) and an alarm signal is input to the rear panel's ALARM IN terminal.

Perform the settings for sensor recording in the same way as for "Alarm Recording" on page 31.

The mechanism of the SR-9168U cannot be guaranteed if the sensor recording function is used frequently (100 times/day or more). If alarm inputs are frequent, use the alarm recording function instead and carry out regular maintenance/inspection and parts replacement.

Preparation **Connect an alarm sensor to the rear panel's alarm input terminal.**

- 1 Press the [OPERATE] button to turn the operating mode on.

Setting the function menu switches for the Sensor Record mode

- 2 Press the [MENU] button to display the main menu screen.
- 3 Press the [SHIFT +/-] button to select <FUNCTION> and press the [SET +/-] button.
→ The function menu switch setting screen is displayed.
- 4 Press the [SHIFT +/-] button to display the alarm/sensor recording mode setting screen.
- 5 Select the item to be set with the [SHIFT +/-] button. Set the value with the [SET +/-] button.
 - Set the <SENSOR REC> to ON to activate the sensor recording function. The SENSOR REC indication in the display lights.
 - Select the sensor record mode.
Set the <REC MODE> to VHS Extended(6H), 18H or 30H.
 - Set the sensor recording duration.
Set <DURATION> to 5 sec., 15 sec., 30 sec., 60 sec., 120 sec., 180 sec., TAPE END or MANUAL (for as long as alarm signals are input).

- * The sensor recording time will be shorter than the specified value.
- * When the sensor recording time is set to MANUAL, the alarm cue signal (index code) will not be recorded correctly if alarm input lasts for less than 30 seconds.
- * When sensor recording duration is set with an external switcher, set the sensor recording duration to MANUAL.

- To sound the buzzer during sensor recording, set <BUZZER> to ON.
- Set the operation mode at tape end in the case when sensor recording is executed even once with the menu switch <TAPE END MODE> on the alarm/sensor recording mode setting screen.
STOP : The tape stops.
REW : The tape is rewound to the beginning and stops.
REPEAT: Sensor recording continues from the beginning of the tape.
EJECT : The tape is ejected.

Sensor recording function	A L A R M / S E N S O R R E C M O D E
Sensor recording mode	(ALARM REC) OFF
Sensor recording duration	(SENSOR REC) ON
Buzzer	(REC MODE) 6H
Tape end mode	(DURATION) 180SEC
	(BUZZER) OFF
	(TAPE END MODE) STOP
	PRESS (SHIFT, SET)
	PRESS (MENU) TO END

Alarm/sensor recording mode setting screen

- 6 After completing function menu switch setting, press the [MENU] button twice.
→ The normal screen is restored.

Check the time and data shown on the monitor's on-screen display.

- If the time and date are not shown on the monitor or if you need to change the display position, use the <POSITION> function menu switch.
- 7 • When an alarm signal is input to the rear panel's ALARM IN terminal, recording starts automatically in the specified record mode and the AL indication is lit.
 - After the specified recording duration expires, recording stops and the Stop mode is engaged.

* Because sensor recording starts from the Stop mode, it takes several seconds from the time an alarm input is received to the time recording actually starts.

- 8 To stop sensor recording and clear the AL indication, press the [AL/PL RESET] button.
- 9 To disable sensor recording, set menu switch <SENSOR REC> to OFF.

During playback, there may be some noise or picture distortion at the point where one sensor recording stops and another starts. This is not a malfunction.

7 RECORDING

7-6 Repeat Recording

When the tape reaches the end during recording, it is automatically rewound and recording starts again from the beginning.

- To execute repeat recording, set <TAPE END MODE> on the VTR mode 1 setting screen to REPEAT.
- Setting the function menu switch <TAPE END MODE> on the alarm/sensor recording mode setting screen
 - When the tape ends during recording in the case when alarm or sensor recording is executed even once, the tape stops or rewinds and stops at the beginning if this menu switch set to "STOP" or "REW",.
 - If this menu switch is set to "EJECT", the tape is ejected.
 - To continue repeat recording even when alarm/sensor recording is executed, set this menu switch to "REPEAT" .

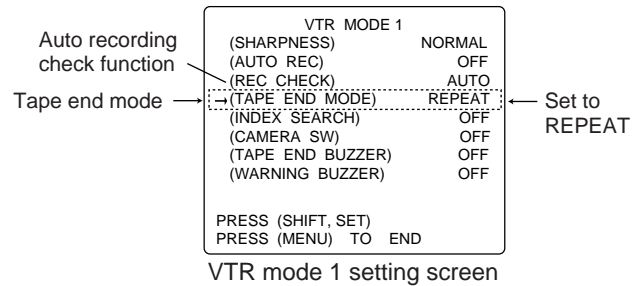

* When repeat recording is performed, the previously-recorded alarm recording is erased.

Auto Recording Check function

This function automatically checks recording quality at the beginning of the tape during repeat recording.

- To activate the Auto Recording Check function, set the <REC CHECK> function menu switch in the VTR mode 1 setting screen to AUTO.

Operation of the Auto Recording Check function

- The recorded section at the beginning of the tape is automatically played back in the Repeat Record mode and the FM level recorded on the tape is checked. If the level is satisfactory, recording continues.
- If recording quality is deemed inferior, the heads are cleaned automatically. After several seconds, recording is checked again.
- If recording quality is still unsatisfactory after two consecutive checks, the error indicator E-09 is shown in the display and recording continues.

Function menu switch <REC CHECK> set to AUTO

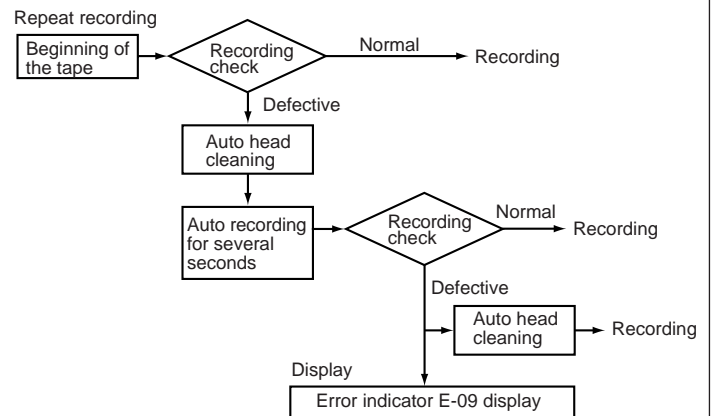

7 RECORDING

7-7 Series Recording

The series recording function facilitates recording over much longer periods using several connected SR-9168Us. As soon as the tape ends in one VCR, the next VCR in the series starts recording.

Connections

- Connect the first VCR's [SERIES/CLOCK OUT] terminal to the second VCR's [SERIES/CLOCK IN] terminal. Connect the second VCR's [SERIES/CLOCK OUT] terminal to the third VCR's [SERIES/CLOCK IN] terminal. Repeat for all connected VCRs. Connect the VCR's [COM] terminals as well.
- Connect a video camera and/or other source equipment to the first VCR's video and audio input connectors. Connect the first VCR's video and audio output connectors to the second VCR's video and audio input connectors. Connect the second VCR's video and audio output connectors to the third VCR's video and audio input connectors. Repeat for all connected VCRs. Connect the last VCR's video and audio output connectors to the monitor's video and audio input connectors.

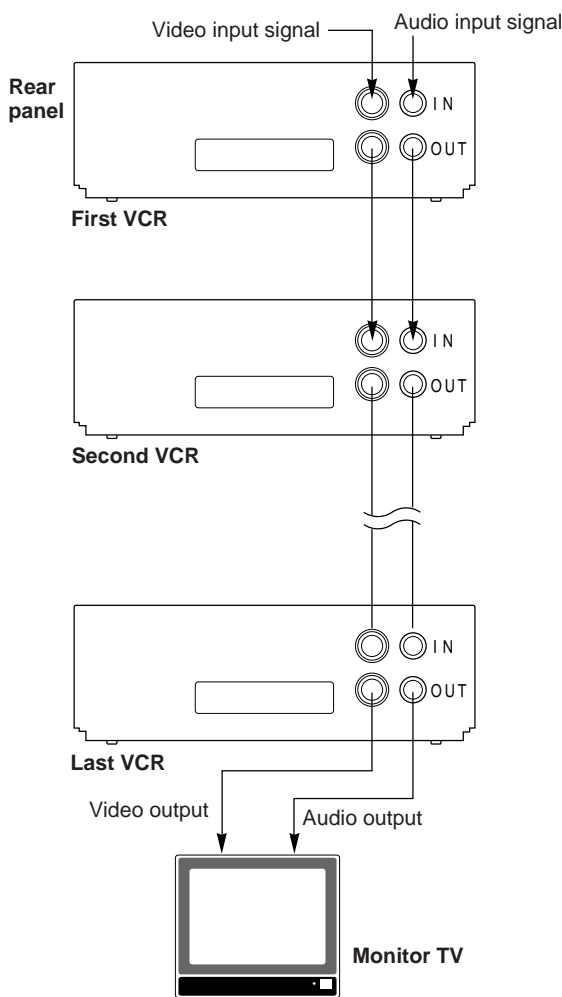

Rear panel

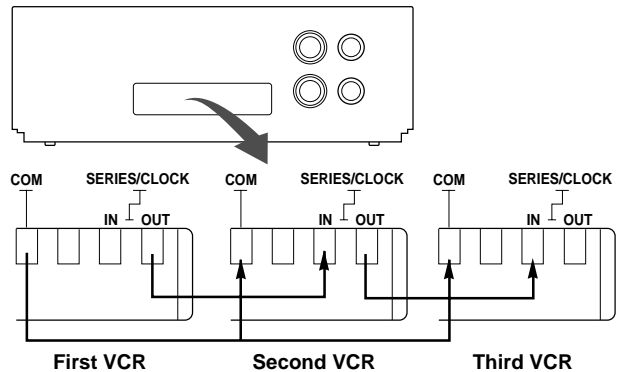

Operations

- 1 Set the <TERMINAL SEL 1> function menu switch on the VTR mode 2 setting screen to "SERIES" (series recording) for all connected VCRs.

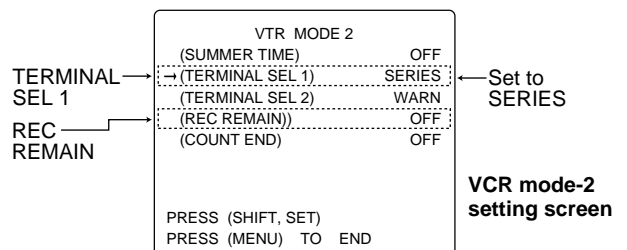

- Output a series recording signal from the [SERIES/CLOCK OUT] terminal to start recording. Set the signal output timing with <REC REMAIN> or <COUNT END>. For details, refer to "Contents of the Function Menu Switches" on page 21.
- 2 To end function setting, press the MENU button to close the menu display and restore the time/date display.
 - 3 Load cassettes with safety tab in place in all connected VCRs.
 - 4 Engage the Record mode on the first VCR. Turn on all connected VCRs and put them in the Standby mode. This allows you to check picture and sound on the monitor. When the recording is complete on the first VCR, the second VCR automatically starts recording. This is repeated for all connected VCRs.

Note

- If a cassette has not been loaded in any VCR in the series, series recording will stop when that VCR is reached.

7 RECORDING

7-8 Recording with External VCR Activation Signal

Recording start/stop can be controlled externally by inputting a VCR activation signal to the [SERIES/CLOCK IN] terminal on the SR-9168U's rear panel.

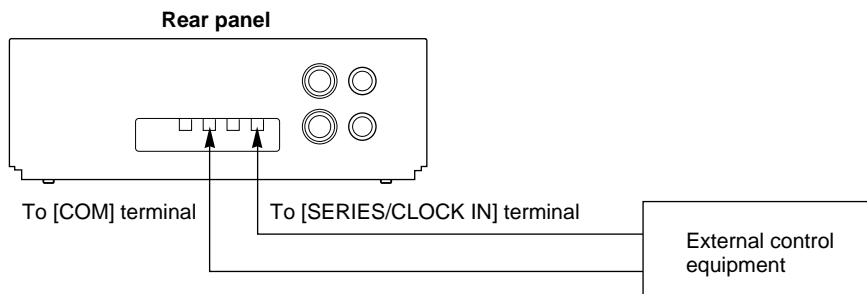

Connection

VCR control signal (ground signal)

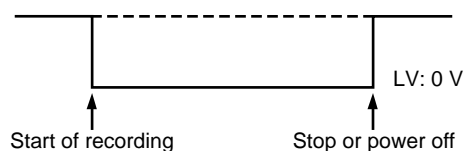

Connect the [SERIES/CLOCK IN] terminal and [COM] terminal on the SR-9168U's rear panel to the external control equipment.

Operation

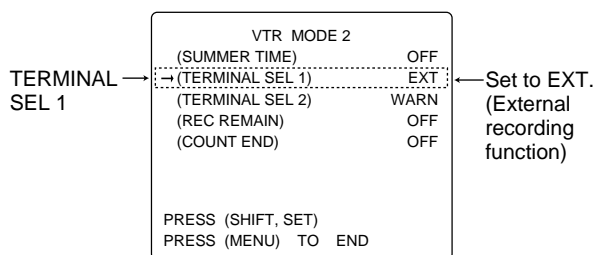

VCR mode 2 setting screen

- 1 Set the function menu switch <TERMINAL SEL 1> to "EXT" to use the external recording function.
- 2 Press the MENU button to switch the on-screen display to the time/date display.
- 3 Load a cassette with a safety tab in place and engage the Stop mode, the Pause mode or turn the operating mode off.
 - When a VCR activation signal (ground input) is input to the rear panel's [SERIES/CLOCK IN] terminal, recording starts automatically and continues for as long as the activation signal is input. When the activation signal stops, the Stop mode is engaged.
 - When the activation signal is input again, recording starts.

- When the [TIMER] indication is lit or the function is lit or the function menu switch [TAPE END MODE] on the VTR mode 1 setting screen is set to "REPEAT", this function is disabled.
- If a VCR activation signal is input while the unit is already recording (started with the [REC] button), recording continues and stops when the activation signal is no longer input.

7 RECORDING

7-9 How to Restore Recording After Power Failure

If a power failure occurs during recording, recording will restart in the same mode as soon as power is restored.

To use this function, set the function menu switch <AUTO REC> to ON.

* If this function menu switch is set to ON and power is turned off and on again in the Stop mode, the VCR enters the Record mode automatically. Be careful.

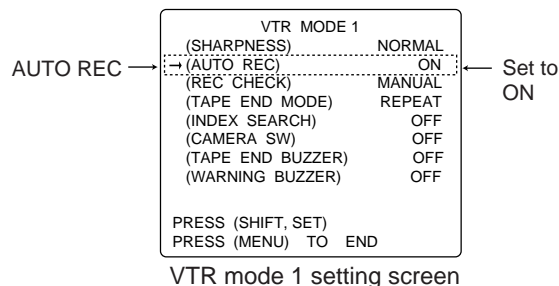

7-10 External Timer Recording

External timer recording can be performed by connecting the SR-9168U to an external timer.

- 1 Check that a cassette is loaded in the VCR.
 - * If the cassette's safety tab has been removed, recording will not take place.
 - * This function does not work when the Timer Record mode is engaged.
- 2 Set the function menu switch <AUTO REC> to ON. Power is supplied from the external timer at the specified time and recording starts.

7-11 Tape End Buzzer

When set to ON, a buzzer sounds when the tape ends during recording. To set the buzzer sound on, set the function menu switch <TAPE END BUZZER> to ON.

- Set timing for the buzzer with <REC REMAIN> or <COUNT END>. For details, refer to "Contents of the Function Menu Switches" on page 21.

When the tape reaches the specified position, the following signals are output in addition to the tape end buzzer sound.

- Tape end signal from the rear panel's [TAPE END OUT] terminal
- Series recording signal from the rear panel's [SERIES OUT] terminal during series recording
- "End" indication in the counter display

- To stop the buzzer sound, you can set the <TAPE END BUZZER> function menu switch to OFF, turn off the power, or press another operation button.
- During repeat recording and AUTO REW, the buzzer sounds for about 2 seconds.

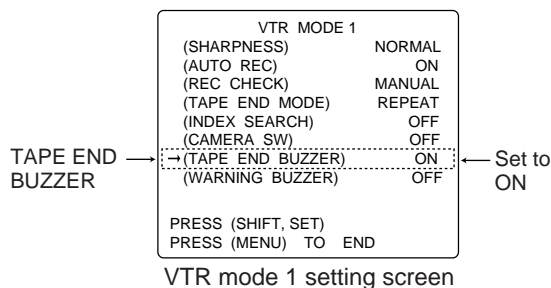

8 PLAYBACK AND SPECIAL-EFFECTS PLAYBACK

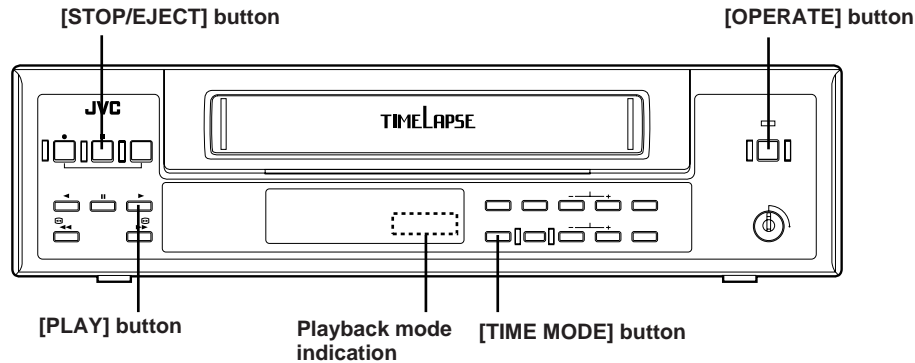

8-1 Preparation

Connection

Make sure the output connectors on the rear panel are properly connected.

Function menu switch settings

Set the function menu switches as required.

- **[SHARPNESS] . . . Factory setting: NORMAL**
Set to SHARP to emphasize contours for sharper playback pictures.
- **[INDEX SEARCH] . . . Factory setting: OFF**
To enable or disable index search.
 - Set to ON to search the alarm-recorded positions (index code).

Notes

- When a tape recorded in the 6H (EP) mode is played back in the linear slow mode (L18H or L30H), noise appears in the playback picture.
- Tapes recorded in the VHS Standard (SP) mode can be played back only. Picture quality is inferior to ordinary VHS VCRs. Still and Reverse Play modes are not available with SP tapes.
- When playing back a tape recorded in the VHS SP mode, pressing the [TIME MODE] button does not change the playback time mode.

Menu check during playback

- When the [MENU] button is pressed during playback, the monitor screen display switches from the playback picture to the input video signal (EE picture) and the main menu is shown on the screen. This means that even during playback you can check menu contents. Press the [MENU] button again to restore the playback picture.

8-2 Playback

- 1 Press the [OPERATE] button to turn the operating mode on.
 - The [OPERATE] indicator lights.
- 2 Press the [TIME MODE] button to set the Play mode to the 6H (EP).
The 6H indicator is shown on the display.

- To use playback in the linear slow Play mode, make sure the same mode (L18H or L30H) is set for playback as was used for linear slow recording.
- 3 Load the recorded cassette correctly.
 - * If a cassette is loaded when the power is off, power is switched on automatically (auto-power on function). If the cassette's safety tab has been removed, power is switched on and play starts automatically (auto play function).
- 4 Press the [PLAY] button to start play.
 - ▶ The play indicator is shown on the display and the Play mode is engaged.

- Cassettes recorded in the VHS SP mode are played back in the VHS SP mode.
 - SP indicator lights.

To stop playback

- 5 Press the [STOP] button.
The tape stops and the Stop mode is engaged.

Audio playback of a timelapse-recorded tape

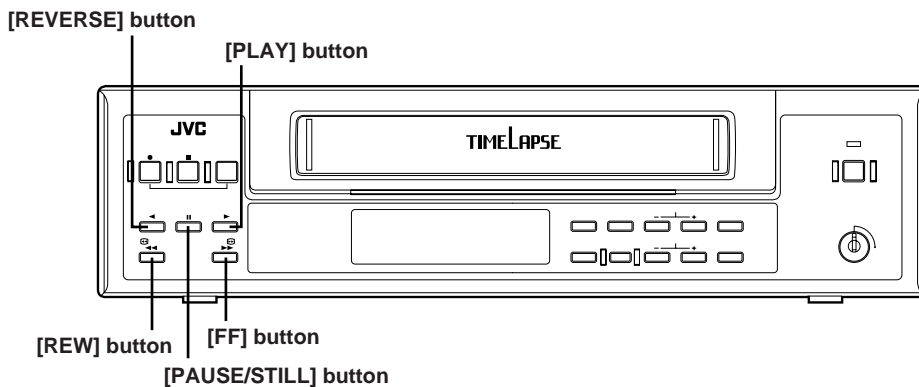

- Due to the difference in tape speed, audio signals cannot be monitored when a tape recorded in the L18H or L30H linear slow mode is played back in the VHS 6H (EP) mode.
To monitor audio recorded in the linear slow mode, play back the tape in the same mode (L18H or L30H) as it was recorded in.

8 PLAYBACK AND SPECIAL-EFFECTS PLAYBACK



8-3 Special-Effects Playback

Still and field by field advance

- 1 Press the [PAUSE/STILL] button during playback.
 -  The still indicator is shown on the display and a still picture is displayed.
- 2 ■ Each time the [PAUSE/STILL] button is pressed in the Still mode, the picture is advanced one field.
 - 
- 3 Press the [PLAY] button to restore the Normal Play mode.

The Stop mode is automatically engaged if the VCR remains in the Still mode for 5 minutes (approx.).

Reverse playback

- 1 Press the [REVERSE] button in the Play or Still mode.
 -  The reverse indicator is shown on the display and the Reverse mode is engaged.
- Reverse playback is executed at 6H (EP) mode speed. When the play time mode is set to L18H or L30H, reverse playback is executed at the 6H (EP) mode's speed.
- * No sound is output.
- 2 To return to the Normal Play mode, press the [PLAY] button.

Note
Still and Reverse Play modes are not available with tapes recorded in the Standard Play (SP) mode.

Shuttle search (reverse and fast-forward) playback

Reverse shuttle search

Press the [REW] button during play.



The rewind search indicator is shown on the display and the Reverse Shuttle Search mode is engaged.
* No sound is output.

Fast-forward shuttle search

Press the [FF] button during playback.

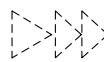

The fast-forward search indicator is shown on the display and the Fast-Forward Shuttle Search mode is engaged.
* No sound is output.

Shuttle search operations vary according to how the [REW] or [FF] button is pressed. Refer to the table below for details.

Recorded condition of the tape	Tape recorded in the 6H, L18H or L30H mode	Tape recorded in the SP mode
Operation of the [REW] or [FF] button		
Press the button once.	The tape is played back at 21 times the normal VHS EP speed. (Latch mode) Pressing the [PLAY] button resumes normal-speed playback.	The tape is played back at 7 times the normal VHS SP speed. (Latch mode) Pressing the [PLAY] button resumes normal-speed playback.
Hold the button pressed for more than 2 seconds.	The tape is played back at 13 times the normal VHS EP speed. Releasing the button resumes normal-speed playback.	The tape is played back at 7 times the normal VHS SP speed. Releasing the button resumes normal-speed playback.

• Latch mode: The Shuttle Search continues even if the button is released.

8 PLAYBACK AND SPECIAL-EFFECTS PLAYBACK

8-4 Index Search

Searching the index code (VISS signal) recorded at the start of alarm recording helps you quickly locate alarm recordings (index search function).

- To use the index search function, set the function menu switch [INDEX SEARCH] to ON.

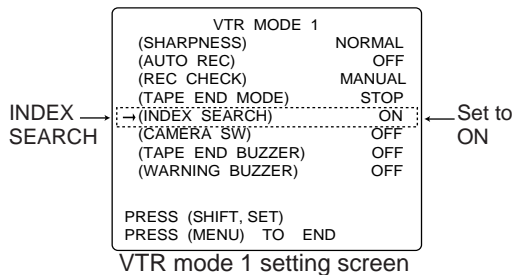

- When reverse shuttle search or fast-forward shuttle search is executed, the Index Search mode is engaged. When an index code is located, playback starts automatically.

To engage the Reverse Shuttle Search mode or the Fast-Forward Shuttle Search mode, press the [REW] or [FF] button once during playback.

- When an index code is searched in the Fast-Forward mode or the Rewind mode, the Stop mode is automatically engaged when the code is located.
 - The VISS indicator is shown on the display whenever the Index Search mode is engaged.

Index Search does not function in the Auto Rewind mode.

8-5 Tracking/V. Lock Adjustment

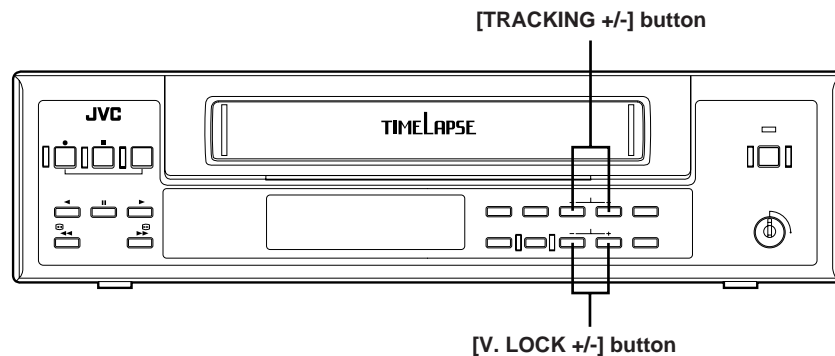

When noise appears in the picture in the Play/Field Advance Play/Search mode

- Tracking can only be adjusted in the following modes:
- VHS Standard Play, 6H (EP) Play, L18H Play and L30H Play.
 - Field Advance Playback with the [PAUSE/STILL] button
 - Search mode
- Press the [TRACKING +/-] button to reduce noise. To restore the tracking preset mode, press the + and - buttons simultaneously.

When the picture moves up and down in the Still mode

Press the [V. LOCK +/-] button to minimize vertical jitter.

9 TROUBLESHOOTING

9-1 Error Indication

Error indications are shown on the display whenever there are problems with cassette loading, unloading or mechanism operation.

- When a problem occurs, the error indication E- __ blinks.
- When any one of the error indications is shown, a 12 V warning signal is output from the rear panel's WARNING OUT connector (for E-01 to E07, and E-11 during recording) (only when the <TERMINAL SEL 2> menu function switch is set to "WARN").
- When the function menu switch <WARNING BUZZER> is set to ON, the buzzer sounds whenever a problem occurs (for E-01 to E07, and E-11 during recording).

When an error indication appears or the buzzer sounds, turn the operating mode off and then on again to clear the error indication and buzzer sound. When the error indication E- __ is shown, turning the operating mode on again may not clear the problem. In this case, consult your local JVC dealer (for E-01 to E-07).

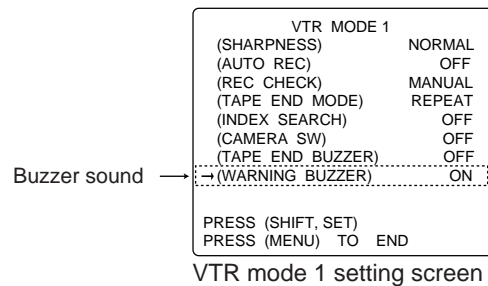
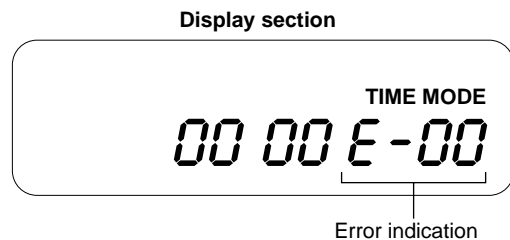

Error indication	Contents	VCR operation	Measures
E-01	Problem with loading operation	The operating mode is turned off.	Turn the operating mode on again.
E-02	Problem with unloading operation	The operating mode is turned off.	Turn the operating mode on again.
E-03	Problem with supply reel rotation	The operating mode is turned off.	Turn the operating mode on again.
E-04	Problem with drum rotation	The operating mode is turned off.	Turn the operating mode on again.
E-05	Problem with take-up reel rotation	The operating mode is turned off.	Turn the operating mode on again.
E-06	Problem with capstan rotation	The operating mode is turned off.	Turn the operating mode on again.
E-07	Problem with eject operation	The operating mode is turned off.	Turn the operating mode on again.
E-09	Error with recording check (inferior recording performance)	Cleans the heads with the VCR's head cleaner.	Cleans the heads with the head cleaning tape, then check the recording picture quality again. The tape may be defective. Replace the tape and check again. If the picture quality is still inferior, consult your local JVC dealer.
E-10	Insufficient capacity of the built-in battery for backup (Displayed only in the operating off mode.)	—	Contact your local JVC dealer to replace the built-in battery.
E-11	No video signals input to the [VIDEO IN] connector	—	Input video signals.

This unit uses a microprocessor and may not function properly if there is external noise or interference. In this case, turn the operating mode off and unplug the power cord from the AC outlet. Then plug the power cord in again and check operation.

9 TROUBLESHOOTING

9-2 No Error Indication

Symptoms	Causes	Remedies
No power is supplied.	<ul style="list-style-type: none"> ● Is the power cord disconnected? ● Is the TIMER indication shown? ● Is the Operation Lock mode engaged? 	<ul style="list-style-type: none"> ● Connect the power cord to an AC outlet. ● Press the TIMER REC button so that the TIMER indication goes out. ● Release the Operation Lock mode.
Operation buttons have no effect during recording and playback.	Is the Operation Lock mode engaged?	Release the Operation Lock mode.
No picture is shown during playback.	Is the monitor connected correctly?	Connect the monitor correctly.
Noise appears in the picture in the Shuttle Search mode and Still mode.	This is not a malfunction.	—
Noise appears in part of the playback picture.	<ul style="list-style-type: none"> ● Is the tracking adjusted properly? ● Are you playing back a tape recorded in the VHS EP (6H) mode in the linear slow mode (L18H or L30H)? In this case, noise appears in the playing picture. 	Adjust the tracking with the [TRACKING+/-] button.
When the cassette is played back, the picture becomes rough or disappears.	Dust may have accumulated on the video heads.	Clean the video heads. Consult your nearest JVC dealer.
During playback, sound is high-pitched and hard to hear.	Are you playing back a tape recorded in the L18H or L30H Timelapse mode in the VHS 6H (EP) mode? In this case, sound is high-pitched.	Play back the tape in the same mode (L18H or L30H) as that used for recording.
Recording is impossible.	Has the cassette safety tab been removed?	Paste a piece of cellophane tape over the hole.
Timer recording is working.	<ul style="list-style-type: none"> ● Is the clock set correctly? Is the timer properly programmed? ● Is the TIMER indication lit? 	<ul style="list-style-type: none"> ● Check again. ● Check it again.
The clock cannot be set.	Is the TIMER indication lit?	Press the TIMER button so that the TIMER indication goes out.
Tape running sound is heard in the Record, Play, FF and REW modes.	This is normal.	If you feel it is too noisy, install the VCR in a rack.
The time/date is not shown.	<ul style="list-style-type: none"> ● Is the clock set? ● Is the <POSITION> function menu switch set to OFF? 	<ul style="list-style-type: none"> ● Set the clock. ● Set the <POSITION> function menu switch to another position.
During recording, repeat recording does not take place.	Is the function menu switch <TAPE END MODE> in the alarm/sensor recording mode setting screen set to STOP, EJECT or REW? If so, when the tape ends during recording in the case when alarm recording is executed even once, it stops and is ejected or is rewound to the beginning and stops.	To continue repeat recording even when the alarm recording is executed, set the function menu switch <TAPE END MODE> on the alarm/sensor recording mode setting screen to REPEAT.
Camera image is not switched.	Is the <CAMERA SW> function menu switch set to "OFF"?	When setting the camera switching timing, set it to "1 FIELD" or "1 FRAME".

10. OPTIONAL SA-K97U RS-232C INTERFACE BOARD

Functions that can be controlled with front panel buttons and switches can also be controlled from a personal computer when the optional SA-K97U RS-232C interface board is installed. Operation status can also be monitored on the computer.

10-1. Installation of the SA-K97U

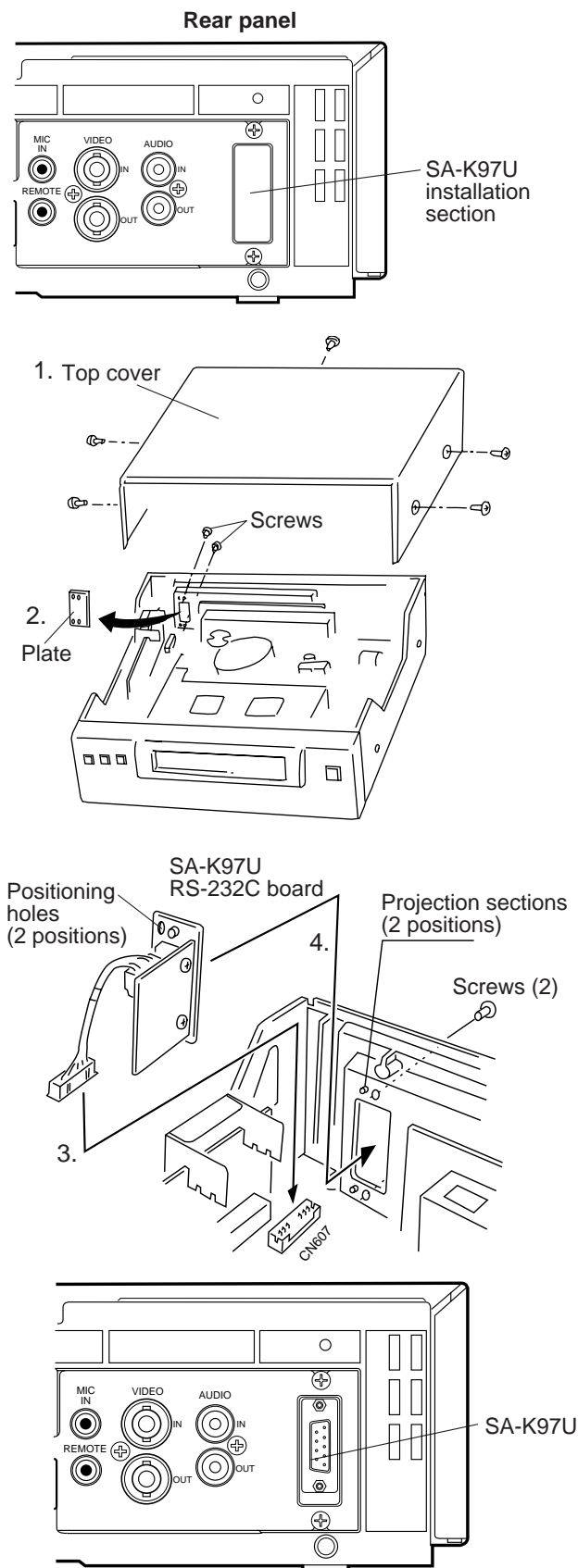

The procedure is shown below. However, to avoid electric shock or injury, contact your local JVC service center for details.

Note:

When installing this board, be careful not to injure yourself on sharp edges and metal parts inside the VCR.

- Before installing the board, turn the power off and unplug the power cord from an AC outlet.

1. Detach the top cover.
Remove the 5 screws securing the top cover and lift it off.
2. Detach the plate in the VCR.
Remove the 2 screws on the rear panel. Detach the plate from the inside of the VCR.
3. Connect the SA-K97U's connector to the VCR.
Insert the SA-K97U connector into the connector (CN607) on the board in the VCR using a tool such as a pincette.

- During insertion, make sure the connector is aligned properly.
- Press both edges of the connector to insert it securely.

4. Install the SA-K97U in the VCR.
Make sure the SA-K97U bracket is facing the correct direction and align the positioning holes on the bracket with the projections (2 positions) on the VCR's case. Secure the bracket with the 2 screws removed in step 2.
5. Attach the top cover as before.
Attach the top cover to the VCR using the 5 screws removed in step 1.
Make sure you use the correct screws.

10. OPTIONAL SA-K97U RS-232C INTERFACE BOARD

10-2. SA-K97U Specifications

9-pin connector specifications

Pin NO.	Signals	Operations	Direction of signals
2	RXD	Receive data	VTR ← CPU
3	TXD	Transmit data	VTR → CPU
4	DTR	Data terminal ready	VTR → CPU
5	GND	Signal ground	
6	DSR	Data set ready	VTR ← CPU

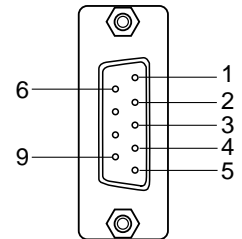

Output level
ON : +5 V or more
OFF: -5 V or less

Data format

- **Mode** : Non-synchronized
- **Character length** : 8 bits
- **Data rate** : 1200, 2400, 4800, 9600 bps
(switched with function menu switch, set to 9600 bps before shipment)
- **Parity check** : No
- **Stop bit** : 1 bit

10. OPTIONAL SA-K97U RS-232C INTERFACE BOARD

10-3. SA-K97U RS-232C Protocol & Commands

RS-232C protocol

JVC base table

	0	1	2	3	4	5	6	7	8	9	A	B	C	D	E	F
0				Data "0"	ENTER											
1	COMPLETION			Data "1"	CLEAR ERROR											
2	ERROR			Data "2"											COUNT RESET	
3	CASSETTE OUT			Data "3"							EJECT					
4				Data "4"												
5	NOT TARGET			Data "5"												
6				Data "6"		CLEAR										JVC TABLE1 ON
7				Data "7"										STATUS SENSE		JVC TABLE1 OFF
8				Data "8"												
9				Data "9"												
A	ACK			PLAY	REV PLAY								REC			REC REQUEST
B	NAK										FF		REC PAUSE			VTR INQ
C											REW					
D											F-FIELD STEP					
E																
F				STOP	STILL											

JVC table-1

	0	1	2	3	4	5	6	7	8	9	A	B	C	D	E	F
0				Data "0"	ENTER		TIMER ON	ON SCREEN ON				VISS FWD		FRAME CODE (COUNT)		
1	COMPLETION			Data "1"	CLEAR ERROR		TIMER OFF	ON SCREEN OFF				VISS REV	REC CHECK	DEVICE TYPE	AL . PL RESET	
2	ERROR			Data "2"			PRG/CLK	ROM VER						HOURLY METER SENSE	COUNT RESET	
3	CASSETTE OUT			Data "3"			SHFT+				EJECT	SEARCH (VISS)				
4				Data "4"			SHFT-	ON SCREEN SELECT								
5	NOT TARGET			Data "5"			SET+							PL .AL COUNT SENSE		
6	ALARM INPUT			Data "6"		CLEAR	SET-		TL STATUS SET					TL STATUS SENSE		JVC TABLE1 ON
7				Data "7"			CANCEL							STATUS SENSE		JVC TABLE1 OFF
8				Data "8"												
9				Data "9"			OPE LOCK ON									
A	ACK			PLAY	REV PLAY		OPE LOCK OFF						REC			REC REQUEST
B	NAK							OPERATE ON			FF		REC PAUSE			VTR INQ
C								OPERATE OFF			REW					
D								MODE SHIFT			F-FIELD STEP					
E								MODE	DATE SET			DATE S				
F				STOP	STILL				TIME SET			TIME S				

10. OPTIONAL SA-K97U RS-232C INTERFACE BOARD

10-3. SA-K97U RS-232C Protocol & Commands

This section provides technical data for programmers.

Command description

To use the commands described in the following pages, prepare the VCR for communications as follows:

Transmit the command "JVC TABLE 1 ON" (F6H) to the VCR. The VCR will return "ACK" (0AH).
 The VCR can now receive any command described in this section. To cancel the communications mode, transmit the command "JVC TABLE 1 OFF" (F7H).

2-1 VCR control commands

Commands (1) through (12) are 1-byte commands. The VCR will return "ACK" (0AH) when the command is received. Confirm that "ACK" (0AH) has been returned before transmitting the next command.

(1) OPERATE ON (7BH)	: VCR operating mode is turned "ON".
OPERATE OFF (7CH)	: VCR operating mode is turned "OFF".
(2) PLAY (3AH)	: Playback
(3) STILL (4FH)	: Pause/Still
(4) STOP (3FH)	: Stop
(5) FF (ABH)	: FF/Forward search in the Play mode. (INDEX Search when Menu switch <INDEX SEARCH> is set to ON.)
(6) REW (ACH)	: REW/Reverse search in the Play mode. (INDEX Search when Menu switch <INDEX SEARCH> is set to ON.)
(7) REV PLAY (4AH)	: Reverse playback at normal speed
(8) TIMER ON (60H)	: Timer "ON"
TIMER OFF (61H)	: Timer "OFF"
(9) OPE LOCK ON (69H)	: Operation lock "ON"
OPE LOCK OFF (6AH)	: Operation lock "OFF"
(10) EJECT (A3H)	: Cassette ejection VCR returns "ACK", and then returns CASSETT OUT (03H) after cassette has been ejected.
(11) F-FIELD STEP (ADH)	: Engages field advance when the VCR is in the Still mode. The tape is advanced by one field in the 6H/Timelapse mode. If the VCR is in any other mode, the Still mode is engaged.
(12) REC CHECK (C1H)	: Engages REC CHECK. (function is the same as when locally controlled on the VCR.)

Before transmitting either of the following commands ((13) or (14)), first transmit REC/DUB REQUEST (FAH), and confirm that "ACK" is returned by the VCR.

(13) REC (CAH)	: Starts recording. The VCR returns "ACK".
(14) REC PAUSE (CBH)	: Engages Record-Pause mode. The VCR returns "ACK". <ul style="list-style-type: none"> • To re-start recording, transmit REC (FAH+CAH). • To cancel Record-Pause, transmit STOP (3FH). The VCR will enter the Stop mode.

However, if the loaded cassette's safety tab has been removed, recording is not possible regardless of the fact that "ACK" has been returned. Use the STATUS SENSE (D7H) command to confirm tape status. (See Section 2-3 (9)).

After transmitting commands VISS FWD (15) or VISS REV (16), transmit the appropriate numeric data (1-byte ASCII codes from 30H to 39H) and the data input command (40H).

ASCII codes "30H – 39H" correspond with the numbers "0 – 9" (ie.: 0: 30H, 1: 31H, ... 9: 39H).

Each byte of numeric data and the data input command should be transmitted separately with "ACK" (0AH) confirmation from the VCR after each transmission. The VCR's Menu switch <INDEX SEARCH> is set to OFF.

(15) VISS FWD (B0H)	: To advance the tape in the forward search mode to the designated alarm-input point. The alarm point's 2-byte numeric data should be input after transmission of this command.
(16) VISS REV (B1H)	: To reverse the tape in the reverse search mode to the designated alarm-input point. The alarm point's 2-byte numeric data should be input after transmission of this command.

Eg: To search for the 3rd alarm-input point from the current position.

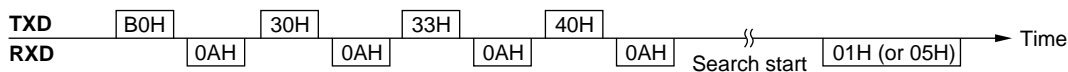

The VCR starts INDEX search after returning "ACK". When the specified point is reached, the VCR returns COMPLETION (01H). If the end or beginning of the tape is reached before the specified point, the VCR returns NOT TARGET (05H). (Sending either the 30H,30H or 30H,31H command will cause the VCR to search for the 1st alarm-input point).

10. OPTIONAL SA-K97U RS-232C INTERFACE BOARD

After transmitting the VISS SEARCH command (17), transmit the appropriate 2-byte numeric data (from 30H to 39H), the data input command (40H), and either FF (ABH) or REW (ACH). All commands should be transmitted separately one byte at a time with "ACK" (0AH) confirmation from the VCR after each transmission.

(17) VISS SEARCH (B3H) : To search for a designated INDEX point on the tape.
 The VCR starts INDEX search after returning "ACK". When the specified point is reached, the VCR returns COMPLETION (01H). If the end or beginning of the tape is reached before the specified point, the VCR returns NOT TARGET (05H).
 This command differs from commands (15) and (16) only in that the FF (ABH) or REW (ACH) command is included separately.

2-2 VCR setting commands

Commands available include control of recording/playback mode setting, timelapse VCR operation mode setting, date and time setting, timer programming, on-screen setting, and others.

Recording/playback mode setting commands

Two commands are available. One allows you to rotate through recording/playback modes, the other permits you to directly select the mode.

(1) MODE SHIFT (7DH) : Switches from one recording/playback mode to the next each time the command is transmitted. Use the TL STATUS SENSE (D6H) command to check the current mode. (See section 2-3 (8).) Transmit 1 byte at a time with "ACK" (0AH) confirmation from the VCR after each transmission.

(2) MODE (7EH) : Sets recording/playback mode directly. After transmitting this command, transmit the appropriate 2-byte ASCII codes (from 30H to 39H) and the data input command (40H). Correspondence of ASCII codes with recording/playback modes is as shown below.

Eg: To set to "L18H".

Mode	1st byte	2nd byte
(SP	30H	30H)
6H	30H	31H
L18H	30H	33H
L30H	31H	37H
48H	30H	34H
72H	30H	35H
96H	31H	36H
120H	30H	37H
168H	30H	38H
240H	30H	39H

Modes in parentheses are available only in the Play mode.

Timelapse VCR operation mode setting commands

(1) TL STATUS SET (86H) : Set the timelapse VCR operation mode with 3-byte data. Send one byte at a time by checking ACK (0AH) from the VCR.

• The setting details for the first to the third bytes are shown below.

1st byte		2nd byte	
BIT	When the bit is "1"	BIT	When the bit is "1"
0	Repeat recording function ON	0	Unused
1	Unused	1	Alarm recording function ON
2	Auto REC mode ON	2	Unused
3	Auto rewind ON	3	Sensor recording function ON
4	Unused	4	External recording function ON
5	Series recording function ON	5	Unused
6	Tape end buzzer ON during recording	6	Index search function ON
7	Alarm recording buzzer ON	7	Warning buzzer ON

3rd byte	
BIT	When the bit is "1"
0	Unused
1	Summer time ON
2	Unused
3	Unused
4	Unused
5	Always 0.
6	Unused
7	Unused

10. OPTIONAL SA-K97U RS-232C INTERFACE BOARD

■ Date and time setting commands

- (1) DATE SET (8EH) : Set the current date (month, day, year) for the VCR. After this command (8EH) is sent, input 1-byte numerical data (30H — 39H).

(Example) Sep., 30, 1998

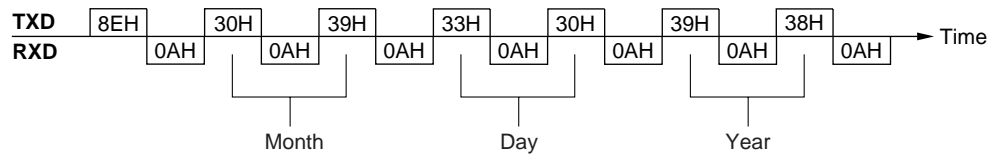

- (2) TIME SET (8FH) : Set the current time (hour, minute, second) for the VCR. After this command (8FH) is sent, input 1-byte numerical data (30H — 39H).

(Example) 15 hours, 29 minutes, 59 seconds

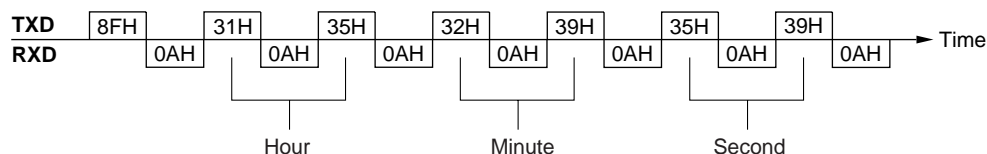

■ Timer programming commands

- (1) PRG/CLK (62H) : Engages timer programming mode.
 (2) SHIFT - (64H) : Selects setting items. (-)
 SHIFT + (63H) : Selects setting items. (+)
 (3) SET - (66H) : Sets data selected with SHIFT.
 SET + (65H) : Sets data selected with SHIFT.
 (4) CANCEL (67H) : Cancels program data in timer programming or engages the Cancel Program mode.

Setting procedure is the same as when using the VCR controls. Be sure to transmit commands 1 byte at a time with "ACK" (0AH) confirmation from the VCR after each transmission.

■ On-screen setting command

- (1) ON SCREEN ON (70H) : Activates time/date on-screen indication.
 ON SCREEN OFF (71H) : Deactivates on-screen indication.

Setting procedure for the following command (2) is the same as when using the VCR controls. Be sure to transmit commands 1 byte at a time with "ACK" (0AH) confirmation from the VCR after each transmission.

- (2) ON SCREEN SELECT (74H) : Changes the time display position on screen.

■ Other commands

- (1) AL/PL RESET (E1H) : When transmitted during alarm recording, the recording mode switches back to the previous mode. The VCR's "AL" indication goes off. Transmit again after "AL" indicator goes off to reset the alarm/power loss memory.
 (2) COUNT RESET (E2H) : Resets the tape counter to "0000".

10. OPTIONAL SA-K97U RS-232C INTERFACE BOARD

2-3 Commands for VCR status verification

- (1) DATE SENSE (BEH) : The VCR returns the currently set month, day and year as 6 bytes. Each byte has a value of 30H to 39H. 30H corresponds to 0 and 39H to 9.
(Example: For Sep., 14, 1999, the VCR returns 30H, 39H, 31H, 34H, 39H and 39H.)
- (2) TIME SENSE (BFH) : The VCR returns the currently set hour, minute and second as 6 bytes. Each byte has a value of 30H to 39H. 30H corresponds to 0 and 39H to 9.
(Example: For 15:30:45, the VCR returns 31H, 35H, 33H, 30H, 34H and 35H.)
- (3) COUNT CODE (D0H) : VCR returns the counter data beginning with the 4th digit from the right in 4 bytes. ASCII codes "30H – 39H" correspond with the numbers "0 – 9" (eg: 1234: 31H, 32H, 33H, 34H).
- (4) DEVICE TYPE (D1H) : VCR returns the last 4 characters of the SR-9168 model name in ASCII code.
9: 39H, 1: 31H, 6: 36H, 8: 38H
- (5) VTR INQ (FBH) : Used to make sure that the connected unit is the VCR. The VCR will return "ACK" (0AH).
- (6) PL/AL COUNT SENSE (D5H) : VCR will return a total of 6 bytes. The first 3 bytes show the number of alarm inputs in 3 digits and the last 3 bytes show the number of power losses in 3 digits. ASCII codes "30H – 39H" correspond with the numbers "0 – 9" (eg: 123 alarm inputs and 45 power losses: 31H, 32H, 33H, 30H, 34H, 35H).
- (7) HOUR METER SENSE (D2H) : VCR returns the hour meter data in 5 bytes. (eg: 12345 hours: 31H, 32H, 33H, 34H, 35H).
- (8) TL STATUS SENSE (D6H) : VCR returns Timelapse mode data in 6 bytes. The contents of each byte are as follows:

1st/2nd byte

Recording/playback mode

Correspondence of the code and the mode is the same as that described in "2-2 Recording/playback mode setting commands (2) MODE (7EH)".

3rd byte

Conditions of each setting

BIT	Status when BIT is "1".
0	Not defined. Always 0.
1	Power is ON.
2	Auto REC mode is ON.
3	Auto rewind mode is ON.
4	Operation lock is ON.*
5	Series recording is ON.
6	Tape end buzzer is ON.
7	Alarm buzzer is ON.

5th byte

Settings status

BIT	Status when BIT is "1".
0	Always 1.
1	SUMMER TIME is ON.
2	Always 0.
3	Always 0.
4	Always 0.
5	Always 0.
6	Always 0.
7	Always 0.

4th byte

Conditions of each setting

BIT	Status when BIT is "1".
0	Alarm recording is in progress.
1	ALARM REC function is ON.
2	Not defined. Always 0.
3	Sensor recording is ON.
4	External recording function is ON.
5	Always 0.
6	Index search mode is ON.
7	Warning buzzer is ON.

6th byte

Types of warnings

HEX.Data	Types of warnings
0	No abnormality
1	Loading error
2	Unloading error
3	Supply reel error
4	Drum error
5	Take-up reel error
6	Capstan error
7	Cassette eject error
8	Not defined.
9	Recording check error
A	Battery backup error
B	Input signal error

* Operation with commands from the RS-232C is accepted even in the Operation Lock mode.

10. OPTIONAL SA-K97U RS-232C INTERFACE BOARD

(9) STATUS SENSE (D7H) : The VCR will return current status information in 5 bytes.

1st byte	
BIT	Status when BIT is "1".
0 Error	Indicates that an illegal command has been received. No further commands will be accepted. To restore to normal operation, transmit CLEAR ERROR (41H) to the VCR.
1 Not defined	Always 0.
2 Not defined	Always 0.
3 Cassette out	The tape has not been loaded.
4 REC inhibit	A tape with no safety tab has been loaded. In this case, no recording commands will be accepted.
5 Not defined	Always 0.
6 Not defined	Always 0.
7 Not defined	Always 1.
2nd byte	
BIT	Status when BIT is "1".
0 Tape End	Tape end sensor is detected.
1 Tape Begin	Tape begin sensor is detected.
2 Not defined	Always 0.
3 Warning	VCR malfunction.*
4 Not defined	Always 0.
5 Not defined	Always 0.
6 A EE Mode	An externally-input audio signal is being output.
7 V EE Mode	An externally-input video signal is being output.
3rd byte	
BIT	Status when BIT is "1".
0 Not defined	Always 0.
1 Search Mode	Search is in progress. (VISS)
2 Repeat Mode	Repeat recording/playback is in progress.
3 Not defined	Always 0.
4 Repeat	VCR's REPEAT REC switch is set to ON.
5 Not defined	Always 0.
6 Timer REC ON	VCR's TIMER button is set to ON.
7 Not defined	Always 0.
4th byte	
BIT	Status when BIT is "1".
0 Not defined	Always 0.
1 REC Mode	VCR is in the Record mode.
2 Eject	A cassette is being ejected.
3 Not defined	Always 1.
4 Stop Mode	VCR is in the Stop mode.
5 REW Mode	VCR is in the Rewind mode.
6 FF Mode	VCR is in the Fast-Forward mode.
7 Play Mode	VCR is in the Play mode.
5th byte	
BIT	Status when BIT is "1".
0 Speed Code 0	VCR's current tape running mode. See below.
1 Speed Code 1	VCR's current tape running mode. See below.
2 Speed Code 2	VCR's current tape running mode. See below.
3 Speed Code 3	VCR's current tape running mode. See below.
4 Shuttle REV	Reverse search is in progress.
5 Shuttle FWD	Forward search is in progress.
6 Not defined	Always 0.
7 Pause Mode	VCR is in the Pause mode.
Contents of 5th byte BIT 0/1/2/3 "Speed Code"	
Speed Code	3 2 1 0
BIT	0 0 0 0 Still
	0 0 0 1 Timelapse playback
	0 1 0 1 Timelapse recording/6H (EP) playback
	1 0 0 1 Search(X13 or X21)

* When an error occurs in the VCR and the Warning mode is engaged, the third bit of the second byte sent back with the STATUS SENSE (D7H) is set to "1", showing the warning status. In this case, release the warning via the RS-232C with the CLEAR (56H). To release it on the VCR, turn the [OPERATE] button off and on again.

(10) ALARM INPUT (06H) : SR-9168U return code
This is returned when an alarm signal is input during recording.

10. OPTIONAL SA-K97U RS-232C INTERFACE BOARD

2-4 Others (Input data correction/Error cancellation)

These are return codes from the SR-9168U. (Error-related codes only)

(1) ERROR (02H) : This is returned when commands of more than 1 byte are transmitted to the VCR and an illegal command is received in the 2nd byte (or later) of the transmitted command.
In this status, no command can be accepted and only STATUS SENSE will be returned.
To restore normal operation, transmit CLEAR ERROR (41H) or CLEAR (56H) to the VCR.

CLEAR ERROR (41H)	: Used to cancel previously-transmitted 1-byte numeric data when inputting numeric data such as an Index search point. Also used to cancel error status.
CLEAR (56H)	: Clears the whole command. Cancels the current status and stops the VCR. Also cancels the error status.

Eg : After setting the recording/playback mode to "L18H", 32H is mistakenly transmitted . Cancel 32H with "41H" and input "33H" instead.

(2) NAK (0BH) : VCR will return this code when non-defined or non-functional command is received in the 1st byte of the transmitted command. In this case, it is not necessary to input CLEAR. Check whether the transmitted command is acceptable to the VCR or not.

3 Commands reference chart

VCR control commands	
	Page
OPERATE ON/OFF	46
PLAY/REV PLAY	46
STOP	46
FF/REW	46
TIMER ON/OFF	46
OPE ON/OFF	46
EJECT	46
F-FIELD STEP	46
REC CHECK	46
REC/REC PAUSE	46
VISS FWD/REV	46
VISS SEARCH	47

VCR setting commands	
	Page
■ Recording/playback mode	47
MODE SHIFT	47
MODE	47
■ Timelapse VCR operation mode	47
TL STATUS	47
■ Date and time setting	48
DATE SET	48
TIME SET	48
■ Timer programming	48
PRG	48
SHIFT -/+	48
SET -/+	48
CANCEL	48
■ On-screen setting	48
ON SCREEN ON/OFF	48
ON SCREEN SELECT	48
■ Others	48
AL/PL RESET	48
COUNT RESET	48

Commands for VCR status verification		
	Page	Byte returned from VCR
COUNT CODE	49	4 bytes
DEVICE TYPE	49	4 bytes
VTR INQ	49	1 byte
PL/AL COUNT SENSE	49	6 bytes
HOUR METER SENSE	49	5 bytes
TL STATUS SENSE	49	6 bytes
STATUS SENSE	50	5 bytes
DATA SENSE	49	6 bytes
TIME SENSE	49	6 bytes

Return codes from VCR	
	Page
ACK	46
NAK	51
ERROR	51
CASSETTE OUT	46
COMPLETION	46
NOT TARGET	46
ALARM INPUT	50

Others	
	Page
JVC TABLE 1 ON/OFF	46

11 APPENDIXES

11-1 Rear Panel's Input/Output

[CAM SW OUT] camera switching signal output

The CAM SW OUT terminal outputs a camera switching timing signal to the connected sequential switcher. The switching interval can be set with the <CAMERA SW> on the VTR mode 1 setting screen. The camera switching signal is output at ground level.

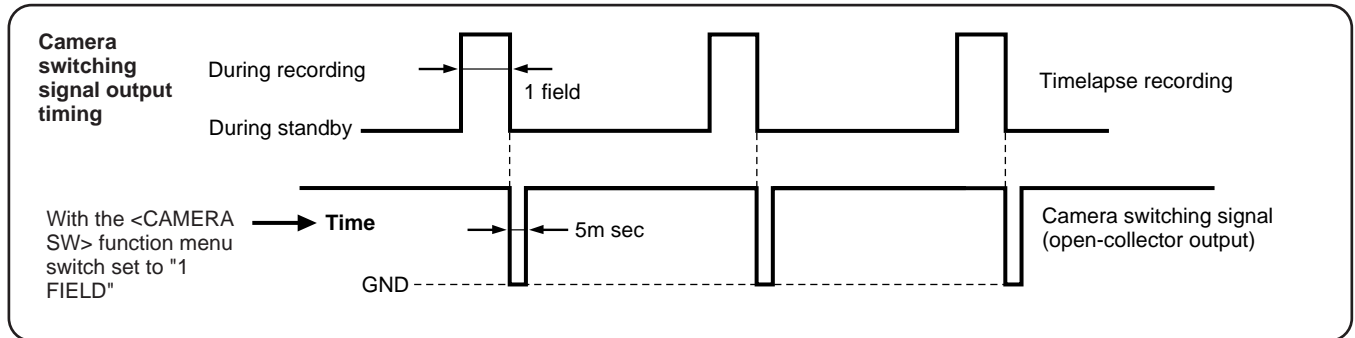

Other input/output terminal signal levels

Terminals	Signal levels	Remarks
ALARM IN Alarm signal input		Input at ground level
ALARM RST IN Alarm signal reset input		Input at high level
ALARM REC OUT Alarm recording mode signal output		Output at high level
TAPE END OUT Tape end signal output	Record mode: repeat recording ON/auto rewind ON Record mode: repeat recording OFF/auto rewind OFF 	Output at ground level
WARNING/REC OUT Warning signal/Rec mode signal output		Output at high level
CLOCK RESET IN Clock reset input		Input at ground level
CLOCK RESET OUT Clock reset output		Output at ground level

11-2 Specifications

- **Recording system** Luminance: FM recording
Color: down-converted direct recording
- **Signal system** NTSC-type color signal, EIA monochrome signal, 525 lines/60 fields
- **Tape speed** 11.12 mm/sec., 6H mode (EP)
- **Recording and playback time** 2 hours (VHS Standard mode: playback only)
6 hours (EP mode)
18, 30, 48, 72, 96, 120, 168, 240 hours (Timelapse mode: field recording) (with T-120 cassette)
- **Fast-forward/rewind time** Within 4 minutes (with T-120 cassette)
- **Power supply** AC 120 V, 50/60 Hz
- **Power consumption** 16 watts

- **Dimensions** 360 (W) x 94 (H) x 288 (D) mm
- **Weight** Approx. 5 kg
- **Operating temperature** 5°C — 40°C
- **Operating humidity** 30%RH or more, 80%RH or less
- **Storage temperature** -20°C — 60°C

[Video System]

- **Signal input** 0.5 — 2.0 Vp-p, 75 ohms, unbalanced BNC
- **Signal output** Signal output 1.0 Vp-p, 75 ohms, unbalanced BNC
- **Horizontal resolution** Color mode: 230 lines or more (6H mode)
- **Video S/N** 43 dB or more (6H mode)

[Audio system]

- **Number of tracks** 1 (normal)
- **Line input** -8 dBs, 50 kohms, unbalanced RCA
- **Mic input** -67 dBs, 600 ohms, unbalanced
- **Line output** -8 dBs, 1 kohm, unbalanced RCA
- **Frequency response** 100 Hz — 5 kHz (6H mode)
- **Audio S/N** 40 dB or more (6H mode at 4% distortion level)
- **Wow and flutter** 0.25% WRMS or less (6H mode)

[Time/date]

- **Display** Month, day, year, hours, minutes, seconds, recording mode
- **Display position** Variable (four corners)
- **Character size** 16H
- **Power backup** Approx. five years (may be less depending on the operating environment)

[Alarm]

- **Alarm input** Input at ground level
- **Camera switching output** Negative pulse output (5 msec.)
Open-collector output

[Accessories]

- **Operation-lock key** X 2

Outer dimensions

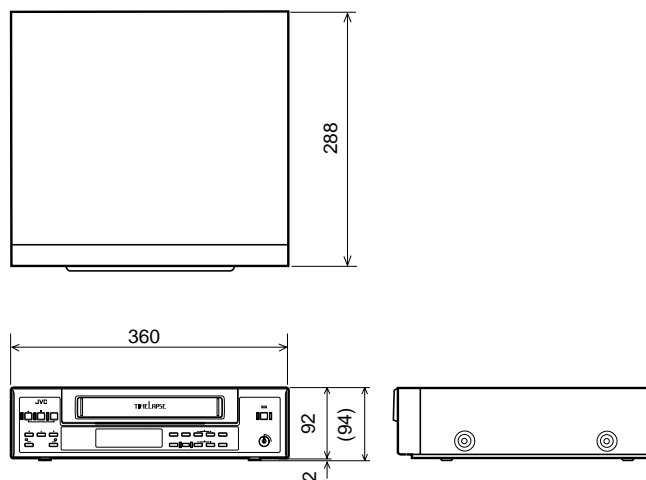

Unit: mm

* Design and specifications subject to change without notice.



JVC® is a registered Trademark owned by VICTOR COMPANY OF JAPAN, LTD.
JVC® is a registered Trademark in Japan, the U.S.A., the U.K. and many other countries.

© 1999 VICTOR COMPANY OF JAPAN, LIMITED



Printed in Japan
SL96170

Free Manuals Download Website

<http://myh66.com>

<http://usermanuals.us>

<http://www.somanuals.com>

<http://www.4manuals.cc>

<http://www.manual-lib.com>

<http://www.404manual.com>

<http://www.luxmanual.com>

<http://aubethermostatmanual.com>

Golf course search by state

<http://golfingnear.com>

Email search by domain

<http://emailbydomain.com>

Auto manuals search

<http://auto.somanuals.com>

TV manuals search

<http://tv.somanuals.com>