

jWIN

Portable CD player with Cassette and AM/FM Radio



Instruction Manual

JX-CD438

Please read this manual carefully before operating and save it for future reference.

Have a question? Please visit <http://www.jWIN.com>

USER SAFETY GIUDE

IMPORTANT SAFETY INSTRUCTIONS

WARNING: To prevent fire or shock hazard, do not expose this appliance to rain or moisture.



CAUTION
RISK OF ELECTRIC SHOCK
DO NOT OPEN



These markings are located on the bottom, side or back of the unit.

CAUTION: To prevent the risk of electric shock, do not remove cover (or back). Non- user-serviceable parts inside. Refer servicing to a service professional.

- The lightning flash with an arrowhead symbol, within an equilateral triangle, is intended to alert the user to the presence of un-insulated "dangerous voltage" within the product's enclosure that may be of sufficient magnitude to constitute a risk of electric shock to a person.
- The exclamation point within an equilateral triangle is intended to alert the user to the presence of important operating, maintenance and servicing instructions in the literature accompanying the appliance.

Dripping warning: "This product shall not be exposed to any dripping or splashing, and no objects filled with liquids, such as vases, shall be placed on or near the product."

Ventilation warning: "The normal ventilation of the product shall not be impeded for intended use." (Minimum distances must be kept around the apparatus for sufficient ventilation, especially while use of the apparatus is in tropical and/or moderate climates.)

	<p>Dispose of old batteries safely. Do not throw them into a fire.</p>
	<p>LASER SAFETY This unit utilizes laser technology. Only a qualified professional should remove the cover or attempt to service this device, due to possible eye injury.</p> <p>CAUTION</p> <ul style="list-style-type: none"> • Use of controls or adjustments or performance of procedure other than specified herein may result in hazardous radiation exposure. • Hazardous laser radiation when open and interlock defeated. <p>DANGER Invisible laser radiation when open and interlock failure. Avoid direct exposure to beam.</p>

USER SAFETY GUIDE

INSTRUCTIONS ON ENVIRONMENT PROTECTION

Do not dispose of this product in the usual household garbage at the end of its life cycle; bring it to a collection point for the recycling of electrical and electronic appliances. This symbol on the product means the instructions for use or the packing will inform about the methods for disposal. The materials are recyclable as mentioned in its marking. By recycling, material recycling, or other forms of re-utilization of old appliances, you make an important contribution to protect the environment. Please inquire at your local community administration for the authorized disposal location.



IMPORTANT SAFETY PRECAUTIONS

1. **READ INSTRUCTIONS** - All safety and operating instructions should be read before the appliance is operated.
2. **RETAIN INSTRUCTIONS** - The safety and operating instructions should be retained in a secure place for future reference.
3. **HEED WARNINGS** - All warnings on the appliance and in the operating instructions should be observed.
4. **FOLLOW INSTRUCTIONS** - All operating and use instructions should be followed.
5. **WATER AND MOISTURE** - The appliance should not be used near water. For example: near a bathtub, kitchen sink, laundry tub, and swimming pool or even in a wet basement.
6. **VENTILATION** - The appliance should be situated so that its location and position does not interfere with its proper ventilation. For example, the appliance should not be situated on a bed, sofa, rug or similar surface that may block the ventilation openings; or, be placed in a built-in installation, such as a bookcase or cabinet that may impede the flow of air through the ventilation openings.
7. **HEAT** - The appliance should be situated away from heat sources such as radiators, heat registers, stoves, or other appliances (including amplifiers) that produce heat.
8. **POWER SOURCES** - The appliance should be connected to a power supply only of the type described in the operating instructions or as marked on the appliance.
9. **GROUNDING AND POLARIZATION** - Precautions should be taken to ensure that the grounding or polarization of the appliance is correct.
10. **POWER CORD PROTECTION** - Power supply cords should be routed so that they are not likely to be walked on or obstructed by items placed upon or against them. Pay particular attention to cords at plugs, convenience receptacles, and the point at which they exit from the appliance.
11. **CLEANING** - The appliance should be cleaned only as recommended by the manufacturer.
12. **POWER LINES** - An outdoor antenna should be located away from power lines.
13. **NONUSE PERIODS** - The power cord of the appliance should be unplugged from the outlet when the appliance is to be left unused for an extended period of time.

USER SAFETY GUIDE

IMPORTANT SAFETY PRECAUTIONS – CONTINUED

14. **OBJECT and LIQUID ENTRY** - Care should be taken so that objects do not fall and liquids are not spilled into the device's openings.
15. **CARTS AND STANDS** - The appliance should be used only with a cart or stand that is recommended by the manufacturer. An appliance and cart combination should be moved with care. Quick stops, excessive force, and uneven surfaces may cause the appliance and cart combination to overturn. 
16. **WALL OR CEILING MOUNTING** - If the appliance is mounted to a wall or ceiling, it should be mounted only as recommended by the manufacturer.
17. **DAMAGE REQUIRING SERVICE** - The appliance should be serviced by qualified service professional when:
 - a. The power-supply cord or plug has been damaged.
 - b. Objects have fallen into, or liquid has been spilled into the appliance's apertures.
 - c. The appliance has been exposed to rain.
 - d. The appliance has been dropped and suffered damage.
 - e. The appliance does not appear to operate normally or exhibits a marked change in performance.
18. **SERVICING** - The user should not attempt to service the appliance beyond that described in the user's operating instructions. All other servicing should be referred to qualified service professional.
19. **PROTECTIVE ATTACHMENT PLUG** - The appliance is equipped with an attachment plug that has an overload protection. This is a safety feature. If replacement of the plug is required, be sure the service technician has used a replacement plug specified by the manufacturer that has the same overload protection as the original plug. (UK Version Only)

FCC NOTICE (USA)

This device complies with Part 15 of the FCC Rules. Operation is subject to the following two conditions: (1) this device may not cause harmful interference, and (2) this device must accept any interference received, including interference that may cause undesired operation.

FCC regulations state that any change or modification to the equipment, not expressly approved by maker or its authorized parties, could void user's authority to operate this equipment.

- To prevent fire or electric shock, do not expose the unit to rain or moisture.
- Never attempt to open the cabinet. Dangerous high voltages are present in the unit. Always refer servicing to a qualified technician.

IC NOTICE (CANADA)

This digital apparatus does not exceed the Class B limits for radio noise emissions from digital apparatus as set out in the Radio Interference Regulations of Industry Canada.

TABLE OF CONTENTS

1. Getting Started	
a. Introduction	5
b. Location of Controls for unit	6
c. AC operation.....	7
d. Battery operation.....	7
e. FM Antenna.....	7
2. Operational Instructions	
a. Listening to the Radio.....	8
b. Listening to Cassettes.....	8
c. Recording to Cassettes.....	8
d. Listening to CDs.....	8
e. Audio CD Playback.....	9
f. Play/Pause Mode.....	9
g. Skip and Search Mode.....	9
h. Repeat Mode.....	10
i. Program Mode	10
3. Maintenance & Specifications	
a. Notes on CDs	12
b. Cleaning the lens	12
c. Cleaning the cabinet	12
d. Troubleshooting.....	13
e. Technical specifications	14

GETTING STARTED

Thank you for purchasing the JX-CD438. Unpack the unit and make sure to put aside all accessories so they will not be lost. We recommend that you retain the original carton and packaging materials for future use, should you transport or ship the unit in the future.

Portable stereo audio system

- Fully Programmable Stereo CD Player
- Digital LED Display for CD
- Analog AM / FM Radio
- Cassette Records from CD and AM/FM Radio
- 20 Tracks program playback
- Repeat One & Repeat All CD Play Modes
- Skip & Search CD Play Functions
- Telescoping FM Antenna
- Folding Handle

What's included

- Portable CD Boom box
- Instruction manual
- Warranty card



GETTING STARTED

Location of Controls

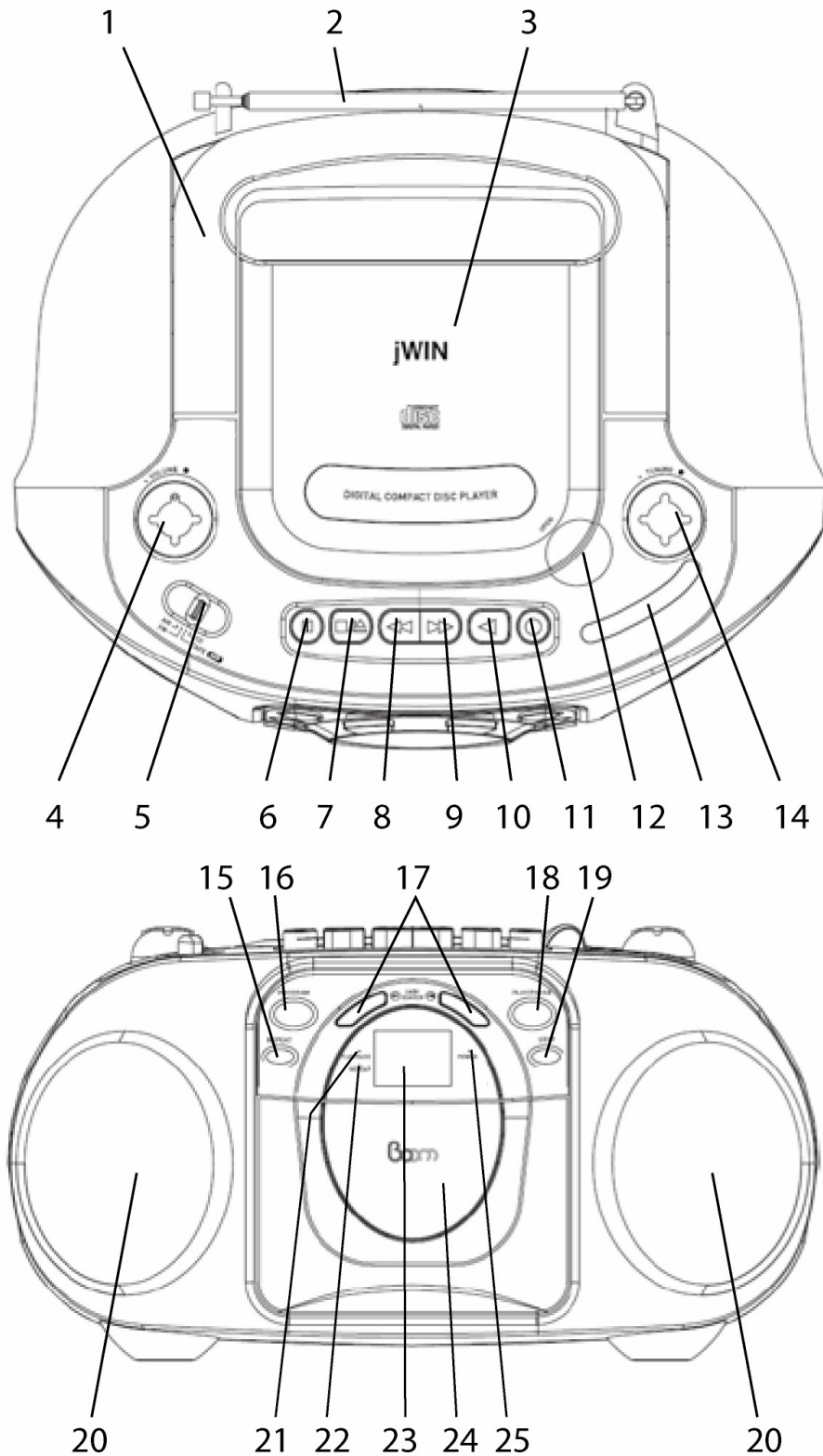

GETTING STARTED

Location of Controls-continued

- | | |
|---------------------------------|----------------------------|
| 1. HANDLE | 14. TUNING KNOB |
| 2. FM ANTENNA | 15. CD REPEAT BUTTON |
| 3. CD DOOR | 16. CD PROGRAM BUTTON |
| 4. VOLUME CONTROL KNOB | 17. CD SKIP/SEARCH BUTTON |
| 5. AM / FM / CD / TAPE SWITCH | 18. CD PLAY / PAUSE BUTTON |
| 6. CASSETTE PAUSE BUTTON | 19. CD STOP BUTTON |
| 7. CASSETTE STOP / EJECT BUTTON | 20. STEREO SPEAKERS |
| 8. CASSETTE FAST FORWARD BUTTON | 21. REPEAT INDICATOR |
| 9. CASSETTE REWIND BUTTON | 22. PLAY/PROGINDICATOR |
| 10. CASSETTE PLAY BUTTON | 23. LED SCREEN |
| 11. CASSETTE RECORD BUTTON | 24. CASSETTE DOOR |
| 12. CD DOOR OPEN BUTTON | 25. POWER INDICATOR |
| 13. TUNING READER | |

AC Operation

Before operating the JX-CD438, make sure that the voltage on the unit corresponds to the voltage of your local area. Unravel the AC Line Cord; insert one end into an AC socket on the unit and the other end into a standard AC outlet.

1. In case of malfunction due to electrostatic discharge (ESD), reset the unit by reconnecting the AC cord again to resume to normal operation.
2. When not in use, unplug the AC power cord from the AC power socket.

Battery Operation

Disconnect the AC Cord. Open the **BATTERY COMPARTMENT** and insert 8 x LR14 batteries (not included) making sure that the battery polarity (+/-) is observed.

Remove the batteries if the unit will not be used for a long period of time.

Note: The Power light will **ONLY** light up when the unit is connected through AC power, *not* when powered by batteries.

Antenna

For best FM reception, fully extend the **FM ANTENNA**. For AM reception, the unit has a built-in antenna, turn the whole unit for best reception.

OPERATING INSTRUCTIONS

Listening to the Radio

Slide the **FUNCTION SWITCH** to the **AM** or **FM** position. Turn the **TUNING KNOB** to your desired radio station. Adjust the sound level by rotating the **VOLUME CONTROL KNOB**. To turn off the radio, simply slide the **FUNCTION SWITCH** to **TAPE** position.

Note: Radio frequency is shown on the **TUNING READER**.

Listening to Cassettes

Slide the **FUNCTION SWITCH** to the **TAPE** position. Open the **CASSETTE DOOR** and place a cassette tape in the player. Use the Cassette Controls (**PLAY**, **PAUSE**, **F.FWD**, **REWIND**, **RECORD**, or **STOP**) to control the cassette playback. Adjust the sound level by rotating the **VOLUME CONTROL KNOB**.

Recording to Cassettes

The cassette player on the JX-CD438 has Automatic Level Control to automatically set the recording level for optimum performance.

RECORDING FROM THE RADIO

1. Slide the **FUNCTION SWITCH** to **AM** or **FM** and use the **TUNING KNOB** to find your desired radio station.
2. Open the **CASSETTE DOOR** and insert a recordable cassette tape.
3. Press the **CASSETTE RECORD** and **CASSETTE PLAY** buttons at the same time to begin recording from the selected radio station.
4. To stop recording, press the **CASSETTE STOP / EJECT** button.

RECORDING FROM A CD

1. Slide the **FUNCTION SWITCH** to **CD**.
2. Open the **CD DOOR** and insert a CD into the compartment.
3. Close the **CD DOOR**.
4. Press the **CD PLAY / PAUSE BUTTON** to begin CD playback.
5. Press the **CASSETTE RECORD** and **CASSETTE PLAY** buttons at the same time to begin recording from the CD.
6. To stop recording, press the **CASSETTE STOP / EJECT** button.

Listening to CDs

Open the **CD DOOR** by pressing the **CD OPEN BUTTON**. Place a CD disc into the **CD COMPARTMENT** and close the **CD DOOR**. Set the **FUNCTION SWITCH** to the **CD** position. Adjust the sound level by rotating the **VOLUME CONTROL KNOB**. Follow the Operational Instructions in the following pages of this manual.

Note: Before playing a CD make sure the **CD DOOR** is properly closed.

OPERATIONAL INSTRUCTIONS

Audio CD Playback

1. When the **CD DOOR** is closed and a CD is inside, the total number of the tracks in the disc show on the **LED SCREEN** and the **PLAY/PROG** indicator will light.
2. If there has no disc inside, the **LED SCREEN** will display "No" and remain in Stop mode.
3. If the **CD DOOR** is not closed, the **LED SCREEN** will display "00".

Total Track

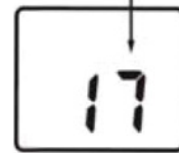

PLAY/PAUSE MODE

1. When the **PLAY/PAUSE** button is pressed during CD stop mode, the first track will play. The **PLAY/PROG** indicator will light. The **LED SCREEN** will also display the number of the currently playing track.
2. For interruption while the CD is playing, press the **CD PLAY/PAUSE** button once. Playback is now paused and the track number will blink continuously on the **LED SCREEN**.
3. Though the sound stops, the disc will continue to spin. To re-start playback, press the **PLAY/PAUSE** button again. The music will start from the exact position where it was interrupted.
4. To stop the CD, press the **STOP** button once in Play or Pause mode. The **LED SCREEN** will show the total number of tracks on the disc again.
5. To turn off the unit, slide the **FUNCTION SWITCH** to **TAPE/OFF** position.

First Track

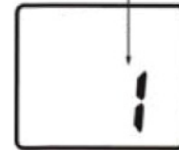

First Track

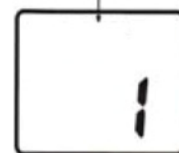

SKIP AND SEARCH MODE

1. In play or pause mode, when **CD SKIP/SEARCH** or **CD SKIP/SEARCH** button is pressed once, the player will advance to the next track or return to the beginning of the track.
2. During play mode, when **CD SKIP/SEARCH** or **CD SKIP/SEARCH** button is pressed and held, it will search the track with audible high-speed forward or backward playback.

OPERATIONAL INSTRUCTIONS

REPEAT MODE

1. Repeat 1:

When the **REPEAT** button is pressed once, the REPEAT indicator light will blink continuously. This single track of music will be repeated.



2. Repeat All:

When the **REPEAT** button is pressed twice, the REPEAT indicator light will light. The whole disc will be played continuously.



3. To cancel the Repeat Function

Press the **MODE** button repeatedly until the REPEAT Indicator light disappears.

PROGRAM MODE

1. During the CD stop mode, press the **PROGRAM** button once. The PLAY/PROG indicator light and the number of Program to be memorized starts from the first program "1" will blink continuously on the **LED SCREEN**.



2. Press the **CD SKIP/SEARCH** or **SKIP/SEARCH** button to your desired musical track, the **LCD SCREEN** will show the appropriate track number. Press the **PROGRAM** button to store this track in memory.

3. Repeat the above procedure until all desired tracks have been programmed. A total of 20 tracks can be stored in memory.

Note: When the **SKIP/SEARCH** button is pressed, it will always show the last programmed track first to recall your memory.

4. Press the **CD PLAY/PAUSE** button once to start the program playback and the CD play (PLAY/PROG) Indicator light will blink continuously

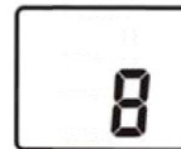

5. To check the program you have stored after complete programming, press the **PROGRAM** button once during CD stop mode, then press the **CD SKIP/SEARCH** **»»** button once, The **LCD SCREEN** will show the first programmed track number. Repeat above procedure to read all the programmed memory.



6. To cancel the programmed memory:

- During the CD stop mode, press the **CD STOP** button once, or
- Open the **CD DOOR** during the CD stop mode.

The PLAY/PROG Indicator light will disappear.

MAINTENANCE

Notes on CDs

1. Before playing, clean the CD with a cleaning cloth. Wipe the CD from the center out to the ends.
2. Do not use solvents such as benzine, thinner, commercially available cleaners or anti-static spray intended for vinyl LPs.
3. Do not expose the CD to direct sunlight or heat sources such as hot air ducts. Do not expose to direct sunlight, nor leave CDs in a car, as there can be a considerable rise in temperature.
4. Do not stick paper or sticker on the CD. Do not scratch, dirt or fingerprints on the CD, for it may cause tracking error.

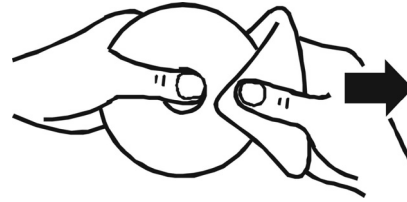

Cleaning the lens

If the lens becomes dirty, it may cause a skipping of sound during CD operation. Clean with a commercially available lens cleaner.

Cleaning the cabinet

Clean the cabinet, panel and controls with a soft cloth slightly moistened with a mild detergent solution. Do not use any type of abrasive pad, scouring powder, or solvent, such as alcohol or benzine.

TROUBLESHOOTING GUIDE

When the instructions in this manual are followed, this unit should function properly. However, if any of the following difficulties occur and cannot be corrected by the user or if a problem arises that is not mentioned here, please contact jWIN Customer Service or a qualified service technician.

1. Unit Does Not Play
 - Unit may be disconnected from power source (No AC connection or batteries). Check connection.
 - Disc is not correctly set. CDs should be inserted label side up.
 - Disc is scratched or dirty. Please clean.
 - The lens is dirty. Wipe clean gently with soft, dry cloth. Follow the instructions of the lens cleaner.
 - There is moisture on the lens wait an hour and try again.
2. No Sound, Distorted Sound or Feedback
 - Ensure plugs are inserted firmly.
 - Wipe off plugs with clean cloth.
 - Disc is scratched or dirty. Please clean.
 - Volume control is turned down. Please increase.
3. Radio Reception is Unclear
 - Radio station frequency may be weak. Adjust antenna.

SPECIFICATIONS

- Audio Output: $1.2W_{RMS}$ (L) + $1.2W_{RMS}$ (R)
 - Total: $2.4W_{RMS}$ / $4.8W_{PEAK}$ / $48W_{PMPO}$
- Frequency Range
 - AM: 530kHz – 1710kHz
 - FM: 88MHz – 108MHz
- Power Requirement
 - AC 110V, 60Hz
 - Battery: 12V (8 x “C” size or UM2 batteries, not included)
- Power Consumption: $\leq 15W$
- Unit Dimensions (W x H x D): 11.8” x 6.4” x 9.5” (300mm x 162mm x 240mm)
- Unit Weight: 5.32Lbs (2.4kg)

* Specifications and features are subject to change without prior notice.

jWIN

TEL: 516-626-7188

FAX: 516-626-7105

website: www.jWIN.com

© 2007 jWIN Electronics Corp. All rights reserved. No portion of this printed material or product enclosed herewith including design, shape and graphics, may be reproduced or transmitted in any form without prior written consent of jWIN Electronics Corp. by any means, electronic or mechanical, including photocopying, recording or use of an information storage and retrieval system. Any unauthorized distribution or reproduction of this printed material or product, or any portion thereof, will be prosecuted to the fullest possible extent of the law.

Printed in China

Free Manuals Download Website

<http://myh66.com>

<http://usermanuals.us>

<http://www.somanuals.com>

<http://www.4manuals.cc>

<http://www.manual-lib.com>

<http://www.404manual.com>

<http://www.luxmanual.com>

<http://aubethermostatmanual.com>

Golf course search by state

<http://golfingnear.com>

Email search by domain

<http://emailbydomain.com>

Auto manuals search

<http://auto.somanuals.com>

TV manuals search

<http://tv.somanuals.com>