

jWIN[®]

**MP3 PERSONAL COMPACT DISC PLAYER
WITH 45-SECOND DIGITAL
ANTI SKIP PROTECTION**

MODEL # JX-CD900

**BEFORE OPERATING THIS PRODUCT PLEASE
READ THESE INSTRUCTIONS COMPLETELY**

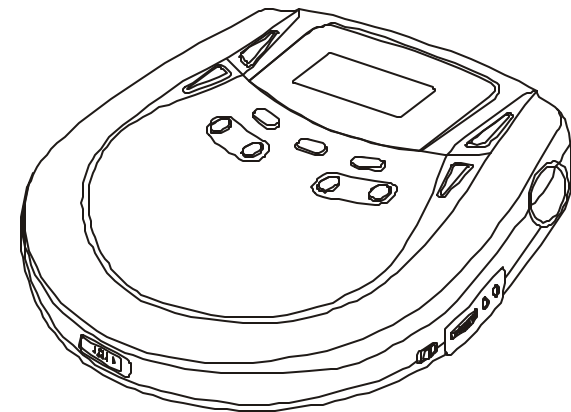

OPERATING INSTRUCTIONS

TABLE OF CONTENTS

WARNINGS AND PRECAUTIONS.....P. 1
 LOCATION OF CONTROLS.....P.2
 CONTROLS.....P.3
 POWER SUPPLY / LINE OUT.....P.4-P5
 HEADPHONES.....P.5
 MAINTENANCE.....P.6
 IN-CAR CONNECTION.....P.7
 CD PLAY.....P.8-P9
 FEATURES.....P.9-P.11
 MP3-CD PLAYBACK.....P.12-P.15
 TROUBLESHOOTING.....P.16-P.17
 LIMITED WARRANTY.....P.18

WARNINGS

TO REVENT FIRE OR SHOCK HAZARDS, DO NOT EXPOSE THIS UNIT TO RAIN OR MOISTURE.



This symbol is intended to alert the user to the presence of uninsulated " dangerous voltage " within the products enclosure that may be of sufficient magnitude to constitute a risk of electric shock to persons.



This symbol is intended to alert the user to the presence of important operating and maintenance (servicing) instructions in the literature accompanying the appliance.



This product utilizes a Class 1 laser to read Compact Discs. This laser Compact Disc Player is equipped with safety switches to avoid exposure when the CD door is open and the safety interlocks are defeated. Invisible laser radiation is present when the CD Player's lid is open and the system's interlock has failed or been defeated. It is very important that you avoid direct exposure to the laser beam at all times. Please do not attempt to defeat or bypass the safety switches.

Any use of the controls or an adjustment to the procedures other than those specified herein may result in hazardous radiation.

TO REDUCE THE RISK OF ELECTRIC SHOCK, DO NOT REMOVE COVER (OR BACK). THERE ARE NO USER-SERVICEABLE PARTS INSIDE. PLEASE REFER ANY SERVICING TO QUALIFIED SERVICE PERSONEL.

PRECAUTIONS

- Do not open the CD compartment while the CD is rotating.
- Always keep the CD compartment closed when not in use.
- Keep all foreign objects out of the CD compartment.
- If TV or radio interference occurs during operation, move the unit to a different location within the room or building.
- Place the unit on a stable surface. A vibration or shock to the unit can cause the CD mechanism to mistrack or skip. If operating the unit under circumstances, which may subject the unit to these conditions, utilize the digital Anti -shock.
- Playing some CD's at high volume can cause vibration leading to mistracking. In this case, lower the volume or relocate the speakers further away from the unit.
- Avoid installing the unit in the locations described below:
 - Where it will be in direct contact with water.
 - Where it will be in direct contact with a magnet.
 - Places exposed to direct sunlight or close to heat radiating appliances such as electric heaters
 - On top of stereo equipment that radiates too much heat.
 - Places lacking ventilation or dusty places.

- Places subject to constant vibration.
- Humid or moist places.

LOCATION OF CONTROLS

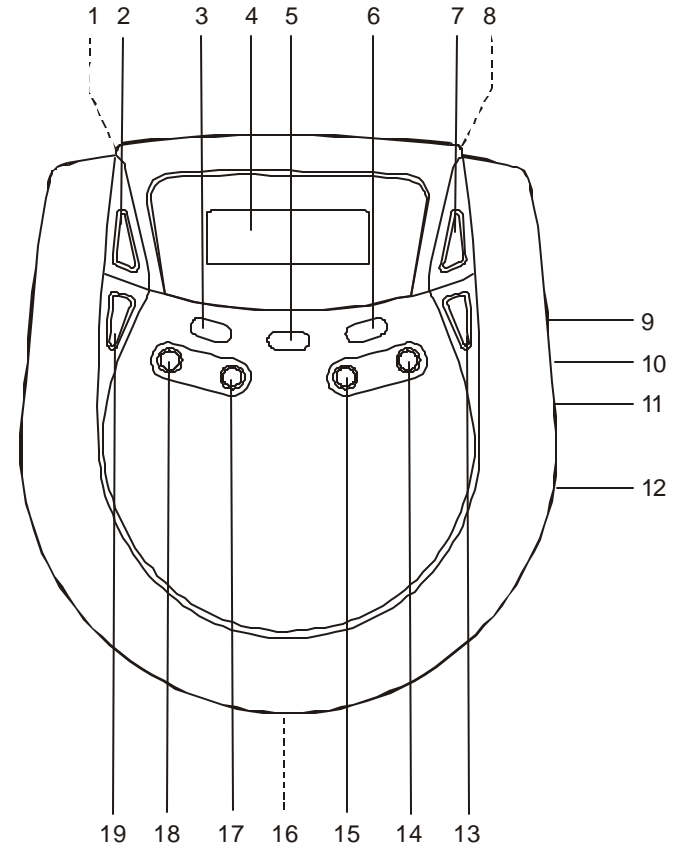

The player complies with the FCC-Rules, Part 15 and with 21 CFR 1040.10. Operation is subject to the following two conditions:
 1. This device may not cause harmful interference, and
 2. This device must accept any interference received, including interference that may cause undesired operation.

CONTROLS

Key Normal Mode No.	Key Operation	Search Mode
1. Battery compartment	Install Battery	
2. +SKIP/SEARCH	CD Audio: skips or fast search tracks forwards MP3: skips or search a previous track or album (AL)	3, G, H, I
3. PLAY MODE	Selects the different playing possibilities: RANDOM, INTRO, REPEAT ALL and REPEAT 1	5, M, N, O
4. Display Window	LCD Function Display	
5. PROGRAM	Enter program mode	6, P, Q, R, S
6. ESP	ELECTRONIC SKIP PROTECTION ensures continuous playback regardless of vibrations and shocks	7, T, U, V
7. PLAY/ PAUSE	Switches the set on, starts and interrupts CD play	1, A, B, C
8. DC INPUT JACK	Jack for 4.5V external power supply	
9. LINE OUT JACK	3.5mm line out jack to connect the set to an audio input of an additional appliance	
10. PHONE JACK	3.5mm headphone and remote control jack	
11. VOLUME	Adjusts the volume	
12. DBBS SWITCH	DYNAMIC BASS BOOST switches the bass enhancement on/off	
13. STOP	Stops CD play, eases a program and switches the set off	2, D, E, F
14. FILE SEARCH	MP-3 File Search	"Enter"
15. DISPLAY	MP-3 Display Select	0, "clear"
16. OPEN SWITCH	Opens the CD lid	
17. FILE/DIR.	MP-3 Select	9, "Space"
18. RESUME	CD Audio: stores and continues playback from the last track MP3: stores and continues playback from the last track played	8, W, X, Y, Z
19. -SKIP/ SEARCH	CD Audio: skips or fast search tracks backwards MP3: skips or search a next track or album (AL)	4, J, K, L

CAUTION
Use of controls or adjustments or performance of procedures other than herein may result in hazardous radiation exposure.

POWER SUPPLY

Batteries (not included)

With this set you can use:

- Alkaline batteries (type LR6, UM3 or AA)

Inserting batteries

1. Open the battery compartment and insert 2 alkaline batteries. Follow the polarity as indicated in the battery compartment.

- Notes:
- Old and new or different types of batteries should not be used in combination.
 - Remove batteries if they are empty or if the Set will not be used for a long time.



Batteries contain chemical substances, so they should be disposed of properly.

Indication of empty batteries

- A flashing "LOW BATTERY" indication appears on the display when the battery need to be changed. Replace the batteries or connect the power adapter.



Notes: The average playing time of batteries under normal condition.

Battery type	ESP on	ESP off
CD Normal	3 hours	4 hours
CD Alkaline	6 hours	7 hours
MP3 Normal	4 hours	N/A
MP3 Alkaline	10 hours	N/A

POWER SUPPLY/LINE OUT

Power adapter (supplied or optionally available)

Only use the 4.5V/600mA direct current, positive pole to center pin power adapter. Any other adapter may damage the set.

- 1 Make sure the local voltage corresponds to the adapter's voltage.
- 2 Connect the power adapter to the 4.5V DC jack of the player and to the wall outlet.

Note: Always disconnect the adapter when you are not using it.

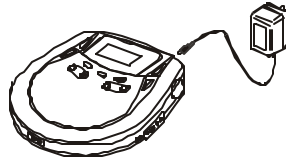

Line out

You can connect the CD player to an additional appliance. E.g. amplifier, radio cassette recorder, etc., with a LINE IN jack.

- 1 Turn down the volume on the additional appliance.
- 2 Connect an audio signal cable (not supplied,) to the LINE OUT jack of the CD player and the CD IN, AUX IN or LINE IN jack of the additional appliance.
- 3 To adjust the sound and volume, use the controls on the connected appliance.

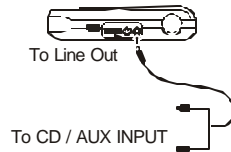

HEADPHONES

Connecting the headphone

- Connect the supplied headphones into the PHONE (GREEN) socket.

Use your head when using headphones

- Hearing safety: Do not play your headset at a high volume. Hearing experts advise against continuous extended play. If you experience a ringing in your ears, reduce the volume or discontinue use.
- Traffic safety: Don not use while operating a motorized vehicle. It may create a traffic hazard and it's illegal in many areas. You should use extreme caution or temporarily discontinue use in potentially hazardous situations. Even if your headset is an open-air type designed to let you hear outside sounds, don't turn up the volume so high that you can't hear what's around you.

CD player and CD handling

- Do not touch the lens of the player.
- Do not expose the set, batteries or CDs to humidity, rain, sand or excessive heat (caused by heating equipment or direct sunlight).
- You can clean the CD player with a soft, slightly dampened lint-free cloth. Do not use any cleaning agents as they may have a corrosive effect.
- To clean the CD, wipe it in a straight line from the center toward the edge using a soft, lint-free cloth. A cleaning agent may damage the disc! Never write on a CD or attach a sticker to it.
- The lens may cloud over when the set is moved suddenly from cold to warm surroundings. Playing a CD is not possible then. Leave the CD player in a warm environment until the moisture evaporates.
- Active mobile phones in the vicinity of the CD player may cause malfunctions.
- Avoid dropping the set as this may cause damage.

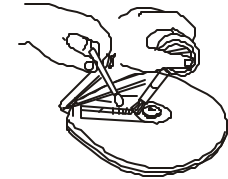

Environmental information

- All redundant packing material has been omitted. We have done our utmost to make the packaging easily separable into three materials: cardboard (box), polystyrene foam (buffer) and polyethylene (bags, protective foam sheet).
- Your set consists of materials, which can be recycled if disassembled by a specialized company. Please observe the local regulations regarding the disposal of packing materials, dead batteries and old equipment.

IN-CAR CONNECTION

In-car use (connections supplied or optionally available)

Only use the car voltage converter (4.5V, DC, positive pole to the center pin) and the car adapter cassette. Any other product may damage the set.

- 1 Put the CD player on a horizontal, vibration-free and stable surface. Make sure it is a safe place, where the player is not a danger or obstacle to the driver and passengers.
- 2 Connect the DC plug of the voltage converter to the 4.5V DC jack of the CD player (**only for a 12V car battery, negative grounding**).

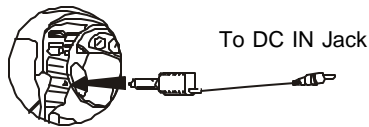

- 3 Insert the voltage converter into the cigarette lighter jack. If necessary, clean the cigarette lighter jack to obtain a good electrical contact.
- 4 Turn down the volume and connect the adapter cassette plug to the LINE OUT of the CD player.
- 5 Carefully insert the adapter cassette into the car radio's cassette compartment.

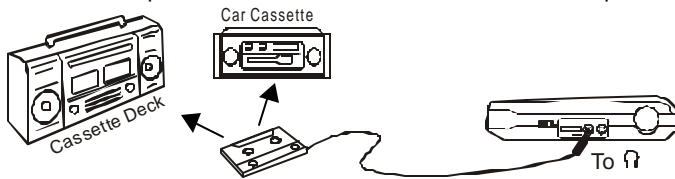

- 6 Make sure the cord does not hinder your driving.
 - 7 Start the CD player, set VOL to the lower position and adjust the sound with the car radio controls.
- Always remove the voltage converter from the cigarette lighter jack when the CD player is not in use.

Notes:

- Avoid excessive heat from the car heating or from direct sunlight (e.g. in a parked car in the summer).
- If your car radio has a LINE IN jack, use the LINE IN jack for the car radio connection instead of the adapter cassette. Connect the signal lead to this LINE IN jack and the LINE OUT jack of the CD player.

CD PLAY

Playing a CD

This CD player can play all kinds of **Audio Discs** and MP3 CD-ROM such as CD Recordables and CD Rewritables. Do not try to play a Cdi, CDV or computer CD or DVD.

- 1 Push the OPEN slider and the lid opens. The "Door Open" indicator will appear in LCD.
- 2 Insert an audio CD, printed side up, by pressing gently on the CD center so that it fits onto the hub. Close the lid by pressing it down on the left side.
- 3 Press PLAY/PAUSE button for approximately 1 second to switch the set on and start playback. The current track number and the elapsed playing time are displayed. It will take approx. 5 seconds for a CD to begin playback.

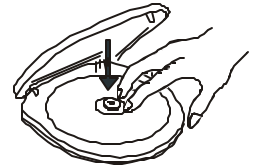
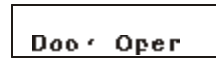

- You can interrupt playback by pressing PLAY/PAUSE button.

The time where playback was interrupted is flashing.

- Continue playback by pressing PLAY/PAUSE button again.



- 4 Press STOP button to stop playback. The total number of tracks and the total playing time of the CD are displayed.
- 5 Press STOP button again to switch off the set.
- 6 To remove the CD, hold it by its edge and press the hub gently while lifting the CD.

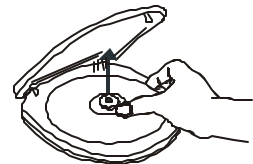

- When the unit is turned on, the "ESP" function is automatically turned on, and shown on display "ESP". If ESP function is not required, please press ESP button to turn it off.

CD PLAY

Playback information

- If a CD Rewritable (CD Recordable) is not recorded properly. "Disc Error" is displayed.
For CD Audio, use FINALIZE on your CD recorder to complete the recording.
- Playback will stop if you open the CD lid.
- While the CD is read, "ESP" flashes.
- If there is no activity for 10 seconds, the set will clear the display, and if there is no activity after another 50 seconds, the set will switch off automatically to save energy. Any settings like program and playing modes will be then lost.

Volume and sound adjustment

- Adjust the volume by using VOLUME control .



DBBS – Dynamic bass boost System

- Switch the DBBS slider to ON position to activate the DBB sound.



Note: The DBB sound option is only activated in the Headphone mode.

FEATURES

Selecting a track and searching

Selecting a track during playback

- Briefly press +SKIP / SEARCH or -SKIP / SEARCH button once or several times to skip to the current, previous or subsequent track start. Playback continues with the selected track and its number is displayed.

Selecting a track when playback is stopped

- 1 Briefly press +SKIP / SEARCH or -SKIP / SEARCH button once or several times. The selected track number is displayed.
- 2 Press PLAY / PAUSE button to start CD play. The play back starts with the selected track.

Searching for a passage during playback

- 1 Keep +SKIP / SEARCH or -SKIP / SEARCH button to find a particular passage in a backward or forward direction. Search is started and playback continues at a low volume. After 2 seconds the search speeds up.

- 2 Release the button when you reach the desired passage. Normal playback continues from this very position.

Note: - During SCAN, searching is not possible.

FEATURES

Programming track numbers

You can select up to 24 tracks and store them in the memory in a desired sequence. You can store any track more than once.

- 1 While playback is stopped, press PROGRAM to store the track.
PROGRAM "P" lights up, the track number programmed and the total number of stored tracks are displayed.

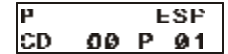

- 2 Select a track by directly entering track number. (Example press "1" and "3" to program track 13).
* Press ENTER button once after each track number have desired.

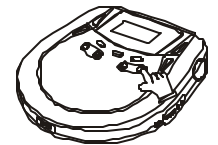

- 3 Select and store all desired tracks in this way.
* Press one more ENTER button to select the programming.

- 4 Press PLAY button to start playback of your selected tracks.
 - You can review the program by pressing SKIP button when playback is stopped. The display shows all stored tracks in sequence.



Note: - If you press PROGRAM and there is no track selected, after 10 sec. It will go back to Normal position.

Erasing the program

If necessary, press STOP button to stop playback.

- Note: The program will also be erased if you
- interrupt the power supply,
 - open the CD lid, or
 - the set is switched off automatically.

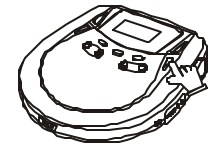

ESP

With a conventional portable CD player, you might have experienced that the music stopped e.g. when jogging. The **ELECTRONIC SKIP PROTECTION** protects against loss of sound caused by vibrations and shocks. Continuous playback is ensured. However, it does not protect the set against any **damage** caused **by dropping!**

Note: When playing MP3 tracks, the display will read "Welcome MP3", and the ESP feature will not appear but will automatically be activated, regardless of the ESP switch setting.

FEATURES

Selecting different playing options – MODE

It is possible to play tracks in random order, to repeat a track or the CD and to play the first few seconds of each track.

1 Press play MODE during playback as often as necessary until the display shows either:

- **REPEAT 1** : The current track is played repeatedly. "REP 1" is displayed.

REP 1 ESP
CD 01 02:00

- **REPEAT ALL**: The entire CD is played repeatedly. "REP A" is displayed.

REP A ESP
CD 01 02:00

- **REPEAT "D"**: The current directory file is played repeatedly. "REP D" is displayed.

REP D ESP
21 021 03:01

- **"Intro"**: The first 10 seconds of each of the remaining tracks are played in sequence. "INT" is displayed.

INT ESP
CD 01 02:00

- **RANDOM**: All tracks of the CD are played in random order until all of them have been played once. "RND" is displayed.

RND ESP
CD 01 02:00

- Repeat Directory all songs within a directory are played repeatedly in order (MP3 only).

2 Press play in selected mode to begin.

3 To return to normal playback, press play MODE until the mode feature display indication disappears.



MP3-CD PLAYBACK

To play MP3-CDs

IMPORTANT INFORMATION

- Use mp3 as the extension to save audio files onto CD-R(W) or CD ROM, e.g. mp3. Do not use any other extensions e.g. doc, txt, pdf, etc., when making audio files into MP3.
- Do not use the .mp3 extension for text or other non-audio data files. This may result in serious malfunction of the set and harmful noise interference.
- Single session means only one session created in the CD-ROM.
- **File Directory**: this is the set's display abbreviation for "album or folder". On a PC display, an album is shown as **Folder** in Window Explorer.
- **Do not attempt to combine CD audio and MP3 tracks within a CDROM, as the set will only be able to playback your CD audio tracks from mixed CD formats.**

1 Place a MP3 CD-ROM with the label side up. Push the CD center lightly to set it in position.

2 Press STOP button to stop playback. Playback stops and the display shows the total number of tracks and total number of directory's.

Selecting and searching a track/album

The following table shows the different function available for the controls when playing CD Audio or MP3 CDs.

- **Single file** is the set's display for a MP3 CD with only a root directory. This has no additional albums (folders).
- **With albums** means a MP3 CD with more than one album (folders), and is shown by directory and a number on the set's display, e.g. AL 09.

Function	CD audio	MP3	MP3 (with multiple Files)
Select track			
Music search			
Fast track select			
Fast album select			

MP3-CD PLAYBACK

Select track

To select the next or previous track.

- Press the +SKIP / SEARCH button or -SKIP / SEARCH button briefly once or more during playback.
Playback is interrupted and starts from the beginning of the selected track.

Music search

To fast search only within a CD Audio track.

- During playback, press and hold down the +SKIP / SEARCH button or -SKIP / SEARCH button. Release button at the desired passage.

Fast track select

In the stop position, you can select tracks from your directory. The display will show the total number of tracks, and directory's.

- 1 Press the FILE / DIR. button once, the track number is flashing.
- 2 Press the ENTER button.
- 3 Press track number button / E.g. Track 160; press "1", "6", "0".
- 4 Press the ENTER button to start playback.

Fast album select

In the stop position, you can select an album if your root directory holds more than one directory.

The display will show the total number of tracks, and the total number of albums.

- 1 Press the FILE / DIR. button two times, the directory number is flashing.
- 2 Press the ENTER button
- 3 Press Album no. (e.g. Album 12, press "1" and "2" then press enter).
- 4 The track will automatically play.

MP3-CD PLAYBACK

Album (selecting songs name "Funny") **Max. enter 6 letter** 67 songs

- 1 Press the FILE SEARCH button one time will show (file name?)
- 2 Press the F button than press the enter button, and press U button
... NNY ...
- 3 Press the ENTER button two times will auto playback.
- 4 Or press only letter "F" than ENTER button two times and press PLAY button.
(Flashes mean more than two of "F" letter songs.

Note : Any mp3 files , i.e. title containing symbols (examples: *, / , (,) , = etc.) are not recognized and there cannot be used for search purposes.
File name contain spaces (example John Harper.mp3) can be searched by inputting in the space. However, of the files is actually johnharper.mp3 do not use any spaces when input for search.
(Tip) : in case of spaces inputting with three letters or less will avoid the space issue.

Dir search (must be more than 2 file)

- 1 Press the FILE SEARCH button two time will show (Dir. Name)
- 2 Press the MP3 file name exp. CD02 Press C enter D enter two time will auto playback.

Programming track numbers

- 1 Press the STOP button than press PROGRAM Button (will show display "P") select the file no. enter. Than select the track no. press the ENTER button. Will change to Prog. 2 (total 24 track prog.) If press the ENTER button 2 time than press the PLAY button will auto playback.
- 2 Press the STOP button will return to TOC.
- 3 Press the PROGRAM button again and press the PLAY button will playback before memory Prog.
- 4 Check the Prog. no. Press the SKIP button will show the Prog. no.

Note: If you make an error while searching or programming hold the CLEAR button for 2 seconds to return to main "welcome MP3" display.

MP3-CD PLAYBACK

Single session

The following chart is an example of a **Windows Explorer** display for a single session MP3 CD ROM with albums. Check the added Notes to help you understand the MP3 CD unit display, and the playback sequence of albums and tracks on single session MP3 CDs.

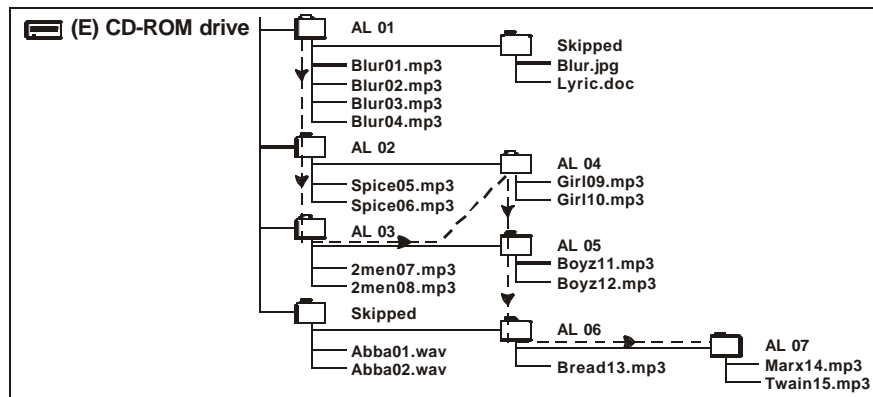

Notes: - ➔ Arrow pathway show the sequence of MP3 album and track playback.

AL01-AL07 This CD ROM example has a total number of 7 MP3 albums (folders).

Blur01.mp3-Twain15.mp3 This CD ROM example has a total number of 15 tracks, where '01' is the first track and '15' is the last track.

Skipped Denotes an album which contains non-audio files only, e.g. jpg, wav., doc. These cannot be detected nor played on the MP3-CD player, and are hence 'skipped'. Where an album contains mixed format files, the non-MP3 files will be skipped.

MP3 Properties	Standard
MPEG rate	32 ~ 128Kbps
Sampling Frequency	44.1KHz
MPEG 1	Layer 3
MP3 playback	ISO9660 format compatible

Software Properties section of your computer will have this confirmation.

TROUBLESHOOTING

WARNING

Under no circumstances should you try to repair the set yourself as this will invalidate the warranty.

If a fault occurs, first check the points listed, before taking the set of repair.

If you are unable to solve a problem by following these hints, consult your dealer or service center.

Symptom	Check point	Treatment
Power cannot be turned on	Batteries Are the batteries inserted correctly?	Insert batteries in correctly.
	Are the batteries dead?	Replace batteries.
	Power adapter Loose connection?	Connect the adapter securely
	Is the power adapter connected properly?	Connect the power adapter properly.
In-car use	Cigarette lighter is not powered when ignition is off?	Switch on ignition or insert batteries.
	Is the cigarette lighter power on?	Switch on ignition or insert batteries.
Playback is impossible or stops during playback CD	Is the disc cover closed properly?	Close the disc cover tightly.
	Is there condensation on the lens?	Wait until the lens has cleared.
	Is the CD inserted properly?	Place the CD with the label side up.
	Is the CD scratched or damaged?	Use another CD.
If using an MP3 CD burned from a computer, there could have been a transfer error in the process. This is an error between modem and computer or computer and CD. This is not an error with the Memorex Discman.		

Note: If you make an error while programming or searching hold the "clear" button for 2 seconds to return to main "welcome MP3" Display.

TROUBLESHOOTING

Symptom	Check point	Treatment
Playback does not start from not start from first track	Is the RESUME or PROGRAM function activated?	Switch off the RESUME function or clear the PROGRAM.
No sound or poor sound quality	Are connection plugs inserted properly?	Check all connections.
	Is the volume set too low?	Adjust the volume.
	Is the headphone plug dirty?	Clean the headphone plug.
	Is the set located near strong magnetic fields?	Move the set away from strong magnetized fields.
	In-car use	
	Adapter cassette is inserted incorrectly?	Insert the adapter cassette correctly.
	Is the adapter cassette inserted properly?	Insert the adapter cassette correctly.
	Is the temperature inside car too high/low?	Let the set adjust to the temperature.
Is the cigarette lighter socket dirty?	Clean the cigarette light socket.	
Is the playback direction of car cassette player's auto-reverse feature?	Change the auto reverse direction.	

The typeplate is located on the bottom of the set.

Note: If you find an error and the disc is not reading properly simply power-off the unit completely, wait 5 seconds, and re-power, turn on, the unit.

Free Manuals Download Website

<http://myh66.com>

<http://usermanuals.us>

<http://www.somanuals.com>

<http://www.4manuals.cc>

<http://www.manual-lib.com>

<http://www.404manual.com>

<http://www.luxmanual.com>

<http://aubethermostatmanual.com>

Golf course search by state

<http://golfingnear.com>

Email search by domain

<http://emailbydomain.com>

Auto manuals search

<http://auto.somanuals.com>

TV manuals search

<http://tv.somanuals.com>