

jWIN[®]

5.5" BLACK & WHITE SECURITY MONITOR WITH CAMERA



TABLE OF CONTENTS

Introduction	3
Caution	3
Out of the Box	4
Front View	5
Rear View	6
Camera View	6
Putting it all together	7
Basic Operations.....	8
Set Up for Alternative Audio/Video Connections.....	10
Set Up for VCR Connection	12
Technical Data/Specifications.....	13

INTRODUCTION

Congratulations on your purchase of the JV-TV2040 and thank you for choosing jWIN®. The jWIN® monitor with camera has a variety of features that make it an exceptional quality security system for stores, banks, hotels, schools, factories, apartments, with many applications. In addition to the basic operations, it provides a variety of special features designed to increase the effectiveness and ease of providing security.

This manual gives you easy-to-follow instructions for installing and using the JV-TV2040. The Table of Contents will show you where to find instructions for using each feature. While you may not need to read every section in detail at first, we recommend you at least look them over briefly and that you save this manual for future reference.



CAUTION

To extend the life of your new equipment and to assure the finest performance, please adhere to the following cautions.

- Be sure to disconnect the power supply to the television or monitor when connecting the camera.
- Do not expose the components of this kit to extreme heat, ultraviolet light, or moisture.
- Protect the contents from rain and direct sunlight.
- Periodically check the cables to be sure they are properly and securely connected.
- Employ only authorized technicians to service this unit.

OUT OF THE BOX

After unpacking, make sure you have all the items shown below. If any are missing, contact your dealer or retailer.

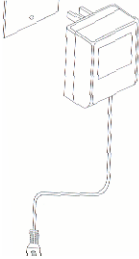
Component	Diagram	Features
<ul style="list-style-type: none"> ▪ 5.5" black & white monitor 		<ul style="list-style-type: none"> • High resolution • Brightness and contrast controls • Two channels (for two cameras) • Single camera capability • Compatibility with a variety of camera, video and audio outputs • Built in two camera auto switch
<ul style="list-style-type: none"> ▪ Weather resistant camera with lens cover (and two screws to secure camera placement) 		<ul style="list-style-type: none"> • High resolution and sensitivity • Low energy consumption and excellent stabilization • Adjustable lens • Infrared lights that enable clear viewing at night • DIN connector • Built in microphone
<ul style="list-style-type: none"> ▪ 60' cable with DIN plug 		<ul style="list-style-type: none"> • High quality cable with DIN connector and sufficient length to facilitate monitoring from a distance.
<ul style="list-style-type: none"> ▪ AC Adapter/Power Cord 		<ul style="list-style-type: none"> • UL listed power supply • 15V 1200mA DC power supply

FRONT VIEW

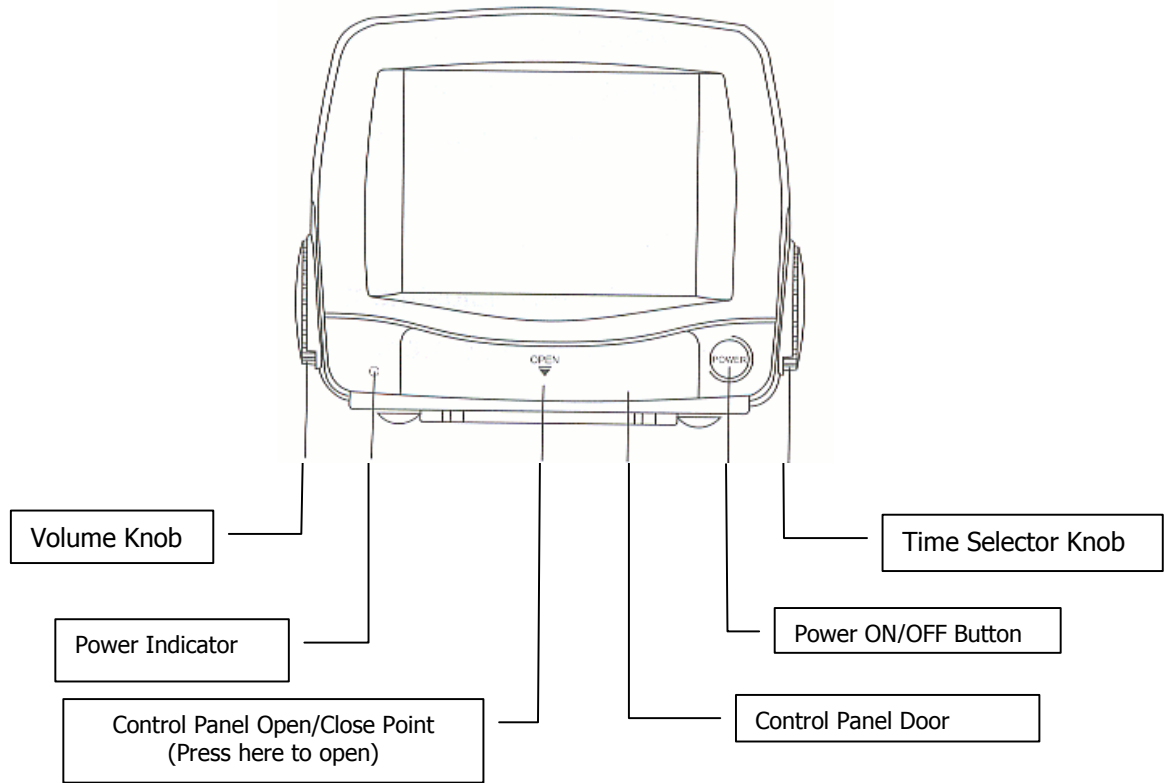

With the control panel open, the following items are in view:

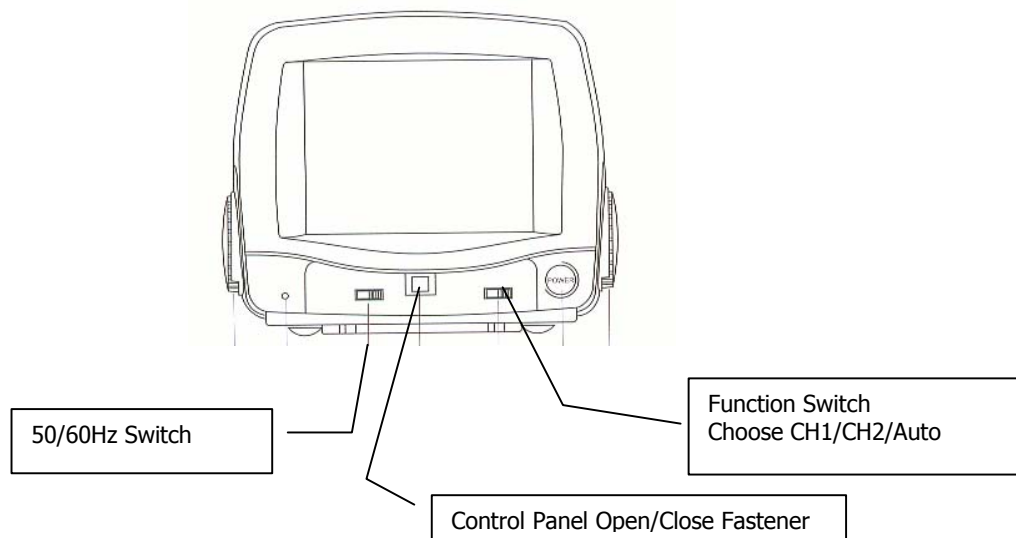

REAR VIEW

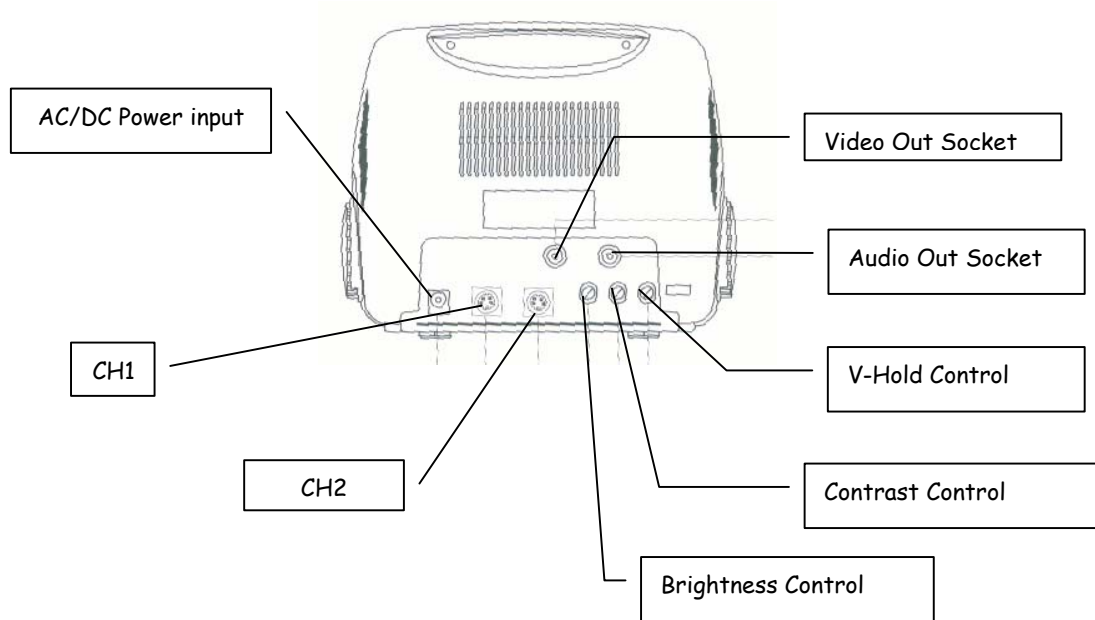

CAMERA VIEW

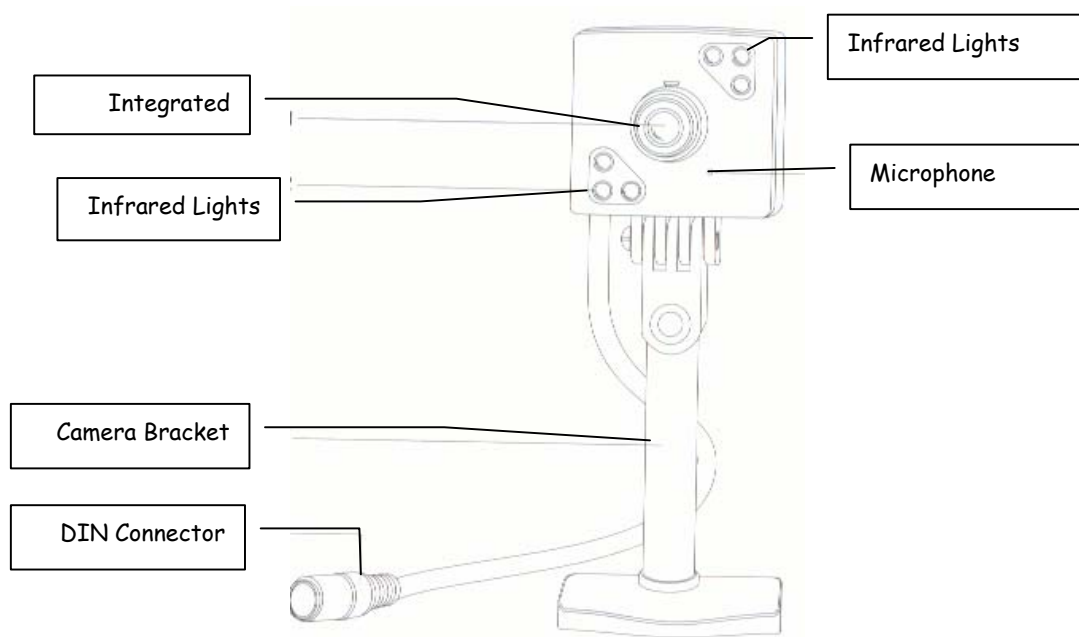

PUTTING IT ALL TOGETHER

You will be pleased with the ease of installation of this unit. With just a few quick steps, your unit will be up and running in a very short period of time.

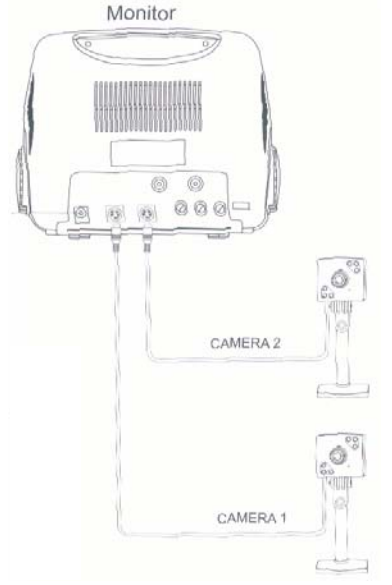
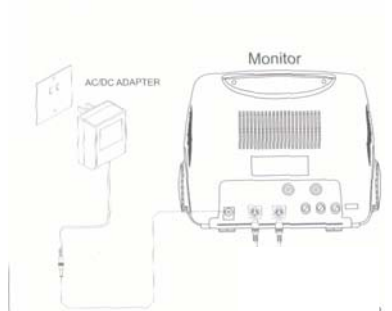
<p>1. Connect the camera to the monitor.</p> <p>Be sure that the power cable is not connected.</p> <p>a. Connect one end of the 60' cable to the camera cable and connect the other end to the Channel (CH) port on the back of the monitor as follows:</p> <ul style="list-style-type: none">▪ If you are using only 1 camera: connect the 60' cable to the CH1 port on the back of the monitor.▪ If you are using 2 cameras: connect the first 60' cable to the CH1 port on the back of the monitor and then connect the second cable to the CH2 port.	
<p>2. Connect the power cable:</p> <p>a. Attach one end to the power connector port on the left side of the rear of the monitor.</p> <p>b. Plug the AC/DC adapter into an electrical outlet.</p>	

That's all there is to set up! You are now ready to start your unit and adjust the monitor image and sound.

BASIC OPERATIONS

These simple steps will enable you to get the best quality sound and image on your closed circuit monitor.

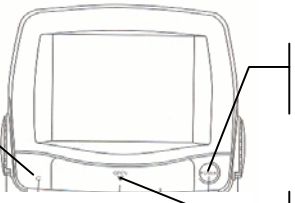
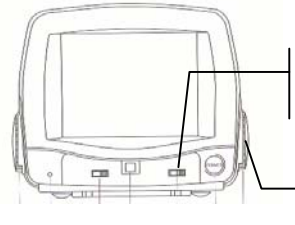
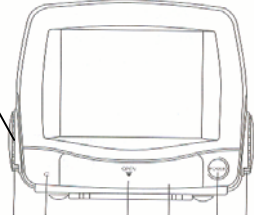
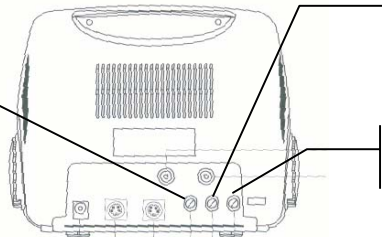
<p>1. Push the power ON/OFF button. The power indicator light comes on.</p> <p>Power Indicator Light</p>	 <p>Power ON/OFF Button</p> <p>Control Panel Door</p>
<p>2. Open the control panel.</p> <p>3. Move the function switch to position “CH1” or “CH2” or Auto.</p> <p><i>Note:</i></p> <ul style="list-style-type: none">■ Use CH1 or CH2 when using only 1 camera.■ Use Auto when you want to use 2 cameras and switch views according to your time setting.■ Select the auto switching time.■ Don't forget to remove the camera lens cover.	 <p>CH1/CH2/AUTO switch</p> <p>Time Selector</p>
<p>4. Set the volume</p> <ul style="list-style-type: none">■ To increase volume, turn the volume knob (found on the left side of the unit) toward you.■ To decrease volume, turn the volume knob away from you.	 <p>Volume Control</p>
<p>5. Adjust brightness, contrast, and V-Hold to improve the image.</p> <p>Brightness Control</p>	 <p>Contrast Control</p> <p>V-Hold Control</p>

VOLUME ADJUSTMENT

The jWIN Security Camera has a built-in microphone that delivers high quality sound. You can adjust the sound from your monitor.

To increase volume:

- Turn the volume knob (found on the left side of the unit) toward you.

To decrease volume:

- Turn the volume knob away from you.

Volume Control

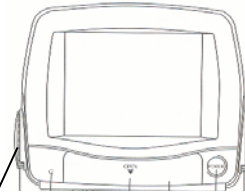

TIME ADJUSTMENT

If you are using two cameras, you will want to adjust the timer to switch or cycle from one view to another every few seconds.

The Time Control knob is located on the right side of the TV Monitor when you are facing the screen. When you look at the knob, you will see that it is marked from 2 seconds to 20 seconds in increments.

Use the knob to indicate when you want to switch views from one camera to another.

To increase the time setting:

- While facing the monitor screen turn the Time Control knob away from you.

To decrease the time setting:

- Turn the Time Control knob toward you.

Time Control

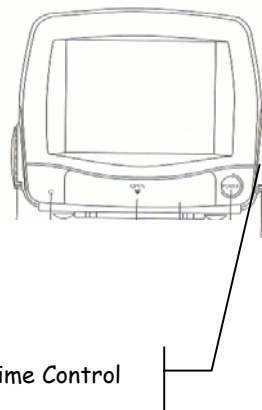

SET UP FOR ALTERNATIVE AUDIO/VIDEO CONNECTIONS

The adaptability of the JV-TV2040 enables a variety of set-up possibilities. The diagram below shows how you can connect a single input/camera to several output stations. From this example, you can determine the set up that best meets your needs.

Note:

The signal from the Audio/Video Out socket is consistent with that of the monitor. The output can be connected to another monitor for viewing or to a VCR for recording.

Consistent with the input video signal, please change the 50/60 Hz switch (front control panel) to the correct position.

ONE CHANNEL INPUT CONNECTION

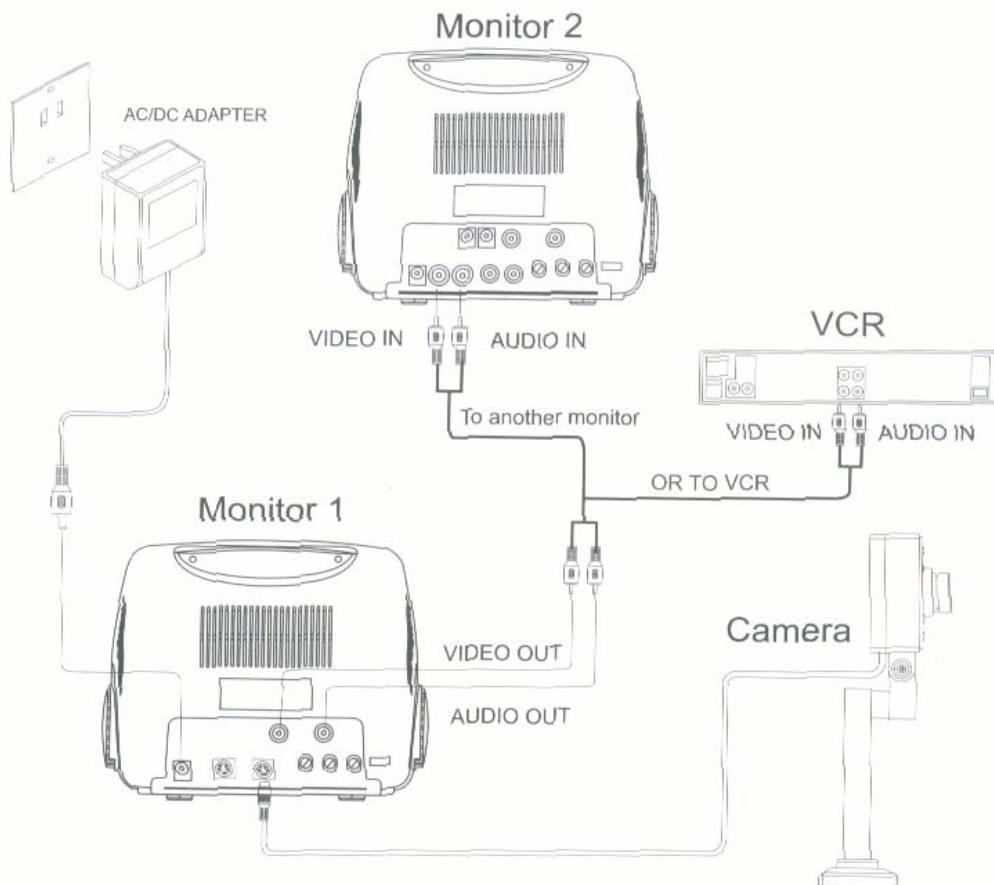

TWO CHANNEL INPUT CONNECTION

If you wish to use two cameras and observe both views on one monitor, the following set up will suit your purposes.

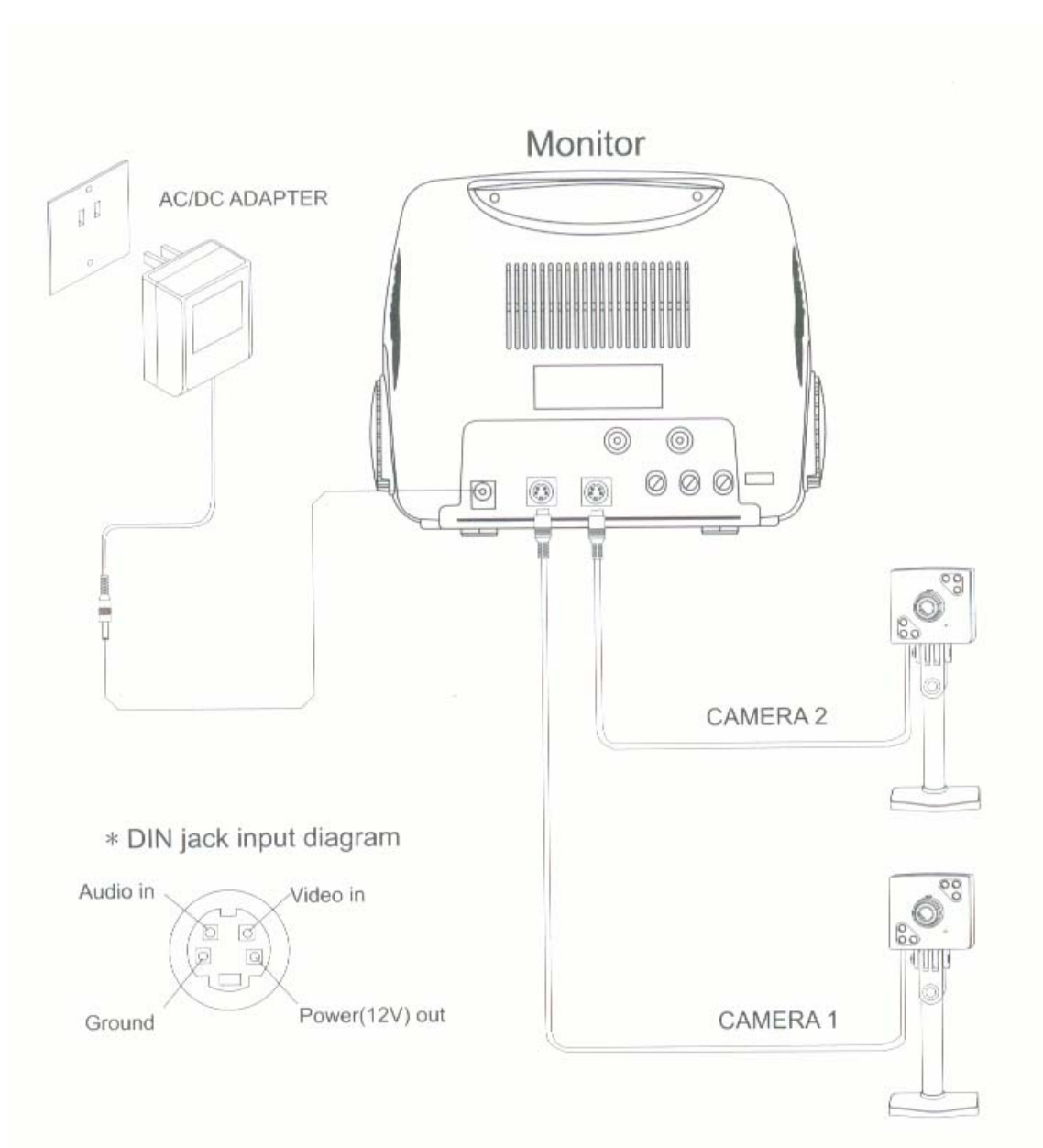

SET UP FOR VCR CONNECTION

You can use a VCR to record the images captured by your CCTV, the following set up will enable you to do this.

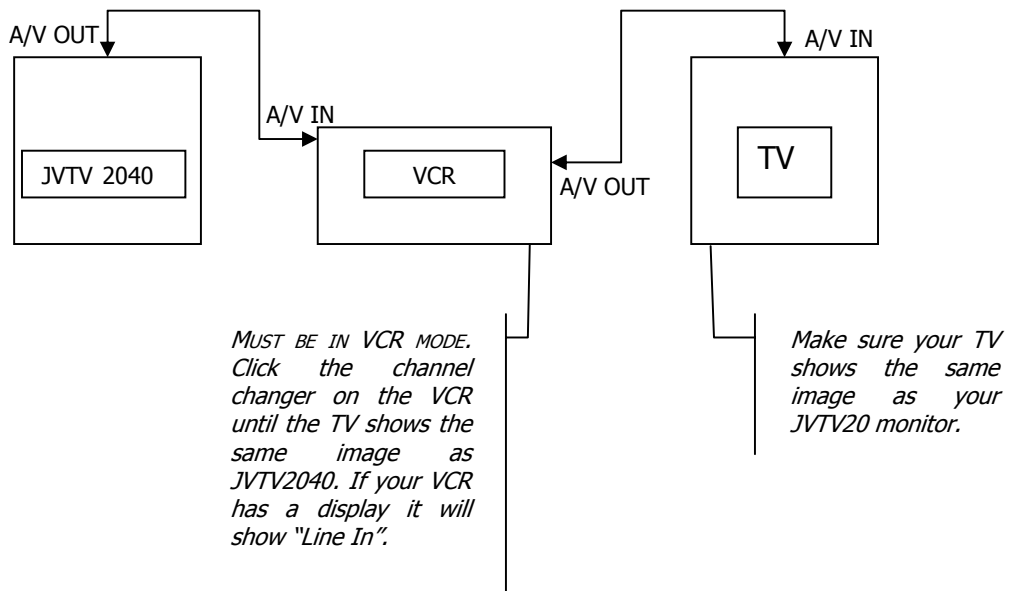

TECHNICAL DATA/SPECIFICATIONS

Weight: 6.3 lbs
Mass: 10.6"x9.3"x8.6"

Monitor

Power: DC15V 1200mA

Power consumption: <20W

Camera

Resolution: 380 Horizontal TV Lines

Signal Noise Ratio: <48dB

Min Illumination: 0.5LUX

Integrated Lens: 3.6mm View Range: 78

Voltage: 12V/80mA

System: EIA

Audio Function: Audio Out

Free Manuals Download Website

<http://myh66.com>

<http://usermanuals.us>

<http://www.somanuals.com>

<http://www.4manuals.cc>

<http://www.manual-lib.com>

<http://www.404manual.com>

<http://www.luxmanual.com>

<http://aubethermostatmanual.com>

Golf course search by state

<http://golfingnear.com>

Email search by domain

<http://emailbydomain.com>

Auto manuals search

<http://auto.somanuals.com>

TV manuals search

<http://tv.somanuals.com>