

# jWIN

## Caller ID Speaker Phone



### Instruction Manual

JT-P531

Please read this manual carefully before operating and save it for future reference.

Have a question? Please visit <http://www.jWIN.com>

Download from [Www.Somanuals.com](http://www.Somanuals.com). All Manuals Search And Download.



## USER SAFETY GUIDE

### INSTRUCTIONS ON ENVIRONMENT PROTECTION

Do not dispose of this product in the usual household garbage at the end of its life cycle; bring it to a collection point for the recycling of electrical and electronic appliances. This symbol on the product means the instructions for use or the packaging will inform about the methods of disposal. The materials are recyclable as mentioned in its marking. By recycling, material recycling, and other forms of re-utilization of old appliances, you make an important contribution to the protection of the environment. Please inquire at your local community administration for an authorized disposal location.



### Important Safety Instructions

When used as directed, this unit has been designed and manufactured to ensure your personal safety. However, improper use may result in electric shock, fire hazards or other dangers. Please read all safety and operating instructions carefully before installation and use. Remember to keep this instruction manual handy for future reference. Take special note of all warnings contained in these instructions and on the unit itself.

- Read and follow all instructions in this manual.
- Unplug this telephone from wall jack before cleaning with a damp cloth.
- Do not use liquid or aerosol cleansers to clean this product.
- Do not use this telephone in or near water (e.g. a bath tub, a sink, or a pool).
- To reduce the risk of electric shock, do not push objects through any slots of the phone or disassemble the telephone. Pushing objects into the telephone or opening (or removing) covers exposes wires and poses serious risks.
- Do not disassemble and/or reassemble this telephone yourself. Contact technical support when service is required.
- Do not place this telephone on a bed, rug, or on any similar surface or near a heat source. Openings for ventilation must not be blocked or covered.
- Do not place this telephone on an unstable cart, stand, or table as it may fall, resulting in damage.
- Avoid using this telephone during electrical storms to prevent the risk of electric shock from lightning.
- Unplug this telephone from the phone jack and contact Customer Support if the following conditions occur:
  - When it is exposed to rain or water
  - When it fails to operate normally
  - When it is dropped or its case is damaged
  - When it exhibits a distinct change in performance
- Do not use this telephone to report a gas leak in the vicinity of the leak.
- Follow all safety instructions and use this telephone with caution when installing or modifying telephone lines.
  - Do not install telephone wire during a lightning storm.
  - Only install telephone jacks in dry locations unless the jack is specifically designed for wet locations.
- Avoid touching un-insulated telephone wires or terminals unless the telephone line is disconnected at the network interface.

## USER SAFETY GUIDE

### Compliance (USA and Canada)

This product complies with the standards in Part 68 of the FCC Rules in the USA and CS-03 in Canada.

1. This product must be connected to the public switched telephone network through a modular telephone outlet or jack.
2. Upon the request of the local telephone service provider, the user of this product must provide the following information:
  - The "line" to which this telephone equipment will be connected (telephone number)
  - The telephone equipment's FCC registration number and ringer equivalence number. This information is printed on the back or bottom of the unit.
3. If it is determined that this equipment is malfunctioning, the FCC requires that it not be used and that it must be unplugged from the modular outlet until the problem has been corrected.
4. If the product causes harm to the telephone network, the telephone company may temporarily discontinue telephone service. Whenever possible, the telephone company will contact a customer prior to a service interruption. If advanced notice is not possible, the customer will be notified as soon as possible. The customer will be given the opportunity to correct the problem.

**TABLE OF CONTENTS**

<b>Getting Started</b>	
General Features .....	5
In the Package .....	5
Location of Controls .....	6
Getting the Telephone Ready for Use .....	7
Mounting the Phone on the Wall .....	8
Connecting the Stand for Flat Surface Placement .....	8
Installing the Batteries .....	10
Using an AC Adapter (Optional) .....	10
<b>Operational Instructions</b>	
Description of the Display .....	12
Basic Setup .....	12
Basic Instructions for Making a Phone Call .....	14
Basic Instructions for Receiving a Phone Call .....	14
Using the Last Number Redial Function .....	15
Receiving Caller ID Information .....	15
Reviewing the Caller ID List .....	15
VIP Function .....	15
Erasing Data from the Caller ID List .....	15
Calling a Number from the Caller ID List .....	16
Storing One-Touch Memory .....	16
Dialing from One-Touch Memory .....	16
Storing Two-Touch Memory .....	16
Dialing from Two-Touch Memory .....	17
Using the Flash Function .....	17
Pause Function .....	17
Placing a Call on Hold .....	17
<b>Troubleshooting and Specifications</b> .....	
	18

## GETTING STARTED

Thank you for purchasing the JT-P531 Caller ID Speaker Phone. Please read and follow the instructions in this manual carefully to ensure that your product operates correctly.

### General Features

- FSK/DTMF Dual System Caller ID Speaker Phone
- Redial, flash, and hold functions
- Two One-Touch Number Memory
- Ten Two-Touch Number Memory
- Message Memory (up to 94 messages)
- Digital Incoming Call Display (15 digits for name/14 digits for number)
- LCD screen (Six levels of brightness adjustment)
- Real-time Clock Display
- VIP Function
- Music-on-Hold Function
- Tone/Pulse Mode Selection
- Flash Time Selection (100-900mS)
- Low Battery Indicator
- Ringer Volume Control
- Handset Volume Control
- Speaker Phone Volume Control
- Wall-mounting capability
- Simple and easy to use
- Supports four (4) languages (English, Spanish, French, and Italian)

### In the Package

- Corded phone
- Stand
- Instruction manual
- Warranty card



# GETTING STARTED

## Location of Controls

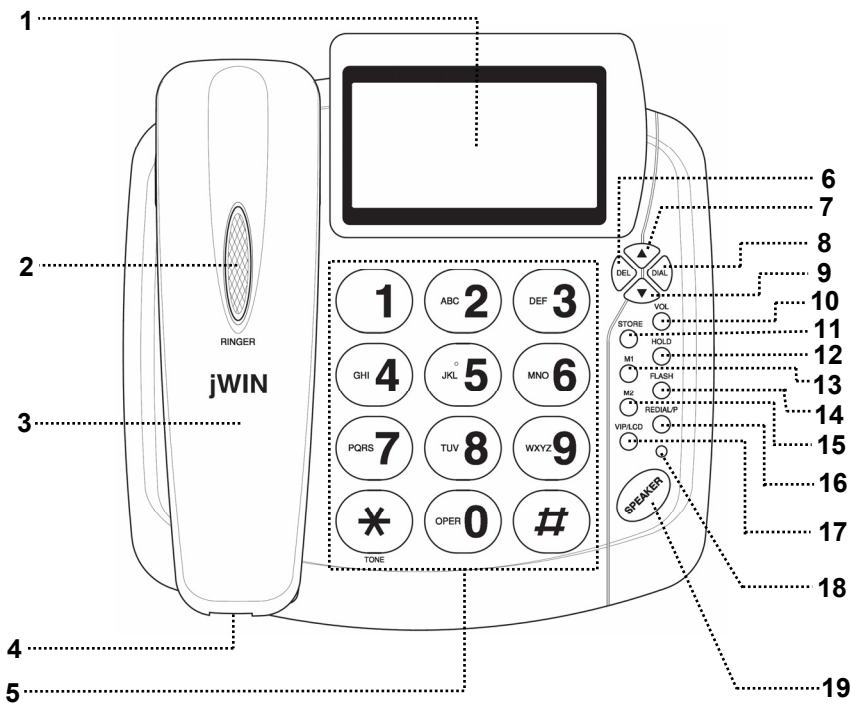

1. LCD Screen	11. STORE Button
2. Ringer Light	12. HOLD Button
3. Handset	13. M1 (Memory 1) Button
4. Handset Jack	14. FLASH Button
5. Numeric keypad	15. M2 (Memory 2) Button
6. DEL. Button	16. REDIAL/P Button
7. ▲ Button	17. VIP/LCD Button
8. DIAL Button	18. Indicator Light
9. ▼ Button	19. SPEAKER Button
10. VOL Button	

# GETTING STARTED

## Getting the Telephone Ready for Use

1. Choose a desired location for the unit (mounted or on a flat, level surface).
2. Adjust the removable tab located above the speaker on the base of the phone.

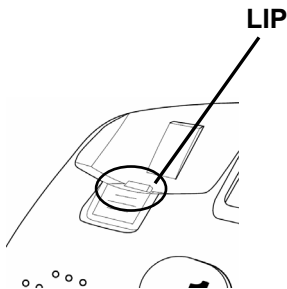
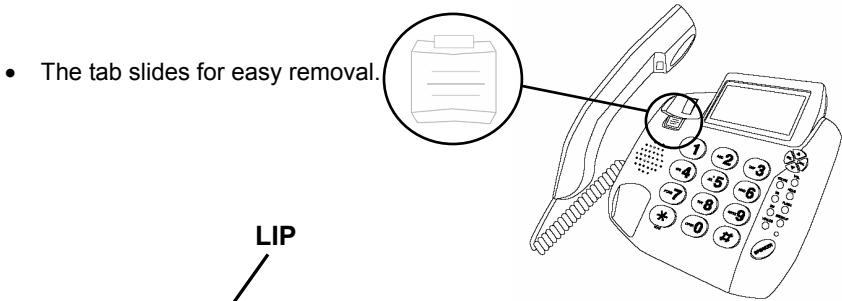

- For wall mounted units, the side of the tab with the lip must be situated toward the top of the base to allow the handset to hang on the base without falling. The lip fits into the opening under the earpiece on the handset.

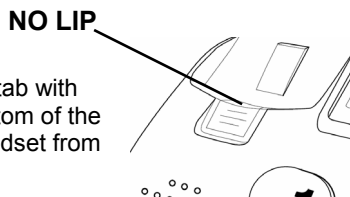

- For flat, level placement, the side of the tab with the lip should be situated toward the bottom of the base to allow smooth removal of the handset from the base.

3. Plug one end of the coiled telephone cord into the jack on the handset, and the other into the matching jack on the left side of the unit's base.

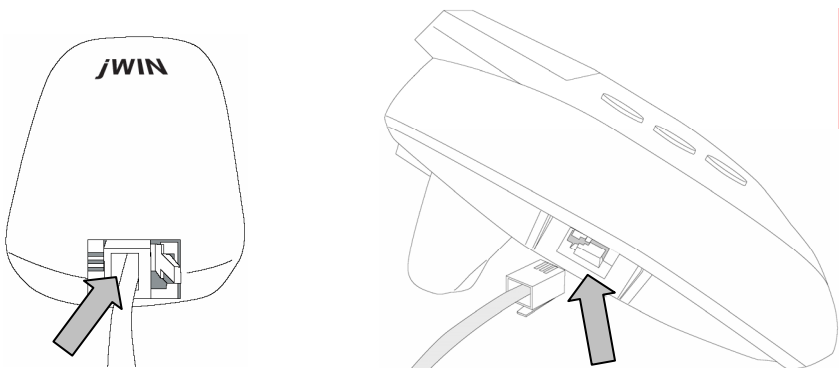



## GETTING STARTED

### Getting the Telephone Ready for Use- continued

4. Plug one end of the flat telephone cord into the jack in the rear of the unit's base (marked TEL-LINE), and the other end into the wall jack which supplies telephone service.

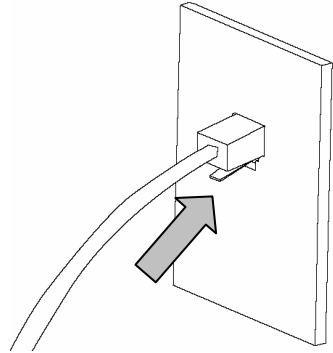
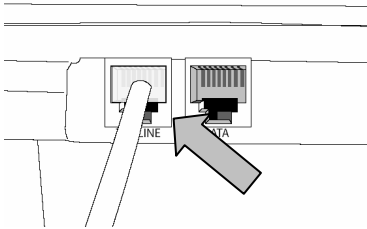

### Mounting the Phone on the Wall

1. Choose a desired wall location for the phone.

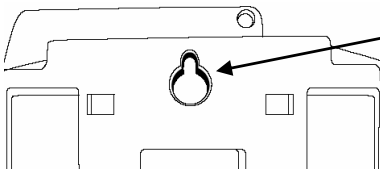

Wall mount  
hanger

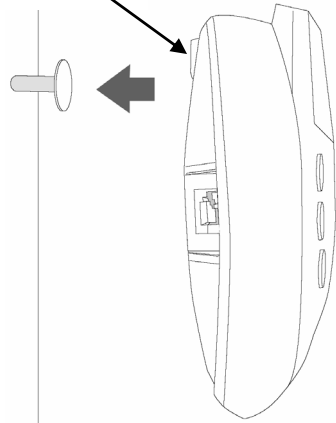

2. Align nails or picture hooks with the wall-mount hanger located on the bottom surface of the base.
3. Hammer nails or hangers into the wall so the phone can hang flush with the wall.
4. Set the removable receiver tab with lip toward the top of the base.
5. Hang phone on nails or picture hangers making certain that the phone is flush with the wall.

### Connecting the Stand for Flat Surface Placement

When using the JT-P531 on a flat surface, it is recommended that you use the included stand.

1. Remove the stand from the plastic wrapper.
2. Turn the phone upside down with the battery compartment closest to you.
3. The stand attaches above where the battery compartment is located.

# GETTING STARTED

## Connecting the Stand for Flat Surface Placement-continued

- There are four (4) slots. The top two (2) slots are situated closer together and are on the bottom surface of the unit. The bottom two (2) slots are situated further apart and are located in indented rectangular sections which are cut into the bottom surface.

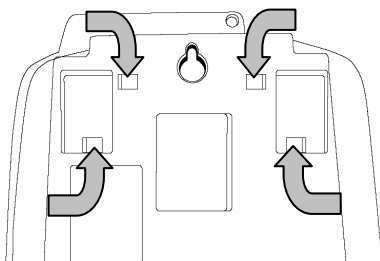

- Line up the top two lips on the stand with the top two (2) slots on the bottom of the unit and place the lips into the slots.

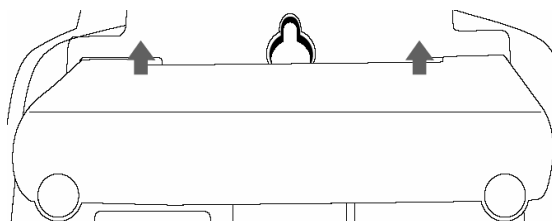

- Using your thumbs, gently press the stand just above the bottom two (2) lips until the stand clicks into position.

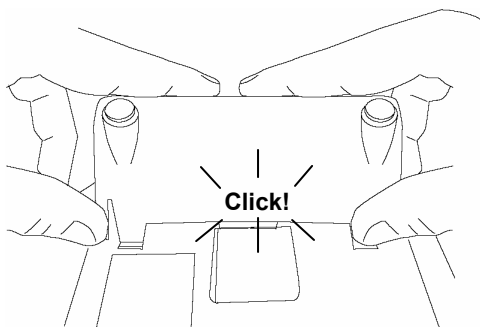

- Return the phone to the upright position.

# GETTING STARTED

## Installing the Batteries

The JT-P531 requires three (3) AAA batteries, which are used to operate the speakerphone, the LCD display, and to retain Caller ID data and any settings programmed into the phone. Using an optional AC adapter (see Notes below) will increase the battery's life span, requiring less frequent battery replacement.

1. Remove the battery compartment cover at the bottom of the unit.

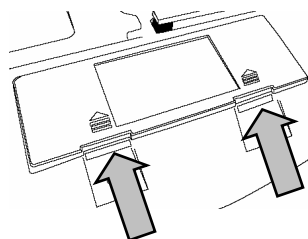
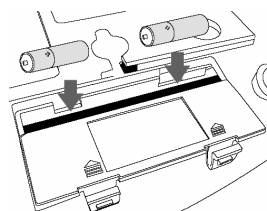

2. Carefully install three (3) AAA batteries by observing the polarity direction shown in the battery compartment.

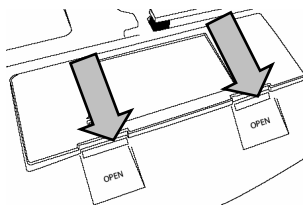

3. Replace the cover.

### Notes:

- Whether installing batteries for the first time or replacing them, do not mix old and new batteries, nor should alkaline, standard (zinc-carbon), or rechargeable (nickel-cadmium) batteries be used together.
- When not using the phone for a long period of time, remove the batteries to prevent possible leakage and corrosion. Keeping the phone powered by the optional AC adapter, discussed below, will preserve all data and settings in the phone's memory.

## Using an AC Adapter (Optional)

If an optional AC power adapter (not included) is used, it plugs into the DC 9V jack on the rear of the unit and converts common household AC electricity into low voltage DC power, suitable for the phone's operation. Such adapters are commonly available, but before buying, be sure that it can provide the necessary +/- polarity, as indicated on the unit's rear panel, just below the DC 9V jack. Once connected, plug the adapter's other end into an un-switched (always on) AC outlet, outlet strip, or extension cord. Even when an AC adapter is employed, the use of batteries is recommended as a backup in case AC power is ever lost.



## GETTING STARTED

### Notes:

- If neither the batteries nor an AC adapter are connected, the JT-P531 will still be able to place and receive calls, but the speakerphone, the ability to store Caller ID data, and the LCD display functions will not operate.
- When batteries are used without an AC adapter, they should be replaced when the display dims.
- When replacing the batteries without an AC adapter connected, it's the best to pick up the handset before removing the batteries. Doing so prevents the loss of stored Caller ID data and programmed settings while the batteries are being replaced. If not done, it's possible that all settings and data in the phone's memory will be lost.

## OPERATIONAL INSTRUCTIONS

### Description of the Display

The JT-P531 features a three-line LCD. The top line displays basic information; the middle line shows the telephone number of the incoming call; and the bottom line displays the name of the caller. Also included on the display is helpful information such as:

- The word, "LOW" appears on the screen when the battery power is low.
- The word, "NEW" appears on the screen when there are new incoming calls.
- The word, "CALL#" indicates the total number of incoming calls received.
- Hour: Minute Morning/Afternoon Day/Month are displayed. For example: "10:15 AM 21/03" (Year is not displayed)
- If the time and date programmed into the telephone differ from the telephone company's record, the telephone will automatically adjust to the service provider's information when receiving calls.
- When there has been no operation on the telephone for more than 20 seconds, the LCD will only display the time and date, amount of received calls and amount of incoming calls.
- The JT-P531 can store up to 94 incoming calls. Once 94 calls have been received, the oldest call will automatically erase when a new call is received.

### Basic Setup

**Note:** Please be sure the telephone lines are connected well and batteries or AC adapter are installed before starting setting.

#### 1. HOW TO ENTER THE SETUP MODE

- Long Press (Approx. 4 seconds) **[DIAL]** to enter setup menu.
- The LCD display will appear as shown here, however, you must use **[▲]** or **[▼]** to select from the menu including Select Language, Local Area Code, Regional AC's (Area Codes), and Date/Time Setting.
- Press **[DEL]** to exit setting manually or it will exit automatically if no selection is made after 5 seconds.

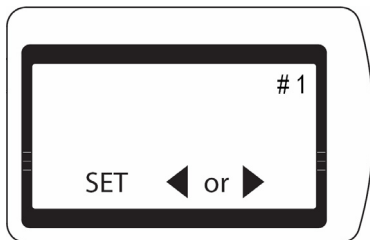

#### 2. SET DATE / TIME

- When the LCD displays "DATE / TIME", press **[DIAL]** to enter this function.
- Press **[▲]** or **[▼]** to set the month.
- Press **[DIAL]** to confirm.
- Use the same procedure to set the day hour, and minute.

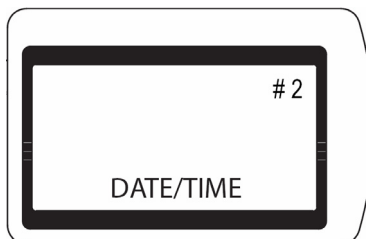

# OPERATIONAL INSTRUCTIONS

## Basic Setup-continued

### 3. SET AREA CODE

- When the LCD displays “LOCAL AREA CODE”, press **[DIAL]** to enter this function.
- Use **[▼]** to select the each digit of area code.
- Use **[▲]** to confirm each digit and move to next digit
- Press **[DIAL]** to confirm the first digit.
- Use the same procedure to set the rest digits.

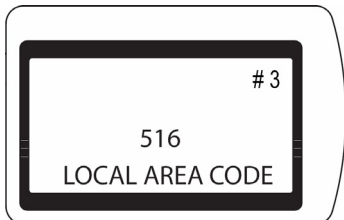

### 4. REGIONAL ACs (Area Codes)

- When the LCD displays “REGIONAL AC’S-1”, press **[DIAL]** to enter.
- Use **[▼]** to select the first digit of the regional area code.
- Use **[▲]** to advance to the next digit
- Press **[DIAL]** to confirm each digit.
- Store up to two (2) regional area codes.

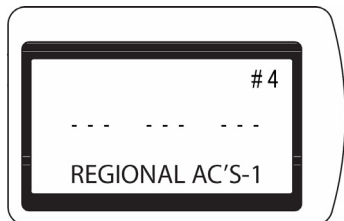

### 5. SET LANGUAGE

- When the LCD displays “SELECT LANGUAGE”, press **[DIAL]** to enter menu.
- Use **[▲]** or **[▼]** to select the desired language, ENGLISH (English), ESPANOL (Spanish), FRANCAIS (French), ITALIANO (Italian).

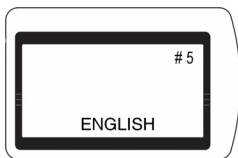
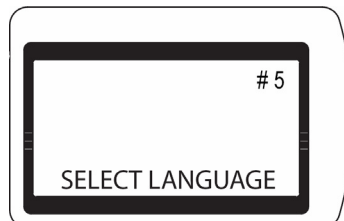

- Press **[DIAL]** to confirm your choice.

### 6. T/P DIAL MODE

- When the LCD displays “T/P DIAL MODE,” press **[DIAL]** to enter this menu.
- Press **[▲]** or **[▼]** to choose TONE (T) or PULSE (P).
- Press **[DIAL]** to confirm.

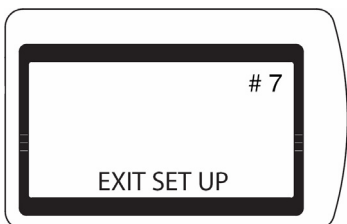
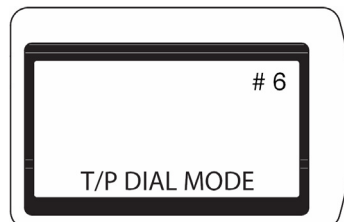

### 7. EXIT MENU

- When the LCD displays, “EXIT SETUP,” press **[DIAL]** to exit the setup menu.

## OPERATIONAL INSTRUCTIONS

### Basic Setup-continued

#### 8. LCD ADJUSTMENT

- Press **[VIP/LCD]** to adjust the brightness of the LCD screen.
- There are six (6) levels of brightness (Level 3 is the default setting)

#### 9. SAVING NUMBERS IN THE PHONEBOOK

- Press **[STORE]**
- Press **[▲]** or **[▼]** to scroll phone listings
- Press **[STORE]** again to enter phone number
- Enter number you wish to save.
- Press **[STORE]** again to save number. Cursor will blink below the number
- Enter the name of the person whose number you entered.
- Press **[STORE]** again to save.
- Press **[STORE]** once more to exit phonebook menu.

#### 10. FLASH TIME SELECT

- Press **[STORE]** followed by **[FLASH]**, "FLASH=600MS," will display on the screen.
- Press **[▲]** or **[▼]** to select a suitable flash time (100/200/300/400/500/600/700/800/900MS).
- Press **[STORE]** again to confirm and exit the setting.

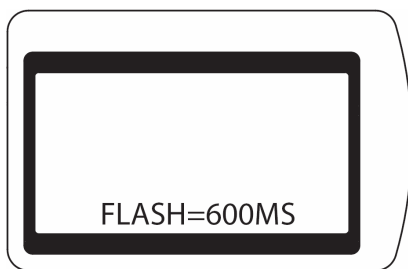

#### 11. RINGER VOLUME CONTROL

- When phone is not in use or when there is an incoming call ringing, press **[VOL]** to adjust the ringer volume from 1 to 3.

**Note:** "□□□" is minimum and "■□■" is maximum.

#### 12. HANDSET VOLUME CONTROL

- Pick up the handset
- Press **[VOL]** to adjust the handset volume from 1 to 4.

#### 13. SPEAKER PHONE VOLUME CONTROL

- Press **[SPEAKER]** and **[VOL]**.
- Adjust the speaker phone volume from 1 to 4.

### Basic Instructions for Making a Phone Call

1. Remove the handset from base and listen for dial tone.
2. Listen for a dial tone to indicate that the phone is connected.
3. Dial the number you wish to call using the number pad.

### Basic Instructions for Receiving a Phone Call

Telephone will ring to alert the user of an incoming call.

1. Lift the handset, hold earpiece to your ear and speak into the mouthpiece.
2. To hang up, return the handset to the base at the conclusion of call.

## OPERATIONAL INSTRUCTIONS

### Using the Last Number Redial Function

1. Remove the handset from base and listen for dial tone.
2. Use the **[REDIAL/P]** button redial the last number dialed (typically most helpful when the line is busy).

### Receiving Caller ID Information

Your telephone service provider must offer caller ID service in order to activate the caller ID function on this unit.

1. Incoming Call Display.
  - When there is an incoming call, the LCD will display the number, area code, name, time and date of the call.
2. Make note of the following indicators.
  - “UNKNOWN NUMBER”: The call is made through a telephone company that does not offer caller ID service or does not transfer such information long distance.
  - “BLOCKED NUMBER”: Some areas allow callers the option of preventing their telephone data from display on other telephones.
  - “MESSAGE WAITING”: This will appear if you have a message service through your telephone service provider and someone has left a message.

### Reviewing the Caller ID List

Press **[▲]** or **[▼]** to review incoming calls (up to 94 calls).

### VIP Function

1. When reviewing the caller ID list using **[▲]** or **[▼]**, press **[VIP]** to store a specific number from the list into the VIP record.
2. Press **[VIP]** again to cancel the VIP function.

**Note:** The number cannot be deleted from the caller ID list once it has been saved to the VIP record.

### Erasing Data from the Caller ID List

1. Press **[▲]** or **[▼]** to find the number you wish to erase.
2. Press **[DEL]** to erase the number from the list.
3. Press **[DEL]** for approximately 3 seconds for the LCD to show “ERASE ALL?”
4. Press **[DEL]** again to erase the entire caller ID list.

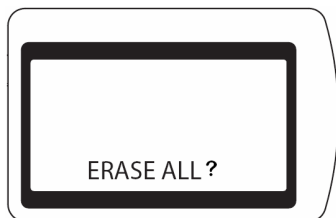



## OPERATIONAL INSTRUCTIONS

### Calling a Number from the Caller ID List

1. With the handset is on the hook, press [**▲**] or [**▼**] to find the number you wish to call.
2. Press [**DIAL**] once; the LCD will display "PICK UP OR ADJ," (for a 10 digit number) or "PICK UP PHONE." (for a 7 or 11 digit number).
3. Pick up the handset and the number on the display will automatically dial.
4. With the handset off the hook, press [**▲**] or [**▼**] to find the number you wish to call.
5. Press [**DIAL**] once. For 7 and 11 digit numbers, the number will automatically dial. For 10 digit numbers, the phone will add the number "1" automatically as the first digit.



### Storing One-Touch Memory

1. While the handset is on the hook, press [**M1**] or [**M2**].
2. The LCD will show "E1" or "E2."
3. Press [**STORE**] to enter.
4. Input the number you wish to save.
5. Press [**STORE**] again to confirm.

**Note:** Press [**DEL**] to cancel the current number while entering.

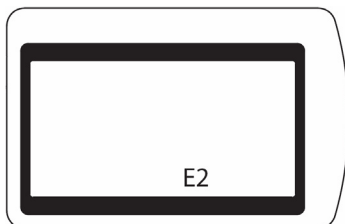

### Dialing from One-Touch Memory

1. Pick up the handset or press [**SPEAKER**].
2. Press [**M1**] or [**M2**] to dial the number automatically.

### Storing Two-Touch Memory

1. While the handset is on the hook, press [**STORE**].
2. The LCD will display "MO-M9"
3. Select and press the number from the keypad 0-9
4. Press [**STORE**] to enter
5. Input the desired telephone number
6. Press [**STORE**] to confirm and advance to Name Input mode.
7. Input the name using the letters on the phone keypad (For example, to enter the letter "C," press the number 2 three times).
8. Press [**STORE**] again to confirm.

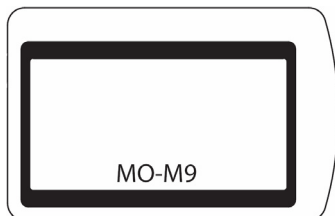

**Note:** Press [**DEL**] to cancel the current number or name while entering.

## OPERATIONAL INSTRUCTIONS

### Dialing from Two-Touch Memory

1. Pick up the handset or press **[SPEAKER]**.
2. Press **[DIAL]** and number (0-9). The number in memory will dial automatically.

### Using the Flash Function

When the JT-P531 is used in an office equipped with centralized phone system PABX, this telephone can transfer and hold calls.

1. Ask the calling party to hold.
2. Press and release **[FLASH]**.
3. Dial the number or extension to which the call is directed.
4. When the intended call recipient answers, announce the call and hang up.
5. If there is a busy signal or no answer, press and release **[FLASH]** to re-connect to the calling party.

**Note:** Not all PABX systems are compatible with JT-P531. Please check with your telephone service provider for compatibility.

### Pause Function

In some places, PABX or long distance service requires a pause function within the dialing sequence. The JT-P531 provides an adjustable pause time preset function.

1. Press **[STORE]** and **[REDIAL/P]**.
2. The LCD will display "PAUSE=4S."
3. Press **[▲]** or **[▼]** to select pause time from 1/2/3/4/5/6/7/8/9S (1-9 seconds).
4. Press **[STORE]** to confirm and exit.

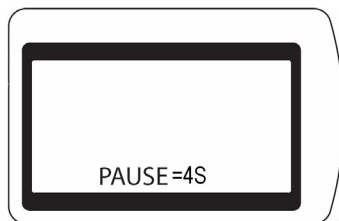

### Placing a Call on Hold

While speaking on the phone, it may be necessary to place a call on hold. It is suggested that before placing a call on hold, ask the caller if it would be okay to place them on hold for a moment.

1. Press the **[HOLD]**.
2. The LCD will display "MIC MUTE."
3. Music will play indicating that the caller is now on hold.
4. If you place the handset back into the receiver, the music will play through the speaker on the main unit base until the call is picked up.
5. If you simply put the handset down without placing it back on the receiver, the music will play through the earpiece until the call is picked up again.
6. To return to the original call, press **[HOLD]** again or press **[SPEAKER]** and resume the call as normal.

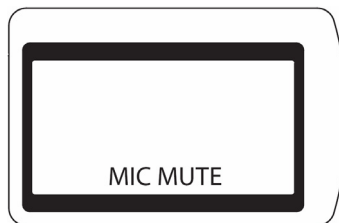

## TROUBLESHOOTING & SPECIFICATIONS

### Troubleshooting

- **No Display on LCD Screen**
  - Brightness on display may be turned down.
    - *Increase brightness level.*
  - No batteries or batteries are improperly installed.
    - *If no batteries, install 3 AAA batteries as directed or*
    - *Install optional AC Adapter (not included).*
    - *Make sure batteries observe to polarities (+/-) as indicated inside the battery compartment.*
  
- **No Dial Tone when handset is picked up**
  - Phone may not be connected properly.
    - *Make sure the handset jack is connected to the base jack using the coiled wire.*
    - *Make sure the base jack (TEL-LINE) jack is connected to the wall telephone jack using the flat wire.*
  - Telephone service may be interrupted by the telephone company
    - *Contact your telephone company to check the status of your service.*
  
- **Static or interruptions during phone conversation**
  - Bad connection between phones
    - *Hang up and dial number again*
  - Harsh weather conditions and/or lightning
    - *Hang up and dial number when weather conditions improve*
  
- **Can only receive incoming calls and cannot make outgoing calls**
  - Telephone service may be limited or suspended by your telephone company
    - *Contact your telephone company to check the status of your service.*

### Specifications

- **System:** FSK
- **Display Type:** Liquid Crystal Display (LCD)
- **Operating Temperature:** 5C~40C (41F~104F)
- **Storage Temperature:** -20C~65C (-4F~149F)

# jWIN

**TEL: 516-626-7188**

**FAX: 516-626-7105**

**website: [www.jWIN.com](http://www.jWIN.com)**

© 2007 jWIN Electronics Corp. All rights reserved. No portion of this printed material or product enclosed herewith including design, shape and graphics, may be reproduced or transmitted in any form without the expressed written consent of jWIN Electronics Corp. by any means, electronic or mechanical, including photocopying, recording, or by use of an information storage and retrieval system. Any unauthorized distribution or reproduction of this printed material or product, or any portion thereof, will be prosecuted to the fullest possible extent of the law.

Printed in China

Download from [Www.Somanuals.com](http://Www.Somanuals.com). All Manuals Search And Download.

## Free Manuals Download Website

<http://myh66.com>

<http://usermanuals.us>

<http://www.somanuals.com>

<http://www.4manuals.cc>

<http://www.manual-lib.com>

<http://www.404manual.com>

<http://www.luxmanual.com>

<http://aubethermostatmanual.com>

Golf course search by state

<http://golfingnear.com>

Email search by domain

<http://emailbydomain.com>

Auto manuals search

<http://auto.somanuals.com>

TV manuals search

<http://tv.somanuals.com>