

jWIN

**DVD Player with 5.1Channel Audio Output and
Progressive Scan Feature**

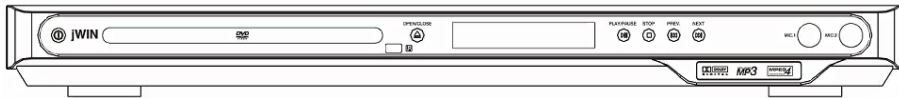

JD-VD509

INSTRUCTION MANUAL

**Please read this manual carefully before operating and
save it for future reference.**

Have a question? Please visit www.jWIN.com

USER SAFETY GUIDE

IMPORTANT SAFETY PRECAUTIONS

	CAUTION RISK OF ELECTRIC SHOCK DO NOT OPEN	
	The lightning flash with an arrowhead symbol within an equilateral triangle is intended to alert the user of the presence of un-insulated "dangerous voltage" within the unit's cabinet that may be of sufficient magnitude to constitute a risk of electric shock.	
	The exclamation point within an equilateral triangle is intended to alert the user of the presence of important operating, maintenance and servicing instruction in the manual accompanying the unit.	

WARNING: To prevent fire or shock hazard, do not expose this appliance to rain or moisture.

	<p>CLEANING</p> <p>Always disconnect unit from power supply before attempting to clean it. Use soft cloth moistened with soapy water, and wipe gently. Do not use solvents or abrasive materials.</p>
	<p>LASER SAFETY</p> <p>This unit utilizes laser technology. Only a qualified professional should remove the cover or attempt to service this device, due to possible eye injury.</p> <p>CAUTION – CLASS 1 LASER PRODUCT</p> <p>Use of controls adjustments and/or performance of procedure other than specified herein may result in hazardous radiation exposure.</p>
	<p>DANGER</p> <p>Invisible laser radiation when open and interlock failed or defeated. Avoid direct exposure to beam. CAUTION: HAZAROUS LASER RADIATION WHEN OPEN AND INTERLOCK DEFEATED.</p>

USER SAFETY GUIDE

IMPORTANT SAFETY PRECAUTIONS

<p>You can help to protect the environment!</p> <p>Please remember to respect the local regulations: Hand in the non-working electrical equipment to an appropriate waste disposal center.</p>	
<p>FOR RECHARGEABLE BATTERY</p> <p>Attention: NI-MH must be recycled and disposed of properly.</p>	

IMPORTANT SAFETY WARNINGS

1. FCC regulations state that any change or modification to the equipment, not expressly approved by maker or its authorized parties, could void user's authority to operate this equipment.
2. To prevent fire or electric shock, do not expose the unit to water, rain, or moisture.
3. Never attempt to open the cabinet. Dangerous high voltages are present in the unit. Always refer servicing to a qualified technician.
4. Before using the player please ensure that your local AC voltage is suitable for this unit.

FCC RULE

This device complies with Part 15 of the FCC Rules. Operation is subject to the condition that this device does not cause harmful interference.

Note: Changes or modifications not expressly approved by the party responsible for compliance could void the user's authority to operate the equipment.

This product incorporates copyright protection technology that is protected by method claims of certain U.S. patents and other intellectual property rights owned by Macrovision Corporation and other rights owners. Use of this copyright protection technology must be authorized by Macrovision Corporation, and is intended for home and other limited viewing uses, only unless otherwise authorized by the Macrovision Corporation. Reverse engineering or disassembly is prohibited.

Apparatus claims of US Patent Nos. 4,631.603; 4,819.098; 5,315.448 and 6,516.132; licensed for limited viewing uses only.



This symbol indicates that this product incorporates double insulation between hazardous mains voltage and user accessible parts. When servicing, use only identical replacement parts.

USER SAFETY GUIDE**IMPORTANT SAFETY INSTRUCTIONS**

1. **READ INSTRUCTIONS** – All the safety and operating instructions should be read before the appliance is operated.
2. **RETAIN INSTRUCTIONS** – The safety and operating instructions should be retained in a secure place for future reference.
3. **HEED WARNINGS** – All warnings on the appliance and in the operating instructions should be adhered to.
4. **FOLLOW INSTRUCTIONS** – All operating and use instructions should be followed.
5. **WATER AND MOISTURE** – The appliance should not be used near water. For example: near a bathtub, kitchen sink, laundry tub, and/or swimming pool.
6. **VENTILATION** – The appliance should be situated so that its location and position does not interfere with its proper ventilation. For example, the appliance should not be situated on a bed, sofa, rug or similar surface that may block the ventilation openings; or, be placed in a built-in installation, such as a bookcase or cabinet that may impede the flow of air through the ventilation openings.
7. **HEAT** – The appliance should be situated away from heat sources such as radiators, heat registers, stoves, or other appliances (including amplifiers) that produce heat.
8. **POWER SOURCES** – The appliance should be connected to a power supply only of the type described in the operating instructions or as marked on the appliance. If you are not sure of the type of electrical power supplied to your home, consult your dealer or local power company. For those sets designed to operate from battery power, refer to the operating instructions.
9. **GROUNDING OR POLARIZATION** – Do not defeat the safety purpose of the polarized or grounding-type plug. A polarized plug has two blades with one wider than the other. A grounding type plug has two blades and a third grounding prong. The wide blade or the third prong are provided for your safety. If the provided plug does not fit into your outlet, consult an electrician for replacement of the obsolete outlet.
10. **POWER CORD PROTECTION** – Power supply cords should be routed so that they are not likely to be walked on or obstructed by items placed upon or against them. Pay particular attention to cords at plugs, convenience receptacles, and the point at which they exit from the appliance.
11. **NONUSE PERIODS** – The power cord of the appliance should be unplugged from the outlet when the appliance is to be left unused for an extended period of time.
12. **OBJECT AND LIQUID ENTRY** – Care should be taken so that objects do not fall and liquids are not spilled into the device's openings.
13. **CARTS AND STANDS** – The appliance should be used only with a cart or stand that is recommended by the manufacturer. An appliance and cart combination should be moved with care. Quick stops, excessive force, and uneven surfaces may cause the appliance and cart combination to overturn

**USER SAFETY GUIDE****IMPORTANT SAFETY INSTRUCTIONS – CONTINUED**

14. **CLEANING** – The appliance should be cleaned with a dry cloth.
15. **ATTACHMENTS** – Only use attachments / accessories specified by the manufacturer.
16. **DAMAGE REQUIRING SERVICE** – The appliance should be serviced by qualified service professional when:
 - a. The power-supply cord or plug has been damaged.
 - b. Objects have fallen into, or liquid has been spilled into the appliance's apertures.
 - c. The appliance has been exposed to rain or water.
 - d. The appliance has been dropped and suffered damage.
 - e. The appliance does not appear to operate normally, or exhibits a change in performance.
17. **SERVICING** – The user should not attempt to service the appliance beyond that described in the user's operating instructions. All other servicing should be referred to qualified service professional.
18. **REPLACEMENT PARTS** – When replacement parts are required, be sure the service technician certifies in writing that he has used replacement parts specified by the manufacturer that have the same characteristics as the original parts. Unauthorized substitutions may result in fire, electric shock, or other hazards.
19. **SAFETY CHECK** – Upon completion of any service or repairs to the set, ask the service technician to perform routine safety checks (as specified by the manufacturer) to determine that the set is in safe operating condition, and to so certify.
20. **BATTERY USAGE** – To prevent battery leakage, which may result in bodily injury, property damage or damage to the unit, follow these instructions:
 - a. Install all batteries correctly according to the polarity (+ -) as marked on the unit.
 - b. Do not mix old and new batteries, carbon and alkaline, etc.
 - c. Remove batteries from the unit when the device will not be used for an extended period of time.
21. **LEAD AND MERCURY** – This product may contain lead and/or mercury. Disposal of these materials may be regulated by your local authorities due to environmental considerations. For more detailed disposal or recycling information, please contact your local authorities or the EIA (Electronic Industries Alliance) – <http://www.eiae.org>
22. **LIGHTING** – During a lighting storm, unplug the power cord from the wall outlet and disconnect the antenna. This will prevent damage to the device due to lighting and power-line surges.
23. **OVERLOADING** – Do not overload the wall outlets, extension cords, or convenience receptacles beyond their capacity, since this can result in fire or electric shock. Always turn this device off when it is not to be used. When this device is left unattended and unused for the long period of time, unplug it from the wall outlet as a precaution against the possibility of an internal malfunction that could create a fire hazard.

TABLE OF CONTENTS**GETTING STARTED**

Compatibility	8
General features	9
Location of controls on the main unit	10
Location of indications on the VFD screen	11
Location of controls on the remote control	11
Installing the remote control batteries	12
Notes on using the remote control	12
Brief instructions on installing the DVD player	13
About the audio outputs	14
About the video outputs	14
Connecting to a TV set with 2-channel audio input	15
Connecting to an audio amplifier with digital audio input	16
Connecting to a TV set and an amplifier with 5.1-channel audio output	17
Preparing the unit and attached devices	18
Navigating the setup menu	18
About the system setup	19
About the language setup	21
About the audio setup	22
About the video setup	23
About the speaker setup	24
About the digital setup	25

OPERATING WITH A REMOTE CONTROL

[STANDBY] button	27
[0 -9, 10+] button	27
[OPEN/CLOSE] button	27
[PLAY] button	27
[PAUSE] button	27
[STOP] button	27
[▶▶] button	27
[◀◀] button	28
[◀◀] button	28
[▶▶] button	28
[MENU] button	28
[A – B] button	28
[SLOW] button	28
[RETURN] button	29
[TITLE] button	29
[REPEAT] button	29
[VOL] button	29
[MUTE] button	29

TABLE OF CONTENTS**OPERATING WITH A REMOTE CONTROL (CONTINUED)**

[ZOOM] button	29
[ANGLE] button	29
[LANGUAGE] button	30
[SUBTITLE] button	30
[P/N] button	30
[DIGEST] button	30
[MODE] button	30
[PBC] button	30
[PSCAN/NORMAL] button	30
[DISPLAY] button	31
[TIME] button	31
[GOTO] button	32
[L/R] button	32
[RANDOM] button	33
[SETUP] button	33
[PROG] button	33

ADVANCED FEATURES/ANAL FEATURES

Playing MP3 CDs	34
Using the microphones	34
About Kodak Picture CDs	34

CARE AND MAINTENANCE GUIDES

Handling a disc	35
Cleaning the unit	35

TROUBLESHOOTING GUIDE 36**SPECIFICATIONS** 37

GETTING STARTED

COMPATIBILITY



DVD VIDEO



AUDIO CD



MP3 CD



Kodak Picture CD



Dolby® Digital



Multi-angle



Subtitle choices



Audio choices

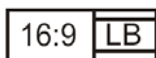

TV Aspect Ratio

MPEG4 MPEG4 VIDEO

This product incorporates copyright protection technology that is protected by method claims of certain U.S patents and other intellectual property rights owned by Macrovision Corporation and other rights owners. Use of this copyright protection technology must be authorized by Macrovision Corporation, and is intended for home and other limited viewing uses only unless otherwise authorized by Macrovision Corporation. Reverse engineering or disassembly is prohibited.

The product complies with the Kodak Picture CD format and will display Kodak Picture CDs. The "Kodak Picture CD Compatible" logo is a trademark of Eastman Kodak Company and is used with the permission.

Manufactured under license from Dolby Laboratories. "Dolby" and the double-D symbol are trademarks of Dolby Laboratories. Confidential Unpublished Works. © 1992 - 1997 Dolby Laboratories, Inc. All rights reserved.

GETTING STARTED

Thank you for purchasing JD-VD509. Unpack the unit and make sure all the accessories are put aside so they will not be lost. We recommend that you retain the original carton and packaging materials for future use, should you transport or ship the unit in the future.

Progressive-Scan DVD Player with 5.1Channel Audio Output

- Capable of MPEG4 decoding
- Capable of Dolby Digital decoding
- Interlaced and progressive-scan video outputs
- Coaxial digital audio output and 5.1 channel audio output
- Multiple subtitle, angle, and audio functions
- Programmed playback and zoom operation
- Slow and fast motion playbacks
- Convenient OSD (On-Screen Display) and screen saver
- Integrated two microphone jacks
- Playable Media: DVD / VCD / SVCD / MPEG4 CD / MP3 CD / JPEG CD / Audio CD / Kodak Picture CD

In the Box

- Main unit
- Remote control (battery included)
- AV cable
- Instruction manual
- Warranty card

ABOUT THE DISC ERROR

This compact disc player has built-in error compensation circuits to correct for minor defects in a disc. There are limits, however, to the amount of correction available. In some cases, the DVD player may skip some tracks, or parts of tracks, on a disc during disc play. This problem may be caused by defects (such as scratches) in the disc being played, which are too large for the error compensation circuits to handle. If you encounter this problem, try a new disc before having the unit serviced. If the DVD player operates normally, the skipping problem is probably due to a defective disc.

Note: Only the above types of discs can be played on this unit.

GETTING STARTED

Location of Controls on the Main Unit

[Front Panel]

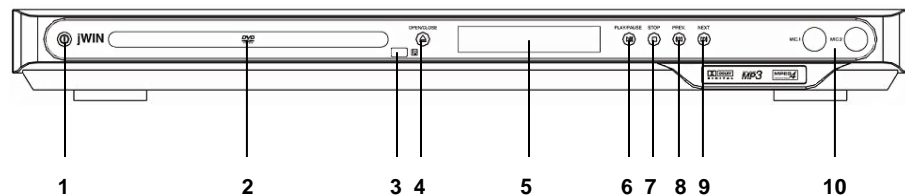

- | | |
|--------------------------|------------------------|
| 1. Power button | 6. Play / Pause button |
| 2. Disc loader | 7. Stop button |
| 3. Remote control sensor | 8. Prev. button |
| 4. Open / Close button | 9. Next button |
| 5. VFD screen | 10. Microphone jacks |

[Rear Panel]

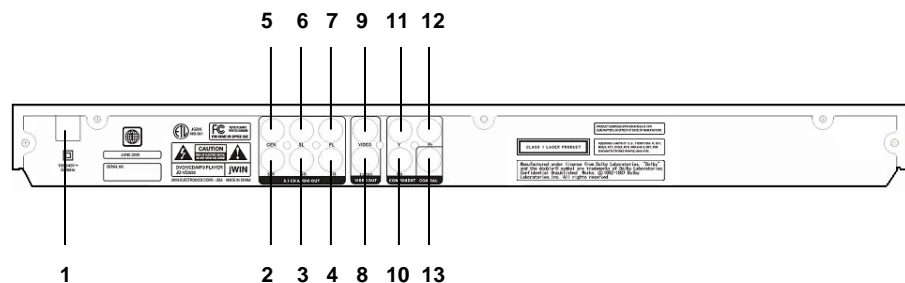

- | | |
|--|------------------------------------|
| 1. Power cord | 8. S-Video output |
| 2. Audio output for the subwoofer (SW) | 9. Composite video output |
| 3. Audio output for the rear right speaker (SR) | 10. Component video output (Pb/Cb) |
| 4. Audio output for the front right speaker (FR) | 11. Component video output (Y) |
| 5. Audio output for the center speaker (CEN) | 12. Component video output (Pr/Cr) |
| 6. Audio output for the rear left speaker (SL) | 13. Coaxial digital audio output |
| 7. Audio output for the front left speaker (FL) | |

GETTING STARTED

Location of Indications on the VFD Screen

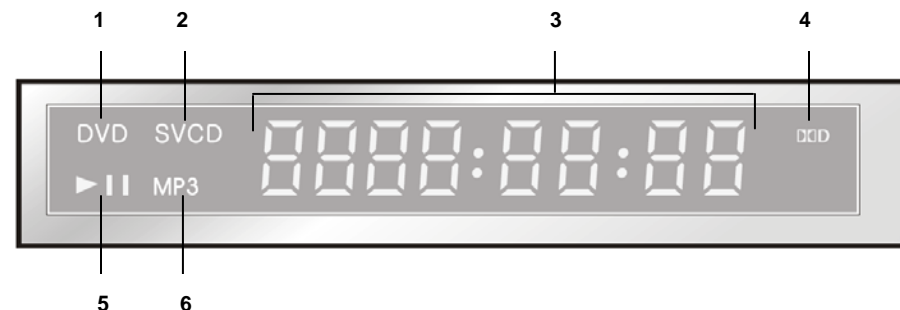

- | | |
|------------------------------------|-----------------------------|
| 1. DVD disc indication | 4. Dolby Digital indication |
| 2. SVCD / VCD / CD disc indication | 5. Play / Pause indication |
| 3. Playback information | 6. MP3 disc indication |

Location of Controls on the Remote Control

- | | |
|-------------------------------|----------------------|
| 1. OPEN / CLOSE | 17. STANDBY |
| 2. Numeric keys (0-9, 10+) | 18. SUBTITLE |
| 3. ZOOM | 19. LANGUAGE |
| 4. SLOW | 20. TITLE |
| 5. PAUSE | 21. ANGLE |
| 6. MENU | 22. TIME |
| 7. MOVE (◀, ▲, ▼, ▶) | 23. VOL + (Volume +) |
| 8. SETUP | 24. VOL - (Volume -) |
| 9. REV (Reverse) | 25. STOP |
| 10. FWD (Forward) | 26. PLAY |
| 11. A-B (Repeat A-B) | 27. DISPLAY |
| 12. REPEAT | 28. ENTER |
| 13. PROG (Program) | 29. GOTO |
| 14. P / N (PAL / NTSC) | 30. NEXT |
| 15. DIGEST | 31. PREV (Previous) |
| 16. L / R (Audio L / Audio R) | 32. RETURN |
| | 33. MUTE |
| | 34. RANDOM |
| | 35. PBC |
| | 36. PSCAN/NORMAL |
| | 37. MODE |

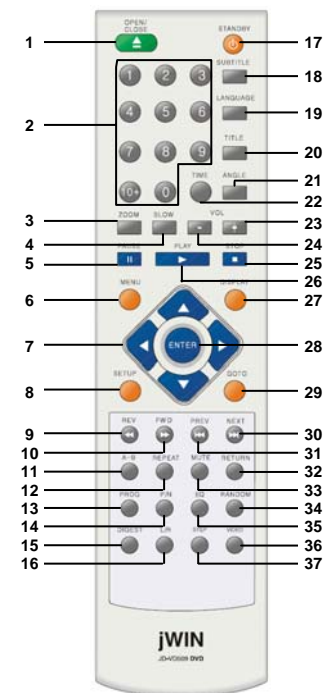

GETTING STARTED

Installing the Remote Control Batteries

1. Open the battery compartment cover on the back of the remote control.



2. Place two "AAA" batteries as shown on the picture below. Make sure that the polarity (+/-) of battery matches the marks inside the battery compartment.

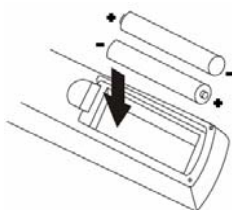

3. Close the battery compartment.



Notes on Remote Control

1. Improper use of batteries may cause the battery leakage and corrosion. To operate the remote control correctly, follow the instructions below:
 - a. Do not insert the batteries in the wrong direction.
 - b. Do not attempt to recharge, short-circuit, disassembly, heat or throw the batteries into the fire.
 - c. Do not leave the dead batteries in the remote control.
 - d. Do not use or mix the different types of batteries or old and new batteries together.

Notes on Using the Remote Control

Please note that a remote control should be pointed directly at the remote control sensor to get the better performance.

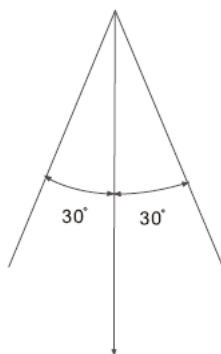

GETTING STARTED

Notes on Remote Control – Continued

- e. If you do not use the remote control for a long period of time, remove the installed batteries from the remote control to avoid possible damage from the battery corrosion. If battery leakage occurs, clean the battery compartment and then insert the new batteries. Please follow the general safety and handling instructions listed by the battery manufacturer. After cleaning, wash your hand.
2. Do not leave the remote control in an extremely hot or humid place.
 3. Do not spill water or put any liquid on the remote control.
 4. Do not expose the remote control sensor of the DVD player to a strong light source, such as direct sunlight.
 5. The battery life is approximately one year under the normal working condition. However, it significantly depends on the battery type and its working condition. If the remote control doesn't work or the signal gets weaker, replace the battery. The alkaline batteries are recommended for the longer battery life.

You can help to protect the environment!

Please do not throw the used batteries away and follow the local regulations for the proper disposal of the used batteries.



Brief Instructions on Installing the DVD Player

1. Locate the place where you want to install this unit.
2. Refer to the quick connection guides starting on the following page to connect this unit to other audio or display devices. While installing this unit to other devices, the power cord of all devices in the installation process should be properly disconnected for the safety purpose.
3. Connect the power cord of all devices again. Before connecting the power cords, please carefully follow the safety instructions in the section of the user safety guide.
4. After connecting the power cords, turn on this unit and all the attached devices.
5. Before operating this unit, set the system settings of this unit and all the attached devices based on your choice of the connection. To properly show the video and audio contents, this unit and all the attached devices must be set with the correct system settings accordingly based on your choice of the connection. For this unit, refer to the detailed system setup instructions in this user's manual. For the attached devices, refer to the detailed system setup instructions in their user's manuals respectively.

Special Notes

1. If this unit is not going to be used for a long period of time, please disconnect the power cord plug from the outlet.
2. This unit must be operated with the correct power supply corresponding to the marking label on the back of the unit.
3. This unit may not be compatible with some specially encrypted discs.

GETTING STARTED

About the Audio Outputs

This unit supports the three-way audio connection: 2-channel (stereo) audio connection, 5.1-channel surround audio connection, and digital coaxial audio connection. If you plan to connect this unit directly to your 2-channel audio or video device, you only need to connect the audio cable to the FL (Front Left) and FR (Front Right) audio output jacks on the back of this unit. If you have a home speaker system supporting the 5.1-channel surround sound or coaxial digital audio input, you need to use all the 5.1-channel audio jacks or the coaxial digital audio output. Please note that the 5.1-channel audio cables and the coaxial digital audio cable are not included in the package.

Analog Audio Outputs

- For the 2-channel audio output, two connectors, FL and FR, are used only.
- For the 5.1-channel audio output, all connectors are used.

Digital Audio Output

This unit supports the digital audio output to the external audio system through the coaxial audio cable.

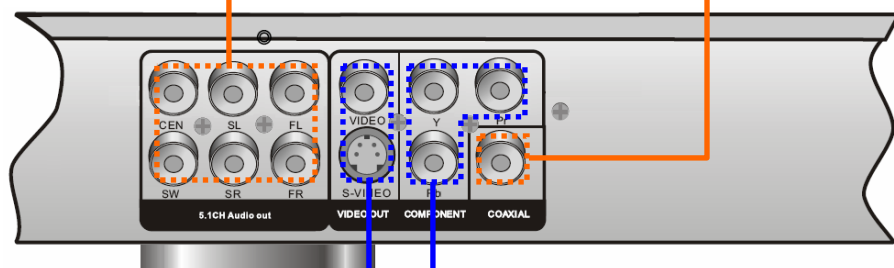

Composite Video and S-VIDEO Outputs

- The composite VIDEO output is just good enough to watch a movie on the small TV sets.
- The S-VIDEO (Separate Video) output gives you better video quality than the composite video output.

Component Video Output

The component video output (Y / Pr / Pb) gives you the best video quality, comparing to the video quality of the S-VIDEO and the composite VIDEO outputs.

About the Video Outputs

This unit also supports the three-way video connection: composite VIDEO connection, S-VIDEO connection, and component VIDEO connection. The component video output gives you the best video quality among three connections. The S-VIDEO output gives you the better video quality than the composite video output. The composite video output gives you the good video quality just enough to watch your movie on the small TV sets. Thus, it is not necessary to make all the video connections. Just choose and make one of the video connections available on your TV or display device. Please note that the S-VIDEO and component VIDEO cables are not included in the package.

GETTING STARTED

Connecting to a TV Set with 2-Channel Audio Input

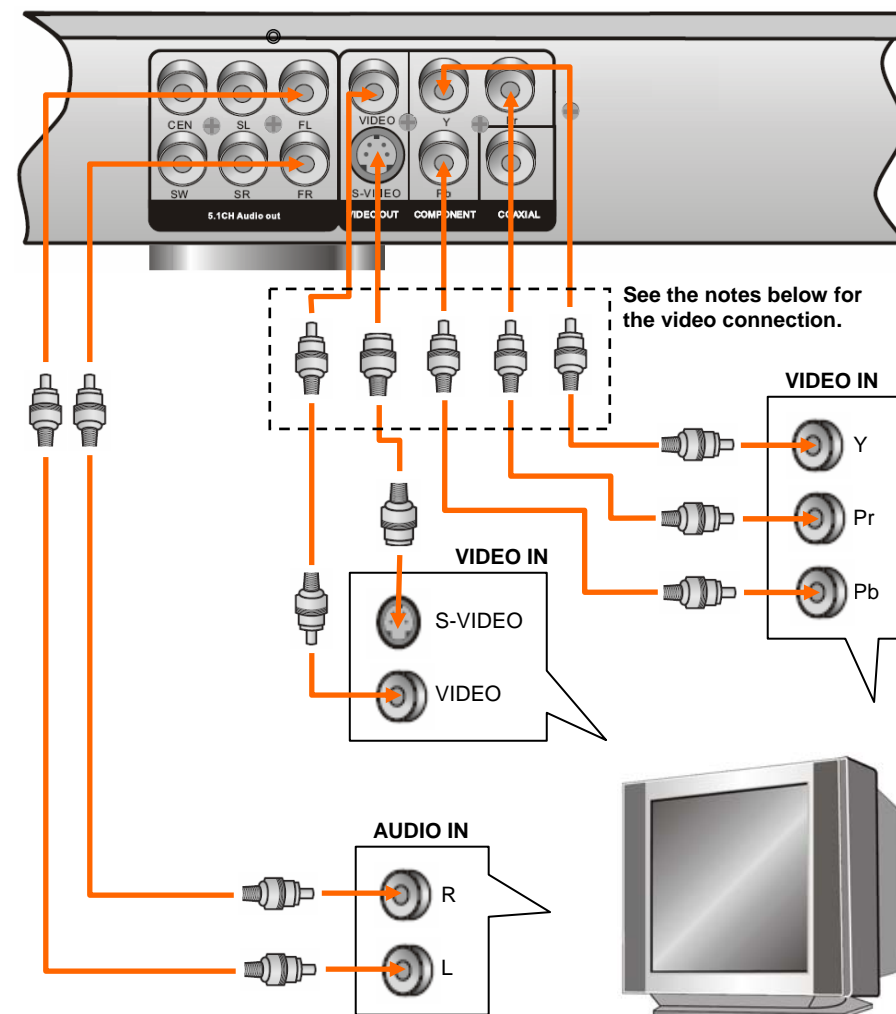

Notes on the Connection Diagram

1. You don't need to connect all the video outputs even though your TV set supports all the connections. Choose and make the most appropriate video connection available on your TV. The S-VIDEO and the component VIDEO cables aren't included in the package.
2. The component VIDEO output is labeled as Y, Pr (or Cr), and Pb (or Cb), and these three component video output jacks must be all and properly connected to properly display the picture in the component video mode of your TV set.

GETTING STARTED

Notes on the Connection Diagram – Continued

- After making the video connection of your choice, please ensure that your TV is in the proper mode as well. If you choose the component VIDEO connection, your TV must be in the component mode. If you choose the S-VIDEO connection, your TV must be in the S-VIDEO mode. Please refer to the user's manual of your TV for the detailed mode setting.
- Some TV sets use the different audio input for each video mode. Please refer to the user's manual of your TV for the detailed setting information.

Connecting to an Audio Amplifier with Digital Audio Input

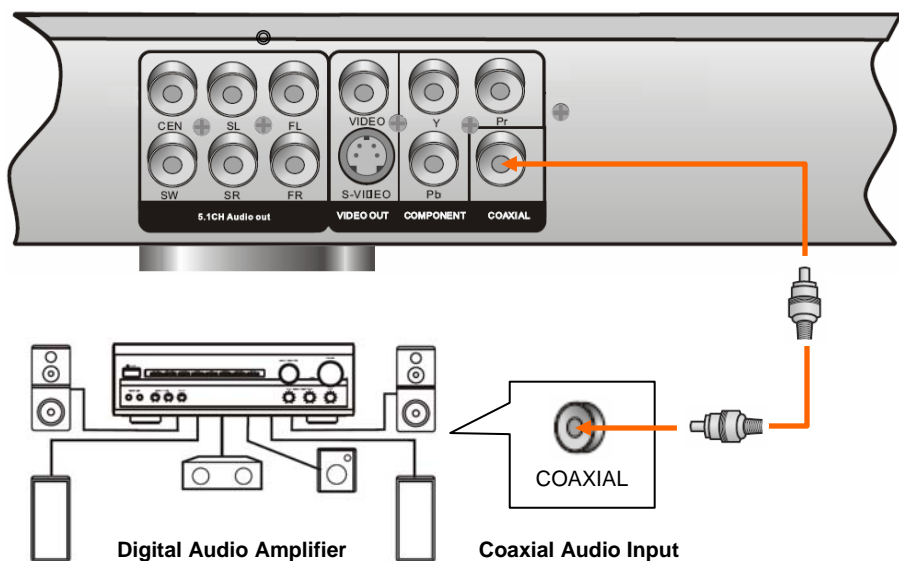

Notes on the Connection Diagram

Some audio amplifiers or TV sets support the coaxial digital audio input. If you have such an audio device, you can connect this unit to the device with the coaxial digital audio connection. The coaxial digital audio connection can allow a device to deliver the higher quality of audio to another audio device with the minimum loss. There are two options regarding to the coaxial digital audio connection. If your audio device has the capability of Dolby Digital decoding, this unit can send the digital audio contents in the RAW format to the audio device. The audio contents in the RAW format are the digital audio contents before decoding the digital audio contents. If your audio device doesn't have the capability of Dolby Digital decoding, this unit can also send the digital audio contents in the PCM format. The digital audio contents in the PCM format are the audio contents after decoding the audio content. Your audio device must be in the coaxial audio input mode. Please refer to the user's manual of your audio device for the detailed instructions. The coaxial digital audio cable is not included in the package.

GETTING STARTED

Connecting to a TV set and an Amplifier with 5.1-Channel Audio Input

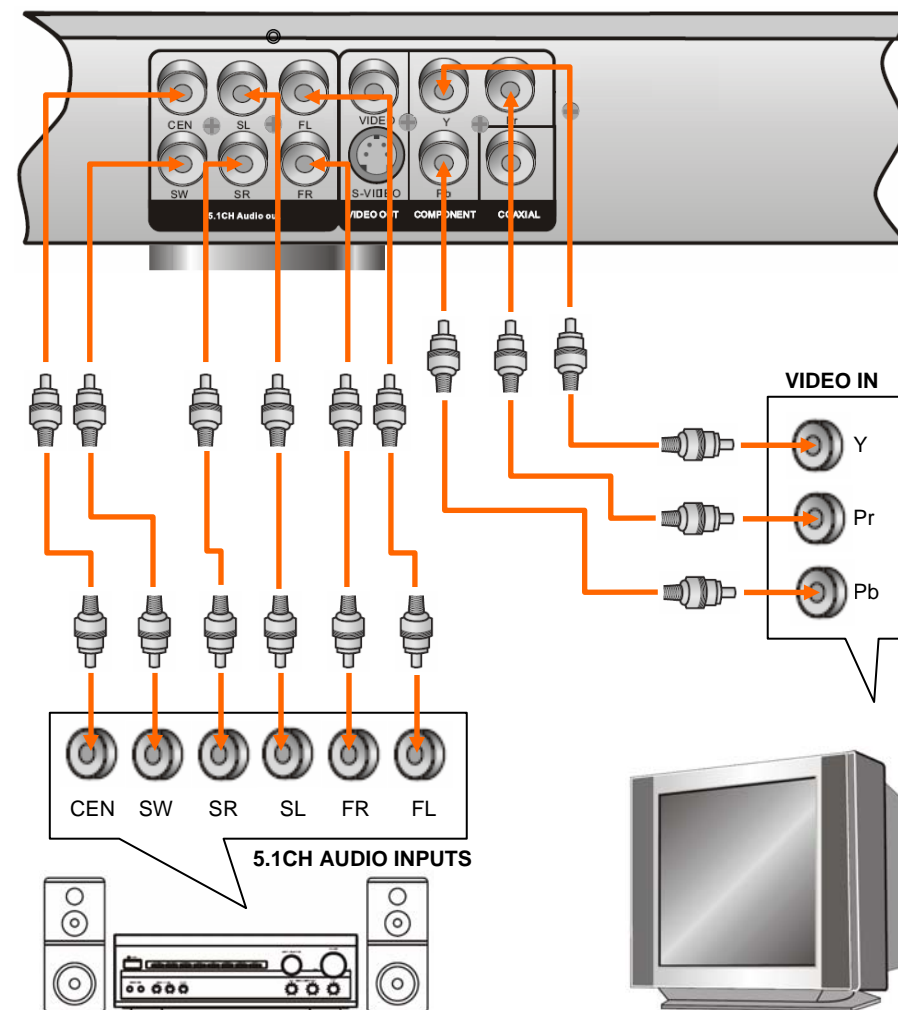

Notes on the Connection Diagram

- You can also use the composite VIDEO connection or S-VIDEO connection for the video display instead of the component VIDEO connection described on the connection diagram above. The component VIDEO and 5.1-channel audio cables aren't included in the package.
- Your TV set and 5.1-channel audio amplifier must be in the correct video or audio mode. Please refer to the user's manual of your TV and the 5.1-channel audio amplifier for the detailed installation instructions.

GETTING STARTED

Preparing the Unit and Attached Devices

After all the hardware connections are done, you can now connect the power cord of this unit and the attached devices. Please take a special caution while connecting the power cords to the outlet, and carefully read and follow the instructions in the user safety guide section in this manual while connecting power cords. After connecting the power cords, turn on this unit by pressing the [POWER] button on the main unit or the [STANDBY] button on the remote control. Also, turn on all the attached devices. This unit and all the attached devices must be appropriately set with the proper mode and channel settings based on your choice of connections. For the system setup of this unit, please read and follow the instructions below. For the system setup of the attached devices, please refer to their user's manual.

Navigating the Setup Menu

In the setup menu, there are 6 setup pages categorized as followings: **SYSTEM, LANGUAGE, AUDIO, VIDEO, SPEAKER, and DIGITAL**. Each setup page is composed of the several setup options corresponding to each category.

1. Turn on the main unit by pressing the [POWER] button on the main unit or [STANDBY] button on the remote control if it is off.
2. Press the [SETUP] button on the remote control. The setup menu will appear on your TV screen.
3. Use the [◀ / ▲ / ▼ / ▶] buttons and the [ENTER] button on the remote control to navigate the setup menu. For an example, if you want to set the brightness level in the video setup page, press the [▶] button to highlight the video icon, and then press the [▼] button to select the "BRIGHTNESS" option. After that, press the [ENTER] or [▶] button to confirm your selection. By now, you can see the setting values of the brightness. Using the [▲ / ▼] buttons, you can select the value you want and confirm the selected value by pressing the [ENTER] button.



4. Select the "EXIT SETUP" option using the [◀ / ▲ / ▼ / ▶] buttons, and then press the [ENTER] button to exit the setup menu. Or you can exit the setup menu by pressing the [SETUP] button.

GETTING STARTED

About the System Setup

The system setup menu is composed of the following setup options: **TV SYSTEM, SCREEN SAVER, VIDEO, TV TYPE, and DEFAULT**.

1. **TV SYSTEM:** Used to set the video output according to your TV system.
 - a. **AUTO:** When this option is selected, the video signal format will depend on the DVD recording format. If a DVD disc is recorded with the PAL TV format, this unit will automatically output the AV signal in the PAL format. To watch a movie correctly, your TV must support the PAL format. If a DVD disc is recorded with the NTSC TV format, this unit will automatically output the AV signal in the NTSC format. To watch a movie correctly, your TV must support the NTSC format.
 - b. **NTSC:** When this option is selected, the video signal format will no longer depend on the disc format. Regardless of the DVD recording type, this unit will output the AV signal in the NTSC format. To watch a movie correctly, your TV must support the NTSC format.
 - c. **PAL:** When this option is selected, the video signal format will no longer depend on the disc format. Regardless of the DVD recording type, this unit will output the AV signal in the PAL format. To watch a movie correctly, your TV must support the PAL format. There are several PAL types such as PAL-N, PAL-M, PAL-G, PAL-B, PAL-I, and so on. Thus, please check the technical specifications for which type of PAL your TV set supports. This unit supports PAL443 only.

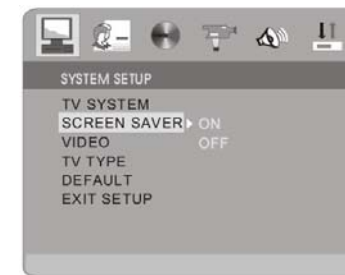

2. **SCREEN SAVER:** Used to protect the TV screen from the afterimage damage by the non-moving image.
 - a. **ON:** If it is set on, this unit will show the logo moving around on the screen when the system is idle for a certain time of period.
 - b. **OFF:** If it is set off, this unit will not enter the screen saver mode even if the system is idle for a long time.

GETTING STARTED

About the System Setup – Continued

3. **VIDEO:** Used to select the video format according to your choice of the video connection.
 - a. **INTERLACE-YUV:** Select this option if you made the component VIDEO connection between this unit and your TV, but your TV doesn't support the progressive-scan video format.
 - b. **P-SCAN YPBPR:** Select this option if you made the component VIDEO connection between this unit and your TV and your TV support the progressive-scan video format. Please note that if your TV doesn't support the progressive-scan video format, the video will not display on your TV correctly. Refer to the user's manual of your TV to check whether your TV supports the progressive-scan video format before selecting this option.
 - c. **S-VIDEO:** Select this option if you made the composite VIDEO connection or S-VIDEO connection between this unit and your TV.



4. **TV TYPE:** Used to set the movie aspect ratio according to the TV screen aspect ratio.
 - a. **4:3 PS:** Select this option when the aspect ratio of your TV screen is 4:3. When this option is selected, the displayed movie will retain the originally intended aspect ratio, but the image beyond the TV screen aspect ratio will be cut due to the TV screen size. One advantage of this setting is that you can see the movie with the full screen using the Pan-and-Scan technology.
 - b. **4:3 LB:** Select this option when the aspect ratio of your TV screen is 4:3. When this option is selected, the movie will be shown on the TV screen with the original movie aspect ratio, but the size of the displayed image will be reduced to fit into the TV screen. If the aspect ratio of the movie is 16:9, but the TV screen aspect ratio is 4:3, you will see the black bar on the top and on the bottom of the screen. One advantage of this option is that you can watch the movie without missing any portion of the image on the movie intended by a movie maker.
 - c. **16:9:** Select this option when your TV screen supports the screen aspect ratio of 16:9. If you select this option, the aspect ratio of the movie is 16:9, and the aspect ratio of your TV screen is 16:9, you can watch the movie on the full and wide screen without the black bar on the top and bottom of the TV screen and without any missing portion of images on the screen.

GETTING STARTED

About the System Setup – Continued

5. **DEFAULT:** Used to reset all the custom settings to the factory settings.
 - a. **RESTORE:** Select this option when you want to restore the factory settings. When you select this option, all your custom settings will be replaced by the factory default settings. This option also can be used when your unit doesn't seem to work properly.
6. **EXIT SETUP:** Used to exit the setup menu.



About the Language Setup

The language setup menu is composed of the following setup options: **OSD LANGUAGE**, **AUDIO LANG**, **SUBTITLE LANG**, and **MENU LANG**.

1. **OSD LANGUAGE:** Used to set the language for the On-Screen Display (OSD). This unit supports **ENGLISH**, **GERMAN**, **SPANISH**, **FRENCH**, **PORTUGUESE**, and **ITALIAN**.



2. **AUDIO LANG:** Used to select the audio language. The correct performance of this option depends on the audio contents supported by a DVD disc. If you select a language, which isn't supported by a DVD disc, this unit will use the default audio language of the DVD disc.
3. **SUBTITLE LANG:** Used to select the subtitle language. The correct performance of this option depends on the subtitle contents supported by a DVD disc. If you select a language, which isn't supported by a DVD disc, this unit will use the default subtitle language of the DVD disc.



GETTING STARTED

About the Language Setup – Continued

4. **MENU LANG:** Used to select the menu language of a DVD disc. The correct performance of this option depends on the menu language supported by a DVD disc. If you select a language, which isn't supported by a DVD disc, this unit will use the default subtitle language of the DVD disc.
5. **EXIT SETUP:** Used to exit the setup menu.



About the Audio Setup

The audio setup menu is composed of the following setup options: **AUDIO OUT**, **MIC SETUP**, **KEY**, **ECHO**, and **MIC VOL**.

1. **AUDIO OUT:** Used to turn on or off the S/PDIF feature. The word "S/PDIF" is short for "Sony / Phillips Digital Interface Format" and it is used to output the digital audio contents to the external audio device.
 - a. **SPDIF/OFF:** Select this option to turn off this S/PDIF. When it is selected, the digital output will be disabled.
 - b. **SPDIF/RAW:** Select this option to deliver the raw digital audio contents to the external audio device if the device has the capability of Dolby Digital decoding.
 - c. **SPDIF/PCM:** Select this option to deliver the digital audio contents in the PCM format to the external audio device if the device doesn't have the capability of Dolby Digital decoding but have the capability of PCM decoding.
2. **MIC SETUP:** When this option is set to "AUTO", this unit detects the installed microphone automatically and enables the microphone function.



3. **KEY:** Used to adjust the sound key (or tone).

GETTING STARTED

About the Audio Setup – Continued

4. **ECHO:** Used to adjust the echo level.



5. **MIC VOL:** Used to adjust the microphone volume level.
6. **EXIT SETUP:** Used to exit the setup menu.

About the Video Setup

The video setup menu is composed of the following setup options: **BRIGHTNESS**, **CONTRAST**, **HUE**, **SATURATION**, and **SHARPNESS**.

1. **BRIGHTNESS:** Used to adjust the brightness of a movie.



2. **CONTRAST:** Used to adjust the contrast of a movie.
3. **HUE:** Used to adjust the hue level of a movie.



GETTING STARTED

About the Video Setup – Continued

4. **SATURATION:** Used to adjust the color saturation of a movie



5. **SHARPNESS:** Used to adjust the sharpness of a movie
6. **EXIT SETUP:** Used to exit the setup menu.

About the Speaker Setup

The speaker setup menu is composed of the following setup options: **DOWNMIX**, **SUBWOOFER**, **CENTER DELAY**, **REAR DELAY**, and **BASS MODE**.

1. **DOWNMIX:** Used to set the sound characteristics based on the audio connection, which you made while installing this unit.
- LT / RT:** Select this option if you made the 2-channel audio connection.
 - STEREO:** Select this option if you made the 2-channel audio connection, especially to a TV set.
 - VSS:** Select this option if you made the 2-channel audio connection but want to listen to the soundtrack effects, down-mixed from the 5.1-channel surround sound, from the stereo audio speakers. The term “VSS” is short for “Virtual Surround Sound”.
 - 5.1 CH:** Select this option if you made the 5.1-channel audio connection.



2. **SUBWOOFER:** Used to turn on or off the sound channel for the subwoofer. If this unit is connected to a subwoofer, you can set this option on to enhance the bass sound.

GETTING STARTED

About the Speaker Setup – Continued

3. **CENTER DELAY:** Used to adjust the time delay of the sound output for the center speaker.



4. **REAR DELAY:** Used to adjust the time delay of the sound output for the rear speakers.
5. **BASS MODE:** Used to adjust the bass sound level by the installed speaker types and their arrangement.

- ALL LG SPK:** Select this option if all speakers are large.
- ALL SM SPK:** Select this option if all speakers are small.
- MIXED SPK:** Select this option if the installed speakers are mixed with the large and small sizes of speakers.



6. **EXIT SETUP:** Used to exit the setup menu.

About the Digital Setup

The digital setup menu is composed of the following setup options: **OP MODE**, **DYNAMIC RANGE**, and **DUAL MONO**.

1. **OP MODE:** Used to change the audio output level.
- LINE OUT:** Select this option to output the audio as a line-level sound signal. If the connected audio device has the direct AV input, it is better to select this option.
 - RF REMOD:** Select this option to output the audio sound with the higher sound level. This option is more suitable to connect this unit to a TV set, which doesn't have a direct AV input, in order to increase the sound level.



GETTING STARTED

About the Digital Setup – Continued

2. **DYNAMIC RANGE:** Used to lower the volume to avoid an annoying trembling sound without changing the original tone when the “**LINE OUT**” option is selected above.

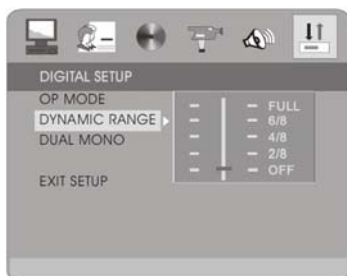

3. **DUAL MONO:** Used to select the way of the audio output when this unit is connected to a 2-channel audio device.
- STEREO:** Select this option to listen to a sound in the stereo format.
 - MONO L:** Select this option to listen to a sound such as the only left-channel mono sound
 - MONO R:** Select this option to listen to a sound as the only right-channel mono sound.
 - MIX MONO:** Select this option to listen to a sound as the mixed (left-and-right channel) mono sound.
4. **EXIT SETUP:** Used to exit the setup menu.

OPERATING WITH A REMOTE CONTROL

[STANDBY] Button

Press the [STANDBY] button to turn on this unit. The main unit must be connected to the power supply.

STANDBY



[0 – 9, 10+] Buttons

The [0 – 9, 10+] buttons are used to enter the time, title, chapter, or track number in a certain mode. For the number over 10, use the [10+] button with the single numeric buttons.

[OPEN/CLOSE] Button

To eject the disc tray, press the [OPEN/CLOSE] button. To close the disc tray, press the [OPEN/CLOSE] again.

OPEN /
CLOSE



[PLAY] Button

Press the [PLAY] button to play back a disc in the stop mode. Press the [PLAY] button to resume the playback in the pause mode.

PLAY



[PAUSE] Button

While playing back a DVD or CD disc, press the [PAUSE] button to pause. To resume the playback, press the [PLAY] button.

PAUSE



[STOP] Button

While playing back a DVD or CD disc, press the [STOP] button to stop the playback. It will remember the stop position until the disc is ejected, the [STOP] button is pressed once more, or the unit is turned off. To resume the playback at which you stopped, press the [PLAY] button. Press the [STOP] button twice in the playback mode to completely stop. This unit will not remember the stop position at this time.

STOP



[▶▶▶] Button

While playing back a DVD or CD disc, press the [▶▶▶] button to play back the video or audio contents fast forward. Each press will change the playback speed as follows:

FWD



▶▶X2 ⇒ ▶▶X4 ⇒ ▶▶X8 ⇒ ▶▶X20 ⇒ ▶▶X2

Press the [PLAY] button to resume the normal playback.

OPERATING WITH A REMOTE CONTROL

[◀◀] Button

While playing back a DVD or CD disc, press the [◀◀] button to play back the video or audio contents fast backward. Each press will change the playback speed as follows:

◀◀X2 ⇒ ◀◀X4 ⇒ ◀◀X8 ⇒ ◀◀X20 ⇒ ◀◀X2

Press the [PLAY] button to resume the normal playback.

REV



[|◀◀] Button

While playing back a DVD or CD disc, press the [|◀◀] button to skip to the previous chapter or track.

PREV



[▶▶] Button

While playing back a DVD or CD disc, press the [▶▶] button to skip to the next chapter or track.

NEXT



[MENU] Button

While playing back a DVD disc, press the [MENU] button to return to the disc menu screen. This function depends on the disc type.

MENU

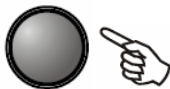

[A – B] Button

While playing back a DVD disc, press the [A – B] button to select Point A, and then, after some time later, press it again to select Point B. This unit will play the section from A to B repeatedly. Press the [A – B] button again to clear the memorized point and cancel this function.

A – B

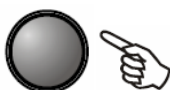

Note: While playing back a CD disc, both Point A and Point B must be within the same track. During the DVD playback, Point A and Point B can be selected from different chapters. This function depends on the disc type.

[SLOW] Button

Press the [SLOW] button to play back the video or audio contents slowly. Each press will change the playback speed as follows:

SLOW



Normal Playback ⇒ 1/2 ⇒ 1/3 ⇒ 1/4 ⇒ 1/5 ⇒ 1/6 ⇒ 1/7 ⇒ Normal Playback

OPERATING WITH A REMOTE CONTROL

[RETURN] Button

While playing back a DVD disc or VCD2.0 disc with the PBC menu, press the [RETURN] button to return to the menu screen.

RETURN



[TITLE] Button

While playing back a DVD disc, press the [TITLE] button to display the DVD title menu or play back the first title when the DVD disc doesn't support the title menu. This function depends on the disc type.

TITLE



[REPEAT] Button

While playing back a DVD or CD disc, press the [REPEAT] button to set this unit to repeatedly play back a single track, a single chapter, a single title, or a whole disc. Each press will change the repeating option. To turn off the repeat function, press the [REPEAT] button until you see the indication "REPEAT OFF" on the screen.

REPEAT



[VOL] Buttons

Press the [VOL +] button to increase the volume. Press the [VOL -] button to decrease the volume.

VOL



[MUTE] Button

Press the [MUTE] button to mute the audio output. To resume the normal audio output, press the [MUTE] button again.

MUTE



[ZOOM] Button

While playing back a DVD disc, press the [ZOOM] button to zoom in or out the image. Each press will change the zooming ratio as follows:

ZOOM



ZOOM 2 ⇒ ZOOM 3 ⇒ ZOOM 4 ⇒ ZOOM 1/2 ⇒ ZOOM 1/3 ⇒ ZOOM 1/4 ⇒ ZOOM OFF
(Normal Playback)

[ANGLE] Button

While playing back a DVD disc, press the [ANGLE] button to view the scenes from the different camera angles. To go back to the normal playback, press the [ANGLE] button repeatedly until the angle function is turned off. A DVD disc must support the different angle view to activate this function.

ANGLE



OPERATING WITH A REMOTE CONTROL

[LANGUAGE] Button

While playing back a DVD disc, press the [LANGUAGE] button to select an audio language or format. This function depends on a DVD disc.

LANGUAGE



[SUBTITLE] Button

While playing back a DVD disc, press the [SUBTITLE] button to turn on the subtitle and to select the language for the subtitle. This function depends on a DVD disc.

SUBTITLE



[P/N] Button

Press the [P/N] button to select the video signal format for your TV. Each press will change the video signal format as follows: **PAL**, **AUTO**, and **NTSC**. If you select a wrong video signal format, press the [P/N] button repeatedly until the image is displayed correctly on your TV screen.

P/N



[DIGEST] Button

While playing back a VCD disc, press the [DIGEST] button to watch video tracks or segments in the thumbnail viewing mode. This function works only with a VCD in the "PBC OFF" mode.

DIGEST

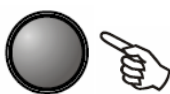

[MODE] Button

Press the [MODE] button to change the video output format. This unit supports 3 different video output formats: **Interlaced Video Output**, **Progressive-scan Video Output**, and **S-VIDEO** output. If you select a wrong video output by a mistake, press the [MODE] button repeatedly until the TV screen shows correctly.

MODE

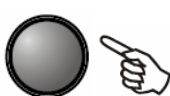

[PBC] Button

This button is used to control the playback of a VCD2.0 or SVCD disc. Press the [PBC] button to de-activate this function. Press it again to activate this function.

PBC

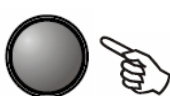

[PSCAN/NORMAL] Button

Press the [PSCAN/NORMAL] button to change from the interlaced video output to the progressive video output or vice versa. For the progressive scan mode, this unit must be connected to your TV with the component video cable.

PSCAN /
NORMAL

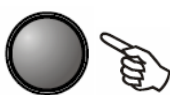

OPERATING WITH A REMOTE CONTROL

[DISPLAY] Button

While playing a DVD disc, press the [DISPLAY] button once to see the playback information. This function depends on the disc type.

DISPLAY



Press the [DISPLAY] button again to see other additional information.



[TIME] Button

While playing back a DVD disc, press the [TIME] button once to see the playback time information. This function depends on the disc type.

TIME



OPERATING WITH A REMOTE CONTROL

[TIME] Button – Continued

Press the [TIME] button again to see the remaining playback time.



[GOTO] Button

While playing back a DVD disc, press the [GOTO] button to skip to a certain point in the movie. In this mode, you can skip directly to a certain title, chapter, or time. To select the chapter, title, or time field in the information bar on the top of the screen, use the [◀] or [▶] button. After selecting the chapter, title, or time position, enter the title number, chapter number or time, where you wish to skip, by using the numeric buttons [0 – 9, 10+]. Then, press the [ENTER] button to confirm your input. The function of this button depends on the disc type.

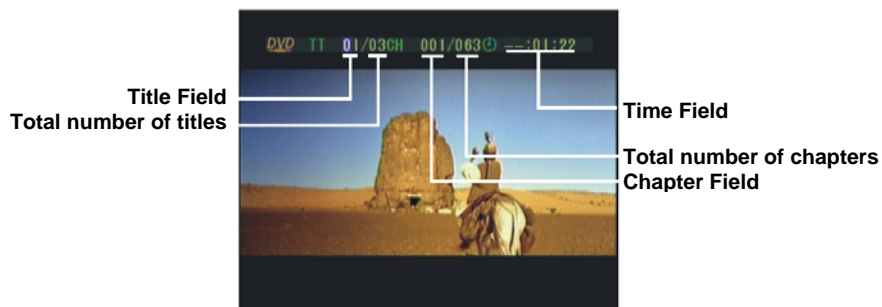

[L/R] Button

While playing back a SVCD, VCD, or CD disc, press the [L/R] button to set the audio format. You can set the audio format to one of the following options: **Stereo**, **Mono L**, **Mono R**, and **Mixed Mono**.

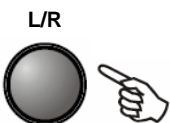

OPERATING WITH A REMOTE CONTROL

[RANDOM] Button

Press the [RANDOM] button to play back video or audio contents in the random order.



[SETUP] Button

Press the [SETUP] button to enter the setup mode. In the setup mode, you can set up the general system settings, video setting, audio settings, language settings, and speaker settings.

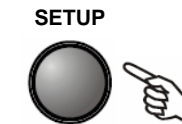

[PROG] Button

Using this button, you can program the tracks and chapters in your desired order. While playing back a DVD or CD disc, press the [PROG] button to enter to the program mode. The program submenu will appear on your TV screen. You can set the program list up to 16 tracks or chapters.

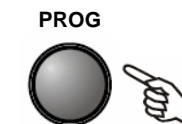

- **For CD, VCD, or SVCD**

Input the track number in the preferred order up to 16 tracks using the numeric buttons [0 – 9] buttons and [10+] button. To clear all the programmed tracks, select the "Clear" option, using the [◀ / ▲ / ▼ / ▶] buttons. Then, press the [ENTER] button. When you finish programming, select the "Play" option, using the [◀ / ▲ / ▼ / ▶] buttons. Then, press the [ENTER] button to start the playback.

- **For DVD**

Input the title number and chapter number in the preferred order up to 16 chapters using the numeric buttons [0 – 9] buttons and [10+] button. To clear all the programmed chapters, select the "Clear" option, using the [◀ / ▲ / ▼ / ▶] buttons. Then, press the [ENTER] button. When you finish programming, select the "Play" option, using the [◀ / ▲ / ▼ / ▶] buttons. Then, press the [ENTER] button to start the playback.

ADVANCED FEATURES

Playing MP3 CDs

When a MP3 CD is loaded, you will see the special screen for the MP3 file display as below:

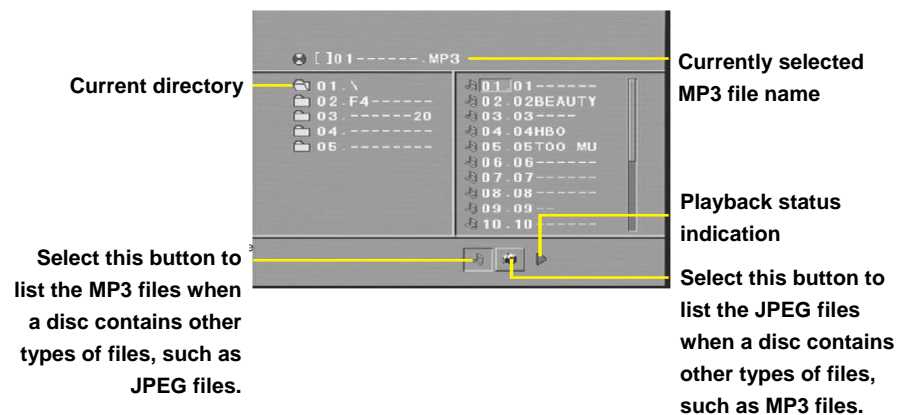

Use the [◀, ▲, ▼, ▶] buttons to select a MP3 file when the cursor appears in the file window. Then, press the [PLAY] or [ENTER] button to play back the selected file.

Notes: The unit might not function correctly under the following conditions:

1. The loaded disc is badly scratched, damaged or dirty.
2. The disc isn't finalized.
3. The recording format is not supported by this unit.

Using the Microphones

1. Insert your microphone to the microphone jack on the front panel of this unit.
2. Load the DVD or VCD disc.
3. Press the [L/R] button on the remote control to select the right or left channel.
4. Play and enjoy your song with your microphones.

About Kodak Picture CDs

A Kodak Picture CD has the same size as a regular audio CD, and it can be ordered at the photo shop where provides a service to make a Kodak Picture CD for you.

Notes: This unit supports up to the resolution of 3840 x 3840.

CARE AND MAINTENANCE GUIDES

Handling a Disc

- Treat the disc carefully. Handle the disc only by its edges. Never allow your fingers to contact with the shiny, unprinted side of the disc.
- Do not attach adhesive tape, stickers etc., to the disc label.
- Clean the disc periodically with soft, lint-free, dry cloth. Never use detergents or adhesive cleaners to clean the disc. If necessary, use a CD or DVD cleaning kit.
- If disc skips or gets stuck on a section of the disc, it is probably dirty or damaged (scratched).
- When cleaning the disc, wipe in straight lines from the centre of the disc to the edge of the disc. Never wipe in circular motions.
- To remove a disc from its storage case, press down on the centre of the case and lift the disc out, holding it carefully by the edges.
- Fingerprints and dust should be carefully wiped off the disc's recorded surface with a soft cloth. Unlike conventional records, compact disc have no groove to collect dust and microscopic debris, so gently wiping with a soft cloth should remove most particles.



Cleaning the Unit

- To prevent fire or shock hazard, disconnect your unit from the AC power source when cleaning.
- The finish on the unit may be cleaned with a dust cloth and cared for as other furniture. Use caution when cleaning and wiping the plastic parts.
- If the cabinets become dusty wipe them with a soft dry dust cloth. Do not use any wax or polish sprays on the cabinets.
- If the front panel becomes dirty or smudged with fingerprints it may be cleaned with a soft cloth slightly dampened with a mild soap and water solution. Never use abrasive cloths or polishes as these will damage the finish of your unit.

Caution: never allow any water or other liquids to get inside the unit while cleaning.

TROUBLESHOOTING GUIDE**No picture or no sound**

- Ensure whether the [POWER] button on the front panel is on.
- Ensure whether the power cord is connected properly.
- Ensure the power outlet is working.

Picture but no sound

- Ensure the audio jacks are securely connected.
- Ensure the volume is turned up to the proper level.
- Ensure you have set the AUDIO settings correctly.
- Ensure you have connected the audio cable properly.
- Ensure the audio is not set to mute.

Sound but no picture

- Ensure the video jacks are securely connected.
- Ensure you have connected the video cable properly.
- Ensure you have set the VIDEO settings correctly.

Poor picture or poor sound

- Ensure you have set the AUDIO and VIDEO settings correctly.
- Ensure the disc is not scratched or stained.

The “Bad Disc” indication is displayed.

- Ensure the disc is not warped, damaged or deformed.
- Ensure the disc is not badly stained or damaged.
- Ensure the disc format is compatible with the player.

The remote control isn't working.

- Make sure the [POWER] button on the main unit is set on.
- Point the remote control directly at the remote control sensor on the main unit.
- Remove any obstacles between the remote control and the remote control sensor.
- Change the remote control batteries.

The “No Disc” indication is displayed.

- Ensure you have loaded a disc.
- Ensure the disc is not upside down.
- Ensure the disc isn't distorted, stained or scratched.

The main unit is not working.

- Power off the main unit and turn it on again.

SPECIFICATIONS**General Specifications**

- Power Requirements: AC: 100V-240V, 60Hz/50Hz
- Power Consumption: 15W
- Signal System: NTSC / PAL
- Frequency Response: 20Hz – 20kHz
- S/N Ratio: < 90dB
- Total Harmonic Distortion: < 0.0025%
- Unit Weight: 1.93kg (4.3 lbs)

Connectivity

- Video
 - Composite Video Output
 - S-VIDEO Output
 - Component Video Output (Y, Pb, Pr)
- Audio
 - 5.1-Channel Audio Output (can be used as 2-Channel Audio Output)
 - Coaxial Digital Audio Output
 - Microphone Jacks x 2

* Specifications and features are subject to change without the prior notice. The weight and dimensions are approximate.

jWIN

TEL: 516-626-7188

FAX: 516-626-7105

website: www.jWIN.com

© 2006 jWIN Electronics Corp. All rights reserved. No portion of this printing material or product enclosed herewith including design, shape and graphics, may be not reproduced or transmitted in any form without the expressed written consent of jWIN Electronics Corp. by any means, electronics or mechanical, including photocopy, recording or information storage and retrieval system. Any unauthorized distribution or reproduction of this printing material or product, or any portion there of, will be prosecuted to the fullest possible extent of the law.

Free Manuals Download Website

<http://myh66.com>

<http://usermanuals.us>

<http://www.somanuals.com>

<http://www.4manuals.cc>

<http://www.manual-lib.com>

<http://www.404manual.com>

<http://www.luxmanual.com>

<http://aubethermostatmanual.com>

Golf course search by state

<http://golfingnear.com>

Email search by domain

<http://emailbydomain.com>

Auto manuals search

<http://auto.somanuals.com>

TV manuals search

<http://tv.somanuals.com>