

jWIN[®]

VERTICAL CD PLAYER with MP3 DIGITAL RADIO

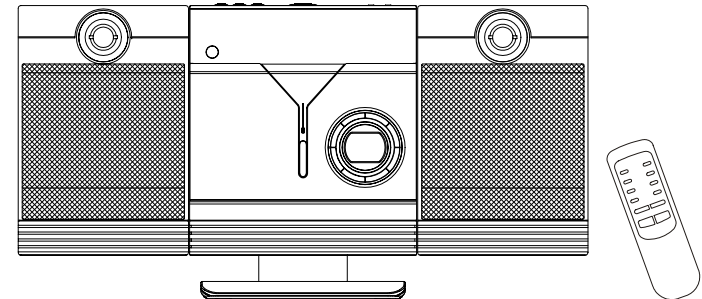



OWNER'S MANUAL MODEL JX-CD5500

Visit our Web Site: <http://www.jwin.com>

IMPORTANT SAFETY INSTRUCTIONS

WARNING:

TO PREVENT FIRE OR SHOCK HAZARD, DO NOT USE THIS PLUG WITH AN EXTENSION CORD, RECEPTACLE OR OTHER OUTLET UNLESS THE BLADES CAN BE FULLY INSERTED TO PREVENT BLADE EXPOSURE. TO PREVENT FIRE OR SHOCK HAZARD. DO NOT EXPOSE THIS APPLIANCE TO RAIN OR MOISTURE.

 <p>This lightning flash with arrowhead symbol, within an equilateral triangle, is intended to alert the user to the presence of uninsulated "dangerous voltage" within the product's enclosure that may be of sufficient magnitude to constitute a risk of electric shock persons.</p>	<p>CAUTION RISK OF ELECTRIC SHOCK DO NOT OPEN</p> <p>Warning: to reduce the risk of electric shock, do not remove cover (or back) no user-serviceable parts inside. Refer servicing to qualified service personnel.</p>	 <p>The exclamation point within an equilateral triangle is intended to alert the user to the presence of important operating and maintenance (servicing) instructions in the literature accompanying the appliance.</p>
--	--	---

1. Read these instructions.
2. Keep these instructions.
3. Heed all warnings.
4. Follow all instructions.
5. Do not use this apparatus near water.
6. Clean only with dry cloth.
7. Do not block any ventilation openings. Install in accordance with the manufacturer's instructions.
8. Do not install near any heat sources such as radiators, heat registers, stoves, or other apparatus (including amplifiers) that produce heat.
9. Do not defeat the safety purpose of the polarized or grounding type plug. A polarized plug has two blades with one wider than the other. A grounding type plug has two blades and a third grounding prong. The wide blade or the third prong are provided for your safety. If the provided plug does not fit into your outlet, consult an electrician for replacement of the obsolete outlet.
10. Protect the power cord from being walked on or pinched particularly at the plugs, convenience receptacles, and at the point where they exit from the apparatus.
11. Only use attachments/accessories specified by the manufacturer.
12. Unplug the apparatus during lightning storms or when unused for long periods of time.
13. Refer all servicing to qualified personnel. Servicing is required when the apparatus has been damaged in any way, such as power supply cord or plug is damaged, liquid has been spilled or objects have fallen into the apparatus, the apparatus has been exposed to rain or moisture, does not operate normally, or has been dropped.
14. This appliance shall not be exposed to dripping or splashing water and objects filled with liquids such as vases must not be placed on apparatus.

CAUTION: TO PREVENT ELECTRICAL SHOCK, MATCH WIDE BLADE PLUG TO WIDE SLOT AND FULLY INSERT.

PRECAUTIONS

CAUTION:

- To avoid electric shock, this unit must not be exposed to dripping or splashing water
- Minimum distances around the apparatus for sufficient ventilation;
- The ventilation should not be impeded by covering the ventilation openings with items, such as newspapers, table-cloths curtains, etc.
- No naked flame sources, such as lighted candles, should be placed on the apparatus;
- Before scrapping the appliance, remove the batteries and place them in the appropriate battery collection container.

<p>CAUTION CLASS 1 LASER PRODUCT</p> <p>Use of Controls or adjustments or performance of procedures other than those specified herein may result in hazardous radiation exposure.</p> <div data-bbox="1310 598 1568 710" style="border: 2px solid black; padding: 5px; text-align: center;"> <p>CLASS 1 LASER PRODUCT LUOKAN 1 LASERLAITE KLASS 1 LASERAPPARAT</p> </div> <p>CAUTION CLEANING: Always disconnect unit from power supply before attempting to clean it. Use soft cloth moistened with soapy water, wipe gently. Do not use solvents or abrasive materials.</p>	<p>LASER SAFETY</p> <p>This unit employs a laser. Only qualified service personnel should attempt repair.</p> <div data-bbox="1680 558 1792 678" style="text-align: center;"> </div> <p>DANGER: INVISIBLE LASER RADIATION WHEN OPEN AND INTERLOCK FAILED OR DEFEATED. AVOID DIRECT EXPOSURE TO BEAM. CAUTION: HAZARDOUS LASER RADIATION WHEN OPEN AND INTERLOCK DEFEATED.</p>
--	--

INSTALLATION

PEDESTAL INSTALLATION

1. Set the unit on the pedestal (1).
2. To fix the insert, then fix it by 2 pcs screws as (2).

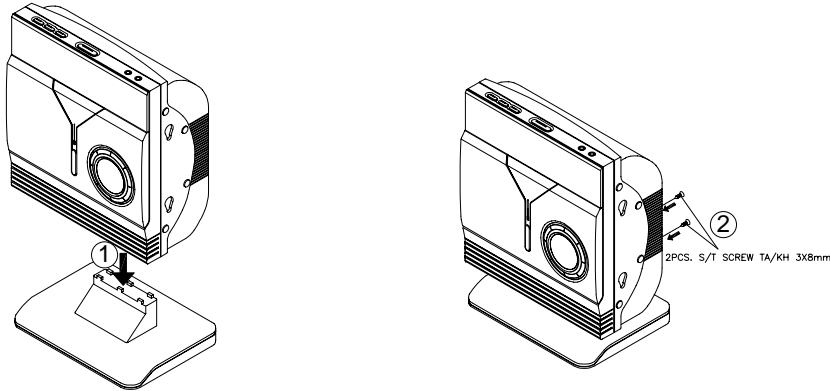

PLACE AND FIX THE SPEAKER

- Insert the speaker stud into the hole of the main unit as (1).
- Push the speaker down to the end until click sound is heard to confirm fixed as (2).

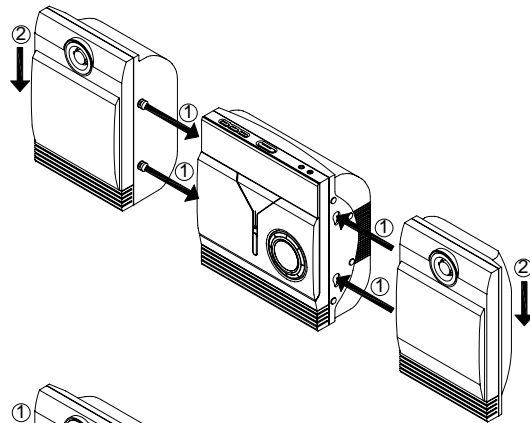

DISASSEMBLE THE SPEAKER

- Pushing the speaker up from the back side as (1).
- Release the speaker from the main unit speaker holder as (2).

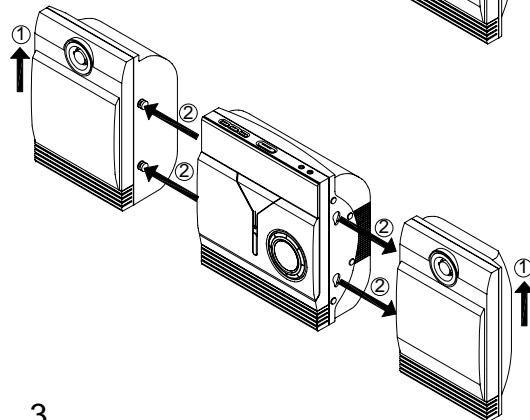

3

INSTALLATION (Wall Mounting)

- Position the bracket (supplied) on the wall (as show below) where you want to hang the center unit. Drill 2 holes slightly undersized for a firm fit.
- Secure the bracket on the wall using 2 dowels and 2 screws (supplied)
- The mounting screws are to be anchored into solid wall support, such as wood frame or concrete wall.
Mount the center unit onto the wall bracket.
- Make sure the mounting tab on the center unit fits securely into the mounting slot on the wall bracket.
- Screws and plastic dowels are also provided for speakers if they are to be wall-mounted away from the center section.

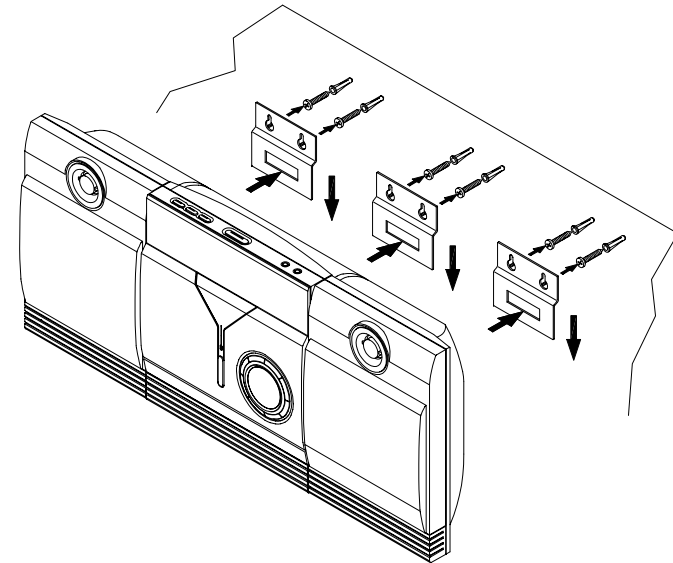

4

LOCATION OF CONTROLS

TOP VIEW

1. POWER Button
2. EQ Button
3. FUNCTION Button
4. CD Door Open/Close Button
5. FOLDER DOWN/MEM. DOWN Button
6. FOLDER UP/MEM. UP Button

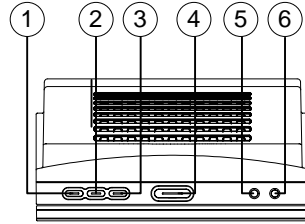

FRONT VIEW

7. REMOTE Sensor
8. CD Door
9. STANDBY Indicator
10. PLAY MODE Button
11. STOP/BAND Button
12. CD/TUNER LCD Display
13. PLAY/PAUSE Button
14. VOLUME UP/DOWN Button
15. TUNING/CD SKIP UP/Next and DN/Back Button
16. PROGRAM Button
17. PEDESTAL

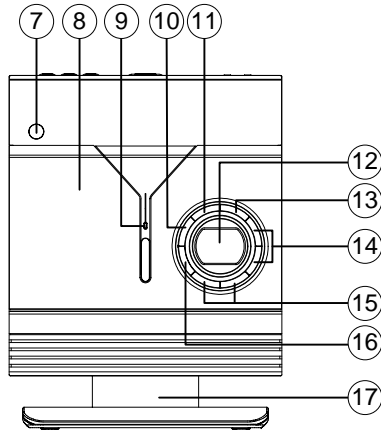

REAR VIEW

18. SPEAKER Terminal
19. AC Input Socket
20. SUBWOOFER Jack
To connect with external sub-woofer speaker (not included)
21. HEADPHONE Jack (3.5mm)
22. FM Antenna
23. AUX Socket (R)
24. AUX Socket (L)
25. BATTERY Door/Compartment
26. RESET Switch - If the set locked up, or does not display information, or the data appearing are wrong, press the "RESET" switch with a sharp object, e.g. needle etc. The data must then be re-entered.
Note: Tuner memory would be lost when "RESET" switch pressed.
27. FM STEREO/MONO Switch

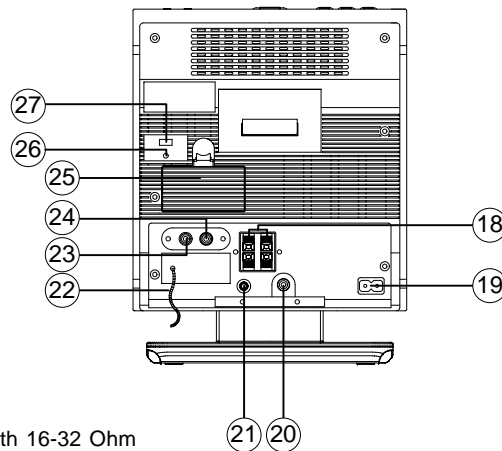

Headphone Jack

Headphone Jack "PHONES" (21) for headphones with 16-32 Ohm impedance (3.5mm jack). Use corresponding adaptors (Electronics shops) if you have different plugs. The speakers are automatically switched off when the headphones are being used.

CAUTION:

Listening at high power for long hours can damage users' ears.

REMOTE CONTROL

28. FOLDER DN/MEM-DN Button
29. ■ CD STOP/BAND Button
30. PLAY MODE Button
31. POWER Button
32. FUNCTION Button
33. TUNING/CD SKIP ►► / ◀◀ Buttons
34. PROGRAM Button
35. ►|| CD PLAY/PAUSE Button
36. FOLDER UP/MEM-UP Button
37. VOLUME UP/DOWN Button

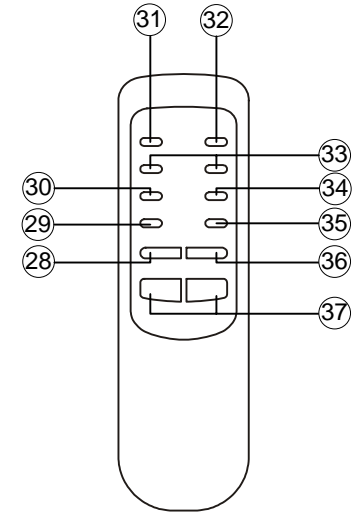

BATTERY REPLACEMENT

1. Remove the battery compartment cover.
2. Insert two "AA" size / LR6 / UM-3 batteries into the battery compartment and ensure the proper polarities are maintained.
3. Replace the battery compartment cover.

Battery Life

- To prevent damage due to batteries leaking, the remote should be checked periodically as required.
- Damage due to battery leakage is not covered by the warranty.
- When the battery becomes weak, the remote control will not work, be sure to replace both batteries at the same time. We recommend ALKALINE batteries for longer usable life.

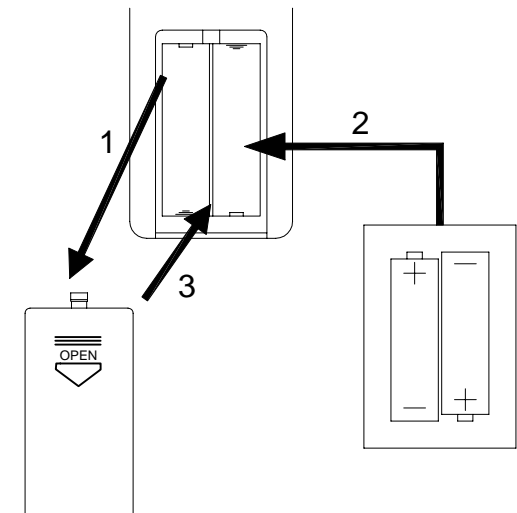

OPERATING INSTRUCTION

POWER ON/OFF

1. Connect the AC cord, make sure the voltage is correct and then press the POWER button (1) or (31) to turn on the unit.
2. Press the FUNCTION button (3) or (32) to select your desired mode (CD/AUX/TUNER).
3. Press the POWER button (1) or (31) to turn off the unit.

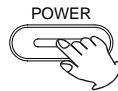
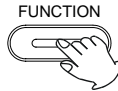
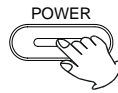

BASIC OPERATION

Volume Control

Once the required mode has been located, adjust the VOLUME button (14) or (37) up or down to the desired level.

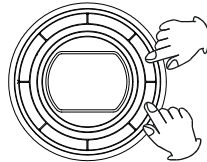

Preset Equalization

To select desired sound effect, press the EQ button (2) repeatedly to cycle through the preset EQ show on the display — CLA (Classic), ROCK, POP.

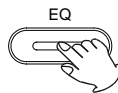

FM Stereo/Mono

Slide the FM Stereo/Mono switch (27) to choose between FM stereo (2-channel) reception or FM mono (1-channel) reception. If the FM stereo reception is too noisy, choose the FM mono reception setting instead.

AUX Operation

To listen to audio signals from an external unit through this unit.

1. Connect the right (23) and left (24) plugs from the auxiliary unit.
2. Press the FUNCTION button (3) or (32) select to AUX mode.
3. Operate the auxiliary unit by following it's owners manual.

LISTENING TO THE RADIO

1. Press the POWER button (1) or (31) to turn on the unit then press the FUNCTION button (3) or (32) to select RADIO mode.

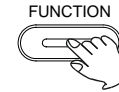

2. Press the STOP/BAND button (11) or (29) for AM or FM band.

Example : FM mode



3. Press the TUNING Up or Down button (15) or (33) to tune to the desired station.

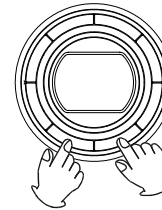

Manual Tuning - Press and hold the TUNING UP or DOWN buttons (15) or (33) until the display approaches your desired station. Then tap the buttons repeatedly until the display shows the exact frequency.

Auto tuning - Press the TUNING UP or DOWN buttons momentarily and release. The tuner will move up or down to the next available station.

4. When finished listening, press the POWER button (1) or (31) to turn off the unit.

STORING PRESET STATIONS

1. Tune to the station you wish to store by pressing TUNING UP or DOWN button (15) or (33).

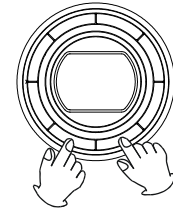

The unit enables you to program 10 stations of FM and 10 stations of AM band.

2. Press the PROGRAM button (16) or (34). ("MEM" flashing)

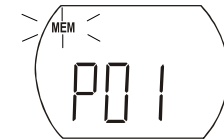

3. Press the FOLDER UP or FOLDER DOWN button (5)/(6) or (28)/(36) repeatedly to set the desired preset station number. ("MEM" still flashing)

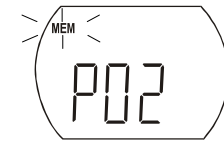

4. Press the PROGRAM button (16) or (34). The station is stored. ("MEM" steady on)



5. To store other stations, repeat above steps.

RECALLING PRESET STATION

Press the FOLDER UP or FOLDER DOWN button (5)/(6) or (28)/(36) on main unit or remote control repeatedly to select the desired station.

PLAYING COMPACT DISCS

1. Press the POWER button (1) or (31) turn on the unit then press the FUNCTION button (3) or (32) to select CD mode.

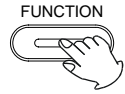

2. If there is no CD inside or disc damaged, a "- - -" display will appear.

When there is no disc

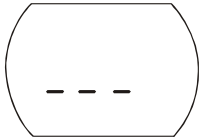

Loading a disc

1. Press the CD door Open button (4) to open the CD door.
2. Put a disc inside and then close the CD door. After that, reading disc will start.

Note: Ensure the disc is pushed fully and locked in place.

After reading disc



Note: This unit is CD-R / -RW compatible.

To play the disc

Press the PLAY/PAUSE button (13) or (35) to play the CD.

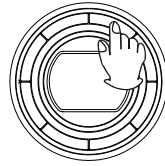

Playing track 1

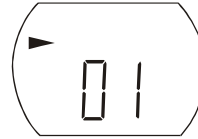

To pause the CD

Press the PLAY/PAUSE button while the disc is playing. Press it again to resume playing.

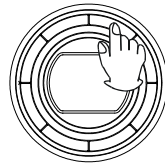

While paused

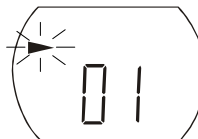

To stop the disc

Press the STOP button (11) or (29).

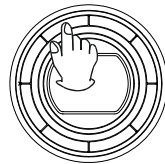

Stop condition (Total track display)



Skip and Search Function

Press the SKIP Next or Back buttons (15) or (33) briefly.

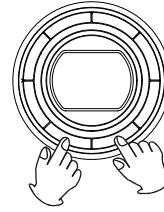

	IN PLAY MODE		IN STOP MODE
	PRESS ONCE	PRESS TWICE	PRESS ONCE
	BACK TO THE BEGINNING OF THE CURRENT TRACK	PREVIOUS TRACK	PREVIOUS TRACK
	NEXT TRACK		NEXT TRACK

Press and hold the SKIP button during playback :



: FAST BACKWARD



: FAST FORWARD

NOTE : During search mode low level audio will be heard to assist in locating the correct point in the track.

To repeat a track or disc

Press the PLAY MODE button (10) or (30) one time, "one track repeat" will be active. ("REP" flashes)

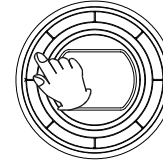

One track repeat (flashing)



With one more press, "all track repeat" will be active. ("REP A" will show steadily)

With one additional press, the repeat mode is cancelled.

All track repeat (steady)

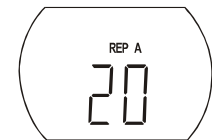
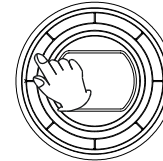

Random play function

In CD stop mode, press the PLAY MODE button (10) or (30) on main unit or remote control three times ("RAND" displayed), then press PLAY/PAUSE button (13) or (35) to start random play. Press PLAY MODE button (10) or (30) once again to change normal playing mode.

Random playing start

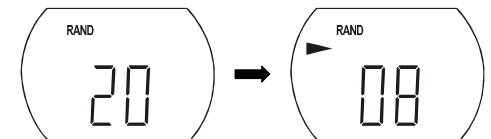

PROGRAMMED PLAYBACK

This CD player enables you to program up to 20 tracks in the sequence of your choice. First select CD stop mode.

1. Press the PROGRAM button (16) or (34) one time. ("MEM" flashes)

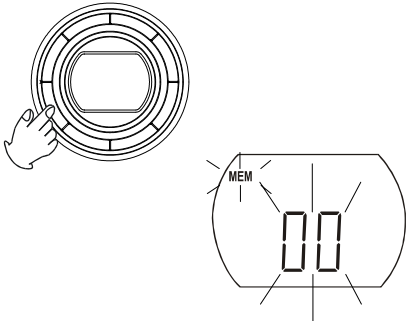

2. Press the SKIP Next or Back buttons (15) or (33) to select the desired track to be programmed.

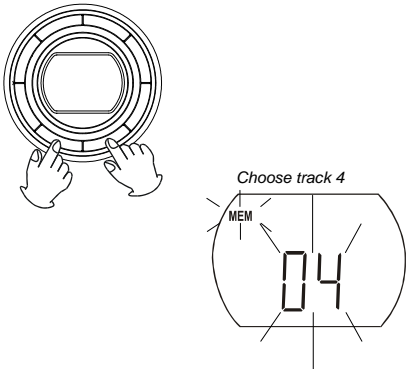

3. Press the PROGRAM button (16) or (34) one time, then the selected track, e.g., track 4 is stored.

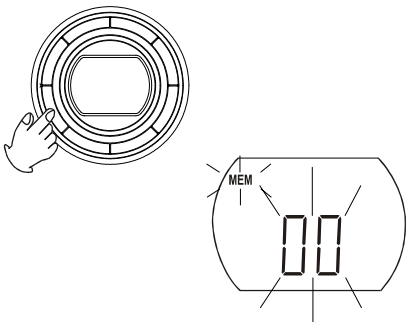

4. To continue to program, repeat steps 2 and 3 for each selection.

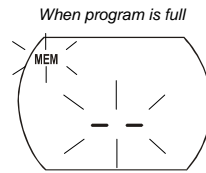

Reviewing programs

Press the PROGRAM button (16) or (34) repeatedly. The track number programmed on each program number will be displayed.

5. Press PLAY/PAUSE button (13) or (35) to play the programmed tracks.

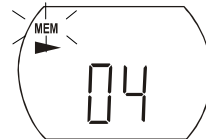

Clear the program

Press the PROGRAM button (16) or (34) to recall previously programmed track ("MEMORY" icon flashes), then press CD stop button to cancel the preset programs or change function mode or open the CD door.

PLAYING MP3 DISCS

1. Press the POWER button (1) or (31) to turn on the unit then press the FUNCTION button (3) or (32) to select CD mode.

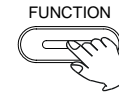

2. If there is no disc inside or disc damaged, a "- - -" display will appear.

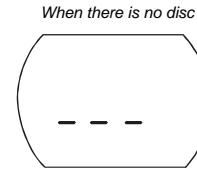

Loading a disc

1. Press the CD Door Open button (4) to open the CD door.
2. Put a disc inside and then close the CD door. After that, reading disc will start.

Note: Ensure the disc is pushed fully and locked in place.

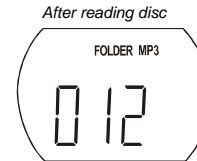

Note: This unit is CD-R / -RW compatible.

To play the disc

1. Press the FOLDER UP or FOLDER DOWN button (5)/(6) or (28)/(36) to select desired folder. Total tracks of select folder will then be shown.

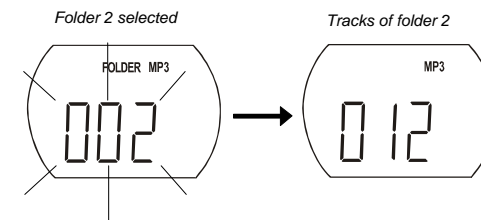

2. Press CD SKIP ►► / ◀◀ buttons (15) or (33) to select desired track.

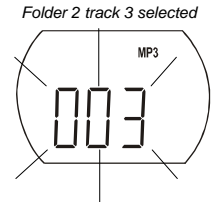
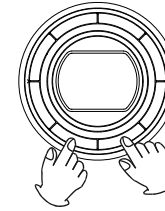

3. Press the PLAY/PAUSE button (13) or (35) to start playing.

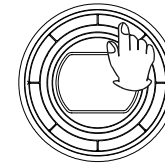

To pause the MP3

Press the PLAY/PAUSE button (13) or (35) while the disc is playing. Press it again to resume playing.

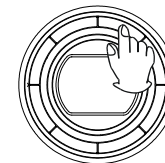

To stop the disc playing

Press STOP button (11) or (29).



Stop condition (TOC display)

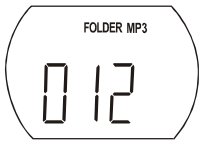

PLAY MODE for Repeat Track/Folder and Random Play Operation

1. Press the PLAY MODE button (10) or (30) once for current track repeat.

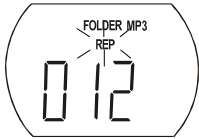
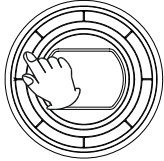

2. Press the PLAY MODE button (10) or (30) twice for tracks in current folder repeat.

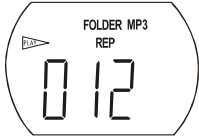
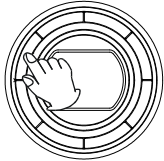

3. Press the PLAY MODE button (10) or (30) three times for tracks in all folder repeat.

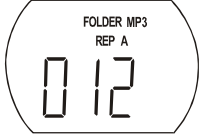
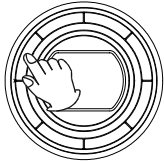

4. Press the PLAY MODE button (10) or (30) four times for tracks in random play mode. (in stop mode only)

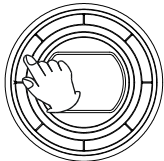

Note: Once your desired mode selected, press the PLAY/PAUSE button (13) or (35) to start playback from stop mode.

5. Press the PLAY MODE button (10) or (30) five times to cancel above modes.

PROGRAMMED PLAYBACK

This CD player enables you to program up to 20 tracks in the sequence of your choice. First select CD stop mode.

1. Press the PROGRAM Button (16) or (34) one time.

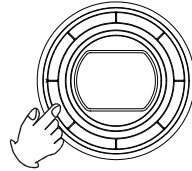

Program input mode

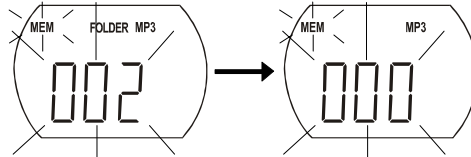

2. Press the FOLDER UP or FOLDER DOWN button (5)/(6) or (28)/(36) to select desired folder.

Choose folder 3

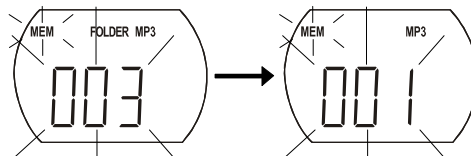

3. Press the CD SKIP ►► or ◀◀ button (15) or (33) to select the desired track to be programmed.

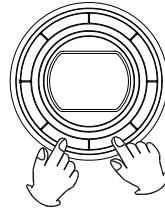

Choose track 4 in folder 3

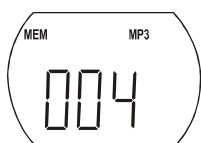

4. Press the PROGRAM button again, then track 4 of folder 3 is stored.

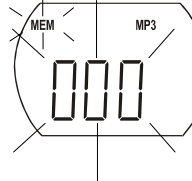
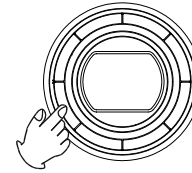

5. To continue to program, repeat steps 2 to 4 for each selection.

When Program is full

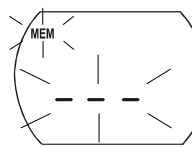

6. Press the PLAY/PAUSE button (13) or (35) to play the programmed tracks.

Playing track 4 of folder 3

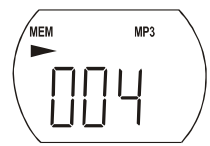

Note: Press the PROGRAM button (if programmed tracks still exist) then PLAY/PAUSE button, the program play will start again.

Clear the program

Press the PROGRAM button (16) or (34) to recall previously programmed track ("MEMORY" icon flashes), then press CD stop button to cancel the preset programs or change function mode or open the CD door.

Reviewing programs

Press the PROGRAM button (16) or (34) repeatedly. The track number programmed on each program number will be displayed.

CARE AND MAINTENANCE

COMPACT DISC CARE

- Treat the disc carefully. Handle the disc only by its edges. Never allow your fingers to come in contact with the shiny, unprinted side of the disc.
- Do not attach adhesive tape, stickers etc., to the disc label.
- Clean the disc periodically with soft, lint-free, dry cloth. Never use detergents or adhesive cleaners to clean the disc. If necessary, use a CD cleaning kit.
- If the disc skips or gets stuck on a section of the disc, it is probably dirty or damaged (scratched).
- When cleaning the disc, wipe in straight lines from the center of the disc to the edge of the disc. Never wipe in circular motions.
- To remove a disc from its storage case, press down on the center of the case and lift the disc out, holding it carefully by the edges.
- Fingerprints and dust should be carefully wiped off the disc's recorded surface with a soft cloth. Unlike conventional records, compact discs have no grooves to collect dust and microscopic debris so gently wiping with a soft cloth should remove most particles.

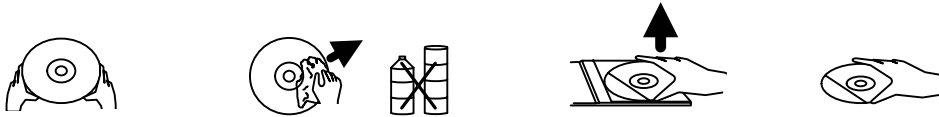

TROUBLESHOOTING GUIDE

Should this unit exhibit a problem, check the following before seeking service.

Symptom	Possible cause	Solution
Radio		
Noise or sound distorted on AM (MW) or FM broadcasts.	Station not tuned properly for AM (MW) or FM	Retune the AM (MW) or FM broadcast station.
	FM : Antenna is not extended.	Extend FM antenna.
	AM (MW) : Unit is not positioned correctly.	Rotate unit until best reception is obtained.
AM (MW) or FM, no sound.	FUNCTION Selector not set to RADIO position.	Set FUNCTION Selector to RADIO position.
	Volume at minimum	Increase Volume.
Compact Disc Player		
CD Player will not play.	FUNCTION selector not set to CD position.	Set FUNCTION selector to CD position.
	CD is not installed or installed incorrectly.	Insert CD with label side up.
CD skips while playing.	Disc is dirty or scratched.	Wipe disc with cloth or use another disc.
Disc is inserted but CD player skips over spot and will not play,	Disc inserted upside down.	Insert disc properly.
	Disc is dirty.	Clean disc.
	Disc is non-standard.	Use correct disc.

SPECIFICATIONS

Power Supply	AC 120Volts ~ 60Hz DC 3V (1.5V x 2 "AA" batteries for tuner memory)
Power Output	5 W/CH 10% THD
Dimension of Unit	200(W)x135(D)x262(H)mm
Radio Section	Tuning : PLL with 20 Presets (FM 10, AM 10) Freq. Range : AM 520 - 1710KHz, FM 87.5 - 108MHz
CD Section	Vertical Front Loading CD
Speaker System	Woofer: 4", 3.2 ohm Tweeter: 1 1/2"
Remote Control	12 Keys, Battery size "AA" x 2

Free Manuals Download Website

<http://myh66.com>

<http://usermanuals.us>

<http://www.somanuals.com>

<http://www.4manuals.cc>

<http://www.manual-lib.com>

<http://www.404manual.com>

<http://www.luxmanual.com>

<http://aubethermostatmanual.com>

Golf course search by state

<http://golfingnear.com>

Email search by domain

<http://emailbydomain.com>

Auto manuals search

<http://auto.somanuals.com>

TV manuals search

<http://tv.somanuals.com>