

# KAMBROOK

THE SMARTER CHOICE



**Carbon**  
**Tower Heater**  
KCF200

**Instruction Booklet**

# Important

Please retain your instruction book for future use.

In the event that you need some assistance with your Kambrook appliance, please contact our Customer Service Department on 1300 139 798 (Australia) or 09 271 3980 (New Zealand). Alternatively, visit us on our website at [www.kambrook.com.au](http://www.kambrook.com.au)

# Contents

Kambrook Recommends Safety First	p4
Your Carbon Tower Heater	p6
Quick Start Guide	p7
Using Your Carbon Tower Heater	p8
Care and Cleaning	p11
Warranty Details	p12

## Kambrook Recommends Safety First

# IMPORTANT: Please retain your instruction book for future use.

At Kambrook, we believe that safe performance is the first priority in any consumer product, so that you, our valued customer can confidently use and trust our products. We ask that any electrical appliance that you use be operated in a sensible fashion with due care and attention placed on the following important operating instructions.

## Important Safeguards For Your Kambrook Carbon Tower Heater

- Avoid touching heater body while it is on, some parts of the heater are hot. When moving the unit switch off and hold the heater by the handles where provided.
- Keep combustible materials such as drapes and other furnishings at least 1.7 metres from the front, sides and rear of the heater. Do not use heater to dry your laundry.



**WARNING:** In order to avoid overheating do not cover the heater.

- Extreme caution and supervision is necessary when this heater is used by or near children, invalids or animals.
- This appliance is not intended for use by persons (including children) with reduced physical, sensory or mental capabilities, or lack of experience and knowledge, unless they have been given supervision or instruction concerning use of the appliance by a person responsible for their safety.
- Children should be supervised to ensure that they do not play with the appliance.
- Important – this heater is intended for floor use only.
- Do not mount on ceiling or walls.
- Do not leave heater unattended. Always switch off the heater at the controls and at the power outlet then unplug heater from the power outlet when not in use.
- Do not operate heater whilst asleep.
- Do not operate any heater with a damaged cord or plug, or if heater has been dropped or damaged in any manner. Return heater to your nearest service centre for examination, electrical or mechanical adjustment or repair.
- Do not use outdoors. This heater is not intended for commercial use, such as construction sites.
- Do not locate the heater immediately below a socket outlet when in use.
- Do not use this heater with a programmer, timer or any other device that switches the heater on automatically. Since a fire risk may exist if the heater is covered or positioned incorrectly.
- This heater is not intended for use in wet or moist locations. Do not use this heater in the immediate surroundings of a bath, a shower or a swimming pool. Do not immerse or allow liquids to be spilled on heater.
- This heater has hot and arcing or sparking parts inside. Do not use in areas where petrol, paints, aerosols, or other inflammable substances are used or stored.
- Do not operate the heater with the power cord damaged, frayed or split, wound around any part of the heater, or in contact with heated surfaces of the heater.

- Do not allow materials that have been in contact with oil, petroleum based products or drying fluids to come in contact with the heater.
- Do not run the cord under carpeting or cover the cord with rugs, runners or the like. Arrange cord away from traffic areas and where it will not be tripped over.
- To disconnect heater turn the power to OFF; then turn the control switch to off. Turn off at the power outlet then remove the plug from its outlet.
- Do not insert or allow foreign objects to pass through the element guard, inlet or outlet openings. This may cause an electric shock, fire or damage the heater.
- To prevent a possible fire or heat damage, allow ample space around the heater (1.7m at front and 0.5m at the rear, top and sides) and do not totally or partially block the air inlet or outlets in any manner. Check the openings from time to time for accumulated dust. Ensure long shag carpet does not obstruct airflow under the unit.
- Do not touch hot metal surfaces.
- Switch off at the control switch and power outlet, then unplug and allow heater to cool down before cleaning or storing.
- The heater will not operate unless it is placed on a flat, level surface as it is fitted with a tilt switch.
- Always move the heater with the handle provided.
- Use this heater only as described in this instruction manual. Any other use not recommended by the manufacturer may cause fire electric shock or injury and voids all warranties.
- Regularly inspect the supply cord, plug, control settings, air inlets and outlets and main housing for any damage. If found damaged in any way, immediately cease use of the heater and return to Kambrook or an authorised service agent for inspection or repair.

**NOTE:** This Kambrook Carbon Tower Heater is electronically controlled and will not operate until the heater is plugged into a 230V or 240V power point and switched on.

## Important Safeguards For All Electrical Appliances

- Fully unwind the power cord before use.
- Do not let the power cord hang over the edge of a bench or table, touch hot surfaces or become knotted.
- The appliance is not intended for use by persons (including children) with reduced physical, sensory or mental capabilities, or lack of experience and knowledge, unless they have been given supervision or instruction concerning use of the appliance by a person responsible for their safety.
- Children should be supervised to ensure that they do not play with the appliance.
- It is recommended to regularly inspect the appliance. To avoid a hazard do not use the appliance if power cord, power plug or appliance becomes damaged in any way. Return the entire appliance to the nearest authorised Kambrook Service Centre for examination and/or repair, or contact Customer Service on 1300 139 798
- Any maintenance other than cleaning should be performed at an authorised Kambrook Service Centre.
- This appliance is for household use only. Do not use this appliance for anything other than its intended use. Do not use in moving vehicles or boats. Do not use outdoors. Misuse may cause injury.
- The installation of a residual current device (safety switch) is recommended to provide additional safety protection when using electrical appliances. It is advisable that a safety switch with a rated residual operating current not exceeding 30mA be installed in the electrical circuit supplying the appliance. See your electrician for professional advice.

# Your Kambrook Carbon Tower Heater

1. 1000 watt heating elements for efficient heating
2. ThermoGuard protection for peace of mind
3. Carbon heating elements for gentle heating and minimal moisture loss
4. Convenient carry handle
5. Safety tip-over cut-out switch



## Control Panel

6. Convenient 3hr auto-off timer
7. 2 heat setting modes
8. 60° degree oscillation for warmth throughout the room
9. Power-on indicator light

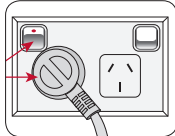
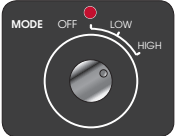

THERMO GUARD  
PROTECTED

## Quick Start Guide

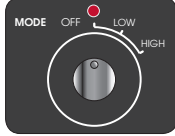
<p><b>Turning the heater on after assembly of heater</b></p>		<p><b>Setting the heating mode</b></p>	
			
<p>Set the MODE dial to the OFF position and TIMER dial to 0 MINS.</p>	<p>Plug the cord into a 230V or 240V power point and switch on.</p>	<p>Turn the MODE dial to the high or low setting.</p>	<p>Turn the TIMER dial to the ON position.</p>
<p><b>Setting the oscillation</b></p>	<p><b>Turning the heater off</b></p>		
			
<p>Press the SWING button to activate. Press again to stop the oscillation.</p>	<p>Turn the heater off by turning the MODE dial to the OFF position.</p>		

## Hints/Tips to Retain Heat in Your Home

- Don't overheat your home. The temperature of a heated room in winter should be 18-21°C
- Your heater will work more efficiently if you stick to Kambrook's recommended clearance spaces
- Choose the right size heater for the room type you want to heat
- Zone off unoccupied rooms by closing doors and only heat the main living areas
- Fit window coverings like curtains to limit winter heat loss
- Put draft stoppers, such as a rolled up towel, at the bottom of outside doorways to keep out cold air
- Keep the heat in and the cold out by installing wall and ceiling insulation.
- Avoid placing items too close to the heater (both at the front and back) for optimal air flow

## Using Your Carbon Tower Heater

Remove any promotional material or packaging from the heater.

Unwind the cord to its full length and place the heater on a firm, level surface in a stable upright position. Visually inspect the air inlet and outlets to ensure there are no blockages.

### Assembling Your Heater

Remove all items from the packaging - the carbon tower body, front and rear bases. Unscrew the two screws from the base of the tower body.

To join the front and rear bases together, initially feed the cord between the two parts of the base.

Position the front base over the corresponding posts of the rear base, and press down to fit the bases together. Ensure the cord remains within the channel formed when the two halves come together.

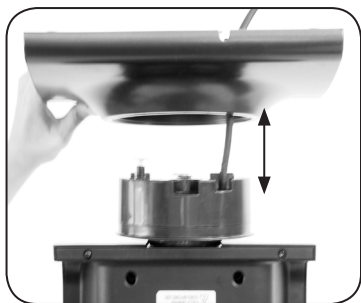

Turn the carbon tower body upside down. Align and position the base over the corresponding posts on the rear of the tower body. Push down the base onto the tower body until it is firmly held into position.

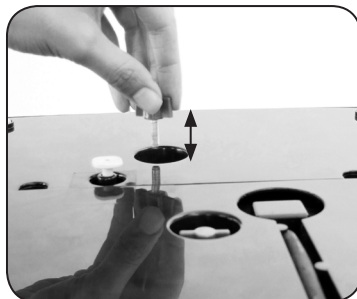

Use the screws provided to secure the tower body to the base.

Clip the cord into the straight slot, running from the centre to the edge of the base. Ensure the cord is tidily fitted into the channel, and flush with the base.

Turn the Carbon Tower Heater back to an upright position. It is now ready to use.

### Turning Your Heater On

Always place the heater on a firm, level surface in a stable upright position.

Ensure the MODE dial is turned to the OFF position, and the TIMER dial is turned to the 0 MINS position.

Plug the cord into a 230V or 240V power point and switch on.

**NOTE:** To avoid an electrical circuit overload, it is recommended that no other appliances are plugged into the same circuit as your heater, when it is in use.

The Power-On Indicator, on the front of the heater, will illuminate when the heater is turned on.



## Setting the Heating Mode



To control the heater, turn the MODE dial as follows.

The Heat Setting dial has 3 modes:

- OFF - Shuts off the heater
- 1 - Low heat setting (500W)
- 2 - High heat setting (1000W)

Once the heat setting has been selected, turn the TIMER dial to the ON position. This will activate the heater.

**NOTE:** The Carbon Tower Heater will not activate while the Timer dial is set at 0 MINS.

To switch the heater off, turn the MODE dial to the OFF position.

**NOTE:** This heater features a tip-over switch. If the heater tips over, it will automatically switch off. Once placed back into the upright position, the heater will activate again.

## Setting the Auto-Off Timer

The TIMER function works in all operating modes, and switches the unit off after a preset number of hours.

Turn the TIMER dial to activate the timer settings. The timer can be set for up to 3 hours.

For setting times less than 1 hour, turn the timer dial past the 2 hours mark, then turn back to the desired time.

The unit will then switch itself off after the selected time has passed.

By turning the TIMER dial to ON, this will ensure the heater runs continuously, and will not turn itself off.

## Setting the Oscillation

The oscillation function works in all operating modes.

Press the SWING button once to activate. The heater will begin to oscillate from side to side.

Press the SWING button again to stop the heater from oscillating.

## Using Your Carbon Tower Heater continued

### ThermoGuard Overheating Safety Device

THERMO  GUARD  
PROTECTED

Your heater is fitted with a safety device that switches off the heater in the event of overheating. Should this heater stop working, turn off the heater and inspect the air inlet and outlet for blockages. Wait at least five minutes for the protection system to reset before attempting to restart the heater.

If the heater fails to operate or the safety device switches off again, return the heater to your nearest Kambrook service centre for examination or repair.

## Care and Cleaning

Ensure that the heater is switched off and disconnected from the power point before cleaning.

Use a clean, dry cloth to clean the external surfaces of the heater. If the heater has collected dust or dirt inside the unit or around the elements, have the unit cleaned by a qualified service agent. Do not operate the heater in this condition.

Do not attempt to open the element guard or the case of the heater at any time as there are no customer serviceable parts inside.

When not in use, store the heater (preferably in its original box) in a cool, clean and dry location.

## Kambrook 12 Month Replacement Warranty

In Australia, this Kambrook Replacement Warranty does not affect the mandatory statutory rights implied under the Trade Practices Act 1974 and other similar State and Territory legislation relating to the appliance. It applies in addition to the conditions and warranties implied by that legislation.

In New Zealand, this Kambrook Replacement Warranty does not affect your mandatory statutory rights implied under the Consumer Guarantees Act 1993 in relation to the appliance. It applies in addition to the conditions and guarantees implied by that legislation.

This Kambrook Replacement Warranty is valid only in the country of purchase, but other statutory warranties may still apply.

This Warranty card and the purchase receipt for this product are to be retained as proof of purchase and must be presented if making a claim under the Kambrook Replacement Warranty. Please note that under any applicable statutory warranty you are not required to produce these documents, but may be required to provide a proof of purchase.

Kambrook warrants the purchaser against defects in workmanship and material for a period of 12 months domestic use from the date of purchase (or 3 months commercial use).

The Kambrook Replacement Warranty does not apply to any defect, deterioration, loss, injury or damage occasioned by, or as a result of, misuse or abuse, negligent handling or if the product has been used other than in accordance with the instructions. The Kambrook Replacement Warranty excludes breakables such as glass and ceramic items, consumable items and normal wear and tear.

This Kambrook Replacement Warranty is void if there is evidence of the product being tampered with by unauthorised persons.

If the product includes one or a number of accessories only the defective accessory or product will be replaced. Subject to your statutory rights, in the event of Kambrook choosing to replace the appliance, the Kambrook Replacement Warranty will expire at the original date, i.e. 12 months from the original date of purchase.

In the event that you need some assistance with your Kambrook appliance, please contact our Customer Service Department on 1300 139 798 (Australia) or 09 271 3980 (New Zealand). Alternatively, visit us on the website at [www.kambrook.com.au](http://www.kambrook.com.au)

### Kambrook 12 Month Replacement Warranty

Your Purchase Record (Please Complete)

Attach a copy of the purchase receipt here.

Date Of Purchase \_\_\_\_\_

Model Number \_\_\_\_\_

Serial Number \_\_\_\_\_

Purchased From \_\_\_\_\_

(Please don't return purchase record until you are making a claim)

Register your warranty at [www.kambrook.com.au/service.asp](http://www.kambrook.com.au/service.asp)

Kambrook - Australia  
Building 2, Port Air Industrial Estate  
1A Hale Street  
Botany NSW 2019  
Australia  
Customer Service Line 1300 139 798  
Customer Service Fax 1800 621 337

Kambrook - New Zealand  
Private Bag 94411  
Botany, Manukau  
Auckland 2141  
New Zealand  
Customer Service Line/Spare Parts  
0800 273 845 or 09 271 3980  
Customer Service Fax 0800 288 513

**KAMBROOK**  
THE SMARTER CHOICE

Due to continual improvement in design or otherwise, the product you purchase may differ slightly from the illustration in this book. Issue 1/10

## Free Manuals Download Website

<http://myh66.com>

<http://usermanuals.us>

<http://www.somanuals.com>

<http://www.4manuals.cc>

<http://www.manual-lib.com>

<http://www.404manual.com>

<http://www.luxmanual.com>

<http://aubethermostatmanual.com>

Golf course search by state

<http://golfingnear.com>

Email search by domain

<http://emailbydomain.com>

Auto manuals search

<http://auto.somanuals.com>

TV manuals search

<http://tv.somanuals.com>