

## KM 85/50 W B

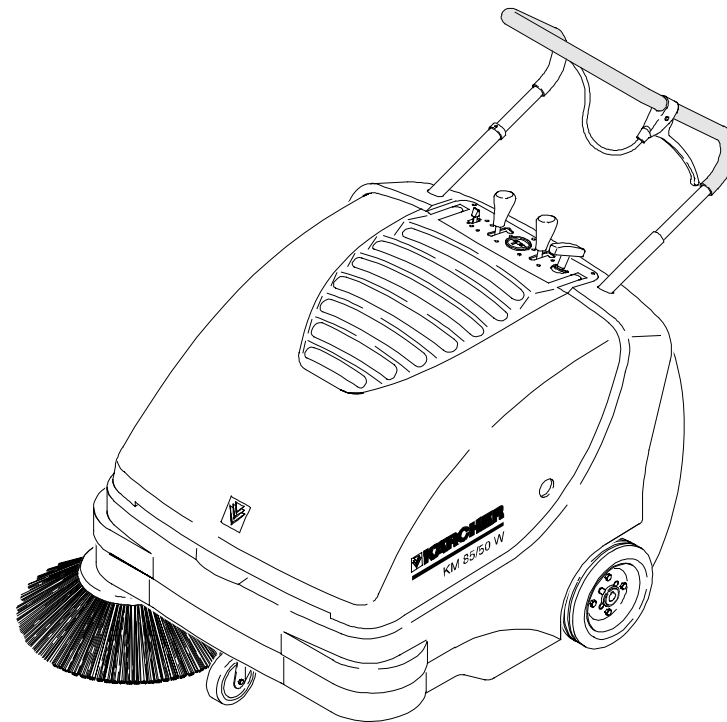

1.351-105.0

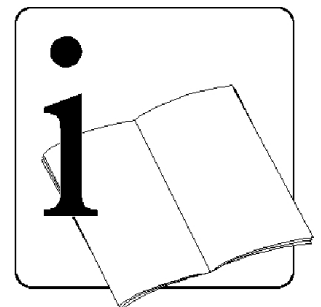

**Contents**

<b>For your own safety!</b>	<b>20</b>	<b>Usage instructions</b>	<b>24</b>	<b>Maintenance tasks</b>	<b>27</b>	<b>Accessories</b>	<b>32</b>
General notes	20	Safety instructions when sweeping	24	Preparations	27	<b>Fault instructions</b>	<b>32</b>
Risk of overturning on too high gradients!	21	Sweeping dry ground	25	Checking the safety switch	27	<b>Technical data</b>	<b>32</b>
<b>For our environment</b>	<b>21</b>	Sweeping damp or wet ground	25	Safety notes	27	Unit data	32
Caution, danger to the environment from engine or hydraulic oil!	21	Driving over obstacles	25	Check the engine oil level	27	Engine	32
<b>Intended use</b>	<b>21</b>	<b>Stop machine</b>	<b>25</b>	Top up engine oil	28	Filter and suction system	32
<b>Function description - sweeping machine</b>	<b>21</b>	Clean filter	25	Change the engine oil	28	Unit vibrations (ISO 5349)	33
<b>Machine components</b>	<b>21</b>	Empty the swept material container	25	Check the air cleaner	28	Ambient conditions	33
<b>Before first operating</b>	<b>21</b>	<b>Cleaning and maintenance</b>	<b>26</b>	Clean and change spark plug	28	<b>EC conformity declaration</b>	<b>33</b>
Unloading instructions	21	Internal cleaning	26	Empty fuel tank	28		
Tests	21	External cleaning	26	Check the sweep roller	29		
Installation	21	<b>Decommissioning</b>	<b>26</b>	Replace the sweep roller	29		
Push handle with bowden cable and cover support assembly	22	<b>Transport</b>	<b>26</b>	Checking and adjusting sweeping area of the sweeping roller	30		
Bowden cable assembly	23	Transport instructions	26	Replacing the side broom	30		
Side broom installation	23	<b>Maintenance intervals</b>	<b>26</b>	Adjusting lowering of side brush	30		
<b>Before every operation</b>	<b>23</b>	Elapsed-time meter	26	Adjusting raising of coarse- dirt flap	30		
General notes	23	Maintenance by the customer	26	Adjusting and replacing sealing strips	31		
Testing and maintenance work	23	Maintenance by the customer service department	27	Replace the dust filter	31		
<b>Commissioning</b>	<b>23</b>						
Start machine	23						
Sweeping operation	24						
Run machine	24						

**For your own safety!****General notes**

**It is mandatory to read and observe this prior to using the appliance!**

- Notify your sales outlet if during unpacking you detect damage that has occurred in transit.
- Read the operating instructions of your appliance prior to putting it into operation, especially the safety information.
- The danger and caution signs attached to the appliance give important tips on its safe operation.
- In addition to the instructions in the operating instructions, general safety- and accident prevention-regulations from lawgivers must be followed.
- To increase your safety during work on downward slopes with a gradient greater than 2% we recommend installation of the additional brake 2.640-301.0 accessory kit (ABS).

**Use**

- Prior to utilization the appliance and its working facilities must be checked regarding their proper condition and that they operate safely. It must not be used if its condition is not faultless.
- No modifications permitted on the machine.

- Never absorb explosive liquids, inflammable gases or undiluted acids and solvents! This includes petrol, paint thinner or fuel oil, which can form explosive fumes due to the swirling suction air, in addition acetone, undiluted acids and solvents, since they corrode the materials used for the appliance.
- Do not sweep up/absorb burning or smouldering objects.

**Only if expressly marked is this appliance suitable for sucking up health-hazardous dusts.**

Comply with notices concerning safety regulations given in the operating instructions.

- Suitable only for the surfaces listed in the operating instructions.
- The appliance may be used on only the areas cleared for its use by the factory owner or a person authorized by him.
- Keep clear of the danger area. Its operation in explosion hazardous locations is prohibited.
- The following applies generally: Keep highly inflammable materials away from the machine (explosion/fire hazard).

**Operation**

- The rules, regulations and stipulations applying to motor vehicles must always be observed.
- The operator must use the unit in accordance with its intended purpose. She must adapt her mode of operation to the local conditions and when working with the appliance keep a look out for third parties, especially children.
- The unit can reverse and drive forwards at the same speed. Therefore, take care when pulling back push handle for reversing.
- The appliance may only be used by persons instructed in its handling or who have proved their capability of operating it and who are expressly authorized to use it.
- The unit must not be operated by children and youths.
- The appliance must never be left unattended as long as the motor is running. The operator may not leave the unit unless the engine is shut down, the unit is secured against inadvertent motions and, if necessary, the parking brake is applied.
- On slopes the angle of inclination to the side and in the direction of motion must not exceed the value given in the operating instructions.

**Transport**

- The motor must be turned off when the appliance is transported.
- To lock the parking brake.
- Secure the machine with guy belts, ropes or chains.
- Immobilise the machine at the wheels with chocks.

**Maintenance**

- Repairs may only be carried out by approved customer service centres or by technical personnel trained in this field which are familiar with all relevant safety regulations.
- Industrially used appliances in changing locations are subject to the safety inspection according to VDE 0701.
- The unit must be switched off prior to cleaning the unit and performing maintenance work on it, or setting it to another operation.
- Unless expressly permitted, the unit may not be cleaned with hose or high-pressure water jets (danger of short-circuits or other impairments).

**Accessories and spare parts**

- Only accessories and spare parts cleared by the manufacturer may be used. Genuine accessories and spare parts guarantee that the unit can be operated safely and trouble-free.

**Combustion engine**

- The exhaust opening must not be sealed.
  - Do not bend over or touch the exhaust opening (danger of burns).
  - Do not touch or grasp the drive motor (danger of burns).
  - Adequate ventilation and extraction of exhaust must be provided when operating the unit indoors. (Danger of poisoning)
  - Exhaust gases are toxic and damaging to health; do not inhale them.
  - The engine takes approx. 3..4 s to run down after being shut off. It is imperative to keep away from the area of the drive unit during this period!
- Observe the following when refuelling:
- Only the fuel specified in the operating instructions may be used. An explosion hazard exists with unsuitable fuels.
  - The engine must be switched off.
  - Do not fill-in fuel in closed rooms.
  - Make sure that no fuel comes into contact with hot surfaces.
  - Do not use any burning or smouldering objects during filling up or carry them with you or bring them in the vicinity of the appliance (explosion hazard).
  - Fill the tank at the most 1 cm below the lower edge of the filler neck, since the fuel expands in heat.
  - Wipe off spilled over fuel and close tank cap tightly.

**Risk of overturning on too high gradients!**



*The machine could topple over when driving and turning on slopes.*

- In direction of travel only negotiate gradients up to 18 %
- At right angles to direction of travel only negotiate gradients up to 18 %.

**For our environment**

**Caution, danger to the environment from engine or hydraulic oil!**



- Take spent oil after an oil change to an oil collecting point or a waste disposal company.

**Intended use**

- This sweeper is predominantly intended for sweeping outside surfaces.
- It complies with the "L" application category for non-health hazardous dusts.
- It is not intended for use on public traffic routes

**Suitable surfacings:**

- Asphalt
- Paving stones
- Screed
- Concrete

**Function description - sweeping machine**

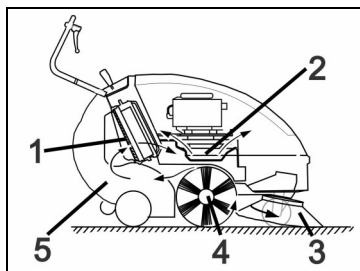

The KM 85/50 W B works according to the throw-over principle.

- The side brush (3) cleans corners and edges of the sweeping surface and transports the dirt in the path of the main brush.
- The rotating main brush (4) transports the dirt directly into the debris container (5).
- The dust swirled up in the container is separated by way of the dust filter (1) and the filtered, clean air removed by the suction turbine (2).

**Machine components**

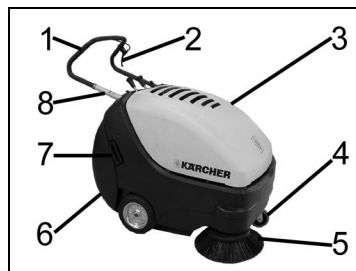

1. Push handle
2. Lever for coarse-dirt flap
3. Unit cover
4. Swivel caster with parking brake
5. Side brush
6. Debris container with transport rollers
7. Filter shaker for the dust filter
8. Push handle lock



1. Starter rope
2. Raise / lower main brush
3. Elapsed-time meter
4. Lifting/lowering side brush
5. Multifunctional lever

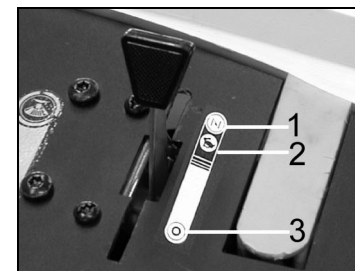

- Multifunctional lever
1. Setting "CHOKE" starting aid
  2. "HARE" setting – operating speed
  3. "0" setting – engine OFF

**Before first operating**

**Unloading instructions**

- The machine was secured on a pallet with stretch belts or ropes for safe transport. Proceed as follows when unloading:
- Cut the plastic packing tape and remove the film
- Knock aside the wheel securing blocks and lift the machine off the pallet by hand



**Warning!** Do not use a fork lifter for unloading; the machine can be damaged by it.

**Tests**

- Check the engine oil level  
See maintenance tasks chapter for description
- Check that the spark plug connector is tightend securely  
See maintenance tasks chapter for description

**Installation**

- Install push handle with bowden cable and cover support  
See below for description
- Mount the side broom  
See below for description

**Push handle with bowden cable and cover support assembly**



- Lock swivel caster with parking brake

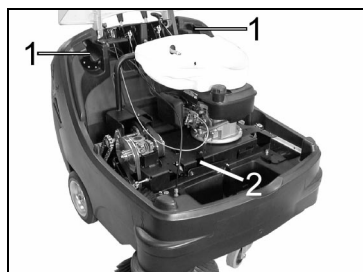

1. Opening for push handle
2. Fastening for bowden cable

**Push handle components**

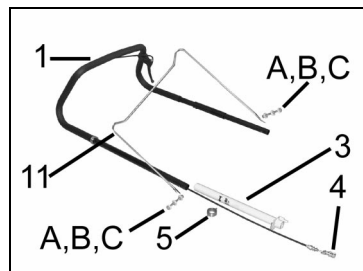

1. Push handle
- A, B, C hexagon head screw (2x) with lock nut (2x) and washers (6x)
3. Push handle lock
4. Bowden cable
5. Lock ring for push handle lock
11. Cover support

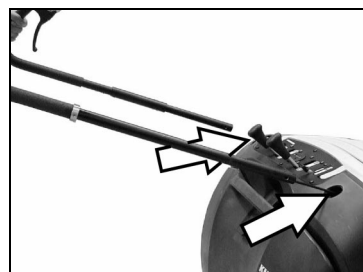

- Feed push handle through the left and right openings into interior



- Raise unit cover and have it held up by a helper

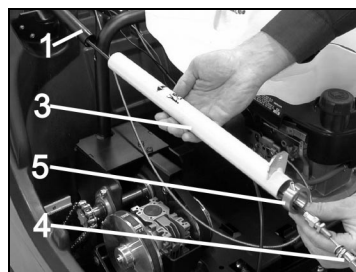

- Observe sequence!
- Slip push handle lock (3) over the bowden cable (4)
  - Then slide lock ring of push handle lock (5) over bowden cable (4)
  - Slip push handle lock (3) and lock ring for push handle lock (5) over push handle (1)

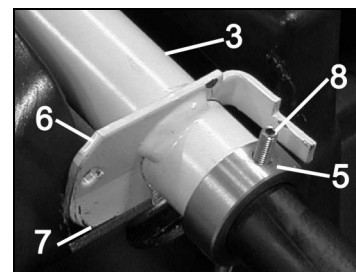
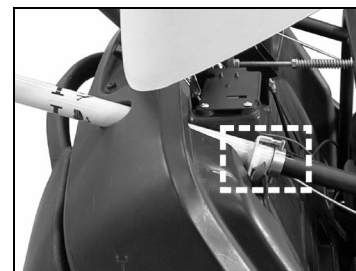

- Slide push handle lock (3) up to stop at the push handle, outside the container
  - Position stop plate (6) behind the bulge (7)
  - Position and centre screw (8) of lock ring (5)
- Screw (8) serves as a stop
- Tighten screw (8)

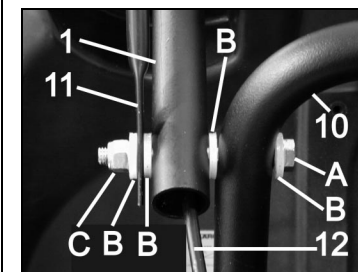
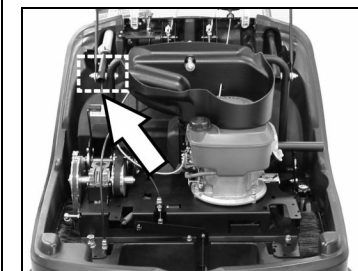

**Sequence from the inside to the outside**

- Insert hexagon head screw (A) with washer (B) from the inside through bottom part of push handle (10)
- Slip washer (B) onto hexagon head screw
- Position push handle (1) outside bottom part of push handle (10) and insert screw (A)
- Slip washer (B) onto hexagon head screw



**Warning!**

- The inner bowden cable (12) must be laid below screw (A).

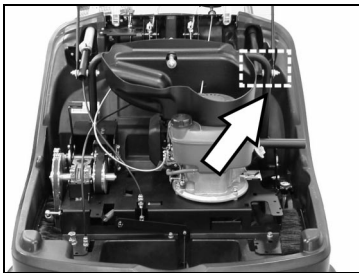

**Bowden cable assembly**



Laying the bowden pull cable

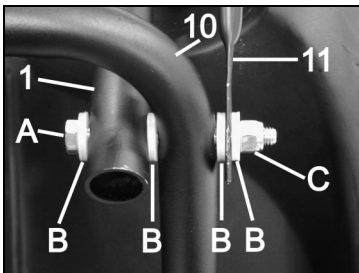

**Sequence from the inside to the outside**

- Insert hexagon head screw (A) with washer (B) from the inside through push handle (1)
- Slip washer (B) onto hexagon head screw
- Push hexagon head screw (A) through bottom part of push handle (10)
- Slip washer (B) onto hexagon head screw
- Push both sides of cover support (11) onto hexagon head screws
- Slip one washer (B) on each of the two hexagon head screws
- Screw one nut (C) on each of the two hexagon head screws and tighten nuts so that the joint is still flexible

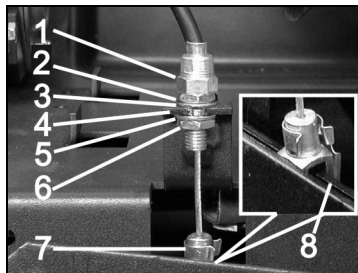

- Hinge adjusting nut (1) in retaining plate (4)
- Tighten locking nut (6), flat washers (3 and 5), onto locking nut (2)
- Take out pin from fork head (7)
- Position fork head (7) to lever (8)
- Push pin through fork head (7) and lever (8) and secure it

**Side broom installation**



**Warning!**  
Close fuel shut-off valve prior to starting assembly work.

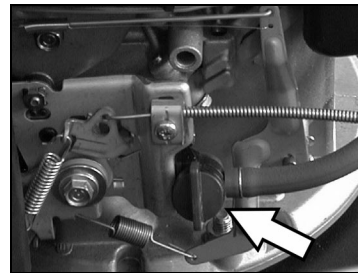

- Close the fuel feed line  
— Rotary knob is transverse to fuel hose
- Unlock push handle lock by turning it anticlockwise



**Danger!**  
— The permissible maximum tank filling when the sweeper is tilted back onto the push handle is half!

- Remove the debris container prior to tilting the sweeper (see section on "Emptying debris container") and unlock the push handle lock!

- Tilt the machine back

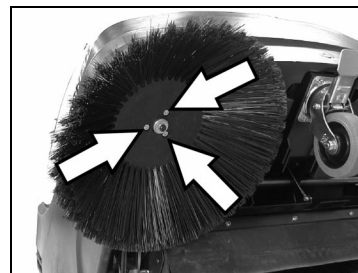

- Push side brush onto shaft
- Fasten with screws (3 pieces)
- Tilt the machine back upright

**Before every operation**

**General notes**

- Stand sweeper on a flat surface
- Shut-off the engine
- Set parking brakes on the front of the swivel caster
- Turn push handle lock clockwise  
— The lock is interlocked

**Testing and maintenance work**

- Check the engine oil level. \*
- Check fuel level in tank.
- Check the side brush.
- Check the sweep roller. \*
- Clean filter. \*\*
- Empty the swept material container. \*\*

\* See chapter on maintenance work  
\*\* See chapter on shutting off the machine

**Commissioning**

**Note:**

- Initial operation permissible only if the unit's cover is closed!
- For the protection of the operator, the unit is provided with a safety switch. The engine only runs when the unit cover is closed.

**Start machine**



- Open unit cover

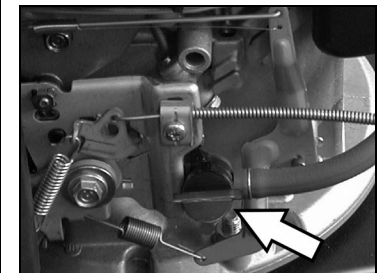

- Open fuel supply  
— Rotary knob is horizontal to fuel hose
- Close unit cover



- Release parking brake



**To lock push handle (idling)**

- Turn push handle lock clockwise; lock is interlocked
- The unit can be moved manually

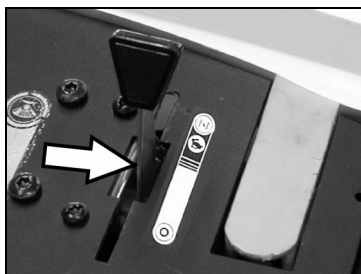

- Push the multi-functional lever into the "Operating speed" position

**Note:**

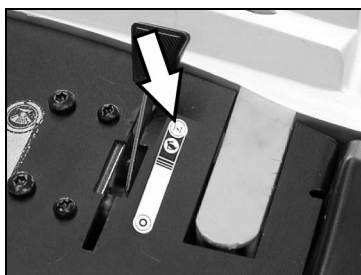

Set it to "CHOKE" in cold or wet weather

**Note:**

Only when set to "Operating speed" does the sweeper operate at its best



- Pull the starter rope slowly until resistance is felt
- Pull the starter rope strongly

**Note:**

- The sweep roller and side broom rotate
- Once the motor is running, move the multi-function control stalk from "CHOKE" to "Operating speed"

**Sweeping operation**

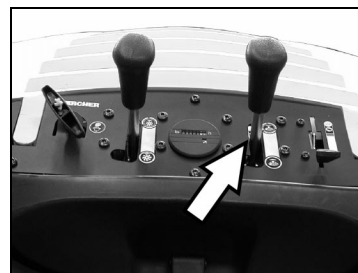

**Lower side brush**

- Release lever lock

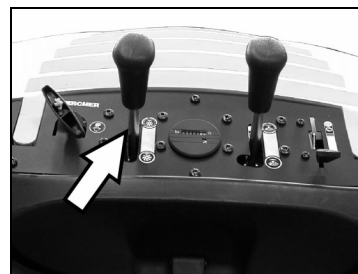

**Lower main brush**

- Release lever lock

**Run machine**



**Danger!**

The unit can reverse and drive forwards at the same speed. Therefore, take care when pulling back push handle for reversing.



- Turn push handle lock anticlockwise; the lock is released
- Press push handle forward; drive forward
- Pull push handle back; reverse.

**Usage instructions**

**Safety instructions when sweeping**



**Warning!**

Never sweep up packing straps, wires or the like as this could damage the sweeping mechanism.



**Danger!**

When the coarse-dirt flap is open, the main brush can hurl stones or stone chips forwards. Make sure that nobody, no animals or objects are endangered.

**Note:**

The coarse-dirt flap must be briefly raised for sweeping up largish objects up to a height of 50 mm, for example, drinks cans.



- Raise coarse-dirt flap

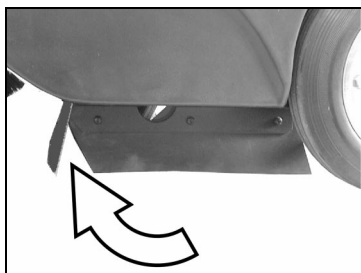

Lifted coarse-dirt flap



➤ Let down the coarse-dirt flap

**Note:**

An optimal cleaning effect can be achieved only when the coarse-dirt flap is completely lowered

**Sweeping dry ground**

- For optimum cleaning effect, match the driving speed to suit the actual conditions.
- Regularly clean-down the filter and empty the swept material container during operation.

**Sweeping damp or wet ground**



- Open latch of debris container, leave latch engaged
- Debris container opens approx. 8 cm.

**Note:**

The dust filter is protected from moisture.

**Driving over obstacles**

**Fixed obstacles of up to 30 mm in height**

- Slowly and carefully drive over them in the forward direction

**Fixed obstacles over 30 mm in height**

- Drive the unit over a ramp.

**Stop machine**

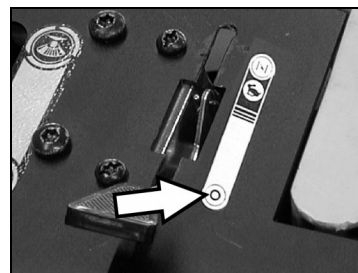

**Switch-off engine**

- Push the multi-functional lever into the "0" position

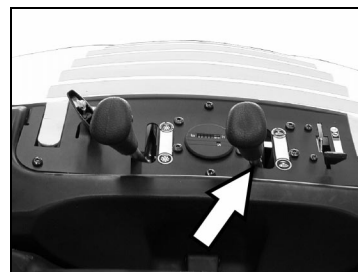

➤ Raise the side broom

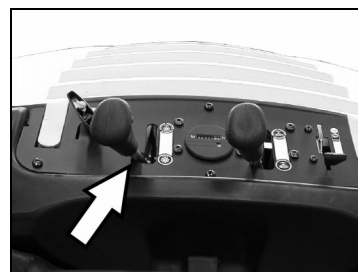

➤ Raise the sweep roller



**Warning!**

For shut off the side brushes and the main brush must always be raised (deformation hazard of main brush or side brushes).



➤ Lock the hand brake

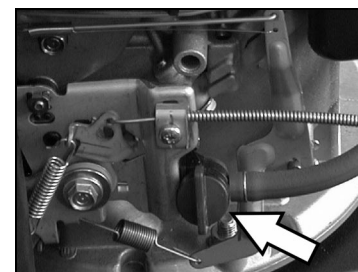

- Close the fuel feed line
- Rotary knob is transverse to fuel hose

**Clean filter**

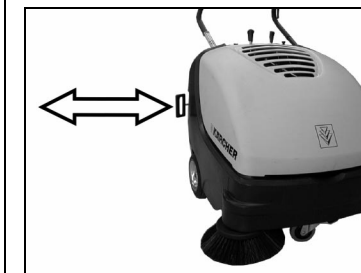

- Move the handle of the filter clean-down device to and fro several times

**Empty the swept material container**

- De-dust the filter first before opening emptying the debris container.
- (See chapter on de-dusting filter)

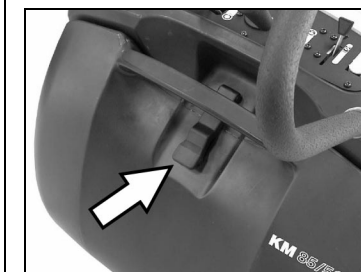

➤ Release latch



### Cleaning and maintenance

- Stand sweeper on a flat surface
- Lock the hand brake



- Unhinge latch



- Pull out debris container.
- Empty the swept material container.
- Push-in the swept material container.
- Engage latch at debris container
- Close latch

**Note:**

The debris container is provided with transport rollers

### Internal cleaning



**Danger!**

*Wear dust mask!*

*Wear safety goggles!*

- Blow-out with compressed air
- Clean with a rag

### External cleaning

Clean with a moist rag.

**Note:**

*Do not use aggressive cleaning agents!*

### Decommissioning

Please observe the following points when the machine will not be used for a lengthy period:

1.
  - Turn off the machine on a protected and dry place
  - Stand sweeper on a flat surface
  - Lock the hand brake
  - Safeguard the sweeping machine from rolling away
  - Lock push handle
2.
  - Raise the sweep roller
  - Raise the side broom
3.
  - Clean inside and outside of sweeper
  - Empty fuel tank
4.
  - Pull the spark plug connector off and screw the spark plug out
  - Pour approx. 3 cm<sup>3</sup> engine oil in the spark-plug hole and crank engine several times without spark-plug
  - Screw in the spark plug

### Transport

#### Transport instructions



**Warning!**

When it is transported the machine must be secured against dislocation

- Lock the hand brake
- Empty fuel tank
- Secure the machine with stretch belts or ropes
- Secure the machine with wedges on the wheels
- Lock push handle



Fastening areas

1. over the push handle
2. beneath the unit's cover

**Note:**

Observe markings for fastening areas on base frame! (chain symbols)

### Maintenance intervals

#### Elapsed-time meter

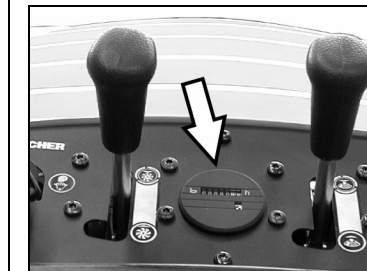

Elapsed-time meter indicates maintenance interval times.

#### Maintenance by the customer



**Warning!**

*For a new engine, an oil change is necessary after the first month or after the first 5 operating hours!*

#### Daily maintenance

- Check the engine-oil level, top up as required
- Check air filter
- Check roller and side brush for wear and trapped straps
- Check the function of all operating controls

#### Maintenance every 25 hours

- Clean air filter

**Maintenance every 50 operating hours**

- For oil change, filling quantity, and type see Technical Data
- Check the air cleaner, replace if greatly fouled
- Check the spark plug, clean it if required
- Check operation of safety switch
- Check tension, wear and operation of traction belts and drive chain
- Check freedom of movement of Bowden cables and moving parts
- Check sealing strips at dust filter and operation of filter shaker
- Check setting and wear of sealing strips in sweeping area
- Check sweeping pattern and operation of main brush and side brush
- Clean and check dust filter, replace, if necessary
- Check roller and side brush for wear and trapped straps
- Check operation of all operating devices and indicator lights

**Note:**

Where maintenance is undertaken by the customer, all service and maintenance work must be carried out by a qualified employee. A Kärcher specialist dealer can be consulted whenever support is necessary.

**Maintenance by the customer service department**

(Comply with service manual)

**Maintenance after the first month or 5 operating hours**

First inspection

**Maintenance every 50 operating hours**

**Maintenance every 100 operating hours or half-yearly**

**Maintenance every 500 hours or yearly**

**Note:**

To safeguard warranty rights, during the warranty period all service and maintenance work must be performed by an authorised Kärcher after sales service.

**Maintenance tasks**

**Preparations**

- Stand sweeper on a flat surface
- Lock the hand brake
- Lock push handle

**Checking the safety switch**



**Warning!**

- The engine must cut out if the unit cover is opened while the engine is running.
- The safety switch is defective if the engine does not cut out.
- Inform After-Sales Service.



- Open unit cover

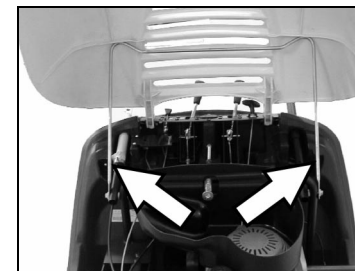

- Safeguard the unit cover from shutting with the cover support during work on the unit

**Safety notes**



**Danger!**

The engine takes approx. 3...4 s to run down after being shut off. It is imperative to keep away from the area of the drive unit during this period!



**Danger!**

**Danger of burns!**

- Allow the machine to adequately cool down prior to all maintenance and repair work
- Do not touch hot parts such as drive motor and waste gas system.



**Caution, environment is endangered by engine oil!**

- Take spent oil after an oil change to an oil collecting point or a waste disposal company.



**Danger!**

- The permissible maximum tank filling when the sweeper is tilted back onto the push handle is half!
- Close the fuel feed line
- Remove the debris container prior to tilting the sweeper (see section on "Emptying debris container") and unlock the push handle lock!

**Check the engine oil level**

**Note:**

Allow at least 5 minutes to elapse after engine standstill before checking it

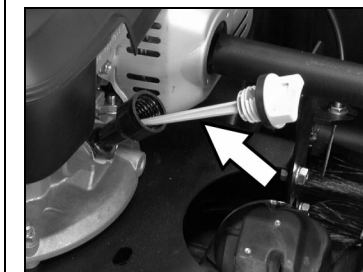

- Turn out oil dip stock

**Top up engine oil**

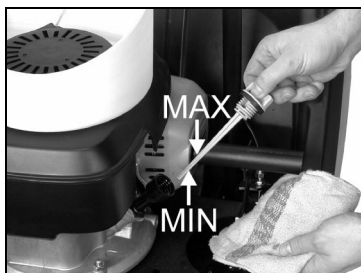

- Wipe oil dip stick and screw it in
- Screw oil dip stick out again
- The oil level must be between the "Min" and the "Max" marks
- Top up the engine oil if the oil level is below the "Min" mark
- Screw in oil dip stick and pull it tight

**Note:**  
Do not fill up beyond "Max"

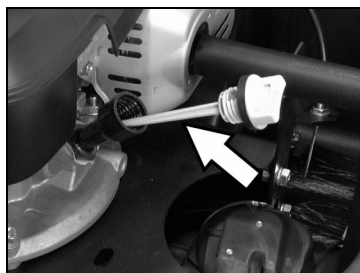

- Turn out oil dip stock

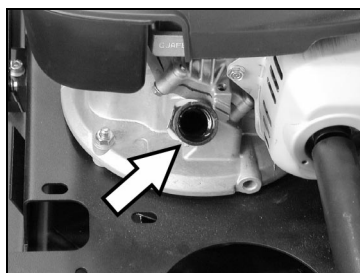

- Fill-in engine oil  
Oil types: See technical data
- Screw in oil dip stick and pull it tight
- Wait for at least 5 min.
- Recheck the engine-oil level

**Change the engine oil**

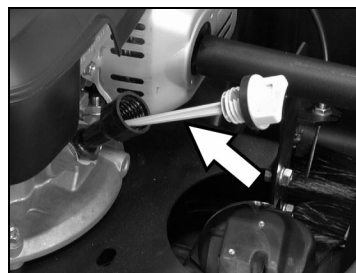

- Turn out oil dip stock



- Suck out engine oil with oil-change pump 6.491-538.0 through the oil filler

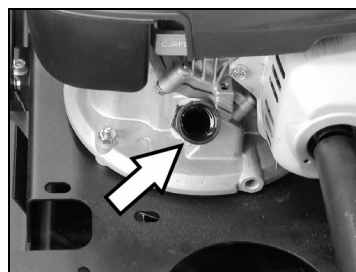

- Fill-in engine oil.  
— Oil grades and oil quantity: See technical data
- Check the engine oil level
- Screw in oil dip stick and pull it tight

**Check the air cleaner**

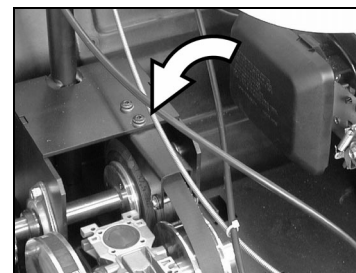

- Remove the cover

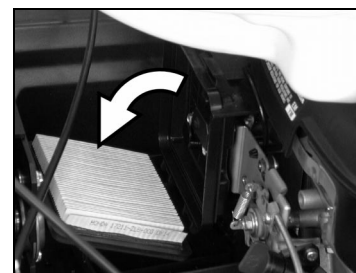

- Take out filter cartridge.

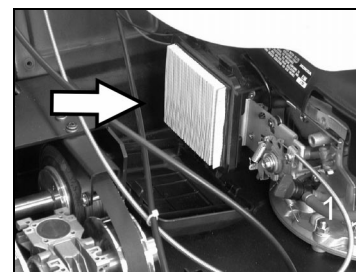

- Use a new filter cartridge.  
— Filter fins point to cover
- Put on cover

**Clean and change spark plug**



- Remove the spark plug connector
- Screw the spark plug out and clean it
- Screw in cleaned or new spark plug and tighten it
- Plug in the spark plug connector.

**Empty fuel tank**

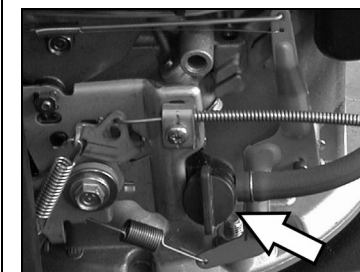

- Close the fuel feed line  
— Rotary knob is transverse to fuel hose

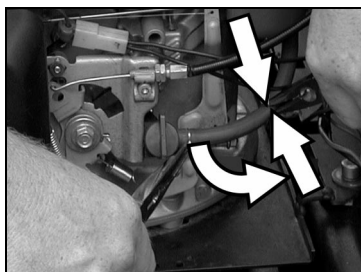

- Compress the fuel hose from the tank to the fuel shut-off valve
- Disengage the clamp at the fuel shut-off valve.
- Remove the fuel hose.

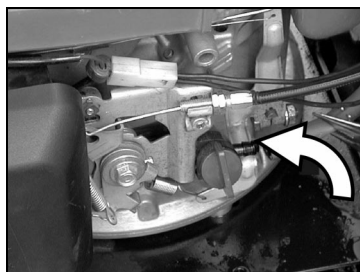

- Replace the fuel hose onto the neck of the fuel shut-off valve and replace the hose clamp when the tank is empty!

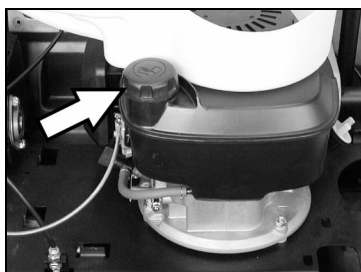

- Open tank cap



- Hold the fuel hose over a suitable collecting basin and allow the fuel to drain



- Remove tapes and string from the sweep roller
- Insert the swept material container

### Replace the sweep roller

Replacement is necessary when the main brush cannot be readjusted any more and sweeping efficiency obviously deteriorates due to worn bristles.



**Warning!**  
Close fuel shut-off valve prior to starting.

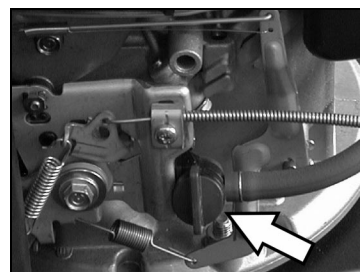

- Close the fuel feed line  
— Rotary knob is transverse to fuel hose
- Unlock push handle lock by turning it anticlockwise



**Danger!**  
— The permissible maximum tank filling when the sweeper is tilted back onto the push handle is half!

- Remove the debris container prior to tilting the sweeper (see section on "Emptying debris container") and unlock the push handle lock!

- Tilt the machine back

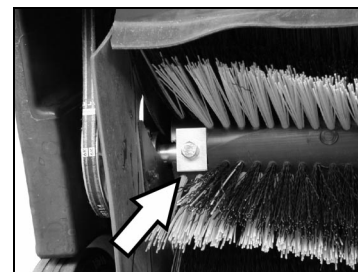

- Unscrew the left and right fastening screws

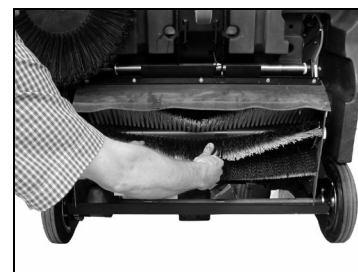

- Remove main brush downwards

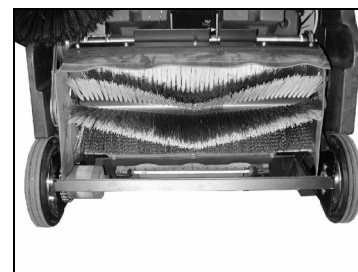

- Pay attention to the position of the bristle set when installing the new main brush!

### Note:

The bristle pile is structured to an arrow which must point towards the rear wheels.



- Insert new main brush and fasten

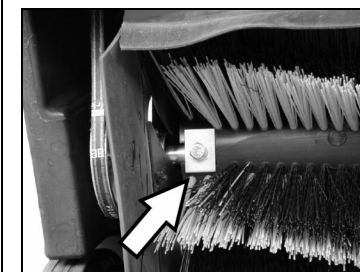

- Make sure that the position of the rectangular clamping plate is proper!
- It must overlap the main brush at the top and bottom
- Insert the swept material container

### Checking and adjusting sweeping area of the sweeping roller

- Cover a level surface evenly with dust
- Raise the sweeping machine on the front and put it on the prepared surface
- Lock the hand brake
- Run the main brush for approx. 15-30 s
- Raise the sweeping machine on the front and move it to the side

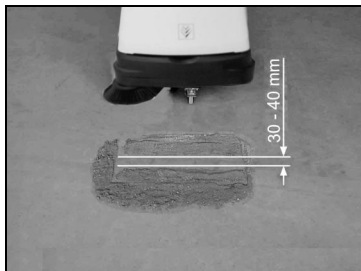

The shape of the sweeping area forms a symmetrical rectangle which is between 30 - 40 mm wide.

#### Note:

If the sweeping pattern is uneven it can be corrected by readjusting the sweeping pattern width! The bowden cable must be readjusted if the sweeping pattern is insufficient and the bowden cable is tight when the main brush is in its lowered position.



#### **Danger!**

For all work in this area care must be taken to ensure that the exhaust pipe has cooled down. Burns can be caused by touching it.

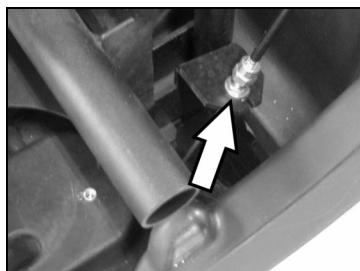
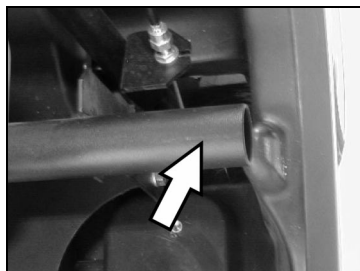

#### **Adjusting the width of the sweep mirror**

- Set sweeping pattern at the bowden cable
- Check the sweep mirror again

### Replacing the side broom

Replacing it is necessary when the sweeping effect visibly deteriorates due to wear of the bristles.



#### **Warning!**

Close fuel shut-off valve prior to starting assembly work.

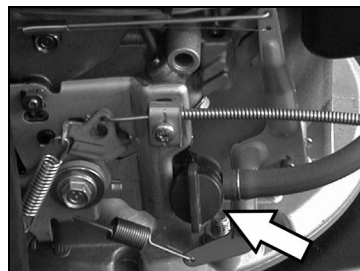

- Close the fuel feed line — Rotary knob is transverse to fuel hose
- Unlock push handle lock by turning it anticlockwise



#### **Danger!**

- The permissible maximum tank filling when the sweeper is tilted back onto the push handle is half!
- Remove the debris container prior to tilting the sweeper (see section on "Emptying debris container") and unlock the push handle lock!

- Tilt the machine back

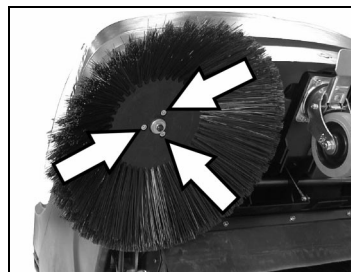

- Undo screws (3 pieces) at underside of the side brush
- Take-off the side broom
- Slide new side brush onto shaft
- Fasten with screws (3 pieces)
- Tilt the machine back upright

### Adjusting lowering of side brush

Readjustment is necessary when the sweeping efficiency of the side brush deteriorates due to worn bristles.



- Unscrew locking nut
- Readjust the setscrew
- Tighten the locking nut

### Adjusting raising of coarse-dirt flap

Readjustment is necessary when it is not possible to sufficiently raise or lower the coarse-dirt flap.

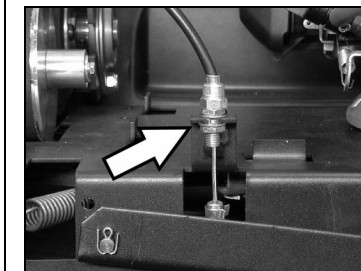

- Unscrew the locking nut
- Readjust the setscrew
- Tighten the locking nut

### Adjusting and replacing sealing strips

When the sweeping effect diminishes due to wear of the sealing strips they must be readjusted or replaced



**Warning!**

Close fuel shut-off valve prior to starting assembly work.

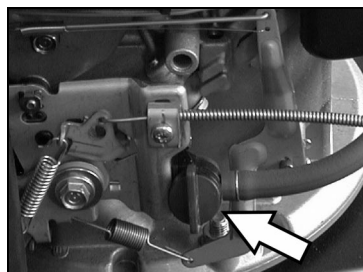

- Close the fuel feed line
- Rotary knob is transverse to fuel hose
- Unlock push handle lock by turning it anticlockwise



**Danger!**

— The permissible maximum tank filling when the sweeper is tilted back onto the push handle is half!

- Remove the debris container prior to tilting the sweeper (see section on "Emptying debris container") and unlock the push handle lock!

- Tilt the machine back



#### Front sealing strip

- Loosen the fastening screws of the sealing strip

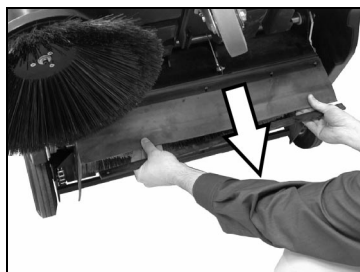

- Readjust the sealing strip downwards by relocating it in the elongated hole
- Tighten the fastening screws of the sealing strip
- Set the vacuum sweeper upright and push it slightly forwards

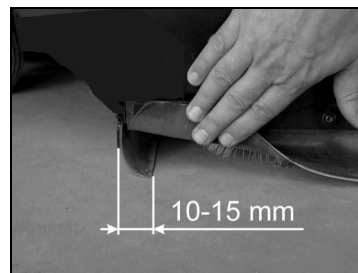

- The clearance of the front sealing strip to the floor must be set so that its whole width folds back with a lag of 10 - 15 mm
- Repeat the adjustment as required

**Note:**

- The sealing strip must be replaced if, due to being too worn, the clearance of the front sealing strip to the floor can no longer be adjusted
- Unscrew the fastening screws and replace the whole sealing strip

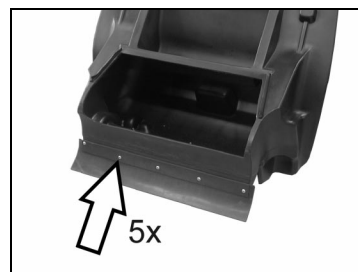

#### Rear sealing strip

- Remove the swept material container
- Undo screws of sealing strip at the debris container
- Replace sealing strip
- Tighten screws of sealing strip

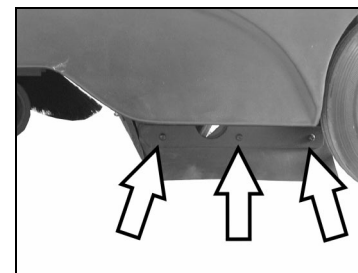

#### Side sealing strips

- Loosen the fastening of the sealing strip
- Replace sealing strip
- To adjust clearance to floor push a 1 - 2 mm thick spacer under it
- Align the sealing strip
- Tighten the fastenings of the sealing strip

### Replace the dust filter



**Danger!**

- Empty and remove debris container prior to starting to replace the dust filter
- Wear a dust protection mask when working on the filter system
- Observe the safety precautions for handling fine dust
- Lock the hand brake



- Remove safety cotter pin of the shaker rod
- Pull out rod.

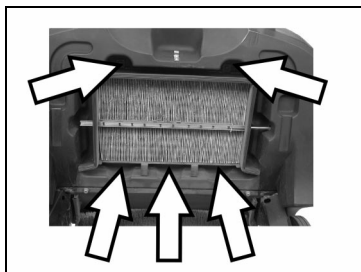

- Loosen fastening screws.



- Remove frame
- Replace the dust filter

**Note:**

Make sure when mounting the new filter that the lamella are not damaged

**Accessories**

**Side brush 6.905-626**

Provided with standard bristles for indoor and outdoor surfaces.

**Soft side broom 6.906-132**

For fine dust on indoor surfaces, resistant to moisture.

**Hard side broom 6.905-625**

For removing stubborn external dirt, damp-proof.

**Standard main brush 6.906-509**

Wearproof and wetproof. Universal bristles for indoor and outdoor cleaning.

**profi main brush 6.906-508**

For the professional application, especially resistant to wear.

**Dust filter 5.731-585**

Wetproof, washable. Filter efficiency > 99,9 %, corresponds to category C of ZH 1/487 of BIA.

**Fault instructions**

**Machine will not start**

- Close unit cover
- Refuel
- Check and clean spark plugs, replace if necessary
- Open the fuel tap
- Notify the Kärcher service station

**Motor running but machine not moving**

- Check belts and chain
- Release push handle lock
- Notify the Kärcher service station

**Machine remains stationary on inclines**

- Select flatter route
- Notify the Kärcher service station

**Machine not sweeping properly**

- Check the main brush and the side brushes
- Check belt for tension and operation; replace, if necessary
- Re-adjust main brush
- Replace the sweep roller
- Notify the Kärcher service station

**Machine making dust**

- De-dust or replace the dust filter
- Empty debris container
- Adjust or replace the sealing strip
- Replace seal at debris container and main brush box

**Poor sweeping around the edges**

- Readjust lowering of the side brush
- Replacing the side broom
- Notify the Kärcher service station

**Raising the side brush does not function**

- Check the Bowden cable of the raising mechanism
- Notify the Kärcher service station

**Technical data**

**Unit data**

**Length x width x height**

1355 x 910 x 1155 mm

**Weight**

126 kg

**Sweeping speed**

4,5 km/h

**Climbing capacity, max.**

18% with the additional brake 2.640-301.0 approved up to a max. of 2% without the additional brake

**Main brush diameter**

250 mm

**Side brush diameter**

410 mm

**Area performance**

3825 m<sup>2</sup>/h

**Maximum operating time per full fuel tank**

1,5 h

**Working width without side brush**

610 mm

**Working width with side brush**

850 mm

**Debris container volume**

50 litres

**Degree of protection**

IPX 3 drip-proof

**Engine**

**Type**

Honda, 1-cyl. four-stroke engine

**Displacement**

135 cm<sup>3</sup>

**Operating speed**

2500 ±100 1/min

**Power output, max.**

3,3 kW/4,5 PS

**Fuel, premium (unleaded)**

Tank capacity 1,1 l

**Engine oil, SF, SG**

0,55 l  
SAE 10W30

**Spark plug, NGK**

BPR 6 ES

**Filter and suction system**

**Dust filter filtering surface**

2,3 m<sup>2</sup>

**Filter application category for non-health hazardous dusts**

L

**Nominal vacuum intake system**

4 mbar

**Intake system nominal volumetric flow**

45 l/s

**Unit vibrations (ISO 5349)**

**Upper limbs**  
2,4 m/s<sup>2</sup>

**Ambient conditions**

**Temperature**  
-5 - +40°C

**Air humidity, non-dew developing**  
0-90%

**Noise emission**  
Sound level (EN 60704-1) 75 dB(A)  
Guaranteed noise level  
(2000/14/EU) 92 dB(A)

**EC conformity declaration**

We hereby declare that the machine specified below as the marketed design, the machine specified below complies with the relevant fundamental safety and health requirements of the EC directives listed below.  
Modification of the machine without our approval invalidates this declaration.

Product: Sweeper

Type: 1.351-xxx

**Relevant EC directives**

EC machine directive (98/37/EC)  
EC directive on electromagnetic compatibility (89/336/EEC) amended by 91/263/EEC, 92/31/EEC, 93/68/EEC  
EC guideline on noise emissions (2000/14/EU)

**Applied harmonised standards**

DIN EN 60335-1  
DIN EN 60335-2-72  
DIN EN 50082-2:1994

**Applied national standards**

CISPR 12

**Applied conformity valuation method**

Appendix V

Measured noise level:  
90 dB(A)

Guaranteed noise level:  
92 dB(A)

Internal measures ensure that the in series produced units always comply with the requirements of current EC directives and applied standards. The signatories act for and in authority of management.

5.957-708 (04/02)

Alfred Kärcher Limited Partnership.  
Registered office: Winnenden.  
Company Register: Waiblingen, HRA 169.  
Personally liable partner. Kärcher Reinigungstechnik GmbH.  
Registered office Winnenden, 2404 Waiblingen Company Register, HRB

Managing directors:  
Dr. Bernhard Graf, Hartmut Jenner,  
Georg Metz, Thomas Schöbinger

Alfred Kärcher GmbH & Co.  
Cleaning Systems  
Alfred-Kärcher-Strasse 28-40  
P.O.Box 160  
D-71349 Winnenden  
Phone: ++49 7195 14-0  
Fax :++49 7195 14-2212

  
( Reiser Jenner )



# KM 85/50 W B

**KÄRCHER** KM 85/50 W B  
1.351-105.0

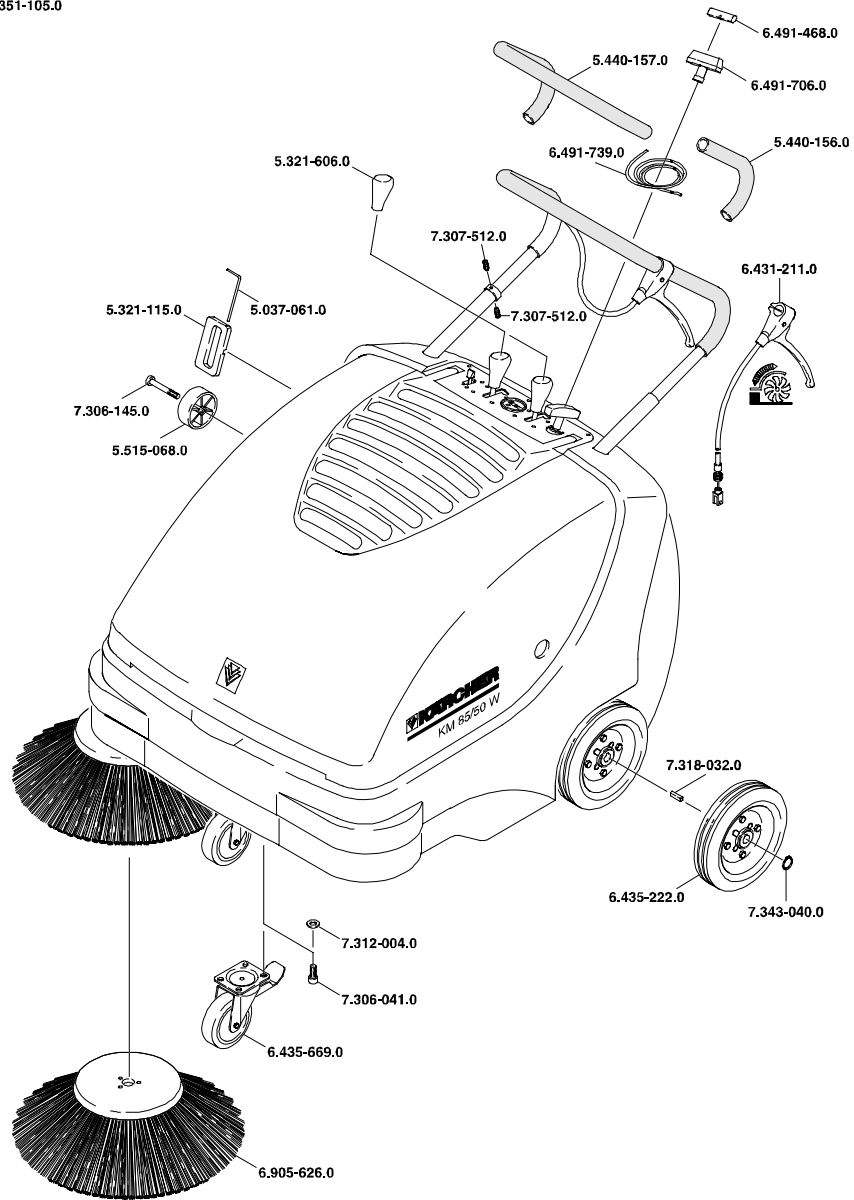

05.2002

**KÄRCHER** KM 85/50 W B  
1.351-105.0

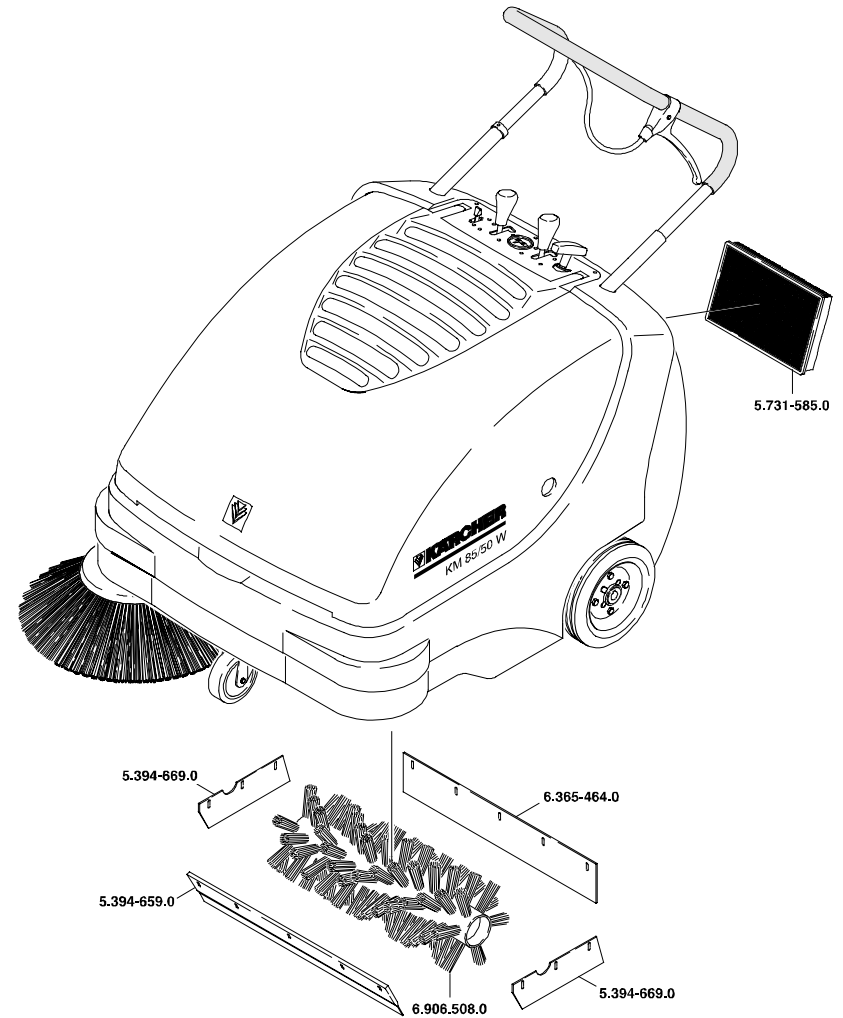

5.970-052.0 /2 05.2002

## Free Manuals Download Website

<http://myh66.com>

<http://usermanuals.us>

<http://www.somanuals.com>

<http://www.4manuals.cc>

<http://www.manual-lib.com>

<http://www.404manual.com>

<http://www.luxmanual.com>

<http://aubethermostatmanual.com>

Golf course search by state

<http://golfingnear.com>

Email search by domain

<http://emailbydomain.com>

Auto manuals search

<http://auto.somanuals.com>

TV manuals search

<http://tv.somanuals.com>