



R E F E R E N C E

OWNERS MANUAL

Model 201/2 Model 202/2c Model 203/2 Model 204/2c Model 205/2 Model 206/2ds Model 207/2

Important Safety Information

Thank you for purchasing KEF Reference Series loudspeakers. These have been designed to faithfully reproduce high quality sound over many years of use and should provide realistic reproduction of music and speech. Please take a little time to read these instructions prior to use.

Your KEF Reference Loudspeakers are tall, slim and extremely heavy. Installed correctly on a smooth, level surface, your loudspeakers should be entirely safe to listen to and to live with.

However, if you have small children, large pets, the infirm, uneven flooring or unusually thick carpeting in your home, then correct adjustment of the foot assemblies is imperative, if safe, stable operation is to be achieved.

Warning: The metal tweeter dome now has protective mesh at the centre of the Uni-Q® driver array; if however this is compromised and the dome itself is dented, it will permanently impair performance.

1. Read this manual carefully, especially the safety information, before attempting to assemble and operate the system.
2. Follow the unpacking and assembly instructions on the cartons. Please note that lifting the heavier Model 207/2 and Model 204/2c requires two able-bodied persons.
3. Never connect the system directly to the electricity supply.
4. Trailing cables are dangerous. Ensure all cables are secure and tidy.
5. When stripping cables use only tools designed specifically for the purpose ie: correct wire cutters or cable strippers. Do not attempt to strip cables with a knife as this could result in serious injury.

General Care of your System

1. **Avoid temperature extremes.**
2. **Avoid damp.**
3. **Avoid direct sunlight.**
4. **Clean with the KEF cloth provided.**
5. **Do not use spirit based cleaners.** 

If you are at all uncertain about setting up, operating or caring for your system your dealer will be pleased to assist you.





Correct

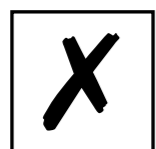

Wrong

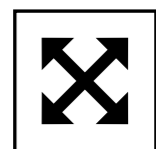

Adjustment

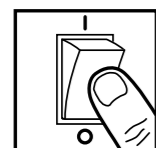

Switch off appliance



Caution/Warning

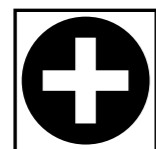

Positive/RED

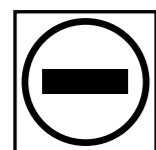

Negative/BLACK



Option

Contents

Important Safety Information	1
General Care of Your System	1
Contents	3
Introduction	5
Overview of Common Features	6
Model 207/2	7
Model 205/2	7
Model 203/2	7
Model 201/2	8
Model 206/2ds	8
Model 202/2c	8
Model 204/2c	8
Installation and Operation	9
Unpacking, Handling and Aftercare	9
Adjusting the Feet and/or Spikes	10
Loudspeaker Placement and Room Acoustics	11
Loudspeaker Positioning	12
Amplifier to Loudspeaker Connections	14
Amplifier Requirements and Power Handling	14
Uni Balance Adjustment Models 201/2, 203/2, 205/2, 207/2, 206/2ds	15
Placement Adjustment Models 202/2c, 204/2c	17
Single, Bi and Tri-wire Connections	18
Loudspeaker Cables	23
Grilles	23
Warranty	23
Service Information	23
Specifications	24
KEF Heritage	29



Introduction

Since its formation in 1961, KEF has pioneered many innovations in loudspeaker technology and design. Your new Reference Series loudspeakers contain one of the latest of these advances - the KEF 'Project Austin' Uni-Q driver array.

In this innovative KEF design, not only are the mid and high-frequency drivers on the same axis (co-axial), but their acoustic centres are also on the same plane (co-planar). The profile of the mid-frequency driver's cone modifies the directivity factor (or 'Q') of the high frequency unit such that both drive units have the same directivity in the critical crossover region, where they are operating at similar frequencies. This unification of the 'Q' of the drive units lies behind the name "Uni-Q".

Now incorporated in many KEF loudspeakers, the Uni-Q driver array yields immediate and readily audible sonic benefits. With no sharp discontinuity in 'Q' at the crossover frequency, correct tonal balance is not confined to a single 'sweet spot' in the listening room and is extended to cover a far broader area. With sound arriving in phase, the sound source is brought into the sharpest possible focus. With properly recorded material and as part of a good quality system, well set-up, loudspeakers with KEF Uni-Q can reveal the location of each musical voice in the stereo image with pin-point accuracy and with a much smoother response being maintained off-axis - where most people listen - than before.

The latest Uni-Q array implemented in this range is a sophisticated device offering a combination of wider bandwidth and wider dispersion than its predecessor.

Both the midrange and high frequency drivers have been symbiotically designed to take us one step closer to the ideal of a controlled directivity point source acoustic radiating system. The 165mm (6.5in.) midrange section has a shallow 'Uni-Form' cone profile which gives excellent midrange performance but also provides the optimum waveguide for the coincidentally mounted tweeter.

This new two piece 25mm (1in.) titanium dome tweeter has been developed utilising Finite Elements Analysis techniques to provide 'piston' motion to a much higher frequency, eliminating the need for a separate hyper-tweeter.

It also features a vented pole piece, increasing the air space behind the dome providing an extended but smooth high frequency performance whilst retaining ultra wide bandwidth source compatibility: DVD-A/SACD.

Overview of Common Features of KEF Reference

The KEF Reference Series products covered by this manual are loudspeakers designed primarily to operate away from room boundaries (free space), where the renowned stereo imaging of the Uni-Q driver array is at its best. However, a bass level adjustment is provided (Uni Balance) on all Reference Series Models which corrects the response to allow for placement close to a wall.

In addition, all the models listed feature a four step independent HF adjustment (also accessed via the Uni Balance terminals) to allow further tailoring to a particular acoustic environment or to allow for the presentation of accompanying electronics.

All models use Reference matched drive units and crossovers that have been manufactured to laboratory-standards and rigorously tested at every stage of production. The driver complement of each system reflects the increasing performance capabilities of each model, particularly its ability to reproduce wider bandwidth at higher output levels.

Independent Driver Loading (IDL) is utilised for the bass sections of this new Reference Range. Using two identical bass units rather than a single larger one has the advantage of maintaining a slim profile for the cabinet and subsequently wide and even sound dispersion. Internally, however, a tall slim enclosure suffers from strong top-to-bottom acoustic standing waves which are very difficult to control.

IDL divides the enclosure into two half-height enclosures, one for each bass driver, with much improved internal acoustics.

Thanks to their internal Magnetic Shielding, these loudspeakers may be used close-to or beside a television set or video monitor, when used in front left and right channel positions in Home Theatre or Surround Sound applications.

The centre loudspeakers also include a bass adjustment for TV or wall mounting, plus a high frequency boost facility for when they need to be mounted behind an acoustically transparent screen.

All models are timbre matched to each other so combining different models in an AV system is no problem. Extra Reference loudspeakers can be added to your system with the knowledge that the system tonal balance and integration will be maintained.

Wide entry, gold-plated tri-wire/tri-amp terminals are fitted to the custom-designed moulded terminal assembly at the rear of the loudspeaker cabinet. This allows the use of the many different gauges of loudspeaker cable that are available.

Model 207/2

The flagship of the new KEF Reference range, Model 207/2 is designed to faithfully reproduce the full bandwidth and dynamics of music signals. It is a no compromise design where acoustic performance is the prime objective.

A complex, fully fourth order, high-quality, hand-soldered dividing network and five drive units are utilised in the Model 207/2.

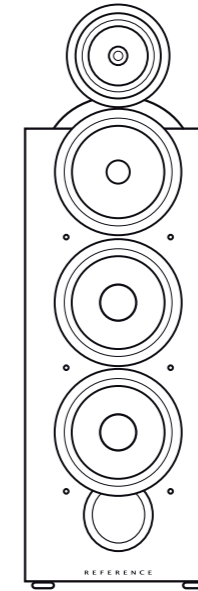

The dividing network has its cross-over points at 120Hz, 400Hz and 2.3kHz and smoothly directs appropriate frequencies to the relevant drive units. The new 165mm (6.5in.) Reference Series Uni-Q driver array is used here for upper mid, high and very high frequencies. A 250mm (10in.) lower mid-range unit fitted within its own individual compartment and two 250mm (10in.) fibre reinforced pulp-cone bass units, mounted in IDL (Independent Driver Loading) configuration, complete the driver complement.

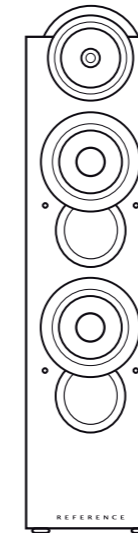

Model 205/2

Four drive units in a three-way configuration are employed in the Model 205/2. The single Uni-Q driver array for upper mid-range and high frequencies with ultrasonic extension, and a pair of 200mm (8in.) drive units in IDL configuration for low frequencies. This system works optimally in medium to large rooms where its controlled and extended bass lays a strong foundation to the superior imaging of the Uni-Q driver array.

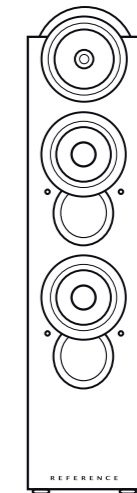

Model 203/2

Model 203/2 is a floorstanding three-way loudspeaker with four drive units designed for high quality reproduction in medium sized rooms or where space is limited. Two 165mm (6.5in.) drive units in IDL configuration handle bass frequencies, the mid-range and high frequencies are handled by the Uni-Q driver array extending the response smoothly into the ultrasonic region.

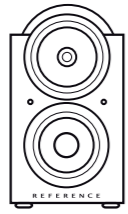

Model 201/2

This is a three-way loudspeaker designed primarily for high quality reproduction as a main loudspeaker in small rooms or as a high quality satellite loudspeaker in AV systems where space is at a premium. Model 201/2 has three drive units, two of which are combined in the single 165mm (6.5in.) Uni-Q driver array, with a 165mm (6.5in.) fibre reinforced pulp cone bass unit mounted in a reflex enclosure, completing the driver line up.

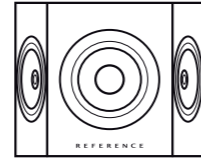

Model 206/2ds

The Model 206/2ds is a dedicated dipole rear surround loudspeaker for KEF Reference multi-channel systems. Incorporating two Reference Series Uni-Q driver arrays and an additional 200mm (8in.) ultra low distortion bass driver, the Model 206/2ds is perfectly timbre matched with the other Reference Series loudspeakers.

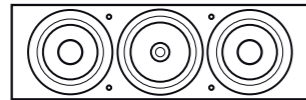

Model 202/2c

Model 202/2c is a centre channel loudspeaker designed primarily to match the Model 201/2 and Model 203/2 main loudspeakers and smaller screens. It uses the same drive unit complement as the Model 203/2 and, like the larger Model 204/2c is timbre matched to the other Reference Series loudspeakers thereby allowing a seamlessly integrated 3D soundstage to be set up in the listening room. The size has been chosen to allow it to be mounted more conveniently underneath the screen within the typical dimensions of a 32in. widescreen TV or panel stand.

Models 202/2c and 204/2c have magnetically shielded drive units and crossover networks thus minimising any interference with CRT type televisions.

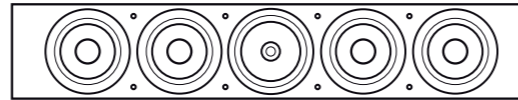

Model 204/2c

Truly a statement centre channel loudspeaker, the Model 204/2c fully exploits the dynamics and bandwidth of modern AV soundtracks. With around 70% of a typical soundtrack coming from the centre channel it makes sense to make this loudspeaker a truly capable one. Four 165mm (6.5in.) LF units combine with the 165mm (6.5in.) Uni-Q driver array in a three way reflex system which, like the Model 202/2c, not only has a bass level adjustment for close to wall mounting but also a treble boost facility for mounting behind an acoustically transparent screen.

Four specialised rubber feet or bumpers are firmly fixed to the base during production to make sitting easier straight from the box. In addition, dedicated stands are available for the Model 202/2c and Model 204/2c centre loudspeakers which allows them to be securely mounted for optimum performance in free space.

Installation and Operation

Unpacking, Handling and Aftercare

These Reference Series loudspeakers are packed one loudspeaker per carton. Prior to unpacking, please ensure that the serial numbers of the loudspeakers supplied match each other. Then, unpack the loudspeakers carefully and inspect for any sign of damage. Your loudspeakers left KEF in perfect condition. If any damage is apparent, you should notify your retailer or consultant immediately. Retain the packaging in case a need arises for you to transport the loudspeakers at a later date.

You will notice that a special KEF care-pack is included with each pair of loudspeakers. This pack contains a cleaning cloth and all the required accessories for connecting and positioning your loudspeakers. The care pack also contains the unique product build certificate. This is a valuable document and guarantees the quality and craftsmanship of your loudspeakers.

The cabinets are finished in real wood veneer and should be treated with the same care with which you would treat fine furniture. A suitable cleaning cloth is included in the customer care pack to maintain the original finish and lustre.

It is normal for the appearance of wood veneer to change with the passing of time, but locations in direct sunlight should, if possible, be avoided. Furthermore the cabinets should not be allowed to become wet.

Each Reference Series floorstanding loudspeaker is supplied with KEF designed substantial spikes and locking nuts (also in the care pack). This enables fine adjustment of level, depending on your preferred location of the loudspeakers whatever the floor covering, carpet, tile or block wood. In addition to the spikes and locking nuts each Model 207/2 also comes with castors.

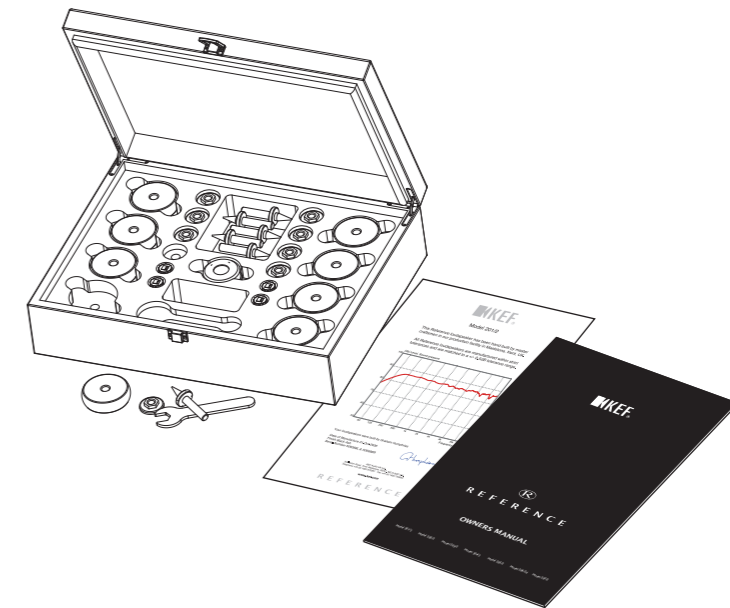

Adjusting the Feet and/or Spikes

Under normal circumstances your loudspeakers will be commissioned by your retailer or consultant, who will have been trained in their installation by KEF.

KEF strongly recommend that you do not attempt to level your loudspeakers single-handed.

Recruit the assistance of another adult - or consult an authorised KEF Reference outlet for assistance which may be chargeable if the purchase was not made through them originally.

The spike/locking nut combination supplied is designed to provide small adjustments, not to compensate for seriously irregular floors. A spirit level is provided with certain models to gauge when the loudspeaker is perfectly level.

A rigidly-sited loudspeaker performs better than one that can move because it enables the cabinet to remain fixed while the drive units are allowed to move as determined by the source signal.

Best results will be obtained if the loudspeakers are level and stable. Check the general stability of each loudspeaker by gently rocking it from side to side, front-to-back and diagonally. Often, you will find that the loudspeaker is close to vertical, but rocks because one spike (or two spikes diagonally) seems too short.

If the general stability is good, but the loudspeaker is leaning to left, right, backward or forward, then equal minor adjustments to the two spikes opposite to the direction of lean should be made.

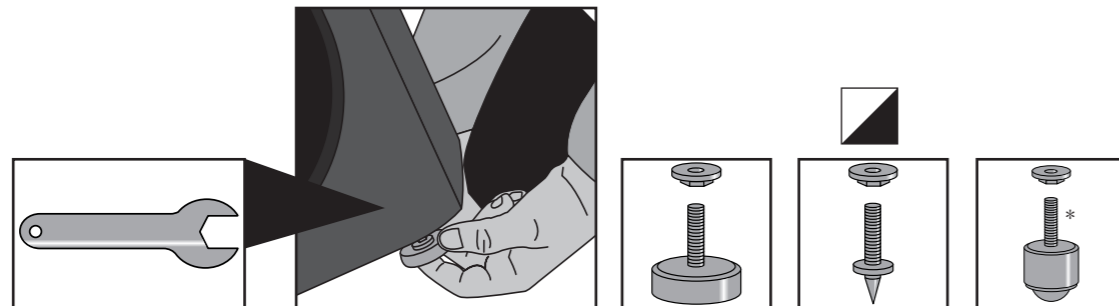

* Only supplied with Model 207/2

Loudspeaker Placement and Room Acoustics

The listening room is one of the most variable elements in the hi-fi chain and its effect cannot be emphasised too strongly, nor can its effects be reliably predicted. Spacing the loudspeakers approximately 2m - 3m (6ft. - 10ft.) apart will allow the stereo images to develop fully. You should sit at a distance at least equal to and preferably greater than the distance between the loudspeakers.

Positioning the loudspeaker in a corner or near to a side wall is not recommended as the significant bass boost caused by this position will affect the sound and cause the stereo image to deteriorate. However, placement close to the front wall is catered for in the Uni Balance feature (see later). It is best to place the loudspeakers symmetrically within the room,

relative to the walls, ceiling and floor, where possible.

Be aware also that soft furnishings near to a loudspeaker will deaden the sound - similarly, nearby reflective surfaces may brighten up the sound. Move the loudspeakers until you are satisfied that the sound is right and that the stereo image is well defined.

Like all other KEF Uni-Q loudspeakers, your Reference Series loudspeakers are designed to be used with little or no 'toe-in'. However if required a 'brighter', or 'sharper' sound may be obtained by pointing the loudspeakers directly towards the listening position or adjusting the HF output (via Uni Balance).

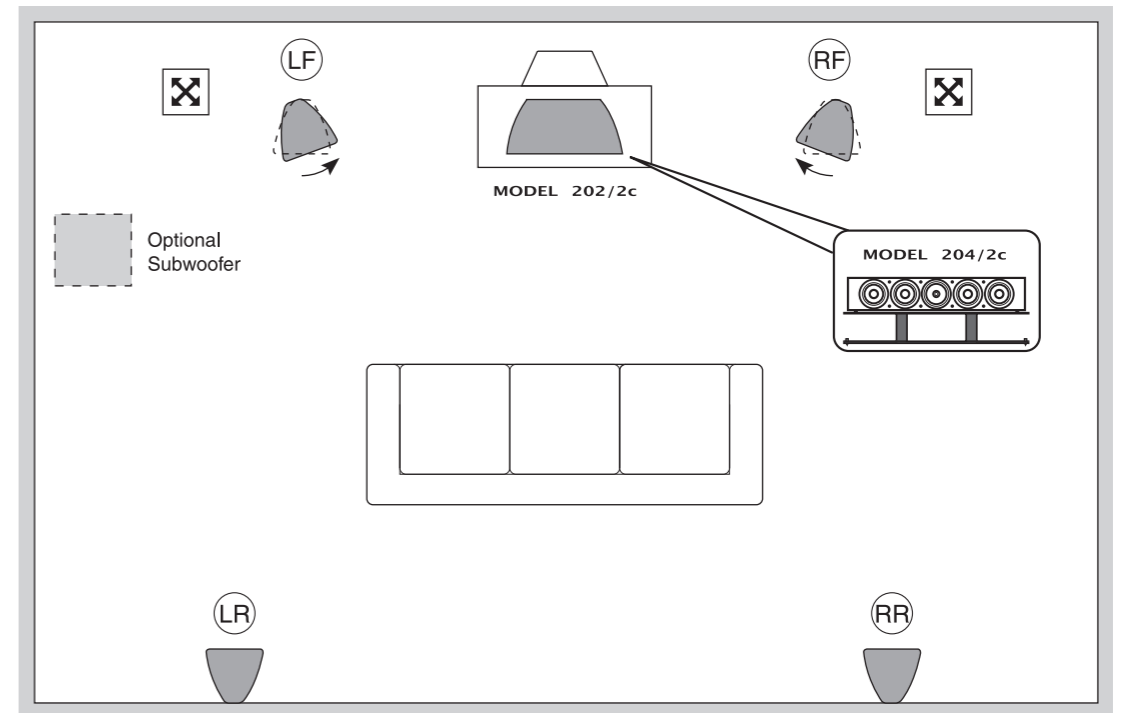
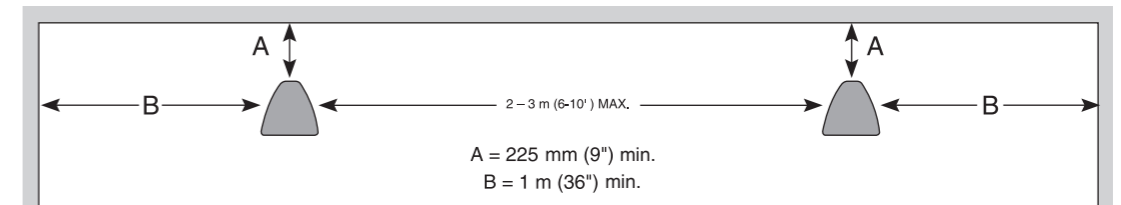

LF RF } MODEL 201/2
MODEL 203/2
MODEL 205/2
LR RR } MODEL 207/2

Loudspeaker Positioning

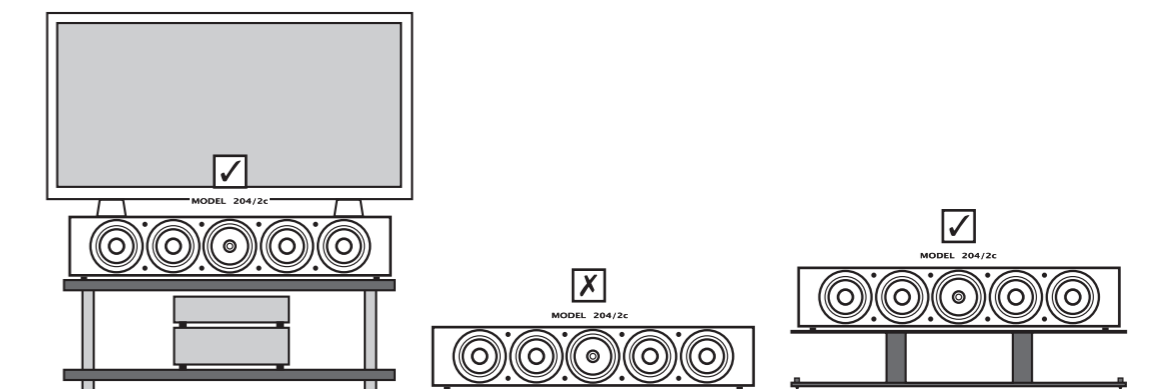
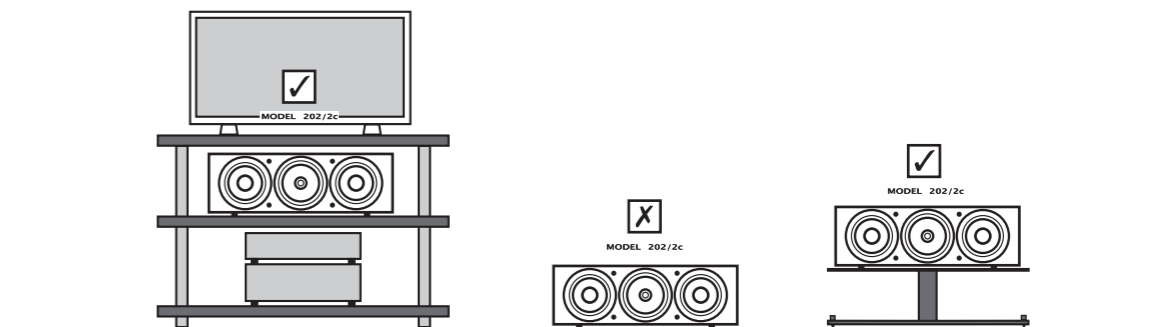
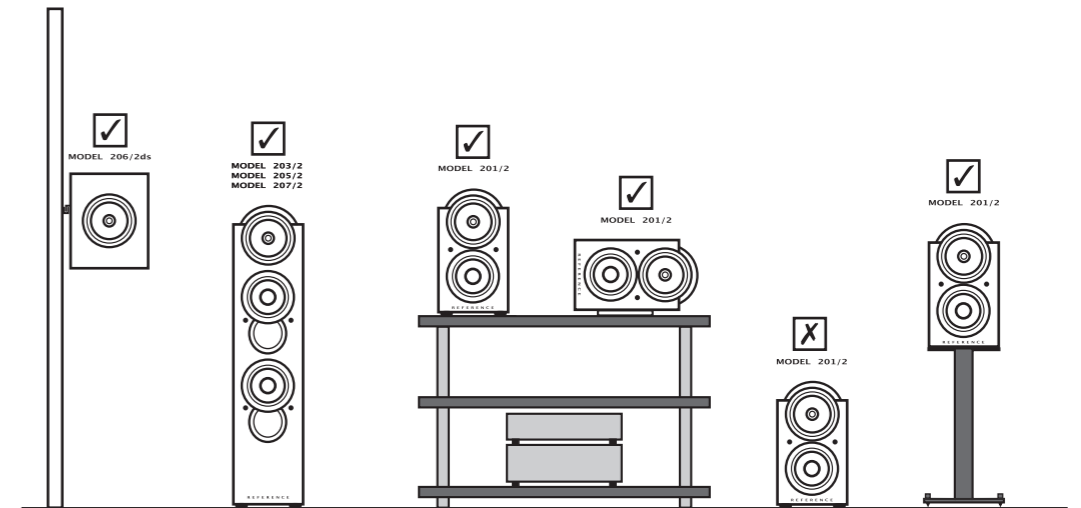
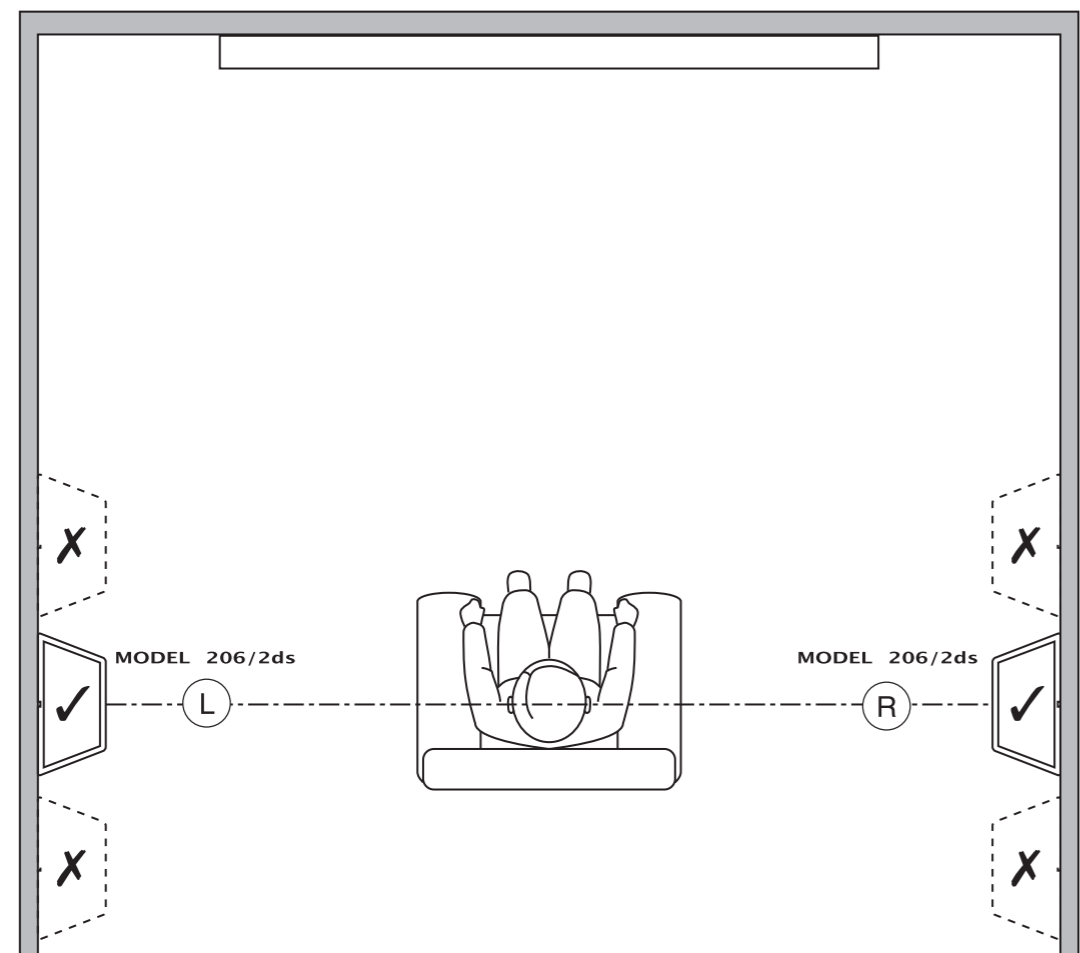
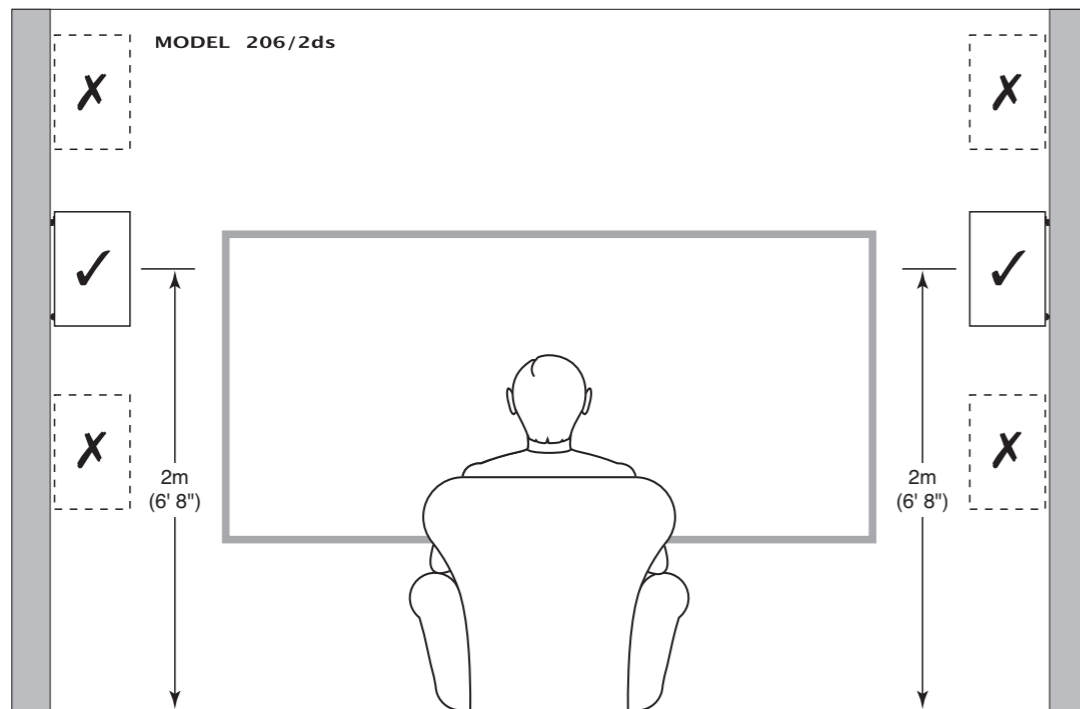

Amplifier to Loudspeaker Connections

All connections should be made with the amplifier switched OFF. Ensure the integrity of all connections prior to switching the amplifier ON.

KEF Reference Series loudspeakers are fitted with purpose designed gold-plated Tri-wire/Tri-amp terminals which will accept bare wire, spade or 4mm connectors.

Most good quality loudspeaker cables have some indication, such as colour coding or 'ribbing' on the insulating material, indicating which conductor is '+' or positive. Connection to the loudspeakers can then be made as follows:

The left channel amplifier output terminal marked '+' or coloured RED connects to the left loudspeaker terminal marked '+'. The left channel amplifier output terminal marked '-' or coloured BLACK connects to the left loudspeaker terminal marked '-'. Similarly, these instructions should be followed for making connections between the right channel amplifier output and the right loudspeaker. Correct polarity, or phase, is vital to the proper operation of the system.

If the connections are not made correctly the sound will deteriorate giving poor bass output and a diffuse presentation of the soundstage.

Bare wire connections are the simplest to achieve and involve stripping 12.5mm (1.2in.) of insulation to expose the loudspeaker wire core. (You should twist together, using clean fingers, the ends of each multi-stranded core prior to the next stage to ensure a good signal contact). Having unscrewed the lower terminal cap, push the wire through the exposed hole in the terminal body and screw the cap down tightly.

Make sure that no stray strands come into contact with the opposite terminal; this could cause a short circuit between the terminals and may damage your amplifier.

Be aware that a higher quality run of cable will always give a more rewarding presentation than multiple runs of an inferior cable.

Amplifier Requirements and Power Handling

In KEF literature and in the specification table within these instructions are listed a range of amplifier power outputs to match your Reference Series loudspeakers. Conditions of use (room size, type of programme, preferred listening level) and the nature of the loudspeaker/amplifier interface vary so widely that it is not possible to lay down hard and fast rules about amplifiers and the loudspeakers they drive.

KEF loudspeakers are built to rigorous standards of quality and consistency and the upper limits of the amplifier requirements shown are those which the loudspeaker in question should handle without distress or damage when used under normal domestic conditions.

If higher than specified amplifier powers are used, great care should be taken to avoid abnormal conditions such as switch-on surges or

gross distortion, either of the amplifier or the loudspeaker, resulting in power peaks greatly in excess of the ratings specified. Care should be taken as the possibility still exists under certain conditions (such as excessive bass or treble boost caused by tone and/or loudness controls, graphic equalisers, etc.) that the loudspeakers can be overloaded and damaged. The lower limits of amplifier power are those necessary to give a reasonable sound pressure level under domestic conditions.

Remember it is easier to damage the loudspeaker by using a small amplifier driven into distortion by too much volume, possibly with bass and treble boost, than by using a larger amplifier which has power in reserve.

If in doubt, ask the advice of your retailer or consultant.

Uni Balance Adjustment

Models 201/2, 203/2, 205/2, 207/2 and 206/2ds

Models 201/2, 203/2, 205/2, 207/2 and 206/2ds incorporate separate adjustments for bass and treble output situated at the top of the terminal panel (see below). The left hand terminal allows a two position bass level adjustment while the centre and right hand terminals

allow a four position tweeter level setting. Three gold plated screw caps are supplied with each loudspeaker, one for the LF and two for the HF adjustment.

LF Adjustment

With the supplied cap screwed into the 'LF Adjust' terminal the bass level is set at the 'flat' setting - for free space positioning. When a loudspeaker is positioned close to a wall the perceived bass level is increased by approximately 2dB.

If the cap is removed from the LF Adjust terminal the bass level is reduced to correct the loudspeaker response for the proximity of the wall.

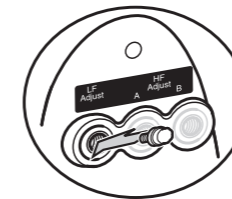

1. Flat cap in

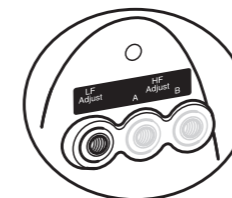

2. Cut cap out

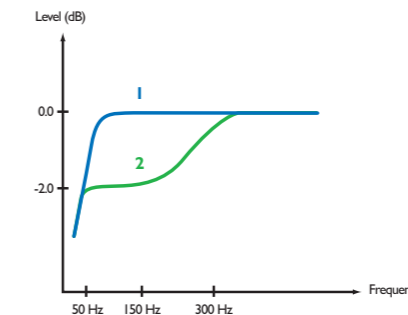

Mode	LF level (dB)
1. cap in	0.0
2. cap out	-2.0

HF Adjustment

The 'HF Adjust' A and B terminals control the high frequency output of the loudspeaker. This facility allows the user to adjust the 'brightness' of the loudspeaker to suit listening room acoustics, partnering electronics and personal taste.

Four settings for tweeter output level are possible +0.75, 0 ('flat'), -0.75 and -1.5dB. For a 'brighter' or 'sharper' sound select +0.75, to remove brightness select -0.75 or -1.5dB. The adjustment is made by screwing one, both or neither of the gold plated screw caps into the HF Adjust 'A' and 'B' terminals, according to the table below. The default setting is 0 ('flat') - one screw cap in terminal 'B'.

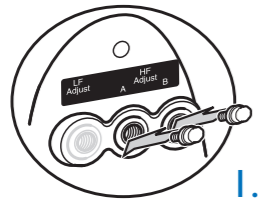

1.

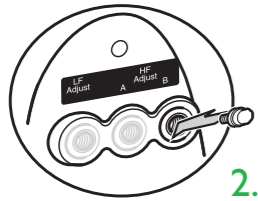

2.

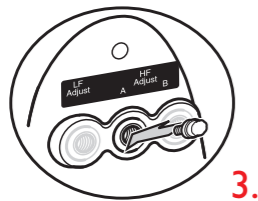

3.

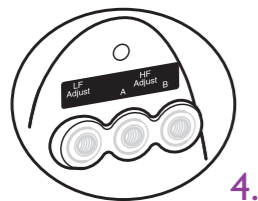

4.

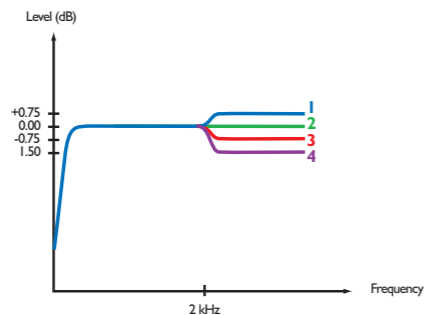

Mode	Cap		HF level (dB)
	A	B	
1.	in	in	+0.75
2.	out	in	0.00
3.	in	out	-0.75
4.	out	out	-1.50

These adjustments as mentioned earlier are provided not only for 'room tuning' but to allow a more sympathetic partnering to some electronics.

Amplifiers that may have either a very forward or bright presentation can be tamed or equally those that have quite a warm presentation can be given extra sparkle, it is your choice.

Placement Adjustment Models 202/2c and 204/2c

LF Adjustment

The two centre channel loudspeakers, Models 202/2c and 204/2c, incorporate a two position 'Free Space/Television' Uni Balance that adjusts the bass level depending on whether the loudspeaker is mounted freestanding or close to a TV or wall boundary. In the Model 202/2c the

'television' setting corrects the bass response for when the loudspeaker is placed on top of, or directly underneath, a TV. In the Model 204/2c the 'television' setting corrects the bass response for when the loudspeaker is placed on a stand close to a wall.

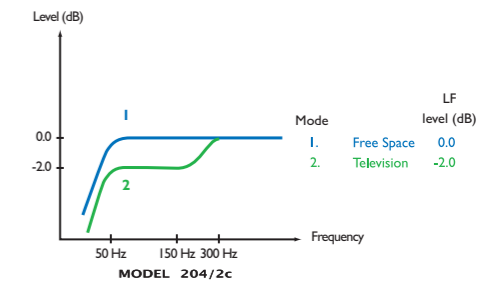
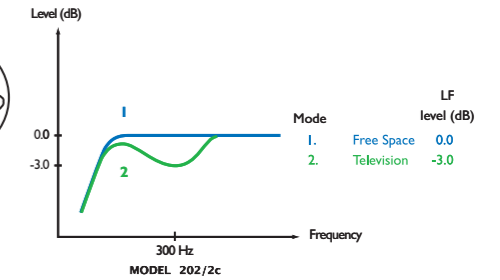
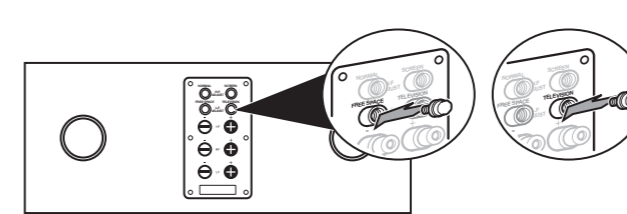

HF Adjustment Models 202/2c and 204/2c

The two centre loudspeakers Models 202/2c and 204/2c incorporate a two position high frequency level adjustment which allows compensation for the sound attenuation when

the loudspeaker is positioned behind a typical acoustically transparent projection screen, see below. Select 'Screen' when the loudspeaker is positioned behind a screen.

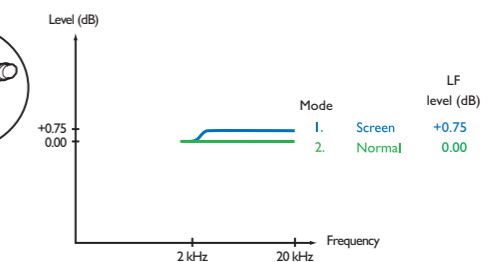
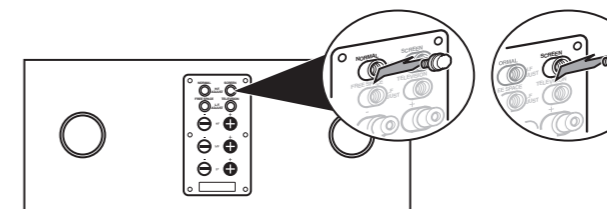

Single, Bi and Tri-wire Connections

Tri-wiring/Tri-amping Terminals

The three sets of input terminals are linked by a high quality shorting cable. Removal of this cable will allow the LF, MF and HF sections to be connected separately, either by a parallel connection from one amplifier (known as tri-wiring) or to separate power amplifiers

driven from the same pre-amplifier (tri-amping). Further adjustment of this cable will allow connection of just two (pairs of) adjacent terminals together for Bi-wiring and Bi-amping.

Attaching Shorting Links

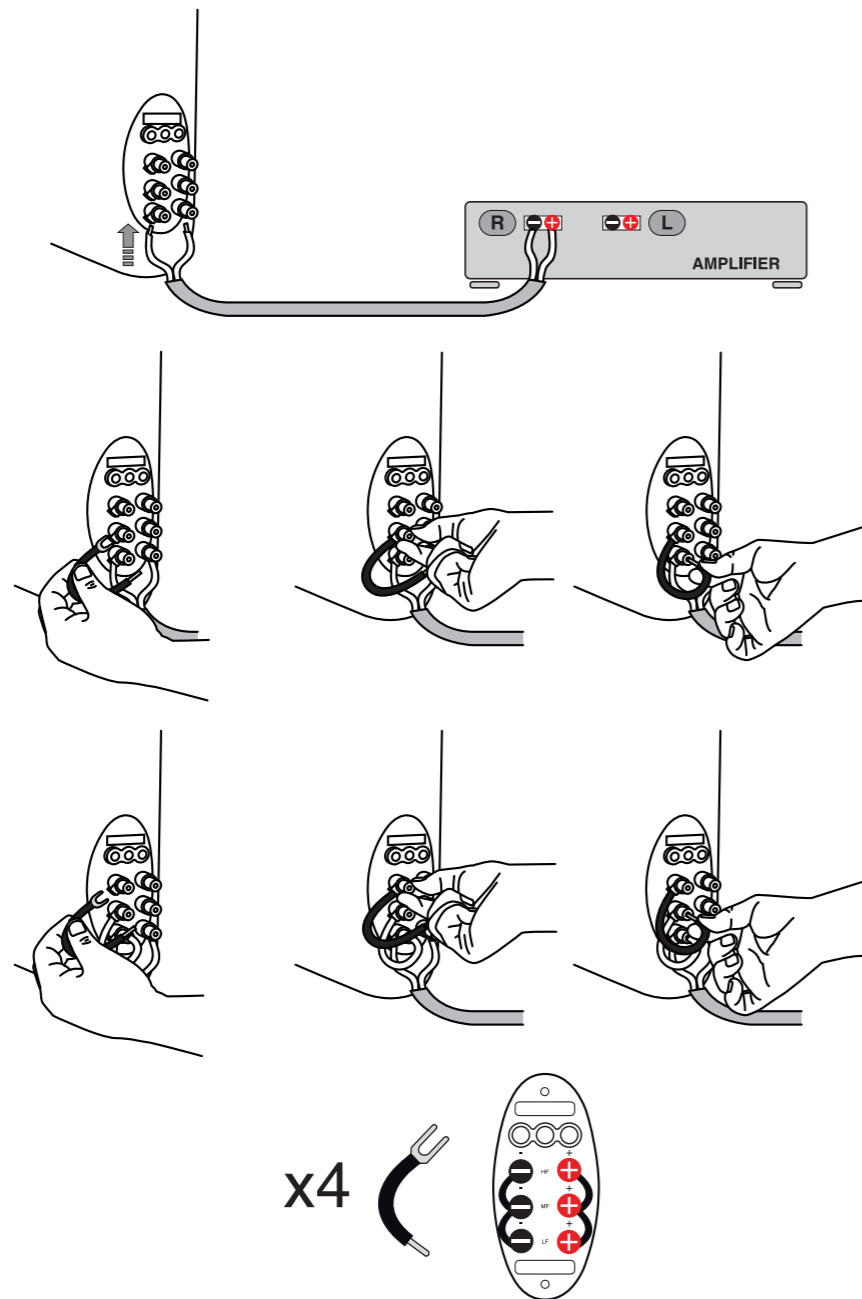

Loudspeaker single wire connections

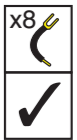
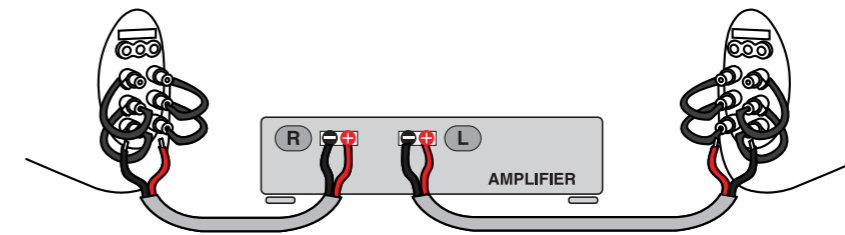

Loudspeaker bi-wire connections

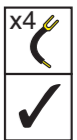
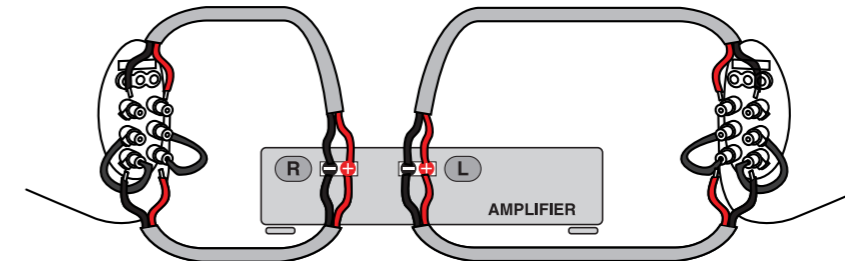

Loudspeaker tri-wire connections

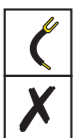
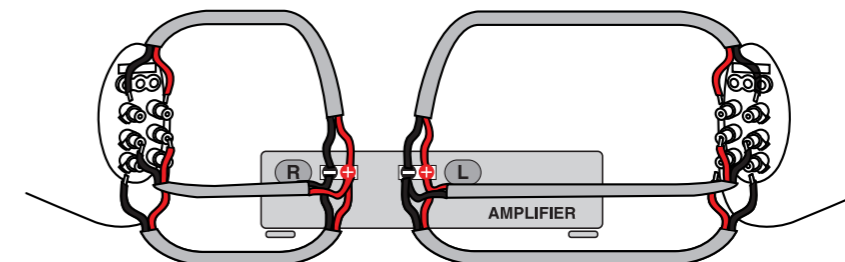

Centre loudspeaker single wire connections

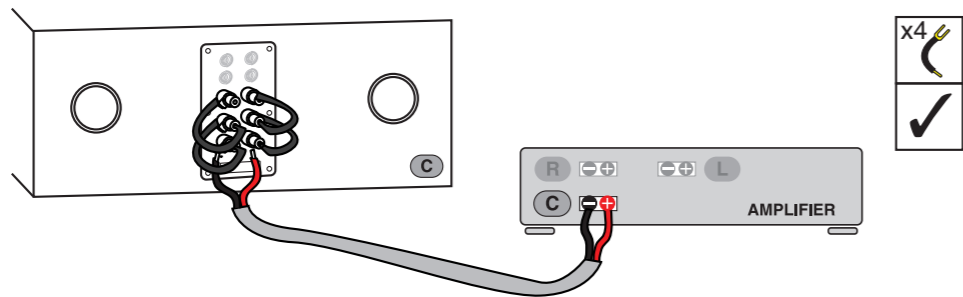

Centre loudspeaker bi-wire connections

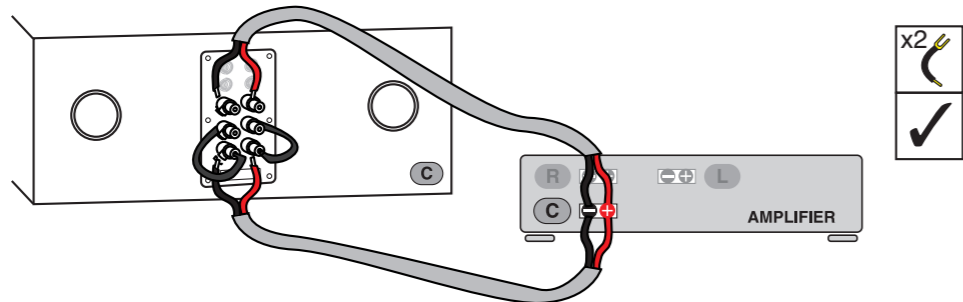

Centre loudspeaker tri-wire connections

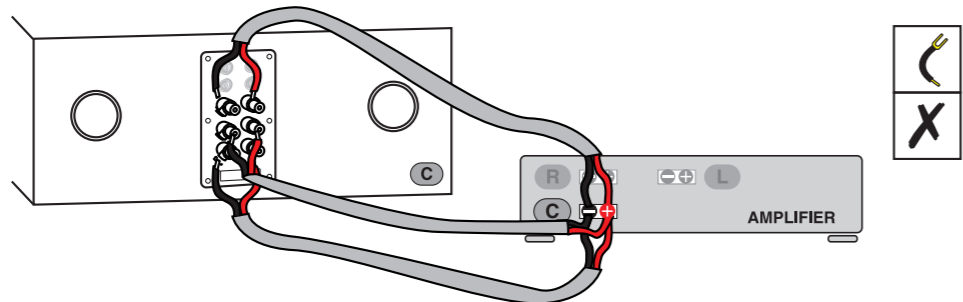

Loudspeaker single amplification connections

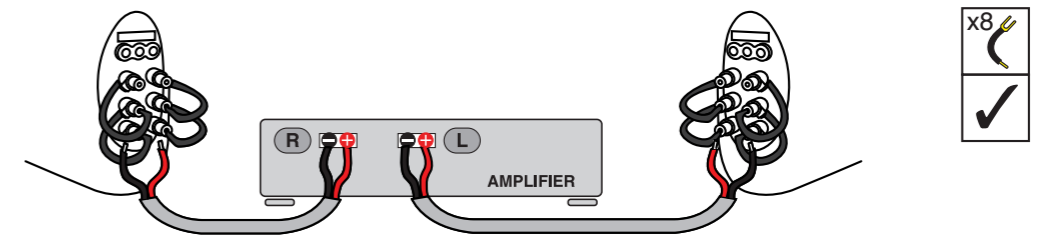

Loudspeaker bi-amplification connections

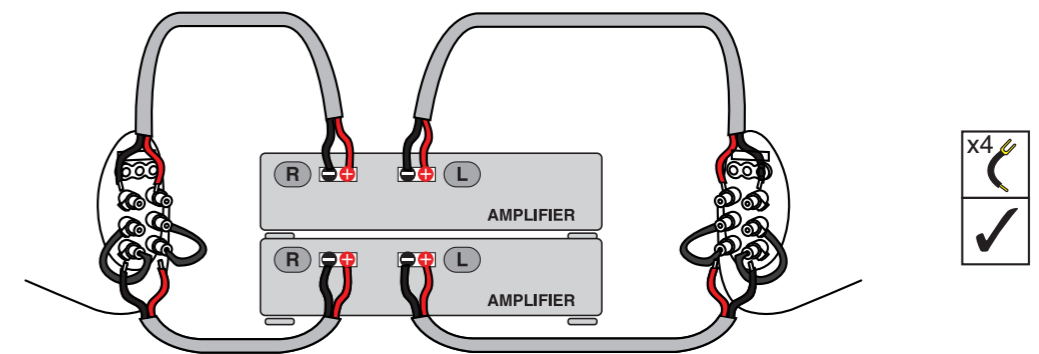

Loudspeaker tri-amplification connections

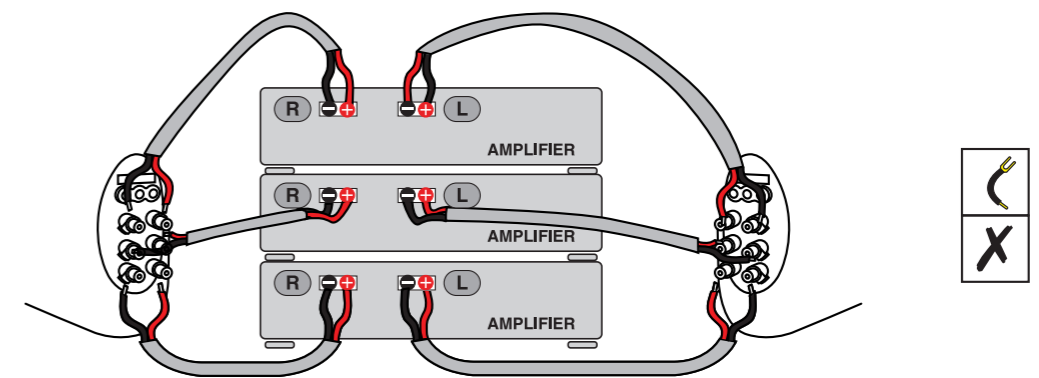

Centre loudspeaker single amplification connections

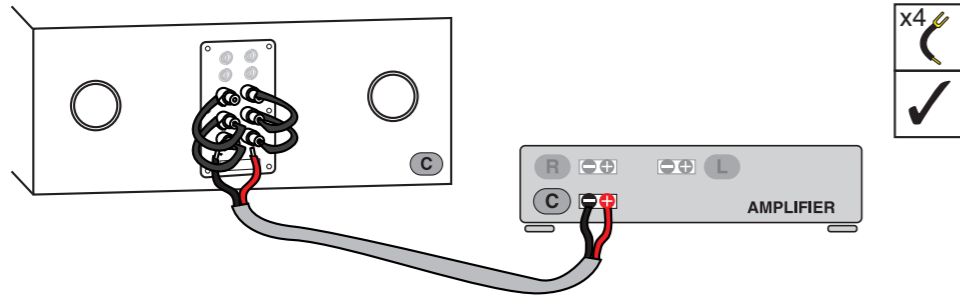

Centre loudspeaker bi-amplification connections

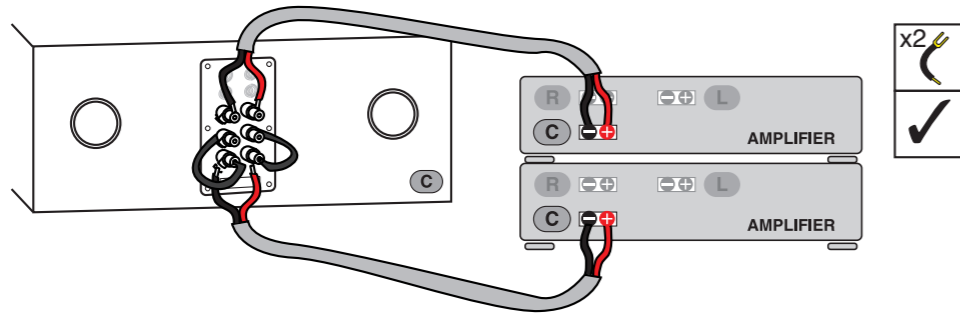

Centre loudspeaker tri-amplification connections

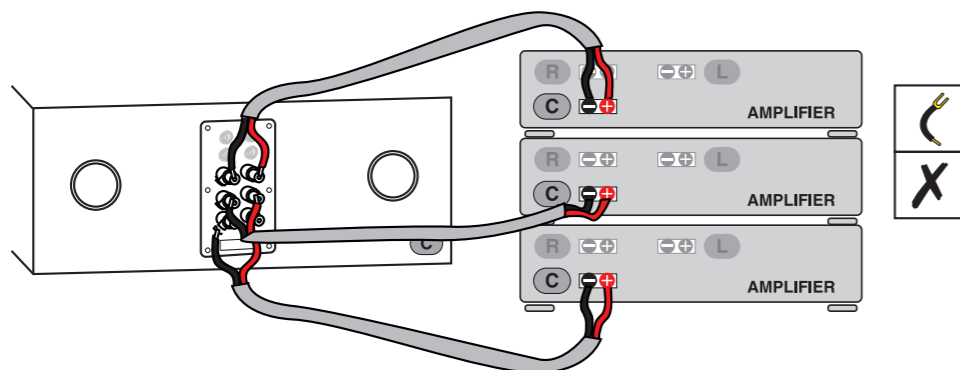

Loudspeaker Cables

Poor quality cables can seriously compromise the overall sound of your hi-fi system. KEF recommends that high quality loudspeaker cable be used for connecting your Reference Series loudspeakers. It is good practice to keep the cables as short as possible.

The left and right channel loudspeaker cables should, wherever possible, be the same length otherwise there may be a perceptible change in output level between the loudspeakers.

Grilles

Dedicated grille assemblies are factory fitted to each loudspeaker. However, if you wish you may remove the grille by gently pulling it forward toward you. The grille is held on via 'pegs' that locate into the front baffle grille-peg sockets (or magnets which hold the top Uni-Q driver array grille). If required, the grilles may be removed during use, but KEF recommends replacement following use.

KEF suggest removal of the grille for serious listening. For cleaning purposes, the grilles should be removed from the cabinets and brushed lightly with a soft brush. Alternatively, use a variable suction vacuum cleaner, with soft brush attachment.

Warranty

Your KEF Reference Series loudspeakers are guaranteed against manufacturing defects in both materials and workmanship. For further details of how this guarantee affects you, please read the enclosed Warranty leaflet.

It should be noted, however, that failure of the loudspeaker due to abuse, improper or inappropriate use and/or operation or damage caused by other faults in your system are NOT covered within the terms of the guarantee.

Service Information

Loudspeakers are inherently reliable and rarely give trouble. It is important to remember that faults arising in any part of the reproducing system will be heard via the loudspeakers and therefore when faults occur, careful and analytical diagnosis will be required to locate the actual source of trouble.

Service problems should be discussed in the first instance with the dealer from whom the loudspeakers were originally purchased. Generally, warranty claims are best handled by your dealer. However, in case of difficulty, please contact:

Loudspeakers cannot generate hiss or hum. Spurious noises of this type generally originate in the electronic sections of the equipment or even in the programme source itself. Faults in a loudspeaker will be audible on all programme sources. A fault which is evident only when playing CDs but not, for example, when using a radio tuner is unlikely to originate with the loudspeakers.

Customer Services Department
KEF Audio (UK), Eccleston Road, Tovil,
MAIDSTONE, Kent, ME15 6QP UK

Telephone No.: +44 (0)1622 672261
Fax No.: +44 (0)1622 750653
www.kef.com

Specifications

MODEL 207/2

Design :

Bass reflex four-way floorstanding loudspeaker,
magnetically shielded.

Drive Unit Array :

2 x 250mm (10in.) LF
1 x 250mm (10in.) LMF
1 x 165mm (6.5in.) Uni-Q MF
including a 25mm (1in.) titanium HF

Frequency Response :

(@ 15° horizontally off axis ± 3dB) 40Hz - 60kHz

Crossover Frequencies :

120Hz, 350Hz, 2.3kHz

Amplifier Requirements :

50 - 400W

Sensitivity :

(2.83V / 1m) 91dB

Maximum Output :

117dB

Impedance :

8Ω (3.0Ω min)

Bass Extension :

26Hz (-6dB)

Weight :

66Kg (145lbs)

Dimensions (H x W x D) :

1226 x 400 x 685 mm
48.2 x 15.7 x 27 in.

Finishes :

Piano Black
High Gloss Cherry
High Gloss American Walnut
Satin Sycamore

MODEL 205/2

Design :

Bass reflex three-way floorstanding loudspeaker,
magnetically shielded.

Drive Unit Array :

2 x 200mm (8in.) LF
1 x 165mm (6.5in.) Uni-Q MF
including a 25mm (1in.) titanium HF

Frequency Response :

(@ 15° horizontally off axis ± 3dB) 45Hz - 60kHz

Crossover Frequencies :

400Hz, 2.3kHz

Amplifier Requirements :

50 - 300W

Sensitivity :

(2.83V / 1m) 90dB

Maximum Output :

115dB

Impedance :

8Ω (3.2Ω min)

Bass Extension :

35Hz (-6dB)

Weight :

33Kg (72.6lbs)

Dimensions (H x W x D) :

1105 x 285 x 433 mm
43.5 x 11.2 x 17 in.

Finishes :

Piano Black
High Gloss Cherry
High Gloss American Walnut
Satin Sycamore

MODEL 203/2

Design :

Bass reflex three-way floorstanding loudspeaker,
magnetically shielded.

Drive Unit Array :

2 x 165mm (6.5in.) LF
1 x 165mm (6.5in.) Uni-Q MF
including a 25mm (1in.) titanium HF

Frequency Response :

(@ 15° horizontally off axis ± 3dB) 50Hz - 60kHz

Crossover Frequencies :

300Hz, 2.3kHz

Amplifier Requirements :

50 - 200W

Sensitivity :

(2.83V / 1m) 89dB

Maximum Output :

113dB

Impedance :

8Ω (3.2Ω min)

Bass Extension :

40Hz (-6dB)

Weight :

26.5Kg (58.3lbs)

Dimensions (H x W x D) :

1020 x 248 x 405 mm
40.2 x 9.8 x 15.9 in.

Finishes :

Piano Black
High Gloss Cherry
High Gloss American Walnut
Satin Sycamore

MODEL 201/2

Design :

Bass reflex three-way bookshelf loudspeaker,
magnetically shielded.

Drive Unit Array :

1 x 165mm (6.5in.) LF
1 x 165mm (6.5in.) Uni-Q MF
including a 25mm (1in.) titanium HF

Frequency Response :

(@ 15° horizontally off axis ± 3dB) 55Hz - 60kHz

Crossover Frequencies :

450Hz, 2.5kHz

Amplifier Requirements :

50 - 150W

Sensitivity :

(2.83V / 1m) 86dB

Maximum Output :

110dB

Impedance :

8Ω (4.2Ω min)

Bass Extension :

44Hz (-6dB)

Weight :

12.3Kg (27.1lbs)

Dimensions (H x W x D) :

417 x 248 x 405 mm
16.4 x 9.8 x 15.9 in.

Finishes :

Piano Black
High Gloss Cherry
High Gloss American Walnut
Satin Sycamore

MODEL 202/2c

Design :

Bass reflex three-way centre loudspeaker,
magnetically shielded.

Drive Unit Array :

2 x 165mm (6.5in.) LF
1 x 165mm (6.5in.) Uni-Q MF
including a 25mm (1in.) titanium HF

Frequency Response :

(@ 15° horizontally off axis ± 3dB) 65Hz - 60kHz

Crossover Frequencies :

400Hz, 2.3kHz

Amplifier Requirements :

50 - 200W

Sensitivity :

(2.83V / 1m) 89dB

Maximum Output :

113dB

Impedance :

8Ω (3.2Ω min)

Bass Extension :

50Hz (-6dB)

Weight :

15.6Kg (34.3lbs)

Dimensions (H x W x D) :

200 x 630 x 315 mm
7.9 x 24.8 x 12.4 in.

Finishes :

Piano Black
High Gloss Cherry
High Gloss American Walnut
Satin Sycamore

MODEL 204/2c

Design :

Bass reflex three-way centre loudspeaker,
magnetically shielded.

Drive Unit Array :

4 x 165mm (6.5in.) LF
1 x 165mm (6.5in.) Uni-Q MF
including a 25mm (1in.) titanium HF

Frequency Response :

(@ 15° horizontally off axis ± 3dB) 53Hz - 60kHz

Crossover frequencies :

400Hz, 2.3kHz

Amplifier Requirements :

50 - 300W

Sensitivity :

(2.83V / 1m) 90dB

Maximum Output :

115dB

Impedance :

8Ω (3.2Ω min)

Bass Extension:

40Hz (-6dB)

Weight :

34.6Kg (76lbs)

Dimensions (H x W x D) :

200 x 1100 x 425 mm
7.9 x 43.4 x 16.7 in.

Finishes :

Piano Black
High Gloss Cherry
High Gloss American Walnut
Satin Sycamore

MODEL 206/2ds

Design :

Closed box three-way dipole loudspeaker,
magnetically shielded.

Drive Unit Array :

1 x 200mm (8in.) LF
2 x 165mm (6.5in.) Uni-Q MF
including 2 x 25mm (1in.) titanium HF

Frequency Response :

(@ 15° horizontally off axis ± 3dB) 65Hz - 60kHz

Crossover Frequencies :

250Hz, 2.3kHz

Amplifier Requirements :

50 - 200W

Sensitivity :

(2.83V / 1m) 88dB

Maximum Output :

110dB

Impedance :

8Ω (3.2Ω min)

Bass Extension :

55Hz (-6dB)

Weight :

11.6kg (25.5lbs)

Dimensions (H x W x D) :

324 x 400 x 200 mm
12.7 x 15.7 x 7.9 in.

Finishes :

Piano Black
High Gloss Cherry
High Gloss American Walnut
Satin Sycamore

KEF Heritage

KEF was founded in 1961 by an electrical engineer named Raymond Cooke in a Nissen Hut on the premises of a metalworking operation called Kent Engineering & Foundry (hence KEF), on the banks of the River Medway, near Maidstone in Kent.

From the beginning KEF was destined to become a company with a flair for the unusual and controversial in terms of loudspeaker engineering, design, and use of materials. Within a year, KEF, under Cooke's outstanding vision, was planning loudspeakers with bass units using foil-stiffened, vacuum-formed, expanded polystyrene diaphragms and a Melinex or Mylar tweeter. This idea was manifested in the K1, an immediate success, followed by the bookshelf model, Celeste, a loudspeaker with an even more significant commercial success and one that helped secure the early financial stability of the new company.

Re-establishing a previous relationship with the BBC in 1966, Cooke was interested in adopting another material, Neoprene (an artificial rubber) to help maintain sound quality in the mid-band by using it as the surround to the loudspeaker

diaphragm, while using new materials for the diaphragm itself. Cooke was always looking for new materials and settled on Bextrene as a solution, as its lightweight plastic sheet-like properties were flexible enough for shaping and the material remained stable under varying temperature and moisture conditions and was smooth and consistent over a wide bandwidth. As a result, in 1967, two new drive units, the 5in. B110 and 8in. B200 appeared which, with their countless applications, found use in some 3 million systems from KEF and many other loudspeaker brands throughout the world. A new, smaller tweeter also arrived, the T27, which led to the most famous BBC/KEF collaboration, the LS3/5A, of which some 100,000 units were sold world-wide.

During the 1960's KEF flourished. Loudspeakers such as the Concord, Concerto and Cresta and then, in 1969, the Chorale began to shape the company's growing reputation as 'The Loudspeaker Engineers', a fact justly recognized in 1970 when KEF received the first of two Queen's Awards for Export Achievement.



Photograph: Maryn Goddard. Courtesy Sunday Telegraph Colour Supplement.



The 1970's

By 1973 the company was developing the concept of computer assisted 'Total System' design, at a time when the world's very first 4-bit microprocessor was still in its infancy. KEF engineers, using a given set of parameters, could for the first time actually "see" what the response characteristics of a loudspeaker system would be. KEF was the first loudspeaker company in the world to take the new technology seriously in order to achieve this. Now it was the use of computers and digital test methods which provided the KEF engineers with the relevant crossover and drive unit data at a glance, thus dramatically improving their ability to produce loudspeakers of outstanding accuracy. Amongst other benefits, KEF loudspeakers could now be computer matched as an almost identical pair - to within one-half of a dB.

1973 then saw the introduction of the first KEF Reference Series Model, the 104 which swept reviewers, distributors, retailers and customers off their feet. The archetypal 'domestic monitor' 104 provided the standards of a broadcast monitor loudspeaker in a domestic package, probably for the first time.



The Model 105/3

With the installation of a Hewlett Packard computer at the Maidstone Head Office in 1975, the Corelli, Calinda, and Cantata were all designed under the total system concept and with them came a second Queen's Award for Export in the same year.

1977 saw the most radical KEF design yet in the Model 105 which apart from setting new standards for flat frequency response introduced a design by which the mid and treble were split from the bass box and placed within a contoured moulded enclosure above the bass enclosure. The added ability to angle the separate unique head unit provided the opportunity for the user to tailor the 105 to his or her own environment. The loudspeaker was of such general importance and consumer interest that a leading quality UK Newspaper, The Daily Telegraph, featured the Model 105 on the front cover of its magazine supplement. More Reference Models were to follow. 1978 saw the launch of the 101 and 103 and, in 1979 a further refined 105/2 Model appeared.



'Total System' design testing equipment

The 1980's

Ten years of growth world-wide followed, peaking with a massive onslaught on the lucrative and influential US market in 1985 with the setting up of KEF Electronics of America, seen as the appropriate recognition of this important market-place.

1986 saw more activity amongst the now world famous KEF Reference Series; the 104/2, always regarded as one of the world's truly outstanding loudspeakers since its 1984 launch spawned the 107, in reality an evolution of the 105/2 but with KEF's coupled-cavity bass loading, a system which positions the drivers internal to the enclosure, each separately loaded and firing into a third common chamber which delivers very tight and accurate bass to the listening area via a substantial front-mounted port. This combines the taut sonic character of a sealed box with the higher sensitivity of a reflex design and succeeds in providing a huge boost to bass performance. Also came the 102 and the 103/3, both accepted by recording and broadcast engineers as ideal monitors. KEF's reputation as loudspeaker engineers was set in stone. As well as the coupled-cavity bass loading system, KEF Reference loudspeakers boasted such highly sophisticated features as a conjugate load network technique, which makes even a complicated loudspeaker design simplicity itself from the amplifier's perspective and a heavily damped midrange module which preserves low coloration and fine stereo. A force cancelling rod, fitted between the vertically opposed bass units was an added introduction, eliminating the possibility for coloration caused by woofer vibrations exciting the enclosure panels.

Amidst all this excitement, 1988 also brought in the birth of the KEF Custom Installation loudspeakers, a move made in response to new world market demands. The same exacting engineering standards were naturally applied to the range and the CR200F and its sub-bass partner, the CR250SW set new standards from in-wall/ceiling units.

Then, again in 1988, came Uni-Q. A design process, painstakingly evolved by KEF over several years, by which a single point source at last became a reality. The HF units made use of a rare-earth magnet material, Neodymium/Iron/Boron which was developed for the NASA Space Programme. 10 times more powerful than a conventional loudspeaker magnet, this material allowed KEF engineers to make a tweeter small enough to fit within the bass unit coil former at the precise acoustic centre of the cone. KEF's Uni-Q technology delivered well-defined stereo imaging over a much wider listening area without the need for the time honoured sacred "hot-spot" in the listening room. The 105/3 was a massive success, bringing together, not just Uni-Q (now in its second generation form), but all of KEF's magnificent technology - coupled-cavity bass loading, conjugate load matching, force cancelling rod, computer matched crossovers and drive units, even hand pair-matched veneer finishes - in fact almost everything by which KEF had made its name as the world's foremost loudspeaker company - in to one product. It was voted Best Imported Speaker by the Japanese Press in 1992.

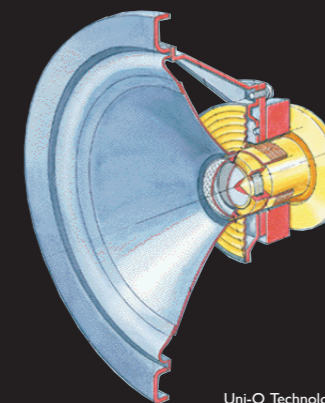

Uni-Q Technology



The 1990's

Under new ownership in 1992 KEF Audio found itself equipped with new ideas, new personalities and new products. But the same philosophies of solid engineering and innovation to provide the finest quality product available at its particular price-point remained firmly at the bed-rock.

In 1994 and 1995 the company brought out the versatile and appealing Q Series, offering all the benefits of a third generation Uni-Q driver but in a shielded format for AV use, together with the multi-award winning Model 100 Centre Loudspeaker, the Model 90, the new Model 200C and the Reference Series Models One, Two, Three and Four. KEF also introduced the new entry level Home Theatre System for true audiophile home theatre sound at a price to fit most pockets. At the end of 1994 the company had quietly launched three loudspeakers that were to become one of the most spectacular success stories in recent KEF history. These were simply called Coda; affordable loudspeakers that took the world's Press by storm, the baby Coda 7 clinching the coveted UK Magazine What Hi-fi?'s "Best Buy" Loudspeaker of the of the Year Award for 1995.

KEF's founding father, Raymond Cooke O.B.E., sadly died during 1996, but with the knowledge that all of his original and noble principles remained intact, and would always do so.

Recognition that year for the Reference Series Model Four had reached a peak with world-wide acclaim. Reviews by internationally famed and respected writers were quick to praise the merits of the company's new flagship model with its fourth generation Uni-Q driver and to point out the sheer engineering excellence of the company - an unswerving KEF attribute for over 30 years. Comments such as "the best I've had in my listening room." from the US magazine Stereophile and "KEF's best yet" from UK magazine Hi-fi News were just two of the many plaudits showered on the Model Four.

The home theatre series boomed and the company introduced the Model 20B, a baby brother for the Model 30B active subwoofer. The Coda Series, particularly the Coda 7, continually outsold competing brands throughout the world. 1996 also saw the launch of the new Q Series and the new Monitor Series, superbly crafted loudspeakers to meet the challenges of the next century. Both ranges epitomise KEF's total commitment to engineering qualities beyond all. As the 90's drew to a close, KEF introduced the Reference Series Model 109 - The Maidstone. Over thirty five years of technical excellence, innovation in design and award winning engineering combined in one stunning loudspeaker. (Pictured Opposite).



KEF's acclaimed Reference Series





The 2000's

The millennium ushered in a new era of groundbreaking audio innovation.

Among the most important was the launch of a new Reference Series - the forerunner of today's design - in 2002. This redefined the benchmark for high-end loudspeakers by incorporating signature KEF technologies such as Uni-Q and the 'pod' concept.

The decade had begun with the introduction of a product destined to become a design icon in its own right: the KHT (KEF Home Theatre) 2005 system. With satellite loudspeakers nicknamed 'KEF eggs' because of their distinctive elliptical shape, KHT2005 represented a real breakthrough not only in terms of the build quality and sonic performance that it offered but at a price that many found "very reasonable indeed".

With the rising demand for home entertainment systems, the KHT series steadily grew to encompass both smaller and larger variants. The concept proved a worldwide success, with all models earning enthusiastic reviews and a plethora of awards, and the expanded range remains popular today.

Another patented KEF innovation of the 21st century was Acoustic Compliance Enhancement, or ACE. This technology was developed in the constant quest to resolve a fundamental dilemma of loudspeaker design: how to optimise the trade-off between the large cabinet size required for maximum bass extension and popular demand for smaller, less obtrusive loudspeakers in modern living rooms.

ACE largely succeeded in overcoming these conflicting constraints by adding granules of activated carbon inside the driver enclosures. By a molecular process known as adsorption, the presence of the granules makes each enclosure sound twice as big as it actually is.

Yet more KEF innovations soon followed. The KIT (KEF Instant Theatre) concept, for example, proved an immediate hit - an integrated multimedia home entertainment system for consumers who want a complete, user-friendly package that offers quality sound without being complicated to set up.

One of the most revolutionary aspects of the design is that it delivers the apparently impossible: a three-dimensional surround sound image from only two loudspeakers. This was achieved by adding two flat panel drivers behind each front loudspeaker driver to act as rear loudspeakers by radiating the sound behind the listening area. This radical concept has since been applied to other KEF home entertainment products.

The launch of the new Q Series in 2005 further strengthened KEF's position as an acknowledged market leader in mid-priced audiophile quality loudspeakers. With its high performance Uni-Q driver array, distinctive curved cabinets and outstanding build quality and finish, the new range was soon being referred to as "the baby Reference".

Since then though, the Reference has evolved further still. True to our vision and roots as high-end audio designers, KEF engineers have been concentrating on raising the bar in terms of ultimate sonic performance. And the result, it has to be said, is outstanding. When the latest KEF Reference technologies were showcased at the prestigious High End 2006 audio show in Munich, prototypes for our new 'Austin' (pictured opposite) concept loudspeakers were voted by some the best sound of the show in independent comparative tests.

Now as in '61, it's all about greatness by design.



www.kef.com

GP Acoustics (UK) Ltd., Eccleston Road, Tovil, Maidstone, Kent, ME15 6QP U.K. Telephone: + 44 (0)1622 672261 Fax: + 44 (0)1622 750653

GP Acoustics (US), Inc., 10 Timber Lane, Marlboro, New Jersey 07746 U.S.A. Telephone: +(1) 732 683 2356 Fax: +(1) 732 683 2358

GP Acoustics GmbH, Heinrichstraße 51, D-44536 Lünen, Deutschland. Telephone: +49 (0) 231 9860-320. Fax: +49 (0) 231 9860-330

GP Acoustics (France) SAS, 39 Rue des Granges Galand - BP414, 37554 Saint Avertin CEDEX, France. Tel : +33(0)2 47 80 49 01 Fax : +33(0)2 47 27 89 64

Free Manuals Download Website

<http://myh66.com>

<http://usermanuals.us>

<http://www.somanuals.com>

<http://www.4manuals.cc>

<http://www.manual-lib.com>

<http://www.404manual.com>

<http://www.luxmanual.com>

<http://aubethermostatmanual.com>

Golf course search by state

<http://golfingnear.com>

Email search by domain

<http://emailbydomain.com>

Auto manuals search

<http://auto.somanuals.com>

TV manuals search

<http://tv.somanuals.com>