

KHT
5005
hear it and be there



- | | | | |
|-----------|-------------------------|-----------|------------------------|
| GB | Installation Manual | ES | Manual de instalación |
| F | Manuel d'installation | P | Manual de instalação |
| D | Installationshandbuch | NL | Installatie |
| I | Manuale d'installazione | DK | Installationsanvisning |

SAFETY INFORMATION

WARNING

TO REDUCE THE RISK OF FIRE OR ELECTRICAL SHOCK, DO NOT EXPOSE THIS APPLIANCE TO RAIN OR MOISTURE



- A combined mains power input lead and country specific mains plug is provided.
- Check before connecting to your local mains supply that the local supply voltage is the same as that marked on the rear panel. If it is not, check with your supplier before proceeding.

Explanation of Graphical Symbols



The lightning flash with arrowhead symbol, within an equilateral triangle, is intended to alert the user to the presence of uninsulated “dangerous voltage” within the products enclosure that may be of a sufficient magnitude to constitute a risk of electrical shock to persons.



The exclamation mark within an equilateral triangle is intended to alert the user to the presence of important operating and maintenance (servicing) instructions in the literature accompanying the appliance.

WARNING:

Due to the mains switch being located on the rear panel, the apparatus must be located in an open area without anything obstructing access to the mains switch.

FOR UK:

The mains lead is terminated with a moulded three pin plug.

Should the plug on the flexible cord not be of the type for your socket outlets do not use an adaptor but remove the plug from the cord and discard. Carefully prepare the end of the supply cord and fit a suitable plug.

The fuse must be replaced with one of the same rating.

IMPORTANT

The wires in this mains lead are coloured in accordance with the following code:

Blue:	Neutral
Brown:	Live
Yellow & Green:	Earth

As the colours of the wires in the mains lead of this appliance may not correspond with the coloured markings identifying the terminals in your plug, proceed as follows:

The wire which is coloured Blue must be connected to the terminal which is marked by the letter N or coloured Black.

The wire which is coloured Brown must be connected to the terminal which is marked with the letter L or coloured Red.

FOR EUROPE:

A mains lead compatible with national earthing standards and complying with the local safety requirement is supplied.

IMPORTANT SAFETY INSTRUCTIONS

Please take heed of the following before using the KHT Subwoofer. Note also that the word “appliance” shall refer to the KHT Subwoofer, or any part of it.

1. **Read Instructions** – All the Safety and Operating Instructions should be read before the appliance is operated.
2. **Retain Instructions** – The Safety and Operating Instructions should be retained for future reference.
3. **Heed Warnings** – All warnings on the appliance and in the Operating Instructions should be adhered to.
4. **Follow Instructions** – All Operating and Use Instructions should be followed.
5. **Water and Moisture** – The appliance should not be used in or near water - for example, near a bathtub, washbowl, kitchen sink, laundry tub, in a wet basement, or near a swimming pool, and the like.
6. **Ventilation** – The appliance should be situated so that its location or position does not interfere with its proper ventilation. For example, the appliance should not be situated on a bed, sofa, or similar surface that may block any ventilation openings; or placed in a built-in installation, such as a bookcase or cabinet that may impede the flow of air through the ventilation openings.
7. **Heat** – The appliance should be situated away from heat sources such as radiators, heat registers, stoves or other appliances (including amplifiers) that produce heat.
8. **Power Sources** – The appliance should be connected to a power supply only of the type described in the operating instructions or as marked on the appliance.
9. **Grounding or Polarisation** – The precautions should be taken so that the grounding or polarisation means of an appliance are not defeated.
10. **Power-cord Protection** – Power supply cords should be routed so that they are not likely to be walked on or pinched by items placed upon or against them, paying particular attention to cords at plugs, convenience receptacles and the point where they exit from the appliance.
11. **Cleaning** – The appliance should be cleaned only as recommended by the manufacturer.
12. **Non-use Periods** – The power cord of the appliance should be unplugged from the outlet or turn off the “ON/OFF” switch when left unused for a long period of time.
13. **Object and Liquid Entry** – Care should be taken so that objects do not fall and liquids are not spilled into the enclosure through openings.
14. **Damage Requiring Service** – The appliance should be serviced by qualified service personnel when:
 - a) The power supply cord or the plug has been damaged; *or*
 - b) Objects have fallen or liquid has been spilled into the appliance; *or*
 - c) The appliance has been exposed to rain; *or*
 - d) The appliance does not appear to operate normally or exhibits a marked change in performance; *or*
 - e) The appliance has been dropped or the enclosure damaged.
15. **Servicing** – The user shall not attempt to service the appliance beyond that described in the Operating Instructions. All other servicing should be referred to qualified service personnel.

1. INDEX

(F) Table des matières (D) Übersicht (I) Indice (ES) Índice (P) Índice (NL) Index (DK) Indholdsfortegnelse

1	GB	Index	2
	F	Table des matières	2
	D	Übersicht	2
	I	Indice	2
	ES	Índice	2
	P	Índice	2
	NL	Index	2
	DK	Indholdsfortegnelse	2
2	GB	Introduction / Using the manual	3
	F	Introduction / Utilisation du manuel	3
	D	Einleitung / Verwendung der Anleitung	3
	I	Introduzione / Uso del manuale	3
	ES	Introducción / Uso del manual	3
	P	Introdução / Utilização do manual	3
	NL	Inleiding / Gebruik van de handleiding	3
	DK	Introduktion / Brug af manualen	3
3	GB	Important Points	4
	F	Points importants	4
	D	Wichtige Punkte	4
	I	Punti importanti	4
	ES	Puntos importantes	4
	P	Pontos importantes	4
	NL	Belangrijke aandachtspunten	4
	DK	Vigtige punkter	4
4	GB	Unpacking	5
	F	Déballage	5
	D	Auspacken	5
	I	Apertura della confezione	5
	ES	Desembalaje	5
	P	Desembalagem	5
	NL	Het toestel uitpakken	5
	DK	Udpakning	5
5	GB	Controls and Sockets	6
	F	Commandes et prises	6
	D	Bedienungselemente und Anschlüsse	6
	I	Comandi e prese	6
	ES	Controles y conexiones	6
	P	Comandos e fichas	6
	NL	Regelaars en aansluitingen	6
	DK	Betjeningsknapper og stik	6
6	GB	English Instructions	7
	F	Instructions en français	8
	D	Deutsche Anleitung	9
	I	Istruzioni in italiano	10
	ES	Instrucciones en español	11
	P	Instruções em português	12
	NL	Nederlandse Handleiding	13
	DK	Danske instruktioner	14
7	GB	Wall Mounting	15
	F	Installation Murale	15
	D	Schablone für Wandmontage	15
	I	Montaggio a Parete	15
	ES	Montaje en Pared	15
	P	Montagem na parede	15
	NL	Wandmontage	15
	DK	Væg Montering	15
8	GB	Positioning	17
	F	Positionnement	17
	D	Aufstellung	17
	I	Posizionamento	17
	ES	Posicionamiento	17
	P	Posicionamento	17
	NL	Plaats en aansluiting van het netsnoer	17
	DK	Placering	17
9	GB	Connections	18
	F	Connexions	18
	D	Anschlüsse	18
	I	Collegamenti	18
	ES	Conexiones	18
	P	Ligações	18
	NL	Aansluitingen	18
	DK	Forbindelser	18
10	GB	Adjusting the controls	20
	F	Réglage des commandes	20
	D	Einstellen der Bedienungselemente	20
	I	Regolazione dei comandi	20
	ES	Ajuste de los controles	20
	P	Ajuste dos comandos	20
	NL	Bediening van de regelaars	20
	DK	Justering af betjeningsknapperne	20
11	GB	Specifications	21
	F	Spécifications	21
	D	Technische Merkmale	21
	I	Specifiche	21
	ES	Especificaciones	21
	P	Especificações	21
	NL	Technische gegevens	21
	DK	Specifikationer	21

2. INTRODUCTION

(F) Introduction (D) Einleitung (I) Introduzione (ES) Introducción (P) Introdução (NL) Inleiding (DK) Introduktion

- GB** Thank you for purchasing the KHT5005. We are confident that it will provide reliable, high performance sound for many years to come. Please read this manual fully before you attempt any connections to the KHT5005.
- F** Nous vous remercions de la confiance que vous témoignez à KEF, Le KHT 5005 a été élaboré avec tout le soin nécessaire et vous procurera de longues années de plaisir sonore et musical. Veuillez lire attentivement le mode d'emploi avant de connecter le KHT 5005 afin de l'utiliser au maximum de ses possibilités et d'éviter tout problème.
- D** Danke für den Erwerb der KHT5005. Wir sind davon überzeugt, dass die KHT5005 Ihnen Zuverlässigkeit und hohe Leistungsqualität im Musikbereich für viele Jahre verspricht. Bitte lesen Sie die Betriebsanleitung komplett durch bevor Sie die KHT5005 in Betrieb nehmen.
- I** Grazie per aver acquistato il sistema KHT5005. Siamo certi che vi soddisferà pienamente per molti anni a venire. Leggete attentamente questo manuale prima di eseguire i collegamenti.
- ES** Gracias por adquirir el modelo KHT5005. Un producto de calidad excepcional capaz de garantizar un sonido de alta calidad por muchos años. Por favor lea atentamente este manual antes de seguir adelante con las conexiones del KHT5005.
- P** Muito obrigada por ter adquirido o KHT5005. Estamos confiantes que ele lhe irá oferecer, por muitos anos, um som de elevada performance, de confiança e de excelente qualidade. Leia por favor, com atenção, este manual antes de efectuar quaisquer ligações ao KHT5005.
- NL** Hartelijk dank voor aanschaf van de KHT5005. Wij vertrouwen erop dat deze combinatie u jarenlang hoogwaardig luisterplezier zal blijven bieden. Lees alstublieft eerst deze handleiding alvorens de KHT5005 aan te sluiten.
- DK** Tak for dit køb af KHT5005. Vi er overbeviste om, at den vil give dig en højkvalitativ og musikalsk ydelse i mange år frem i tiden. Læs denne manual grundigt før du tilslutter og anvender din KHT5005, så får du optimalt udbytte af din investering.

USING THE MANUAL

(F) Utilisation du manuel (D) Verwendung der Anleitung (I) Uso del manuale (ES) Uso del manual (P) Utilização do manual (NL) Gebruik van de handleiding (DK) Brug af manualen

- GB** The following icons are used throughout this manual to help you safely install your new speakers. **Please follow them carefully.**
- F** Les icônes reprises ci-après sont utilisées dans tout le manuel de manière à vous aider à installer vos nouveaux haut-parleurs en toute sécurité. **Veillez suivre scrupuleusement leur signification.**
- D** Die folgenden Symbole finden Sie in der gesamten Anleitung. Sie erleichtern eine sichere installation Ihrer neuen Lautsprecher. **Bitte achten Sie sorgfältig auf die Symbole.**
- I** Le seguenti icone usate nel manuale aiutano ad installare correttamente i diffusori. **Si raccomanda di seguirle con attenzione.**
- ES** Se utilizan los iconos siguientes en este manual para ayudarle a instalar con seguridad sus nuevos altavoces. **Sígalas cuidadosamente.**
- P** Os seguintes ícones são utilizados no manual afim de o ajudarem a instalar com segurança as suas novas colunas. **Siga-os cuidadosamente.**
- NL** De hierna volgende pictogrammen worden in de hele handleiding gebruikt om u te helpen bij het veilig aansluiten en gebruiken van uw nieuwe luidsprekers. **Volg de instructies steeds nauwgezet op.**
- DK** Følgende symboler benyttes i denne manual, for at hjælpe dig med sikker installation af dine højttalere. **Følg dem nøje.**



(GB) Correct
(F) Correct
(D) Richtig
(I) Corretto
(ES) Correcto
(P) Correcto
(NL) Juist
(DK) Korrekt



(GB) Wrong
(F) Incorrect
(D) Falsch
(I) Errato
(ES) Incorrecto
(P) Errado
(NL) Fout
(DK) Forkert



(GB) Option
(F) Option
(D) Option
(I) Opzione
(ES) Opción
(P) Opcional
(NL) Optie
(DK) Tilbehør



(GB) Adjustment
(F) Réglage
(D) Einstellung
(I) Regolazione
(ES) Ajuste
(P) Ajuste
(NL) Instelling
(DK) Justering



(GB) Caution/Warning
(F) Attention/Avertissement
(D) Achtung / Warnung
(I) Attenzione/Avvertenza
(ES) Precaución/Atención
(P) Atenção/ Aviso
(NL) Opgelet/Waarschuwing
(DK) Forsigtigt / Advarsel



(GB) Electrical Warning
(F) Danger électrique
(D) Warnung: Gefährliche Spannungen
(I) Rischî elettrici
(ES) Advertencia eléctrica
(P) Aviso sobre a parte eléctrica
(NL) Opgelet! Elektriciteit!
(DK) Elektrisk advarsel



(GB) Positive/RED
(F) Positif / ROUGE
(D) Positiv / ROT
(I) Positivo / ROSSO
(ES) Positivo / ROJO
(P) Positivo/Vermelho
(NL) Positief / ROOD
(DK) Positiv / RØD



(GB) Negative/BLACK
(F) Négatif / NOIR
(D) Negativ / SCHWARZ
(I) Negativo / NERO
(ES) Negativo / NEGRO
(P) Negativo/ Preto
(NL) Negatief / ZWART
(DK) Negativ / SORT



(GB) Switch off appliance
(F) Couper l'appareil
(D) Gerät abschalten
(I) Disattivazione dell'ap parecchio
(ES) Interruptor del aparato
(P) Interruptor para desligar
(NL) Het toestel uitschakelen
(DK) Afbryd apparatet



(GB) Inspect
(F) 'A inspecter'
(D) Kontrollieren
(I) Controllare
(ES) Inspección
(P) Inspeccione
(NL) Controleer
(DK) Undersøg



(GB) Read
(F) 'A lire'
(D) Lesen
(I) Leggere
(ES) Lea
(P) Leia
(NL) Lees
(DK) Gennemlæs



(GB) Sound changes
(F) Modifications du son
(D) Klang verändert sich
(I) Variazioni del suono
(ES) El sonido cambia
(P) Alterações de som
(NL) Veranderingen in de weergave
(DK) Ændring af lyden

3. IMPORTANT POINTS

(F) Points importants (D) Wichtige Punkte (I) Punti importanti (ES) Puntos importantes (P) Pontos importantes (NL) Belangrijke aandachtspunten (DK) Vigtige punkter

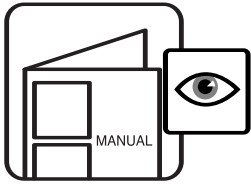

- (GB) Follow this manual carefully for best results from speakers.
- (F) Afin de tirer les meilleurs résultats des haut-parleurs, veuillez suivre scrupuleusement les instructions reprises dans le présent manuel.
- (D) Für optimale Ergebnisse mit Ihrem Lautsprecher befolgen Sie diese Anleitung
- (I) Per ottenere le migliori prestazioni dai diffusori seguire le istruzioni contenute nel presente manuale
- (ES) Siga las instrucciones de este manual para obtener los mejores resultados de los altavoces
- (P) Siga este manual atentamente para obter o melhor resultado das colunas
- (NL) Volg terwille van een optimaal resultaat de instructies nauwkeurig op.
- (DK) Følg denne manual omhyggeligt for at opnå det bedste resultat fra højttalerne

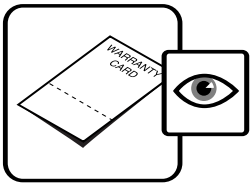

- (GB) Read and return warranty card.
- (F) Veuillez lire et renvoyer la carte de garantie.
- (D) Lesen Sie die Garantiekarte und senden Sie sie ausgefüllt zurück.
- (I) Si prega di restituire la scheda di garanzia, previa attenta lettura
- (ES) Lea y envíenos la tarjeta de garantía
- (P) Leia e devolva o cartão de garantia
- (NL) U kunt na lezing en invulling de garantietaal aan de importeur sturen.
- (DK) Gennemlæs og send garantibeviset tilbage

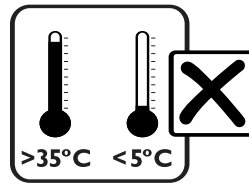

- (GB) Avoid temperature extremes.
- (F) Eviter les températures extrêmes.
- (D) Extreme Temperaturen vermeiden.
- (I) Evitare temperature troppo alte o troppo basse.
- (ES) Evite temperaturas extremas
- (P) Evite temperaturas extremas
- (NL) Vermijd extreme temperaturen.
- (DK) Undgå ekstreme temperaturer

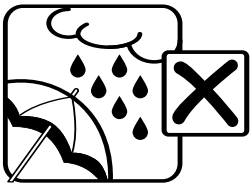

- (GB) Avoid damp.
- (F) Eviter l'humidité.
- (D) Feuchtigkeit vermeiden.
- (I) Evitare l'umidità
- (ES) Evite la humedad
- (P) Evite a humidade
- (NL) Vermijd vocht
- (DK) Undgå fugt

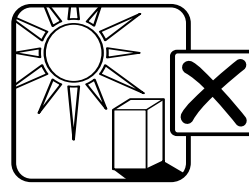

- (GB) Avoid direct sunlight.
- (F) Eviter l'exposition directe aux rayons du soleil.
- (D) Direktes Sonnenlicht vermeiden.
- (I) Evitare l'esposizione diretta ai raggi del sole
- (ES) Evite la luz directa del sol
- (P) Evite a exposição directa à luz do sol
- (NL) Vermijd rechtstreeks zonlicht
- (DK) Undgå direkte sollys

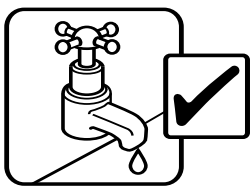

- (GB) Clean with a damp lint free cloth.
- (F) Nettoyer à l'aide d'un chiffon humide, non pelucheux.
- (D) Mit einem angefeuchteten, nicht fuselnden Tuch abwischen.
- (I) Pulire con un panno umido non sfilacciato
- (ES) Limpie con un paño húmedo
- (P) Limpe com um pano húmido sem pêlos
- (NL) Reinigen met een vochtige niet pluizende doek
- (DK) Rengør med en fugtig klud, der ikke frugger



- (GB) Do not use spirit based cleaners.
- (F) Ne pas utiliser d'agents nettoyants à base d'alcool.
- (D) Keine alkoholhaltigen Reinigungsmittel verwenden.
- (I) Non utilizzare prodotti a base di alcol
- (ES) No use limpiadores con base de alcohol
- (P) Não utilize produtos de limpeza à base de álcool
- (NL) Gebruik geen reinigingsprodukten op basis van alcohol
- (DK) Brug ikke rengøringsmidler med alkohol



- (GB) SAFETY NOTICE! trailing cables are dangerous, secure all cables.
- (F) NOTE DE SECURITE ! Les câbles de haut-parleurs traînant sur le sol peuvent être source de danger. Fixer tous les câbles.
- (D) SICHERHEITSHINWEIS ! Herumliegende Lautsprecherkabel sind eine Gefahrenquelle. Bitte alle Lautsprecherkabel sorgfältig verlegen.
- (I) NOTA PER LA SICUREZZA: i cavi di uscita dei diffusori possono essere pericolosi se non sistemati in un posto sicuro.
- (ES) ¡ATENCIÓN! los cables de conexión sueltos de los altavoces son peligrosos. Fíjelos
- (P) Precauções de segurança! Os cabos das colunas espalhados são perigosos, fixe todos os cabos
- (NL) VOOR UW VEILIGHEID! Loshangende luidsprekerkabels zijn gevaarlijk! De kabels steeds op een veilige plaats leggen.
- (DK) BEMÆRK! skarpe knæk og slid på højttalerledningerne er farlig, de skal fastgøres.

4. UNPACKING

(F) Déballage (D) Auspacken (I) Apertura della confezione (ES) Desembalaje (P) Desembalagem (NL) Het toestel uitpakken (DK) Udpakning

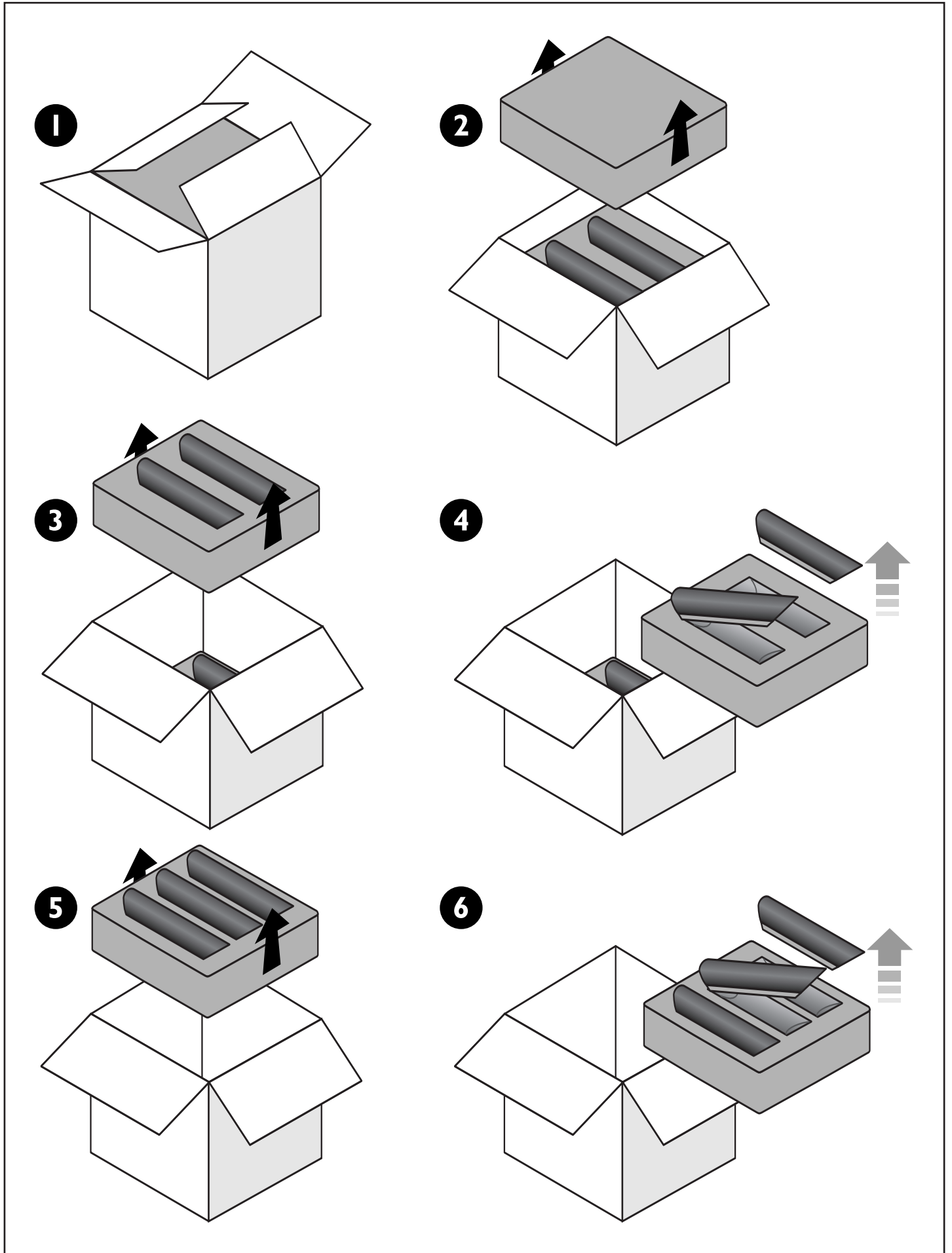

5. CONTROLS AND SOCKETS

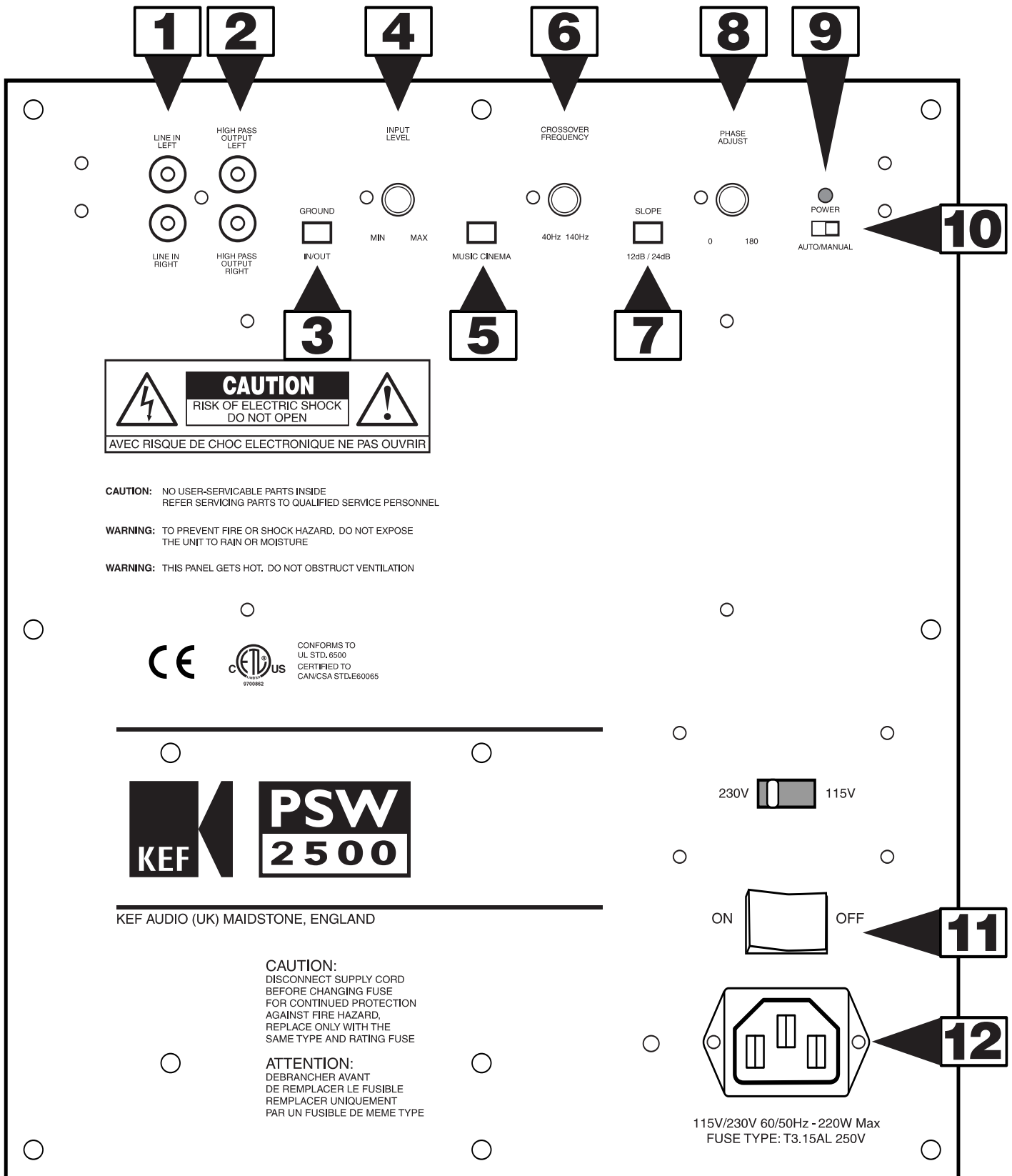

(F) Commandes et prises (D) Bedienungselemente und Anschlüsse (I) Comandi e prese (ES) Controles y conexiones (P) Comandos e fichas
(NL) Regelaars en aansluitingen (DK) Betjeningsknapper og stik



6. ENGLISH INSTRUCTIONS

5 Controls and sockets

KHT Subwoofer Rear Panel

1. Line in input sockets
2. High pass output sockets
3. Ground In / Out
4. Level control
5. Music / Cinema
6. Crossover Frequency control
7. Slope
8. Phase control
9. Mains indicator light Power ON 
Power OFF 
10. Auto/manual switch
11. 'ON/OFF' switch (Vacation switch)
12. AC power input (230V Euro SP 3333 AA)
(230V UK SP 3333 AC)
(115V US SP 3333 AB)

8 Positioning

As the sub-bass (low frequency) sound produced by the subwoofer is non-directional it can be positioned almost anywhere in the room, although it should not be placed too close to the listener. If possible try the subwoofer in different positions to find the best place for a boom-free sound.

9 Connections

Front speakers full range - speakers capable of producing full frequency range.

- A. **Line Level** - connected to amplifier processor loop.
- B. **Line level inputs** - connected to subwoofer output on amplifier by single (C1) or 'Y' (C2) cable.

10 Adjusting the controls

A. Frequency Control

The frequency control changes the upper cut-off frequency of the subwoofer. Its effective range is from 40Hz to 140Hz at a rate of 12dB/24dB per octave. The frequency control should be adjusted to achieve the smoothest integration between the main/satellite speakers and the subwoofer.

Clockwise rotation will increase the cut-off frequency and anti-clockwise rotation will decrease the cut-off frequency.

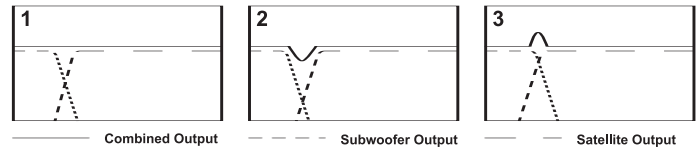

1. Ideal Crossover - Flat Response.
2. Crossover point set too low - Causes Dip in combined response.
3. Crossover Point set too high - Causes hump in combined response.

B. Phase Control

The phase control will normally be set at 0° but more output level can sometimes be achieved in the 180° position, particularly when the subwoofer is far away from the satellite speakers.

C. Volume Control

The volume control adjusts the output level of the subwoofer in relation to the satellite or AV speaker output level. Clockwise rotation to increase the output level or anti-clockwise to decrease the output level.

D. Auto/Manual Switch

It enables / disables your subwoofer in standby (mute). Setting this switch to Auto position, the subwoofer will go to standby automatically if idle for 45 minutes. It resumes working immediately after an input signal is received. If Manual is set, the unit will not go to standby even when there is no signal input.

E. Ground In/Out

Enhances compatibility. Used to break possible earth loops which cause audible hum.

F. Music/Cinema

This switch selects one of two characteristics: Music is selected to give deep, clean bass; Cinema is selected to give cinematic impact.

G. Slope

Used to adjust transition between speakers and subwoofer.

Fault Finding



FAULT	REMEDY
Mains indicator light does not come on.	<p>Check that the subwoofer is plugged into the mains supply and that any switches are on.</p> <p>Check any fuses (including the plug) or circuit breakers on the mains supply which may effect the power to the subwoofer.</p> <p>Contact your dealer for further advice.</p>
If the mains indicator light still does not come on.	Ensure that all equipment is switched on.
If the mains indicator light is on but no sound comes from the subwoofer.	<p>Check and adjust the level control.</p> <p> Check that the output sockets on the source equipment are correctly switched and adjusted to provide sufficient level to drive the subwoofer.</p> <p>Check that all connections between the subwoofer and the source equipment are correct and adjust as necessary.</p>
If there is still no sound.	Contact your dealer for further advice.

6. INSTRUCTIONS EN FRANÇAIS

5 Commandes et prises

Panneau arrière du modèle KHT Subwoofer.

1. Prises d'entrée auxiliaire.
2. Prises de sortie passe-hautes.
3. Mise à la terre Oui / Non
4. Commande de niveau.
5. Musique / Cinéma
6. Commande de la fréquence de coupure.
7. Courbe de basse
8. Contrôle de phase.
9. Témoin de mise sous tension

MARCHE 
 ARRET 
10. Commutateur Automatique/Manuel.
11. Commutateur 'MARCHE/ARRET' (ON/OFF). (Interrupteur Vacances)
12. Entrée d'alimentation en c.a. (230V Euro SP 3333 AA)
(230V UK SP 3333 AC)
(115V US SP 3333 AB)

8 Positionnement/Branchement sur secteur

Dans la mesure où le son infra-grave (basse fréquence) produit par le subwoofer est non-directionnel, ce dernier peut être placé en n'importe quel endroit de la pièce. On veillera toutefois à ne pas le positionner trop près de l'auditeur. Essayez, si possible, de placer successivement le subwoofer en différents endroits de manière à localiser le meilleur endroit pour un rendu du son sans grondement.

Un fil d'alimentation satisfaisant aux normes nationales de mise à la terre et répondant aux exigences locales en matière de sécurité est fourni avec le subwoofer.

9 Connexions

Et sans résonances - Haut-parleurs avant capables de reproduire la gamme complète des fréquences.

- A. Niveau de ligne** - connecté à la boucle de processeur d'amplificateur.
- B. Entrées niveau de ligne** - connectées à la sortie subwoofer sur l'amplificateur au moyen d'un câble simple ou 'Y'.

10 Réglage des commandes

A. Commande de la fréquence de coupure.

Cette commande modifie la fréquence de coupure supérieure du subwoofer. Sa plage de réglage efficace s'échelonne de 40Hz à 140Hz à un taux de 12 dB / 24 dB par octave. La commande de fréquence doit être réglée de manière à obtenir la parfaite intégration entre les haut-parleurs principaux/satellites et le subwoofer.

Une rotation dans le sens horlogique relèvera la fréquence de coupure et une rotation dans le sens anti-horlogique abaissera la fréquence de coupure.

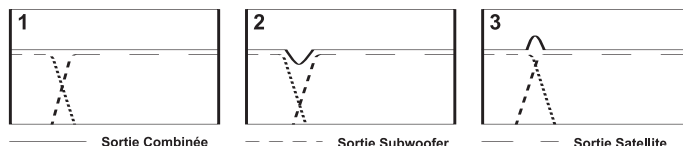

1. Croisement idéal - Réponse plate.
2. Point de croisement réglé trop bas - provoque un creux en réponse combinée.
3. Point de croisement réglé trop haut - provoque une boss en réponse combinée.

B. Contrôle de phase

Le contrôle de phase sera normalement positionné sur 0°. Un niveau plus élevé de sortie peut toutefois être obtenu en position 180°, et ce plus particulièrement lorsque le subwoofer est éloigné des haut-parleurs satellites.

C. Commande du niveau

La commande de niveau règle le niveau de sortie du subwoofer en fonction du niveau de sortie du haut-parleur satellite ou AV. Une rotation dans le sens horlogique augmentera le niveau de sortie et une rotation dans le sens anti-horlogique abaissera le niveau de sortie.

D. Commutateur Automatique/Manuel

Ce commutateur permet d'activer/de désactiver la fonction sourdine de votre subwoofer. En position Automatique, le subwoofer mettra les entrées en sourdine automatiquement s'il est laissé inoccupé pendant 45 minutes. Il se remet instantanément au travail lorsqu'un signal est donné. Si le commutateur est en position Manuel, l'unité ne sera jamais mise en sourdine, même sans signal d'entrée.

E. Mise à la terre oui/non

Améliore la compatibilité avec certains équipements. Utilisé pour éviter les boucles de masse qui pourraient causer un ronflement audible.

F. Musique/Cinéma

Adaptation des performances en fonction de l'utilisation. Musique: basses très propres et profondes. Cinéma: basses donnant plus d'impact.

G. Pente du filtre

Permet une meilleure transition entre le caisson de graves et les enceintes.



Depannage

PROBLEME	REMEDE
Le témoin indicateur de mise sous tension ne s'allume pas.	Vérifier que la fiche du subwoofer est bien branchée sur le secteur et que les commutateurs sont positionnés sur 'ON'. Vérifier tous les fusibles (ainsi que la fiche) circuit d'alimentation du subwoofer. Pour de plus amples conseils, adressez-vous à votre revendeur.
Le témoin indicateur de mise sous tension ne s'allume toujours pas.	Vérifier que toute l'installation est branchée.
Le témoin indicateur de mise sous tension est allumé mais aucun son ne provient du subwoofer.	Vérifier et régler le commande de niveau.  Vérifier que les prises de sortie de l'équipement source sont correctement commutées et procéder à un réglage de manière à obtenir un niveau suffisant pour le subwoofer. Vérifier que toutes les connexions entre le subwoofer et l'équipement source sont correctes et procéder, si nécessaire, à la correction.
Le subwoofer n'émet toujours aucun son.	Pour de plus amples conseils, adressez-vous à votre revendeur.

6. DEUTSCHE ANLEITUNG

5 Bedienungselemente und Anschlüsse

Modell KHT Subwoofer Rückseite

1. Line in-Eingangsbuchsen
2. Hochpass-Ausgangsbuchsen
3. Erdung Ein / Aus
4. PegelEinstellung
5. Musik / Kino
6. Frequenzeinstellung
7. Bassfrequenzkurve
8. Phasensteuerung
9. Betriebsanzeige Betrieb  Gerät ausgeschaltet 
10. Auto/Manual-Schalter
11. Netzschalter (EIN/AUS) (Urlaubsschalter)
12. Netzstromeingang (230V Euro SP 3333 AA)
(230V UK SP 3333 AC)
(115V US SP 3333 AB)

8 Aufstellung/Netzkabelanschluß

Da der vom Subwoofer produzierte Tiefbaß ungerichtet ist, kann das Gerät praktisch fast an jedem Ort im Raum aufgestellt werden. Eine Aufstellung in direkter Nähe des Zu-hörers ist allerdings nicht empfehlenswert. Nach Möglichkeit sollten Sie den Subwoofer probeweise an verschiedenen Orten aufstellen um die beste Position zu ermitteln.

Ein Netzkabel, das den gültigen landesspezifischen Sicherheitsbestimmungen entspricht, ist im Lieferumfang enthalten.

9 Anschlüsse

Vollbereichs-Frontlautsprecher - Lautsprecher für die Wiedergabe des gesamten Frequenzbereichs.

- A. Niederpegel:** Anschluß erfolgt an PRE OUT/MAIN IN- oder PROCESSOR LOOP- Anschlußbuchsen des Verstärkers.
- B. Niederpegelgänge:** Anschluß an den Subwoofer-Ausgang des Verstärkers oder jeden anderen (geregelten) Niederpegel-Ausgang über ein einfaches oder ein Y-Kabel.

10 Einstellen der Bedienungselemente

A. Frequenzeinstellung

Die Frequenzeinstellung ändert die obere Trennfrequenz des Subwoofers, Der Einstellbereich reicht von 40Hz bis 140Hz; die Flankensteilheit beträgt 12dB/24dB Oktave. Der Regler sollte so eingestellt sein, daß Frontlautsprecher und Subwoofer optimal zusammenarbeiten; d.h. es sind weder "Frequenzlücken" vorhanden, noch findet eine Überbetonung bestimmter Grenzfrequenzen statt.

Durch Rechtsdrehen (im Uhrzeigersinn) wird die Trennfrequenz erhöht. Durch Linksdrehen (gegen den Uhrzeigersinn) wird sie gesenkt.

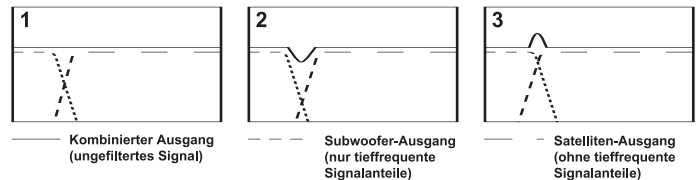

1. Ideale Trennfrequenz : flacher Frequenzgang
2. Übergangspunkt zu niedrig: Verursacht eine "Frequenzlücke" im kombinierten Frequenzgang
3. Übergangspunkt zu hoch: verursacht eine Überbetonung bestimmter Frequenzen im kombinierten Frequenzgang

B. Phasensteuerung

Der Phasensteuerung wird normalerweise auf 0° eingestellt. Allerdings kann manchmal in der Position 180° ein höherer Ausgangspegel erzielt werden, insbesondere, wenn der Subwoofer weit von den Satellitenlautsprechern entfernt ist.

C. PegelEinstellung

Mit der PegelEinstellung kann der Ausgangspegel des Subwoofers auf den Ausgangspegel der Satelliten- oder AV-Lautsprecher eingestellt werden. Durch Rechtsdrehen (im Uhrzeigersinn) wird der Ausgangspegel erhöht. Durch Linksdrehen (gegen den Uhrzeigersinn) wird er gesenkt.

D. Auto-/Manual-Schalter

Er schaltet die Stummschaltung (Muting) des Eingangs zu Ihrem Subwoofer ein/aus. Wenn Sie diesen Schalter in die Position 'Auto' stellen, schaltet der Subwoofer den Eingang automatisch stumm, wenn er ca. 45 Minuten spannungslos ist. Er nimmt den Betrieb automatisch wieder auf, wenn ein Signal angelegt wird. Wenn 'Manual' eingestellt ist, wird das Gerät niemals stumm geschaltet, selbst wenn kein Signaleingang vorliegt.

E. Erdungsanschluss

Erweitert die Kompatibilität. Verwenden Sie diesen Anschluss um Brummgeräusche, die durch Erdungsschleifen entstehen können, zu unterdrücken.

F. Musik/Kino

Mit diesem Schalter kann zwischen zwei Klangcharakteristiken gewählt werden: "Musik" sorgt für einen tiefen, klaren Bass; "Kino" sorgt für kinotypische Basseffekte.

G. Slope

Wird verwendet um den Frequenzübergang zwischen den Lautsprechern und dem Subwoofer einzustellen.



Fehlersuche

SYMPTOM	FEHLERBESEITIGUNG
Betriebsanzeige leuchtet nicht auf.	Vergewissern Sie sich, daß der Subwoofer an das Stromnetz angeschlossen ist. Überprüfen Sie (z.B. mit irgendeinem anderen Gerät), ob an der betreffenden Netzsteckdose Spannung anliegt. Bitte wenden Sie sich an Ihren Fachhändler.
Betriebsanzeige leuchtet immer noch nicht auf	Vergewissern Sie sich, daß alle Geräte eingeschaltet sind.
Betriebsanzeige leuchtet, jedoch kein Ausgangssignal aus dem Subwoofer.	PegelEinstellung überprüfen und ggf. korrigieren.  Überprüfen Sie, ob der entsprechende Hoch- oder Niederpegel-Ausgang am Verstärker aktiviert ist und so eingestellt ist, daß ein ausreichender Pegel an den Subwoofer übertragen wird. Vergewissern Sie sich, daß alle Anschlußkabel bzw. -stecker fest und ordnungsgemäß sitzen. Tauschen sie ggf. die Anschlußkabel aus.
Immer noch kein Ausgangssignal aus dem Subwoofer.	Bitte wenden Sie sich an Ihren Fachhändler.

6. ISTRUZIONI IN ITALIANO

5 Comandi e prese

Modello KHT Subwoofer Pannello posteriore

1. Prese ingresso linea
 2. Prese uscita passa-alto
 3. Terra Si / No
 4. Regolazione di livello
 5. Musica / Cinema
 6. Regolazione di frequenza
 7. Pendenza
 8. Interruttore di fase
 9. Indicatore luminoso di alimentazione
- Acceso 
 Spento 
10. Standby
 11. Interruttore ON/OFF (Interruttore Vacanze)
(230V Euro SP 3333 AA)
 12. Alimentazione a c.a. (230V UK SP 3333 AC)
(115V US SP 3333 AB)

8 Posizionamento/collegamento del cavo di alimentazione

Il subwoofer, poiché produce un suono a bassa frequenza non-direzionale, può essere posizionato in qualunque punto dell'ambiente, purché non troppo vicino all'ascoltatore. Tuttavia, per ottenere un suono quanto più pulito possibile si consiglia di provare il subwoofer in diverse posizioni. Viene fornito un cavo di alimentazione compatibile con le normative di messa a terra nazionali ed in conformità ai requisiti di sicurezza locali.

9 Collegamenti

Diffusori anteriori a gamma intera: in grado di produrre l'intera gamma di frequenze.

- A. Livello di linea:** collegato al circuito di elaborazione dell'amplificatore.
- B. Ingressi livello di linea:** collegati all'uscita del subwoofer su amplificatore mediante cavo singolo o a Y.

10 Regolazione dei comandi

A. Regolazione di frequenza

Il regolatore di frequenza modifica la frequenza di taglio superiore del subwoofer, con un intervallo effettivo di 40-140 Hz a 12dB/24dB per ottava. Regolare la frequenza in modo da ottenere la migliore integrazione tra i diffusori principali/secondari e il subwoofer.

La rotazione in senso orario aumenta la frequenza di taglio, mentre quella in senso orario la riduce.

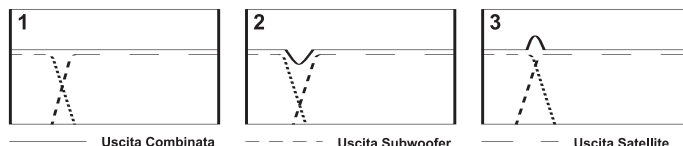

1. Crossover ideale - risposta piatta.
2. Frequenza di taglio troppo bassa: provoca una flessione nella risposta combinata.
3. Frequenza di taglio troppo alta: provoca un innalzamento nella risposta combinata.

B. Interruttore di fase

In genere l'interruttore di fase viene impostato a 0° ma a volte si ottiene un maggior livello d'uscita nella posizione a 180°, particolarmente se il subwoofer è molto distante dagli altoparlanti secondari.

C. Regolazione di livello

Il regolatore di livello consente di regolare il livello d'uscita del subwoofer in rapporto al livello d'uscita dai diffusori AV o secondari. Ruotare in senso orario per aumentare il livello d'uscita o in senso antiorario per ridurlo.

D. Interruttore Auto/Manual (automatico/manuale)

Si attiva/disattiva, silenziando i segnali in ingresso al subwoofer. Impostando questo interruttore sulla posizione automatica (Auto), il subwoofer instaura il silenziamento automatico dei segnali in ingresso dopo un'inattività di circa 45 minuti; riprendendo a lavorare istantaneamente se c'è un segnale. In modalità manuale (Manual), l'unità non viene mai silenziata, anche in assenza di segnale.

E. Terra In/Out

Per eliminare il ronzio causato da un eventuale anello di terra. In presenza di ronzio, provare la posizione out.

F. Musica/Cinema

Questo selettore permette di scegliere tra due caratteristiche sonore: posizione Music per bassi chiari e profondi; posizione Cinema per bassi di grande impatto.

G. Pendenza

Utilizzato per variare la curva di transizione tra sub-woofer e satelliti.



Individuazione delle anomalie

ANOMALIA	AZIONE
La spia di alimentazione non si accende.	<p>Verificare che il subwoofer sia collegato all'alimentazione di corrente e che gli eventuali interruttori presenti siano su ON.</p> <p>Controllare gli eventuali fusibili (spina compressa) o sezionatori sull'alimentazione che possano influenzare l'alimentazione del subwoofer.</p> <p>Per ulteriori informazioni rivolgersi al rivenditore.</p>
Se la spia di alimentazione resta ancora spenta	Verificare che l'apparecchiatura sia accesa.
Se la spia di alimentazione è accesa ma non arriva alcun suono dal subwoofer	<p>Controllare il regolatore di livello e regolarlo di conseguenza.</p> <p> Verificare che le uscite della sorgente (pre o finale) siano correttamente impostate, in modo da garantire un adeguato livello al subwoofer.</p> <p>Verificare che tutti i collegamenti tra il subwoofer e la sorgente siano stati realizzati in modo appropriato e modificarli se necessario.</p>
Se persiste l'assenza del suono.	Per ulteriori informazioni rivolgersi al rivenditore.

6. INSTRUCCIONES EN ESPAÑOL

5 Controles y conexiones

Panel trasero del Modelo KHT Subwoofer

1. Línea en el zócalo de entrada
2. Zócalos de salida pasa alto
3. Tierra / Flotante
4. Control de nivel
5. Música / Cine
6. Control de frecuencia
7. Caída
8. Controllo di fase
9. Luz indicadora de conexión a red  Encendido
Power OFF (desconectado) 
10. Interruttore Auto/Manual (automatico/manuale)
11. Interruptor ON/OFF (botón Vacaciones)
12. Entrada de corriente (CA) (230V Euro SP 3333 AA)
(230V UK SP 3333 AC)
(115V US SP 3333 AB)

8 Posicionamiento/Conexión a la red

Puesto que el sonido de baja frecuencia producido por el altavoz de bajos no es direccional, puede ser colocado en cualquier lugar de la habitación, aunque no debe ser colocado demasiado cerca del oyente. Si es posible, pruebe el altavoz en diferentes ubicaciones para encontrar el lugar en el que no se produce reverberación del sonido.

Se suministra un cable de conexión a la red de acuerdo con los requisitos del país y las regulaciones relativas a la toma de tierra.

9 Conexiones

Altavoces frontales capaces de producir frecuencias de amplia gama.

- A. **Línea de nivel** - conectada al bucle del procesador del amplificador.
- B. **Entradas de líneas de nivel** - conectadas a la salida de altavoces de graves del amplificador por medio de cable sencillo o en Y.

10 Ajuste de los controles

A. Control de frecuencia

El control de frecuencia cambia el umbral superior de la frecuencia del altavoz de graves. Su intervalo efectivo va desde 40 a 140 Hz a un régimen de 12 dB / 24 dB por octava. El control de frecuencia debe ajustarse para obtener la integración más suave entre los altavoces principal/satélite y los altavoces de graves.

El giro en el sentido de las agujas del reloj incrementa la frecuencia de corte y en sentido contrario la decremента.

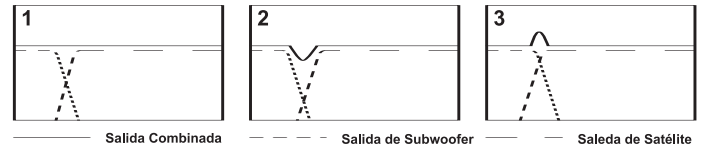

1. Frecuencia de cambio ideal. Respuesta plana.
2. El punto de frecuencia de cambio fijado demasiado bajo causa una depresión en la respuesta combinada.
3. El punto de frecuencia de cambio fijado demasiado alto causa una cresta en la respuesta combinada.

B. Controllo di fase

El Controllo di fase debe estar normalmente en 0°, pero algunas veces se puede obtener un mayor nivel de salida en la posición de 180°, especialmente cuando el altavoz de graves esta alejado de los altavoces satélite.

C. Control de nivel

El control de nivel ajusta el nivel de salida del altavoz de graves en relación con los altavoces AV o satélites. El giro hacia la derecha incrementa el nivel de salida y hacia la izquierda lo disminuye.

D. Conmutador Auto/Manual

Activa / desactiva el silenciamiento de la entrada al subwoofer. Al colocar este conmutador en la posición Auto, el subwoofer silenciará la entrada automáticamente si éste se mantiene inactivo durante alrededor de 45 minutos, y reanudará su funcionamiento apenas aparezca una señal. Si se coloca en Manual, la unidad nunca será silenciada, incluso cuando no haya una señal de entrada.

E. Tierra Si/No

Mejora la compatibilidad. Se usa para romper posibles lazos de tierra que causen zumbidos audibles.

F. Musica/Cine

Este conmutador selecciona una de estas características: Musica se selecciona para obtener graves profundos y limpios; Cine se selecciona para conseguir impacto en las películas.

G. Rampa

Usado para ajustar la transición entre altavoces y subgrave.

Localizacion de averias

SINTOMA	REMEDI0
La luz indicadora de red no se ilumina	<p>Compruebe que el altavoz de graves está conectado a la red y que los interruptores están activados</p> <p>Compruebe los fusibles o disyuntores de la red que puedan afectar a la falta de funcionamiento del altavoz</p> <p>Póngase en contacto con el proveedor del equipo para obtener asesoramiento.</p>
Si la luz indicadora de red sigue sin iluminarse	Asegúrese de que todo el equipo está conectado
Si la luz indicadora de red está iluminada pero el altavoz de graves no suena	<p>Compruebe y ajuste el control de nivel.</p> <p>Compruebe que las clavijas de salida del equipo principal están correctamente conectadas y ajústelas para proporcionar potencia suficiente para que funcione el altavoz de graves.</p>  <p>Compruebe que todas las conexiones entre el altavoz de graves y el equipo principal (fuente) están correctas y ajústelas según sea necesario.</p>
Si sigue sin emitir sonido	Póngase en contacto con el proveedor del equipo para obtener asesoramiento.

6. INSTRUÇÕES EM PORTUGUÊS

5 Comandos e fichas

Painel traseiro do Modelo KHT Subwoofer

1. Tomadas de entrada de linha
2. Tomadas de saída high pass
3. Terra Activada / Desactivada
4. Controlo de nível
5. Música / Cinema
6. Controlo de frequência
7. Corte
8. Controlo de fase
9. Luzes indicadoras de tensão
10. Interruptor Auto/Mamual
11. Interruptor "ON/OFF" (Interruptor Férias)
12. Entrada de corrente AC (230V Euro SP 3333 AA)
(230V UK SP 3333 AC)
(115V US SP 3333 AB)



8 Posicionamento/Ligações principais

Como o som sub-baixo (baixa frequência) produzido pelo subwoofer não é direccional, pode ser posicionado em quase todos os locais da sala, embora não deva ser colocado muito próximo do ouvinte. Se possível, tente colocar o subwoofer em diferentes posições até encontrar o melhor local para obter um som sem ressonância. É fornecido um cabo de ligação à corrente compatível com os padrões eléctricos nacionais e de acordo com as normas locais de segurança.

9 Ligações

Colunas frontais de gama completa - colunas capazes de produzir toda a gama de frequências.

- A. Nível de linha** - ligado ao loop do processador do amplificador.
- B. Terminais de entrada do nível de linha** - conectados aos terminais de saída do subwoofer e do amplificador por um cabo simples ou em "Y".

10 Ajuste dos comandos

A. Controlo de frequência

O controlo de frequência altera a frequência superior de corte do subwoofer. O seu intervalo efectivo é de 40 Hz a 140 Hz numa proporção de 12dB/24dB por oitava. O controlo de frequência deve ser ajustado para se obter a mais suave integração possível entre a coluna principal/ satélite e o subwoofer.

A rotação no sentido dos ponteiros do relógio aumentará a frequência de corte e a rotação no sentido inverso diminuirá a frequência de corte.

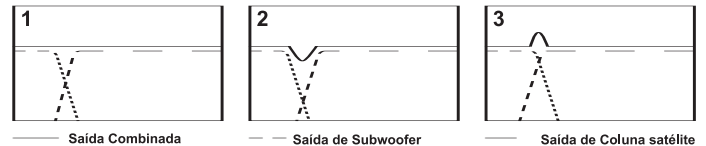

1. Confluência Ideal - Resultado monótono.
2. Ponto de confluência fixado demasiado baixo - Provoca descidas nas respostas combinadas.
3. Ponto de confluência fixado demasiado alto - Provoca elevações nas respostas combinadas.

B. Controlo de fase

O controlo de fase será fixado normalmente a 0° mas algumas vezes pode-se conseguir um maior nível de saída numa posição a 180°, nomeadamente quando o subwoofer se encontra longe das colunas satélites.

C. Controlo de nível

O controlo de nível ajusta o nível de saída do subwoofer em relação ao nível de saída da coluna satélite ou AV. A rotação no sentido dos ponteiros do relógio permite aumentar o nível de saída e a rotação no sentido inverso permite diminuir o nível de saída.

D. Interruptor Auto/Manual

Este interruptor permite activar/desactivar a entrada do subwoofer. Se definir este interruptor para a posição Auto, o subwoofer silenciará a entrada automaticamente se ficar inactivo durante mais de 45 minutos. O funcionamento será retomado instantaneamente após a detecção do sinal. Se estiver definido para Manual, o aparelho nunca será silenciado, mesmo não havendo entrada de sinal.

E. Terra Ligado/Desligado

Melhora a estabilidade. Usado para evitar retornos de terra no caso de ruído audível.

F. Música/Cinema

Este interruptor selecciona um dos dois modos: Música é seleccionado para fornecer baixos mais profundos e claros; Cinema é seleccionado para oferecer um impacto mais cinéfilo.

G. Corte

Usado para ajustar o corte (frequência) entre as colunas e o subwoofer.

Detector de falhas

FALLHAS	SOLUÇÕES
O indicador luminoso de tensão não se acende.	Verifique se o subwoofer está ligado à corrente e se todos os interruptores estão ligados. Verifique todos os interruptores (incluindo a tomada) ou corta-circuitos da tomada que possam afectar a chegada de corrente ao subwoofer. Contacte o seu fornecedor para mais conselhos.
Se o indicador luminoso de tensão continua sem se acender.	Verifique se todo o equipamento está ligado.
Se o indicador luminoso de tensão está aceso mas não há som do subwoofer.	Verifique e ajuste o controlo de nível.  Verifique se as fichas de saída do equipamento principal estão correctamente ligadas e ajustadas para fornecerem um nível suficiente de energia ao subwoofer. Verifique se todas as conexões entre o subwoofer e o equipamento principal estão correctas e ajustadas convenientemente.
Se ainda não há som.	Contacte o seu fornecedor para mais conselhos.

6. NEDERLANDSE HANDLEIDING

5 Regelaars en aansluitingen

KHT Subwoofer achterpaneel

1. lijn-niveau ingangbussen
2. luidspreker-niveau uitgangsbussen
3. Aarding Ja / Ne
4. Niveauregeling
5. Muziek / Cinema
6. Instelling voor de overgangs-frequentie
7. Flanksteilheid
8. Fases regelaar
9. Aan/uit indicatielampje
10. Auto/handbedienings schakelaar
11. Netschakelaar
12. Aansluiting voor netkabel



(Vakantiestand)
(230V Euro SP 3333 AA)
(230V UK SP 3333 AC)
(115V US SP 3333 AB)

8 Plaats en aansluiting van het netsnoer

Omdat het oor de herkomst van de lage frequenties van het subbas-geluid niet kan waarnemen, kunt u de subwoofer plaatsen waar het u uitkomt. Plaats het toestel echter niet te dicht bij de luisteraar. Probeer verschillende plaatsen in de woonkamer en kies de optimale plaats voor een zuiver laagweergave. Het bijgeleverde netsnoer beschikt over de juiste aardingsaansluiting en voldoet aan de plaatselijke veiligheidsnormen.

9 Aansluitingen

De frontluidsprekers zijn Full Range luidsprekers die het volledige frequentiespectrum weergeven.

- A. Lijnniveau** - aangesloten op de processor in - en uitgangen van de versterker.
- B. Ingangen lijnniveau (line level)** - aansluiten op de subwooferuitgang van de versterker met een enkelvoudige of een 'Y'-kabel.

10 Bediening van de regelaars

A. Instelling voor de overgangsfrequentie

Met deze Instelling kiest u tot welke frequentie de actief blijft. Het bereik van deze instelling loopt van 40Hz tot 140Hz, met een filtersteilheid van 12 dB / 24 dB per octaaf. Stel deze regelaar zodanig in, dat u de soepelste overgang tussen hoofd- en satellietluidsprekers en de subwoofer bereikt. Als u de regelaar met de klok mee draait (de overgangsfrequentie hoger legt), verbreedt u het werkingsgebied van de 20B. Tegen de klok in gaand versmalt u dit.

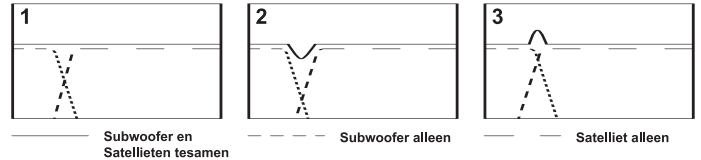

1. Ideale overgang - vlakke responscurve
2. Overgangspunt te laag - veroorzaakt een kuil in de totale frequentiecurve
3. Overgangspunt te hoog - veroorzaakt een berg in de totale frequentiecurve

B. Fase regelaar

De fases regelaar staat normaal gezien op 0°. Soms kunt u echter een hoger uitgangsniveau bereiken door de regelaar op 180° te zetten, vooral als de subwoofer ver weg staat van de satellietluidsprekers.

C. Niveauregeling

Met de niveauregeling regelt u het volume van de subwoofer in verhouding tot het volume van de satellietluidsprekers of de AV-luidsprekers. Draai met de klok mee om het volume te verhogen. Draai in de andere richting om het volume te verlagen.

D. Auto/handbedienings schakelaar

Maakt afkoppeling van de ingang van de subwoofer mogelijk. In 'auto' positie koppelt de subwoofer zijn ingang automatisch af na ± 45 minuten stilte, om meteen na binnenkomst van enig signaal weer actief te worden. In de stand 'manual' wordt de ingang nooit afgekoppeld.

E. Aarding in/uit

Dient om mogelijke aardlussen, die brom veroorzaken, te onderbreken.

F. Muziek/Cinema

'Muziek' is ideaal voor muziekweergave met een diep, droog laag; 'Cinema' zorgt voor een imponerend laag, zoals we dat bij film wensen.

G. Steilheid

Past de steilheid van de overgang tussen subwoofer en hoofd- en satellietluidsprekers aan.

Opsporen van storingen

STORING	VERHELPEN VAN DE STORING
Het aan/uit indicatielampje wil niet branden.	<p>Controleer of het netsnoer van de subwoofer aangesloten is op een stopcontact en de aan/uitschakelaar ingeschakeld is.</p> <p>Controleer de smeltzekeringen of stroomonderbrekers van het stroomcircuit waarop de subwoofer is aangesloten.</p> <p>Raadpleeg uw dealer voor meer informatie.</p>
Als het aan/uit indicatielampje nog steeds niet oplicht.	Vergewis u ervan dat alle toestellen ingeschakeld zijn.
Het aan/uit indicatielampje licht op, maar de subwoofer geeft geen geluid.	<p>Controleer de volumeregeling en stel deze in.</p> <p> Ga na of de uitgangspluggen van de geluidsbron het juiste signaal voeren, op het juiste niveau stann en voldoende vermogen leveren om de subwoofer aan te drijven.</p> <p>Controleer alle aansluitingen tussen subwoofer en de geluidsbron en voer indien nodig correcties uit.</p>
Ik hoor nog steeds geen geluid.	Neem contact op met uw handelaar of de importeur.

6. DANSKE INSTRUKTIONER

5 Betjeningsknapper og stik

KHT Subwoofer bagside

1. Bøsninger for lineindgange
2. Højpas udgangsbøsninger
3. Jordforbindelse Tænd / Sluk
4. Niveauekontrol
5. Music / Cinema Omskifter
6. Frekvenskontrol
7. Omskifter for Flankestøjhed
8. Fase-regulering
9. Indikator for net spænding



10. Omskifter for Auto/Manual drift
11. TÆND/SLUK afbryder (Hoved afbryder)
12. AC net indgang (230V Euro SP 3333 AA)
(230V UK SP 3333 AC)
(115V US SP 3333 AB)

8 Placering / Tilslutning af strøm

Da den lavfrekvente sub-bas lyd fra subwooferen ikke er retningsbestemt kan den anbringes næsten alle steder i rummet, dog bør den ikke anbringes for tæt på tilhøreren. Afprøv forskellige positioner for at finde det bedste sted for en resonans fri lyd. Udstyret leveres med strømstik med jord, der passer til den nationale standard.

9 Forbindelser

Front højttalere,- højttalerne der er i stand til fuld gengivelse i hele frekvensområdet.

- A. Line niveau** - forbindes til forstærkerens processor loop.
- B. Line niveau indgang** - forbindes til subwoofer udgang på forstærkeren med en enkelt- eller en 'Y' ledning.

10 Justering af betjeningsknapperne

A. Frekvenskontrol

Frekvenskontrollen kontrollerer subwooferens øverste afskærings frekvens, dens effektive område ligger fra 40 Hz til 140 Hz med 12 dB /24 dB pr. oktav. Frekvenskontrollen bør justeres for at opnå det bedste samspil mellem hoved/satellithøjttalerne og subwooferen. Ved at dreje den i urets retning øges afskærings frekvensen og ved at dreje den mod urets retning formindskes.

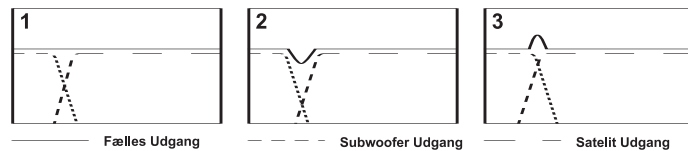

1. Ideel overgangsfrekvens - Jævn gengivelse.
2. Overgangsfrekvens sat for lavt - medfører fald i den kombinerede gengivelse.
3. Overgangsfrekvens sat for højt - medfører en pukkel i den kombinerede gengivelse.

B. Fase regulering

Faseo regulering er normalt sat til 0° men større udgangsniveau kan nogle gange opnås i 180° positionen, specielt når subwooferen er anbragt langt fra satellithøjttalerne.

C. Niveauekontrol

Niveaue kontrollen regulerer subwooferens udgangsniveau i forhold til satellit- eller AV højttalerne. Ved at dreje den i urets retning øges udgangsniveauet ved at dreje den mod urets retning formindskes udgangsniveauet.

D. Auto/Manual omskifter

Når denne omskifter står i "Auto" position vil subwooferen automatisk gå i standby og afbryde indgangssignalet efter ca. 45 minutters, når der ikke tilføres noget audio-signal. Omvendt vil subwooferen straks være operativ, så snart der tilsluttes et audiosignal. Når omskifteren står i stillingen "manual", vil subwooferen konstant være tændt og spilleklar.

E. Ground In/Out

Omskifter som bruges til at bryde eventuelle "stelsøjfer", der kan forårsage brum og støj.

F. Music/Cinema-omskifter

Denne omskifter bestemmer subwooferens basale lydopsætning: Indstillingen Music giver en dyb, ren og velopløst baslyd, mens indstillingen Cinema understreger bassens dynamiske slagkraft og dramatik.

G. Slope

Med denne knap justeres overgangsområdet mellem subwooferen og anlæggets hovedhøjttalere.

Fejlfinding

FEJL	MIDDEL
Net indikatoren lyser ikke.	Check at stikket til subwooferen er sat i stikkontakten, og at der er tændt for den. Check alle sikringer og hovedstrømbryderen, som har indflydelse på strømmen til subwooferen. Kontakt forhandleren for yderligere detaljer.
Hvis net indikatoren stadig ikke tænder.	Check at der er tændt for hele udstyret.
Hvis net indikatoren lyser, men der ingen lyd kommer fra subwooferen.	Check og justér lydniveauet  Check at udgangsstikket på dit anlæg er korrekt monteret og justeret til passende niveau for at trække subwooferen. Check at alle forbindelser mellem subwooferen og dit anlæg er korrekt monteret og justeret, om nødvendigt.
Hvis der stadig ikke er nogen lyd.	Kontakt din forhandler for yderligere detaljer.

7. WALL MOUNTING

(F) Installation Murale (D) Schablone für Wandmontage (I) Montaggio a Parete (ES) Montage en Pared (P) Montagem na parede (NL) Wandmontage (DK) Væg Montering

WARNING

- (GB) Warning - No attempt should be made to install these loudspeakers unless you are sure that you will not be cutting through electric cables, water or gas pipes, or supporting joists.
- (F) Avertissement - Avant de procéder à l'installation de ces H.P., vérifiez bien que vous ne risquez à aucun moment de sectionner des câbles électriques, des canalisations d'eau ou de gaz ou toute autre élément de ce type.
- (D) Warnung - Diese Lautsprecher sollten wirklich nur dann installiert werden, wenn Sie sicher sind, daß Sie nicht Stromkabel, Wasserleitungen, Gasrohre oder T-Träger durchbohren oder durchschneiden.
- (I) Avvertenza - Non cercare d'installare gli altoparlanti prima di aver verificato l'assenza di cavi elettrici, tubazioni dell'acqua e del gas e di travetti nella zona d'installazione.
- (ES) Atención - No se debe intentar instalar los altavoces, a menos que se esté seguro de que no se va a dañar un cable eléctrico, tuberías de gas o agua o viguetas de soporte.
- (P) Aviso - Aquando da instalação destes altifalantes certifique-se de que não danifica cabos elétricos, canos de água ou de gás ou vigas de suporte.
- (NL) Waarschuwing - Installeer deze luidsprekers enkel als u zeker weet dat u geen elektrische leidingen, water- of gasleidingen of steunbalken zult raken.
- (DK) Advarsel - Kontrollér ved installationen, at der ikke er risiko for, at der bores hul i elektriske kabler, vand- eller gasrør eller bærende dele i væggen.

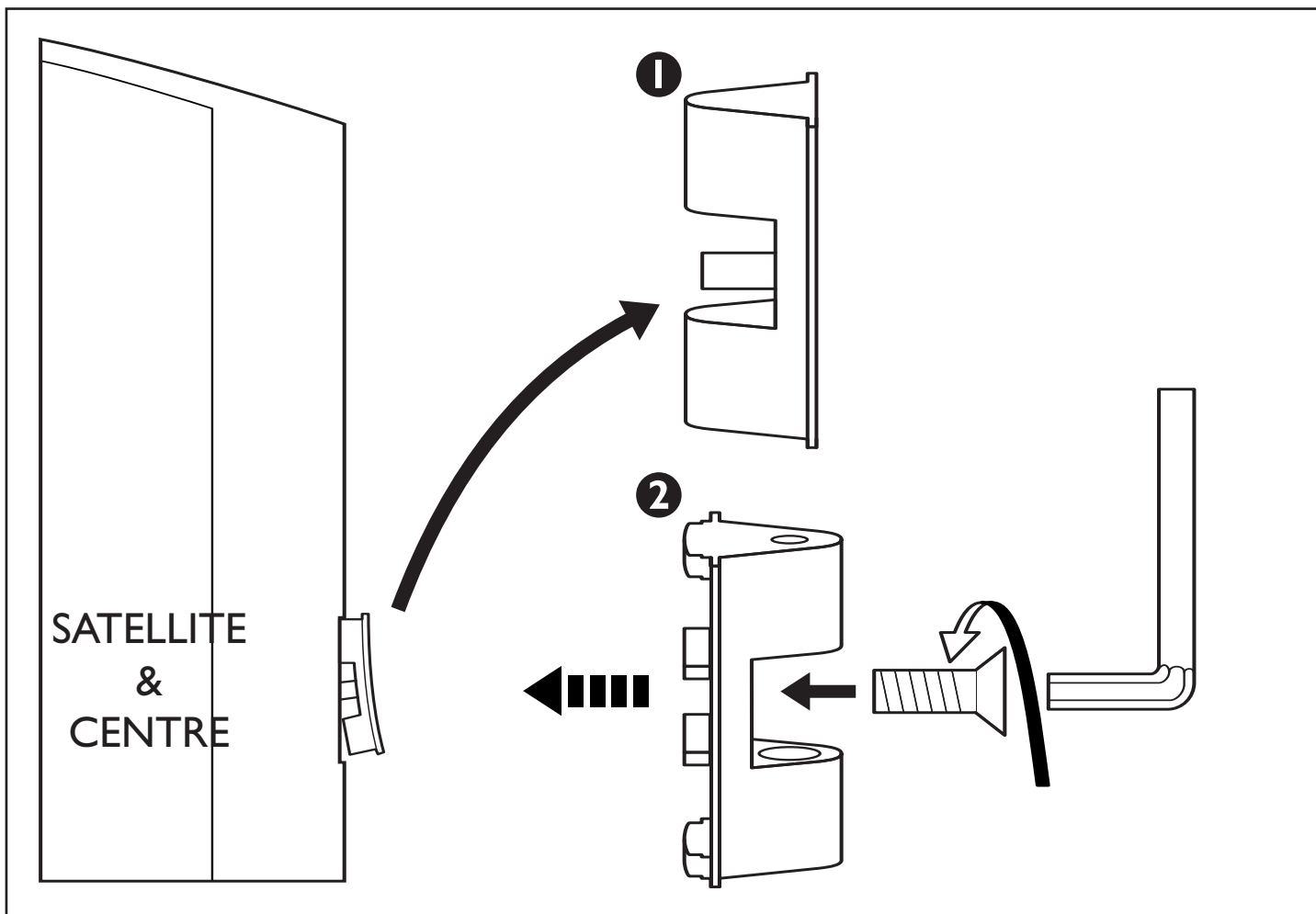

7. WALL MOUNTING

(F) Installation Murale (D) Schablone für Wandmontage (I) Montaggio a Parete (ES) Montaje en Pared (P) Montagem na parede (NL) Wandmontage (DK) Væg Montering

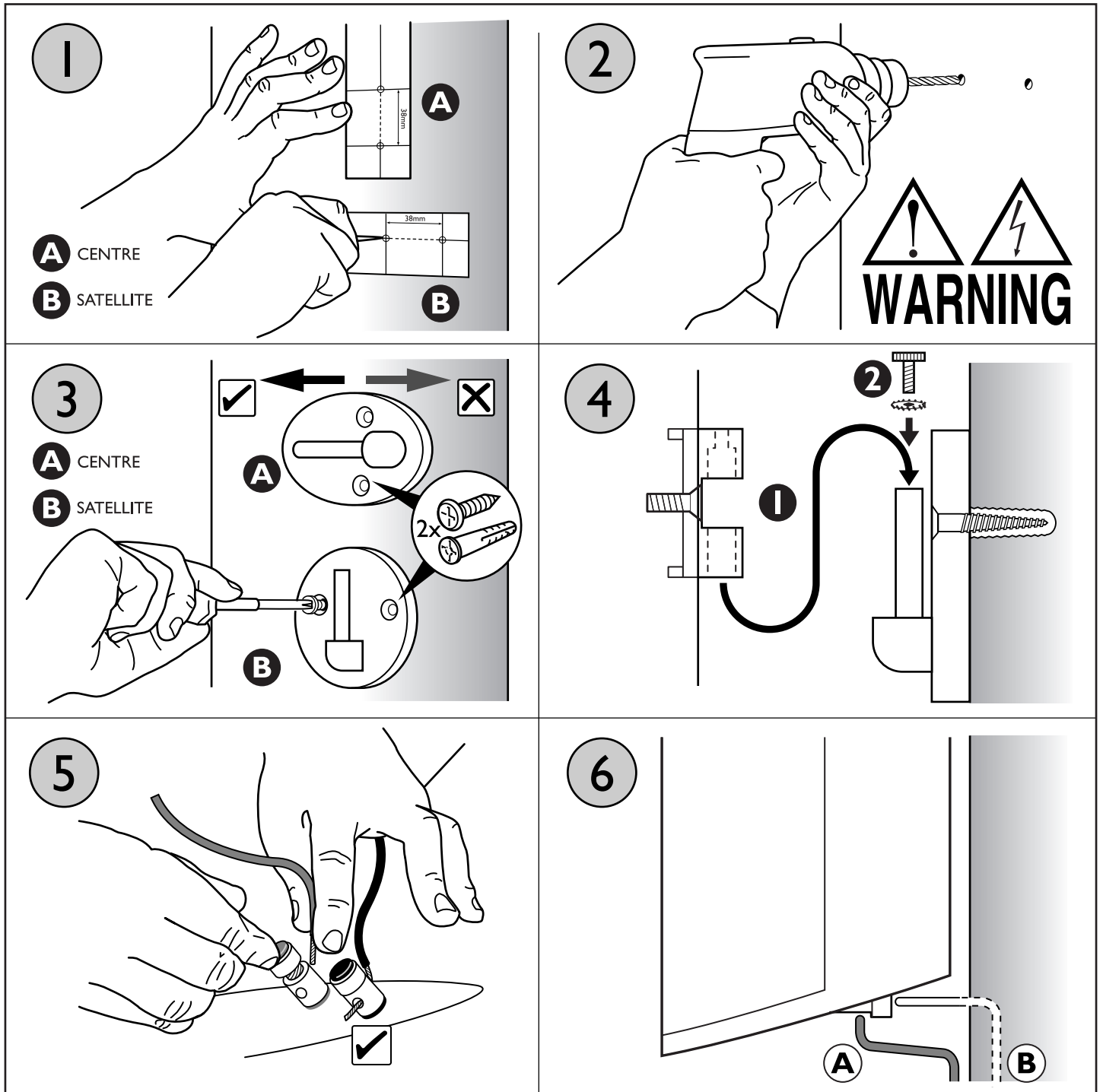

Wall Mounting Template

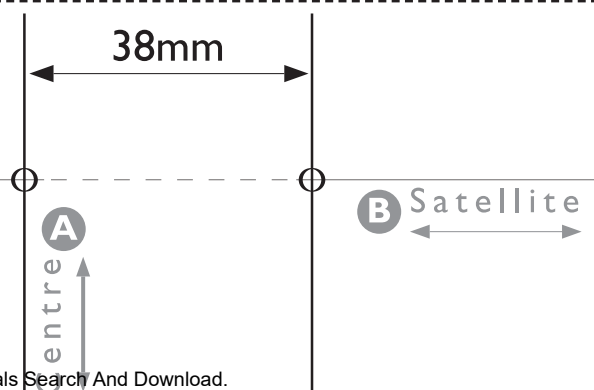

8. POSITIONING

(F) Positionnement (D) Aufstellung (I) Posizionamento (ES) Posicionamiento (P) Posicionamento (NL) Plaats en aansluiting van het netsnoer (DK) Placering

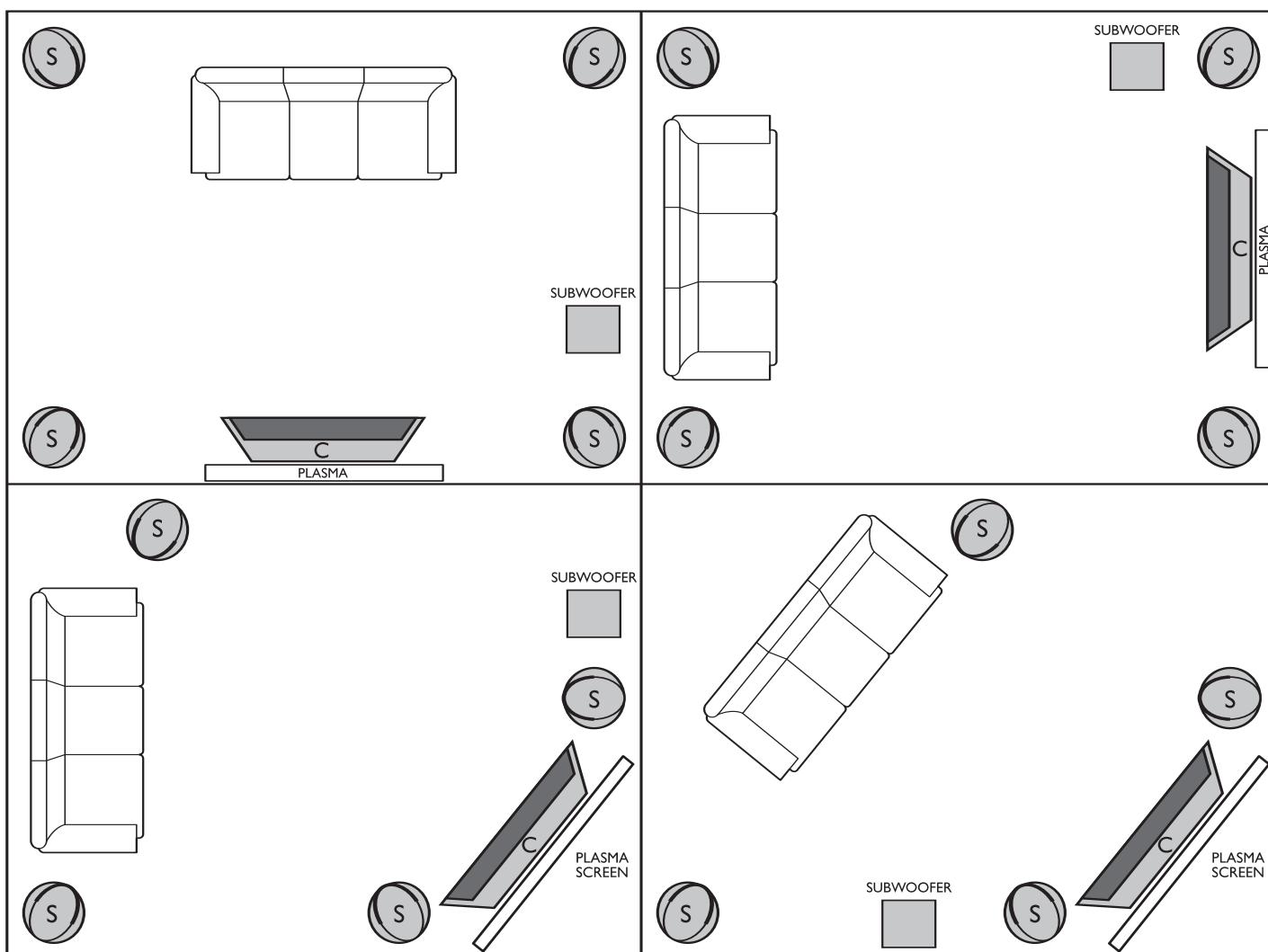
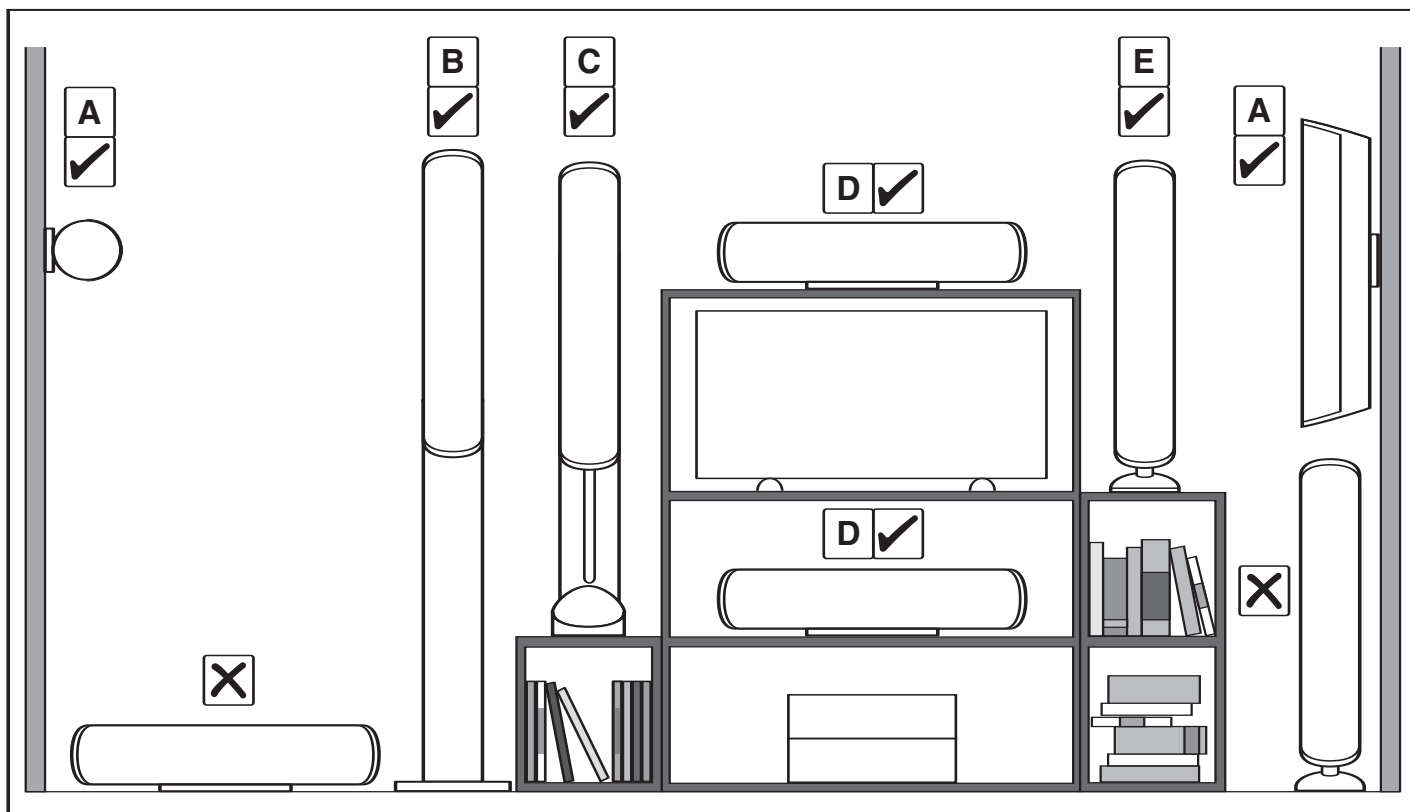

9. CONNECTIONS

(F) Connexions (D) Anschlüsse (I) Collegamenti (ES) Conexiones (P) Ligações (NL) Aansluitingen (DK) Forbindelser

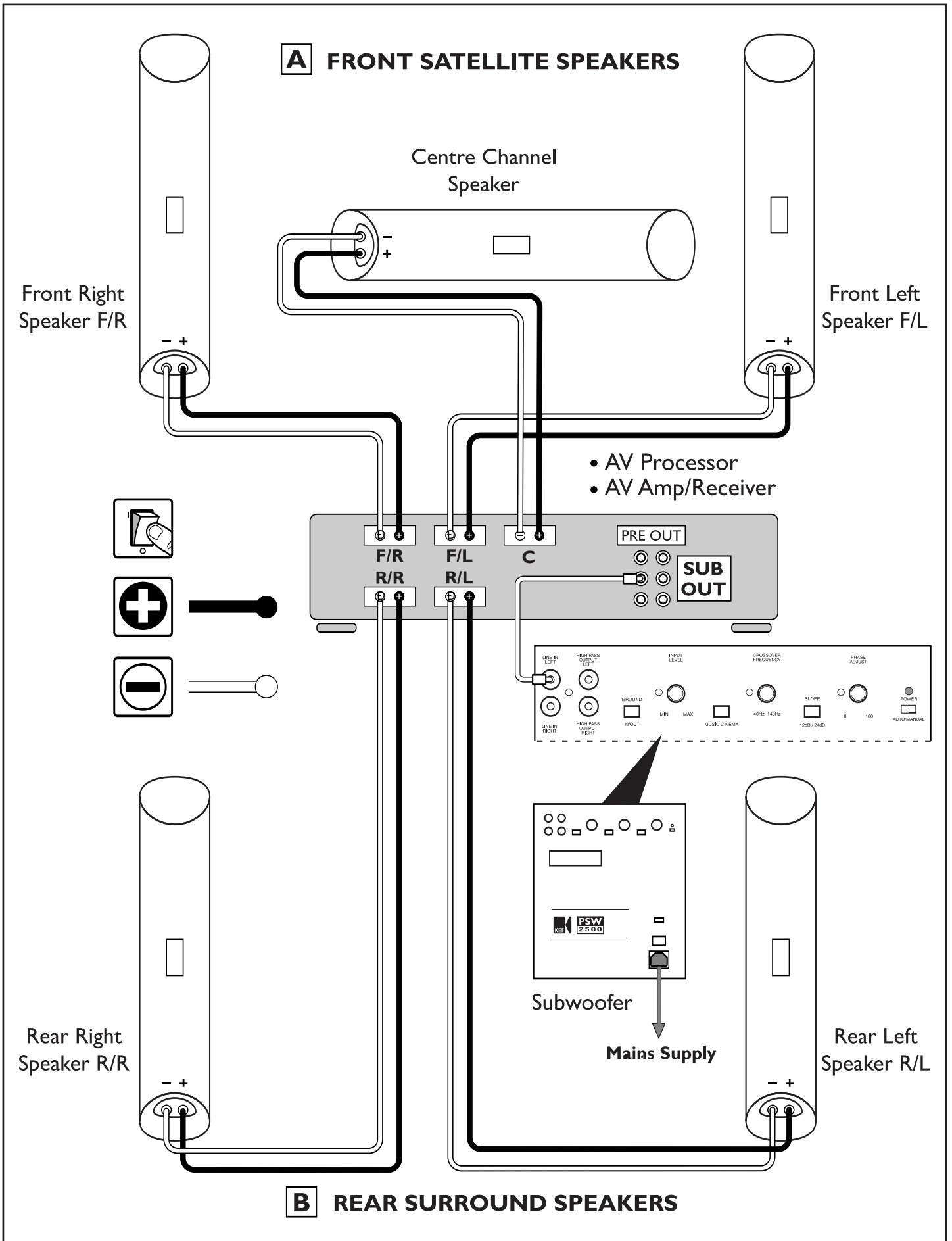

9. CONNECTIONS

(F) Connexions (D) Anschlüsse (I) Collegamenti (ES) Conexiones (P) Ligações (NL) Aansluitingen (DK) Forbindelser

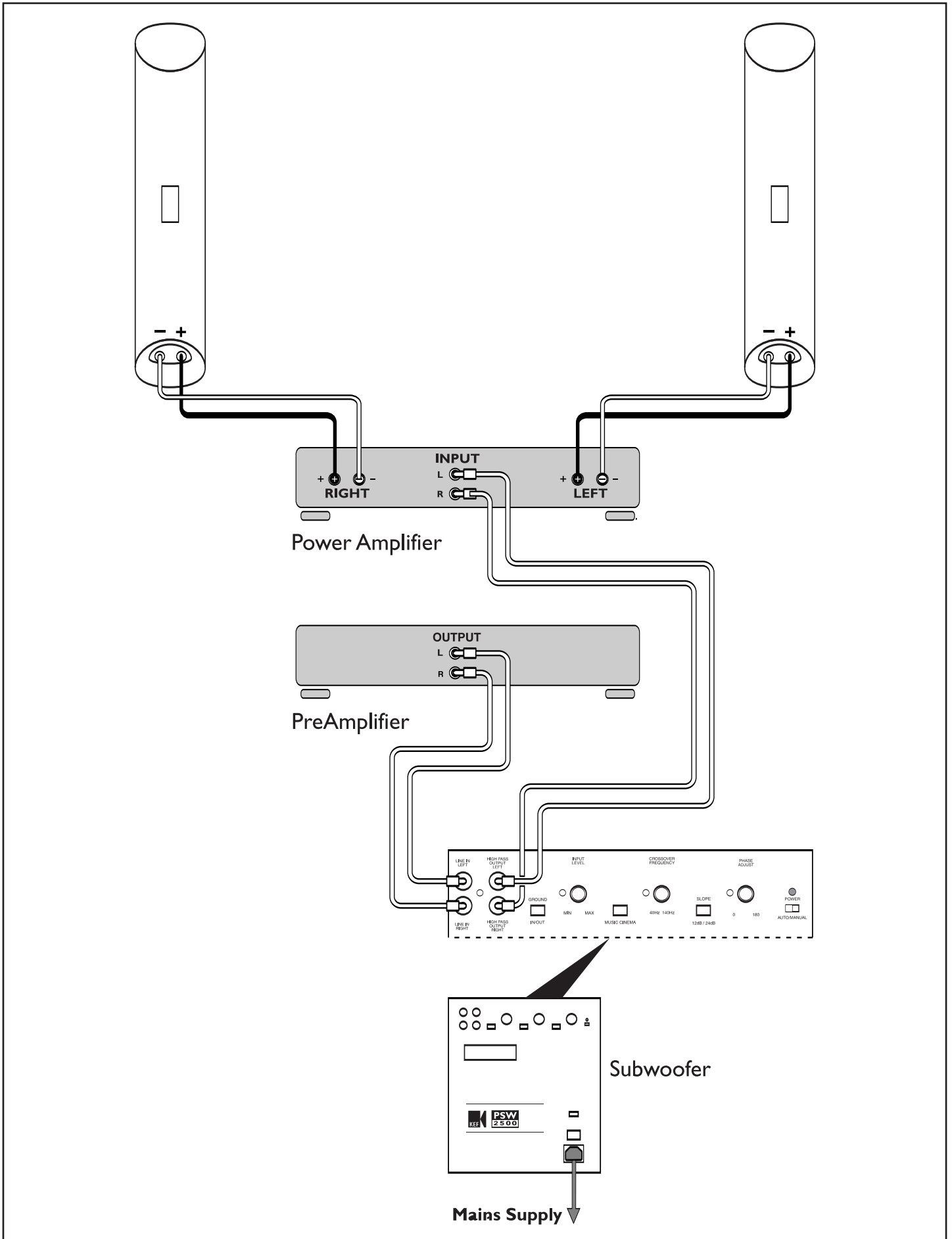

10. ADJUSTING THE CONTROLS

(F) Réglage des commandes (D) Einstellen der Bedienungselemente (I) regolazione dei comandi (ES) Ajuste de los controles (P) Ajuste dos comandos (NL) bediening van de regelaars (DK) Justering af betjeningsknapperne

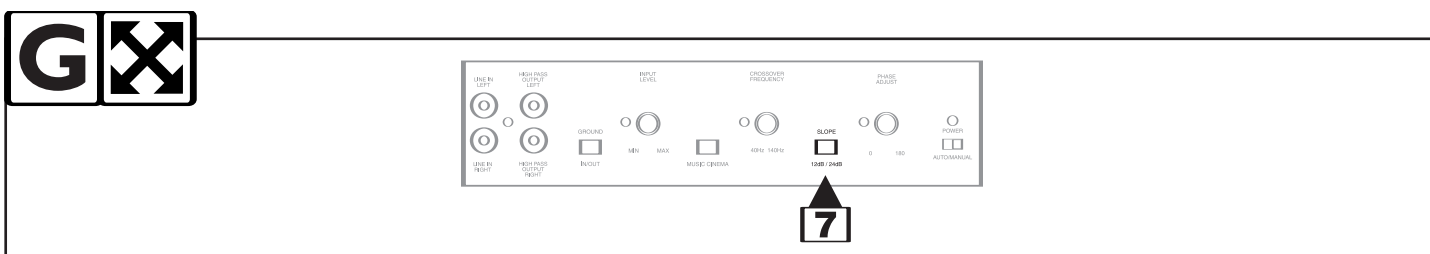
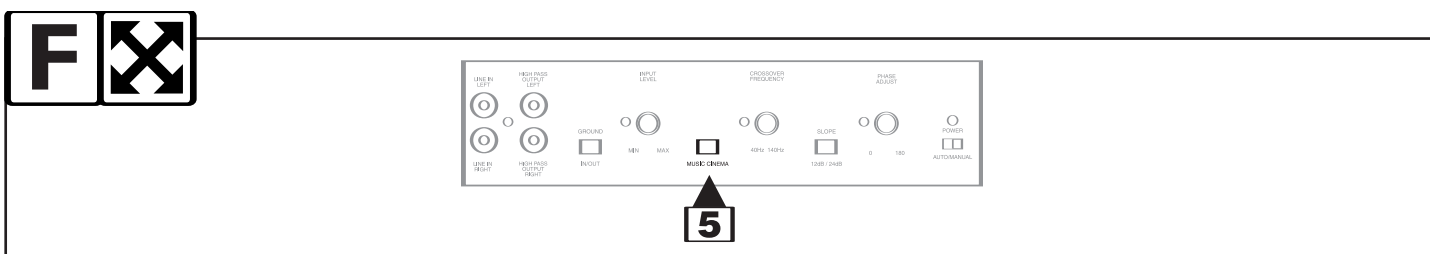
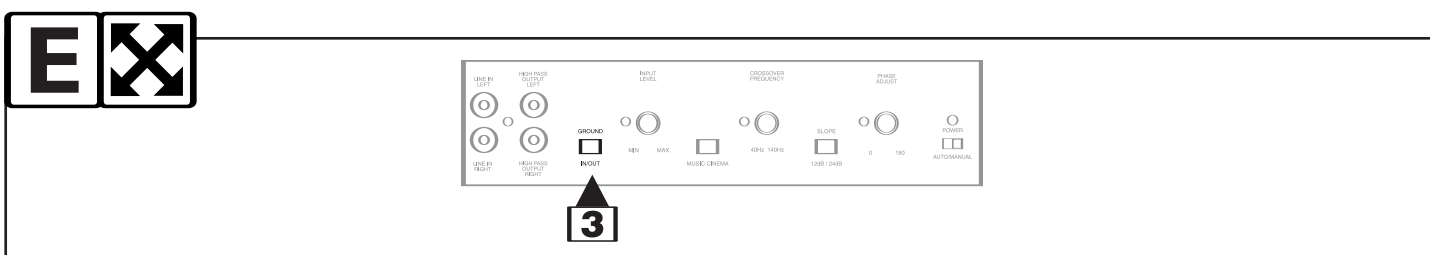
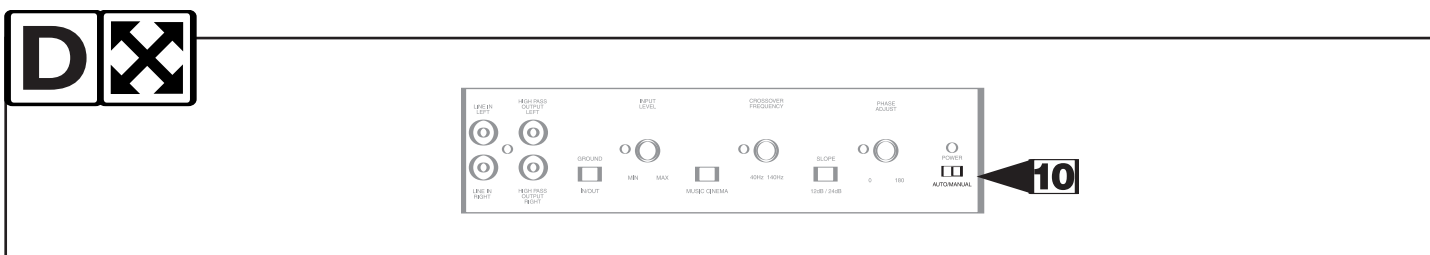
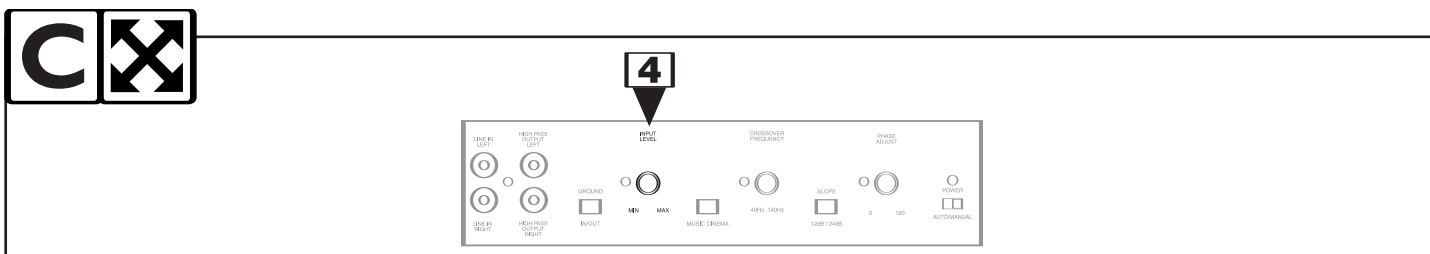
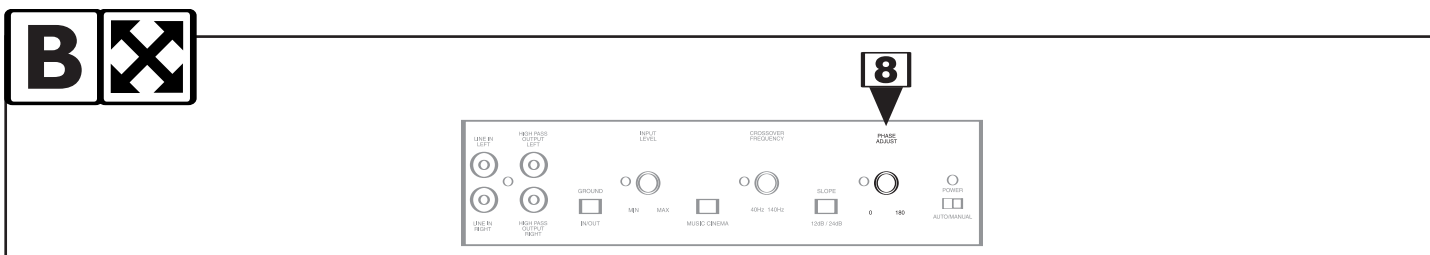
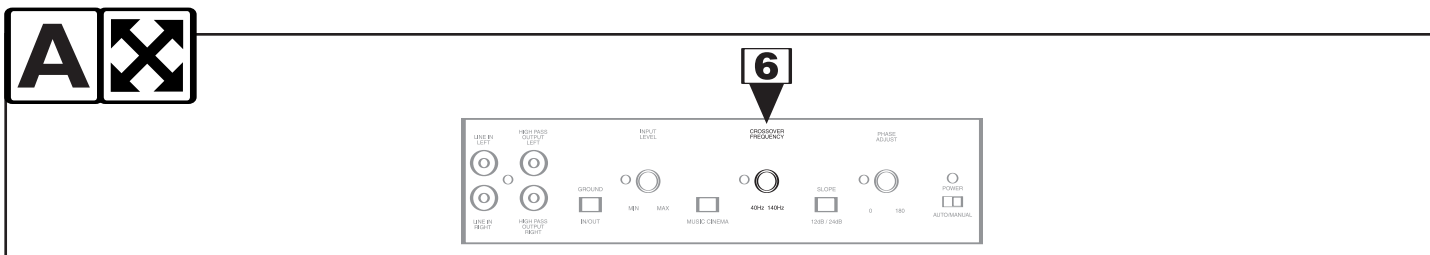

11. SPECIFICATIONS

(F) Spécifications (D) Technische Merkmale (I) Specifiche (ES) Especificaciones (P) Especificações (NL) Technische gegevens (DK) Specifikationer

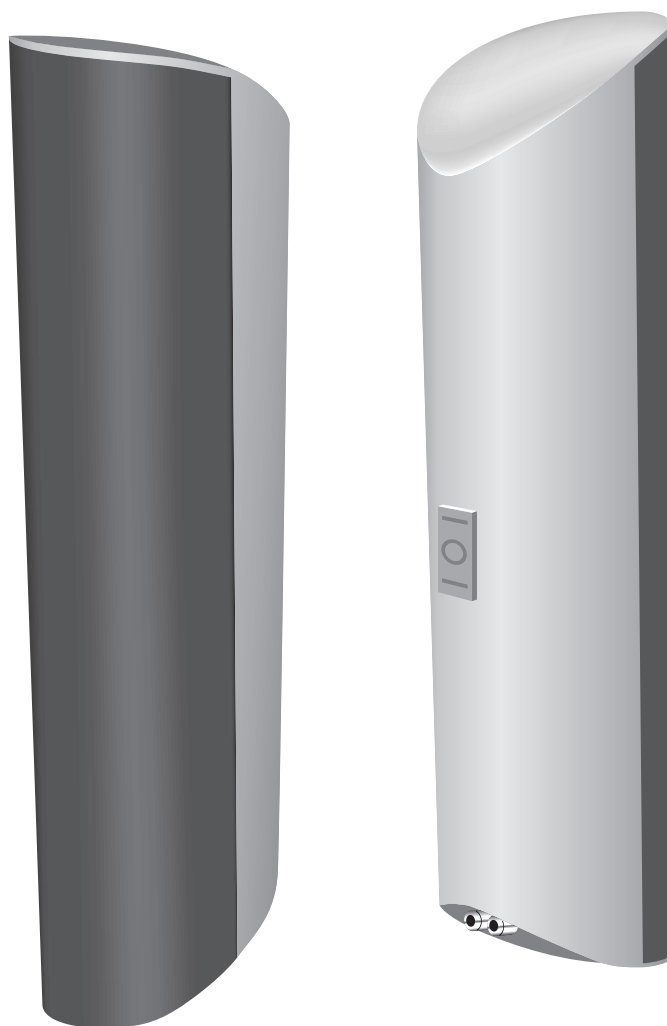

Model	HTS5001 Satellite / HTC5001 Centre Channel	
Type	Three way closed box	
Drive Units	1 x 75 mm (3 in.) UNI-Q®, 15 mm (0.6 in.) aluminium HF 2 x 75 mm (3 in.) LF	
Crossover Frequencies	300 Hz - 3 kHz	
Frequency range (± 3 dB)	100 Hz - 30 kHz	
Amplifier Requirement	10 - 100 Watts	
Sensitivity (2.83 V / 1 m)	87 dB	
Maximum Output	104 dB SPL @ 1 m	
Impedance	8 Ω	
Net Weight	2.3 kg (5.0 lbs)	
Dimensions (Satellite H x W x D)	mm	419 x 88 x 127
	in.	16.5 x 3.46 x 5.0
Dimensions (Centre H x W x D)	mm	88 x 419 x 127
	in.	3.46 x 16.5 x 5.0
Finish	Silver	
KEF AUDIO reserve the right, in line with continuous research and development, to amend or change specifications without prior notice. E. & O.E.		

11. SPECIFICATIONS

(F) Spécifications (D) Technische Merkmale (I) Specifiche (ES) Especificaciones (P) Especificações (NL) Technische gegevens (DK) Specifikationer



Model	PSW 2500
Type	Powered Subwoofer
LF Drive Unit	1 x 250 mm (10 in.)
Frequency range	15Hz - 140Hz
Amplifier	250 Watts built in
Maximum Output (SPL)	108 dB
Low Level Signal Inputs	RCA phono sockets
Low Level Signal Outputs	RCA phono sockets (Actively filtered at 12dB/octave @ 130 Hz)
Enclosure Type	Closed box
Internal Volume	17 litres
Net Weight	14.5 kg (31.9 lbs)
Dimensions (H x W x D)	mm 360 x 495 x 325
	in. 14.2 x 19.5 x 12.8
Power Requirements	115 V ac ~, 60 Hz 230 V ac ~, 50 Hz
Power Consumption	220 VA
Cabinet Finish	Silver
KEF AUDIO reserve the right, in line with continuous research and development, to amend or change specifications without prior notice. E. & O.E.	



KEF AUDIO (UK)

Eccleston Road, Tovil, Maidstone, Kent, ME15 6QP UK
Telephone: +44 (0) 1622 672261 Fax: +44 (0) 1622 750653

www.kef.com

KEF AMERICA

10 Timber Lane, Marlboro, New Jersey, 07746 USA.
Telephone: (1) 732 683 2356 Fax: (1) 732 683 2358

www.kefamerica.com

Free Manuals Download Website

<http://myh66.com>

<http://usermanuals.us>

<http://www.somanuals.com>

<http://www.4manuals.cc>

<http://www.manual-lib.com>

<http://www.404manual.com>

<http://www.luxmanual.com>

<http://aubethermostatmanual.com>

Golf course search by state

<http://golfingnear.com>

Email search by domain

<http://emailbydomain.com>

Auto manuals search

<http://auto.somanuals.com>

TV manuals search

<http://tv.somanuals.com>