

User Manual

DVB-T Receiver UFD 574/S With Hard Disk



KATHREIN

Antennen · Electronic

Preface

Dear customer,

This user manual is thought to help you make the best use of the many functions your new DVB-T receiver offers.

DVB-T is a television standard which will provide optimum reception, without ghosts or any other disadvantages conventional terrestrial television brings about, even if you merely use a suitable indoor antenna.

We have composed the instructions as plain and short as possible. In order to give you an understanding of certain terms, we have compiled an encyclopaedia at the end of this manual.

The power switch of the receiver satisfies the eco-friendliness aspects. We therefore would ask you to disconnect your receiver whenever you are not going to use it for any length of time in order to save electricity. To spend only a modicum of energy in case of shorter intervals of absence, please switch the receiver to stand-by.

We trust your receiver will always provide high-quality reception and wish you much pleasure with it.

The KATHREIN-Team

Important Notes

However, if you have – against our expectations - any trouble with your receiver, please contact your local dealer or call our hotline:

Tel: +49 (0) 80 31/18 47 00

Fax: +49 (0) 80 31/18 46 76

Your receiver is factory-set with the latest software version in each case. We are anyway always keen to have the software versions meet with our customers requirements and with the best available technology. Find more information on this in chapter 'software and channel list updates'.

Keep the original packing for any reconsignment!

In consequence of the design, a hard disk is susceptible to shock. It is properly protected against damage on reconsignment only if the receiver is sent back in the original packing!

Improper packing on reconsignment causes loss of any claim under guarantee for the hard disk!

Radio Programmes



Currently no radio programmes are being broadcast on the radio channels. However, this may change in future. Then you will be able

to change over from TV to radio with the  TV/(Radio) key. Operation will be carried out along the same lines of TV operation.

Contents

Preface	2
Radio Programmes.....	2
Contents	3
Safety Instructions	5
Installation	6
Factory Setting of the Receiver.....	7
Control Elements, Indications and Connections	8
View Front Panel.....	8
View Back Panel.....	8
Control elements and indications on the front panel.....	8
Control elements and connections on the back panel.....	8
Remote Control/Menu Functions	9
RC 660 Remote Control.....	10
Alphanumerical Assignment of Number Keys on the Remote Control.....	10
Notes regarding Operation	11
Language Selection.....	11
Menu Concept.....	11
Alphanumerical Entries.....	11
Connection and Initiation	12
Antenna Connection.....	12
Presetting of the receiving Antenna.....	12
TV/VCR/AUX Connection.....	12
Audio Connection.....	12
Dolby Connection.....	12
Putting Batteries in the Remote Control.....	12
Initiation	13
The first Steps.....	13
Initiation with BZD 30 indoor Antenna.....	14
On-Screen Display OSD	15
Important Information displayed on the Screen.....	15
Help Function.....	15
Channel Confirmation TV.....	16
Problem Report.....	16
Channel List TV.....	17
Videotext/Subtitles	18
Videotext.....	18
Subtitles.....	18
Programme Selection	19
Selecting a TV Programme.....	19
Reception Status.....	19
Selecting a TV Programm with the Number Keys (numeric character entry).....	21
Switching to Radio Channel Reception.....	21
Timer Settings	22
VPS Signal.....	23
Sound Settings	24
Adjusting the Volume.....	24
Stereo and Dual-Channel Sound Reproduction.....	24
AC 3.....	24
Mute Function.....	25
Channel List	26
Selecting the Channel last received.....	26
Favourite Programmes.....	26
Alphabetical Channel Search.....	30
Channel sort Function.....	31
Deleting Channels.....	31
Adding channels manually.....	32
Programme Overview	34
EPG.....	34
Timer Programming via EPG.....	35
Hard Disk Recorder	37
Recording.....	37
Hard Disk Capacity.....	37
Instantly Recording (OTR/One Touch Recording).....	37

Contents

Recording Manually	37
Timer Recording	38
Stopping the Recording	38
Special Functions	39
Replay and Record	39
Replay	39
Setting and Deleting Indices	41
Delayed Replay	41
Audio Mode	41
Search	41
Visible Search	41
Time-Controlled Search	41
Freeze Image	41
Slow Motion	41
Breakpoint	42
Stopping	42
Deleting	42
Password	43
Factory Settings	43
Password Entry	43
Parental Lock	45
Operating from the Front Panel	46
Exceptional Case Operation	46
Installation	47
Network Configuration	47
Entering the Network Name	48
Deleting a Network	48
Antenna Alignment	49
Automatic Network Search	50
Manual Search	51
Setting the System Parameters	52
System Parameter	53
Parental Lock	53
System Information	53
Local Time/Timer	53
Daylight Savings Time	53
TV Type	53
Picture Format	54
Screen	54
A/V Mode	54
Factory Setting	54
DVD and Video Recorder Connection	55
Recording	55
Replay	55
Software and Channel List Update	56
Technical Features	58
Technical Data	59
Accessory	60
Scart Socket Seizure	60
VHS/S-VHS Changeover	60
Connection Example	61
Small Technical Encyclopaedia	62
Glossary	63
Service	64

Safety Instructions

This page contains important information about the operation, installation location and connection of the unit.

Read these instructions carefully before starting to use the unit.



DANGER!

Mains cable

Make sure that the mains cable (power supply cable) is not damaged. Units with a damaged mains cable must be disconnected from the mains (disconnect mains connector) and repaired by a qualified engineer before setup. Only use the power pack supplied (if available).

Risk of death due to electric shock.

Cleaning

Disconnect the mains connector before cleaning the unit. Only use a dry cloth for cleaning and only clean the outer surface. Never open the unit.

Touching the parts inside the unit carries a risk of death due to electric shock.

Playing children

Make sure that children do not push any objects into the ventilation slots.

Risk of death due to electric shock.



WARNING!

Earth connection

The antenna system must be earthed as specified or equipotentially bonded. EN 60728/11 and any national regulations must be complied with.

Danger due to surge voltages, lightning strikes.

Mains voltage

Only operate the unit with the specified mains voltage (marked on the rear of the unit or on the external power pack). The unit may only be connected to the mains and turned on once it has been connected to the antenna and to the TV set or the cable network and PC.

If the mains voltage is too high, there is a risk of fire.

Repairs

Ensure that any repairs to your unit are carried out by qualified personnel. Opening the unit and attempting to repair it yourself voids all warranty claims.

Improper work on the unit can jeopardise the electrical safety of the unit.

The manufacturer accepts no liability for accidents caused by the user opening the unit.



CAUTION!

Connections

Incorrect wiring of the connections can lead to malfunctions or defects on the unit.

Long periods of absence / storms

Always turn off the unit at the mains switch if you will be absent for a long time or there is a storm. If your unit does not have a mains switch, you can disconnect it from the mains by unplugging the mains connector. This also applies to the other equipment connected to the unit. Isolation from the cable network is also recommended. Note any timer programs (receiver) and turn the unit on again promptly before the recording time.



Installation location

All electronic equipment generates heat. However, the heating of this unit lies within the permissible range. Sensitive furniture surfaces and veneers may become discoloured by the effects of constant heat over time. The feet of the unit can also cause colour changes to treated furniture surfaces. If necessary, place the unit on a suitable stable and flat base.



Ventilation

The heat generated in this unit is adequately dissipated. However, the unit should never be installed in a cupboard or on shelves with inadequate ventilation. Never cover the cooling slots on the unit (e.g. with other equipment, magazines, tablecloths or curtains).

Do not place any objects on top of the unit and maintain a clearance of at least 10 cm above the unit, so that the heat generated can be dissipated with no obstructions.

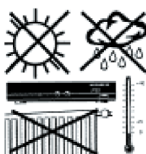













Moisture, sunlight, heat

Protect the unit against moisture, dripping and splashed water (do not place any filled objects such as vases on top of the unit). Do not place the unit close to a heater or expose it to direct sunlight and do not operate it in damp locations. Only use the unit in a moderate climate, not in tropical conditions.

Installation

- First of all, connect your receiver to the TV set and the antenna installation.
- Switch on the TV set.
- Select the AV programme position for the receiver connection.
- **Now** connect the receiver to the wall outlet.
- Switch on the receiver by pressing the red  key on the remote control (stand-by). The following is displayed on the screen:



- Use the   keys to scroll the selection cursor to the line 'Language' and select the desired language with the keys  . Confirm your entry with .
- Use the   keys to scroll the selection cursor to the line 'Active Antenna' and select the desired setting with the keys  . Confirm your entry with  (see pages 15 and 17).
- Use the   keys to scroll the selection cursor to the line 'Start Search'. Confirm your entry with .

We recommend you had the entries now saved by the receiver.

Now, a search is carried out and the receiver is in the basic setting.

The on-screen display informs you on the next steps.

The first programme of the channel list is displayed on the screen, below, a bar is displayed, informing on the programme provider, time, timer settings, programme status and programme name, provided that this information is broadcast by the programme provider. The LED indicates the programme memory number.

The reception status last set will be called up each time you switch on the receiver!

If 'bad or no signal' is displayed on the screen together with the programme last received, check whether the installation is in order and the settings of the receiver are correct. If only a few programmes are affected, this may mean a signal failure on the part of the programme provider.

Please check the time as to daylight savings time and wintertime!



Installation

Factory Setting of the Receiver

Reset your receiver to the basic settings by calling up factory settings in the menu.

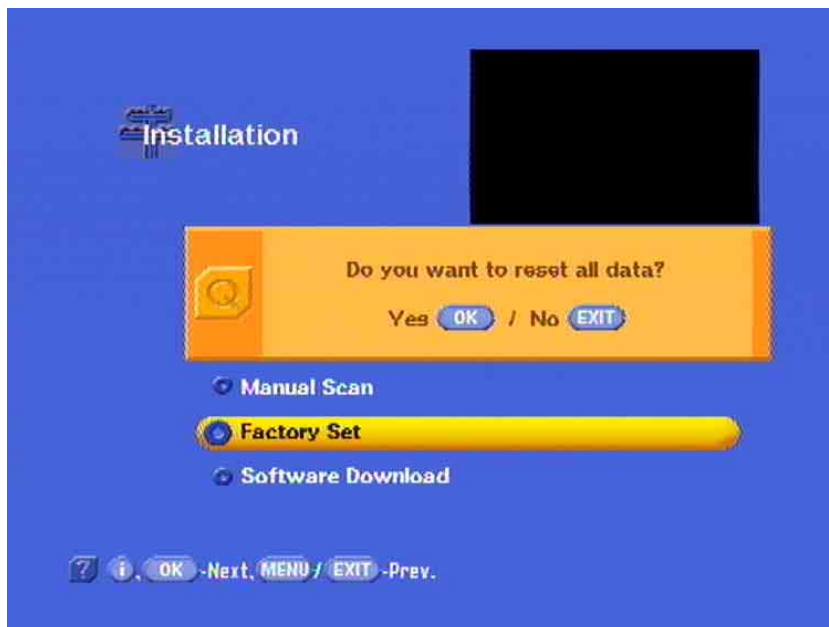

Press **MENU** to call up the main menu. Press **▲▼** and **OK** for 'Installation' and **▲▼** and **OK** for factory settings.

After you have pressed **OK**, the same procedure as specified above in chapter 'installation' starts.

Control Elements, Indications and Connections

Find a brief description of all the control elements, indications and connections of the receiver in this chapter.

The key symbols shown here are also dealt with in the description of the operation steps.

View Front Panel

(flap down)

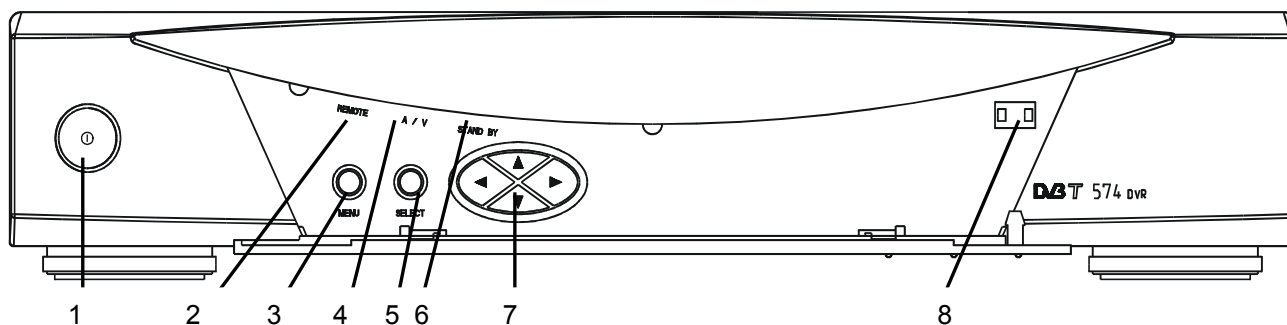

View Back Panel

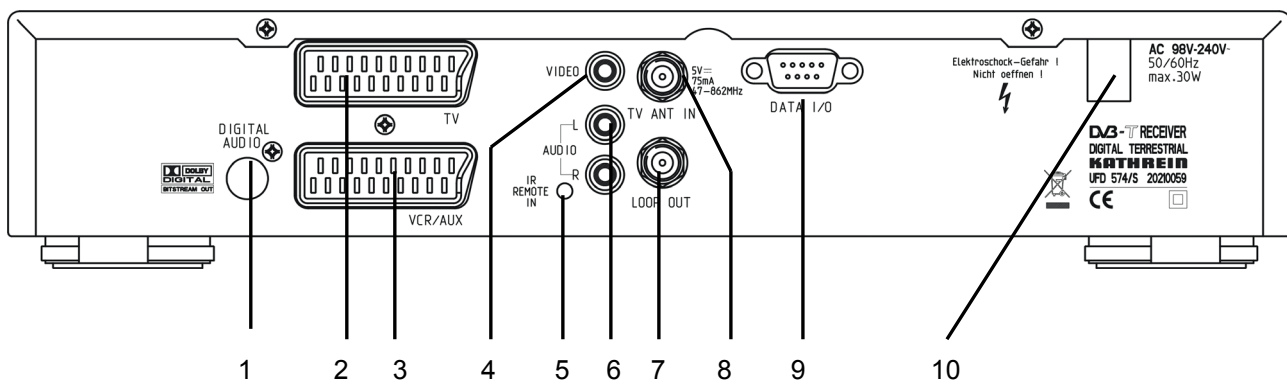

Control elements and indications on the front panel

- 1 On/Off switch (with power disconnection)
- 2 Orange LED – confirmation of the commands via the remote control
- 3 Menu key – equal to remote control
- 4 Green LED
- 5 Select key for calling up the channel list
- 6 Red LED – Stand-by
- 7 Cursor keys – equal to remote control
- 8 Pressure lock for front flap – slightly press on the right upper side to open it



Control elements and connections on the back panel

- 1 Electrical Dolby Digital output (AC 3)
- 2 Scart socket /TV connection
- 3 Scart socket /VCR connection
- 4 Composite colour video output
- 5 Input for infra-red receptor*)
- 6 Audio-outputs
2 Cinch sockets, left and right channel
- 7 Antenna output (looped through)
- 8 Antenna input
- 9 DATA socket – interface for serial data transfer (service)
- 10 Power feed cable

*) An external IR mouse for the hidden placing of the receiver is additionally available

Remote Control/Menu Functions

 Sound on/off

 ... 
Digit input for
programmes, timer etc.



Menu

Last Programme; prog.
is made a favourite

Channel locking

Volume



Exit menu

Fast rewind

Play contents on hard
disk

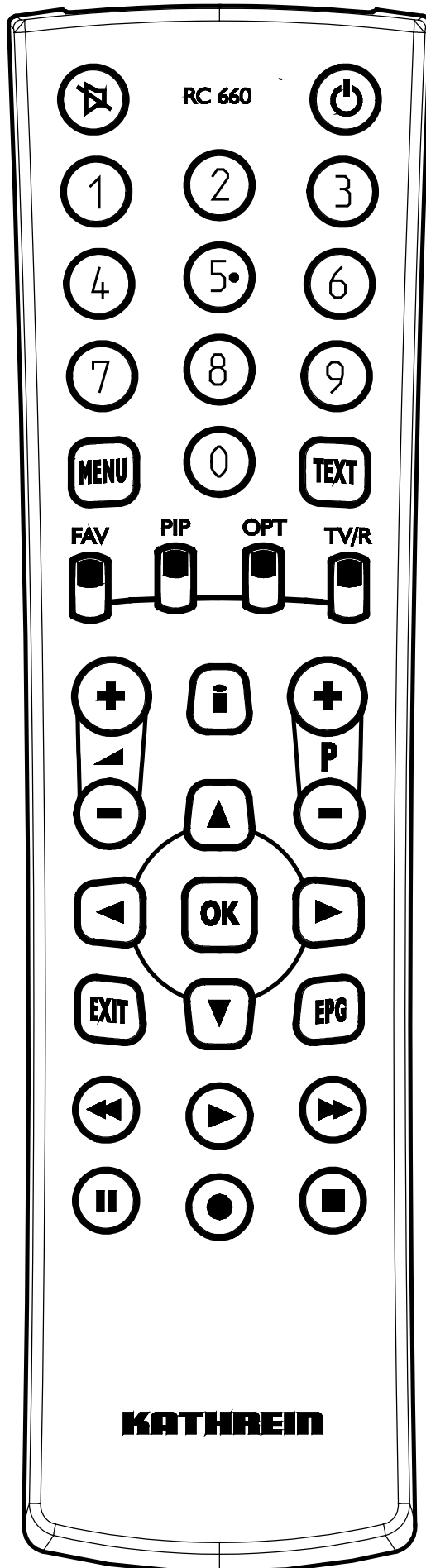

Freeze image Video
Timeshift

Record
Slow motion on play



 On/stand-by

Videotext

Sound selection



Changeover TV/(Radio)

Programme information

 AV mode

programme selection
up/down

Entry confirmation

Cursor keys

Elect. programme guide

Fast forward

Stop record/
Stop play
Freeze image TV

Remote Control/Menu Functions

RC 660 Remote Control

The RC 660 remote control is suitable for up to four different devices and additionally for all UFD 5xx receivers (apart from UFD 552, 554, 558) and all UFD 4xx receivers.



Each keypress on the remote control is acknowledged with the green LED on the front panel of the receiver.

How to have the same infra-red code for each receiver:

Only switch on the corresponding receiver.

Press the following keys on the remote control at the same time

Address 1 = **EXIT** + **9** + **1**

to

Address 4 = **EXIT** + **9** + **4**

EXIT + **FAV** (red) = Kathrein UFD 5xx code RC 400 remote control

RC 600 and RC 650 remote controls cannot be replaced!

Alphanumerical Assignment of Number Keys on the Remote Control

Taste	1 x	2 x	3 x	4 x	5x
①	1	.	,	?	1
②	2	A	B	C	2
③	3	D	E	F	3
④	4	G	H	I	4
⑤	5	J	K	L	5
⑥	6	M	N	O	6
⑦	7	P	R	S	7
⑧	8	T	U	V	8
⑨	9	W	X	Y	Z
⑩	0	empty	0	empty	0

Notes regarding Operation

Language Selection

Select the language of the screen inserts like this:

MENU → ▲ ▼ → menu language → ◀ ▶ → German → OK → EXIT

Select between German, English, Italian, French, Dutch, Portuguese, Spanish and Turkish.

Menu Concept

The menu concept follows logical operation sequences.

The current channel is always indicated in the top right corner of the screen.

Note:

The menus called up, the sub-menus, the positions as well as the parameters to set are highlighted in colours. The menus are self-explanatory to a large extent.



Press MENU to call up the main menu, call up the corresponding sub-menu by pressing ▲ ▼ and OK.

The positions in the sub-menus are called up by pressing the ▲ ▼ keys.

The settings in the positions are effected either with the ◀ ▶ keys or the number keys. Press either MENU or EXIT to exit the main menu and the sub-menus.

Alphanumerical Entries

Use the number keys for entering programme and network names. They create figures and letters in the name fields of the corresponding menus. Scroll the selection cursor to the name field. The first position is automatically highlighted in dark grey. Now you can enter letters in addition to figures by pressing the respective number key several times. This means that A, B and C, e. g., are assigned to key '2' (see photo)

Connection and Initiation

This paragraph is intended for the specialised dealer. You only need to observe it if you install the receiver yourself.

Find an exemplar configuration in chapter 'connection example'.

Do not connect the receiver to the wall outlet before all installation-work has been carried out. In this connection, please observe chapter 'safety instructions'.

Antenna Connection

DVB-T has been developed to allow for good TV reception everywhere an adequate signal can be received. 'Ghosts' are a thing of the past.

Connect the receiver either to your conventional house distribution or community antenna net with which you receive all VHF/UHF signals, or use one of Kathrein's special DVB-T indoor antennae for the reception of the TV signals direct in your living quarters.

Even DVB-T cannot work wonders – a strong reception signal is required. Consequently, problems may arise in concrete buildings if you merely use an ordinary indoor antenna.



Presetting of the receiving Antenna



TV/VCR/AUX Connection

If you (have to) use an active antenna, i. e. an antenna with pre-amplifier, you can energise this antenna via the antenna input of the receiver. 'OFF' is preset to avoid any damage. The use of an antenna suitable for 5 V supply voltage is imperative (see page 17).

Connect the receiver (TV Scart socket) to the TV set with a Scart cable.

If you have a stereo-TV set, you can receive stereo sound via the Scart connection.

Use a Scart cable to connect either a video recorder or a DVD recorder to the VCR/AUX socket.

Audio Connection

For sound reproduction via the HiFi unit, connect the audio Cinch sockets to the input sockets of the HiFi unit with an appropriate cable.

Dolby Connection

The electrical Dolby-Digital data stream output (AC 3) is solely provided for connecting a Dolby-Digital unit.

Putting Batteries in the Remote Control

Remove the lid of the battery case on the back side of the remote control.

Put the batteries enclosed in the remote control. Mind their correct polarity. It is indicated in the battery case.

Insert the lid in the sliding ledge and slide it on until it snaps in.

Used batteries are hazardous waste!

Never throw out used batteries, as hazardous substances do not belong in domestic waste!

Turn the batteries in a collecting point for used batteries!



Electronic equipment is *not household waste* - in accordance with directive 2002/96/EC OF THE EUROPEAN PARLIAMENT AND THE COUNCIL of 27th January 2003 on used electrical and electronic equipment, it must be disposed of properly.

At the end of its service life, take this unit for disposal at a relevant official collection point.

Initiation

The first Steps

- Make sure that you connected everything correctly
- Connect the receiver to the wall outlet
- Switch on the receiver by pressing the power switch on the front panel











The red LED and the figures on the front panel start flashing. The receiver is now in stand-by mode.

Press  on the remote control to switch the receiver to operational mode.

A programme position is displayed after the receiver is switched to operational mode.

Initiation

Initiation with BZD 30 indoor Antenna

1. Switch on both the TV set and the receiver.
 - Press  (**Stand-by**) on the remote control to switch the receiver to operational mode (LED flashes green).
2. Switch the TV set to AV mode, unless it switches automatically.
3. In order to activate the voltage supply of the antenna, carry out the following steps with the remote control of the receiver:
 - Press  to enter the main menu.
 - Select the sub-menu 'installation' with   and confirm your entry with .
 - Now select 'net. configuration' with  . Press  to confirm your entry.
 - Press  once again to call up 'operation'
 - Now change the selection for the supply voltage from 'OFF' to 'ON' by pressing   (see photo).

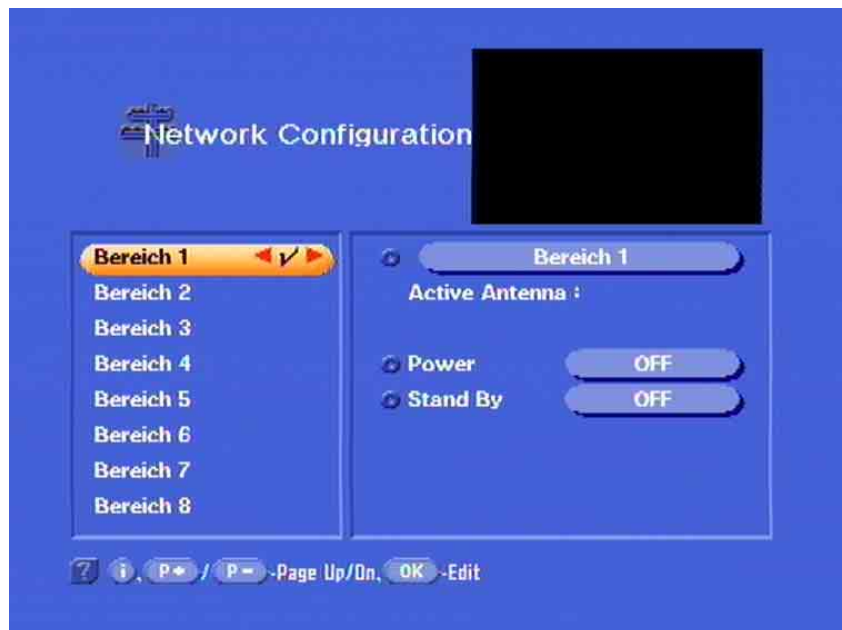

- Now the antenna is energised with 5 V.
- Press  four times to get back to the TV mode.

On-Screen Display OSD

Important Information displayed on the Screen

The receiver functions are controlled by a micro-processor and by extensive software. The following explanations will help you understand all procedures and prevent errors.

By pressing **i** in the individual OSD's, you will obtain detailed information on the further procedure.

Help Function

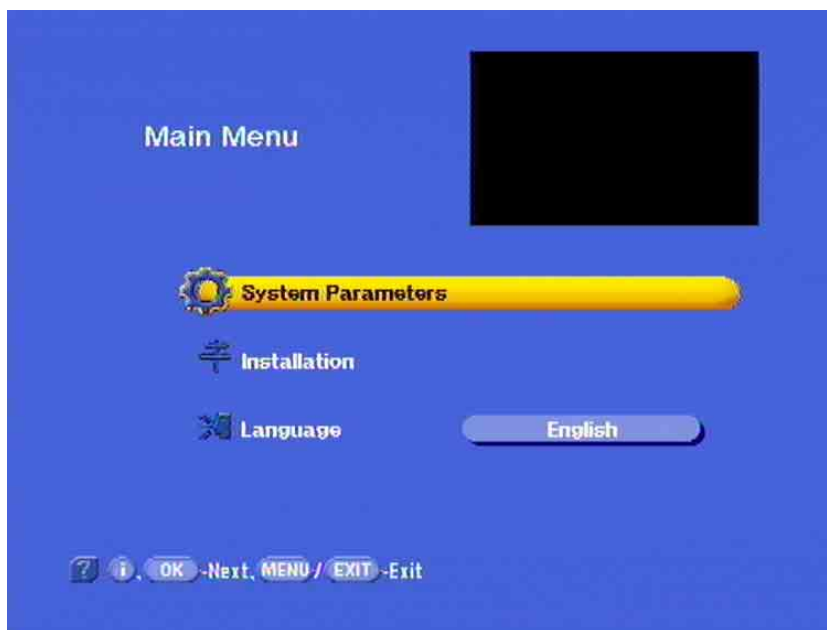

You can call up the help function for every menu item and every menu function. This help function provides a brief description of the most important functions in the menu items called up.

Example: Press **MENU** to call up the main menu.

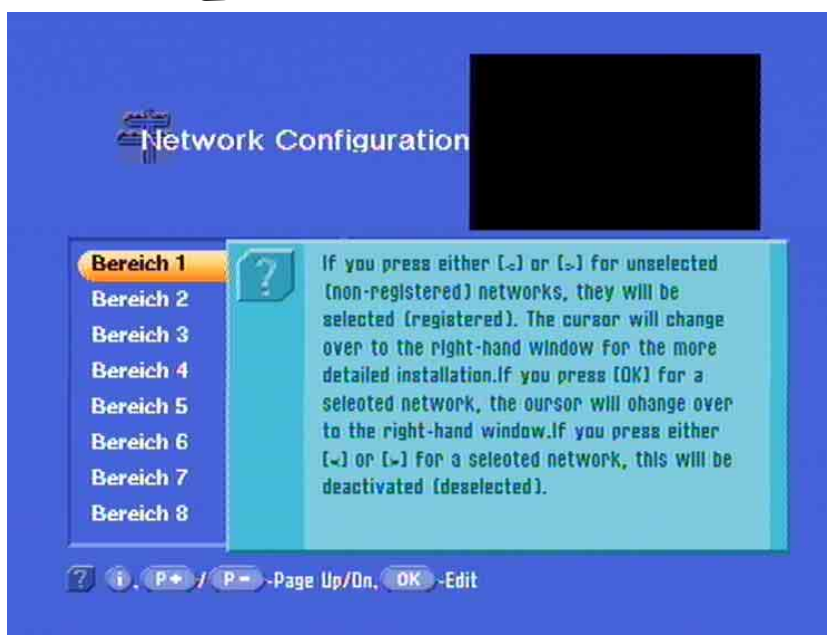

Now press **i** for the help function in the menu item 'system parameter'.

Find detailed descriptions of the menu functions called up in each corresponding chapter of this manual.

On-Screen Display OSD

Press **EXIT** to exit the help function and to get back to the main menu.
Get back to the current programme by pressing **EXIT** once more.

Channel Confirmation TV



The channel confirmation is displayed for several seconds every time you change channels or every time you press **OK**. The 'antenna' icon in the top left corner indicates the reception of a programme even though no picture can be seen (e. g. radio). The 'TV' icon indicates a TV channel, along with it the current programme, the reception of videotext (if so) and the time are displayed. The icon '+' in the third line indicates the programme selection from the overall programme list. If the favourite list is called up, the 'apple' icon is displayed instead, followed by the programme title and the starting time and the end of the current programme, provided that this information is broadcast by the programme provider.

Problem Report



'Bad or no signal' indicates a problem in the receiving installation or in the receiver settings respectively, or a non-transmitting transponder. Check the antenna connection and the antenna configuration. Use the service-settings list on the last pages of this manual for support.

On-Screen Display OSD

Channel List TV





Press **OK** to have the channel list displayed. Find the icon '+' for the overall list in the top left corner. Find indications of the channel, the programme provider and the information whether the programme is scrambled or not in the column underneath. The specifications to the programme received, the net and its channel are displayed in the right upper column. You can select the desired programme either with the selection cursor or by numeric character entry with the number keys. Confirm your entry by pressing **OK**.

Find the menu item 'programme/channel settings' in the right bottom corner. The programme/channel factory settings can be changed there. Press

FAV
 (red/FAV) to make the displayed channel a favourite channel.

PIP
 (green/PIP) to lock the displayed channel.

OPT
 (yellow/OPT) to relocate the channel to another position.

TV/R
 (blue/TV/R) to delete the displayed channel.

+ to add another channel.

|| to select the programme mode of the channel list.

Find further information in chapter 'programme selection'.

Videotext/Subtitles

Videotext

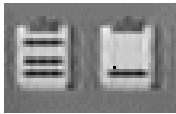

As soon as the 'videotext/subtitle' icons opposite appear, the receiver starts processing these signals –videotext also if signals are scrambled- for the TV set. Call up videotext by pressing the blue **TEXT** key and have it displayed immediately. Exit videotext by pressing the same key.

The individual pages can be called up with the number keys.

While a page is searched, a blinking asterisk appears in the left upper corner.



Subtitles

If subtitles are broadcast, you can call them up with the yellow **OPT** key and with **OK**. Press **◀▶** to select the desired language of the subtitles. Exit the menu by pressing **EXIT**.

Programme Selection

Learn how to change TV channels and how to adjust the volume.



Concerning the function description, we assume that the receiver has been properly connected.

If you wish to connect it yourself, please read chapter 'connection and initiation' first.

Selecting a TV Programme

Reception Status

Below you can learn how to select/call up more programmes and what the screen inserts look like.

Merely press the keys   after you have switched on the receiver to change channels in their ascending or descending order in the programme memory.

The selected programme with the current time, the videotext icon (if available), the starting and end of the programme and the programme title are displayed in screen inserts after every keypress, but merely if this information is broadcast by the programme provider.

By pressing , you can have this information permanently displayed, and you can blank it by pressing the key once more.



If a programme is scrambled, the information 'scrambled programme' is displayed.

Receiving such programmes is not possible with the UFD 574 receiver.

Programme Selection



Alternatively, you can change channel by pressing **OK**. Then, the TV programme list is displayed. You can obtain information on the net, the channel, the carrier number and the programme on the right upper column. The column on the left indicates the programme position, the programme name, the kind of the received signal (FTA/scrambled) as well as the favourites and locked channels.

Press **▲▼** to change to the programme next on the list, press **◀▶** to get to the next page of the list. Select a programme by pressing **OK**.

You can also select a programme by numeric character entry with the number keys.

Press **EXIT** to exit the channel list but retain the current programme.

Programme Selection

Selecting a TV Programm with the Number Keys (numeric character entry)

You can also change channels by entering the programme position of another channel with the number keys ① to ⑩.

Example

You wish to select channel „XYZ“ on position 15 (the TV channel order is predefined in the programme list and therefore only exemplified now).

Successively press ① and ⑤. The receiver takes about 3 seconds to process your entry.

Follow the same procedure for all other programmes, also for those stored on a 3 digit position. Do not enter '0' as first figure, as so-called leading zeros are reserved for the Scart-changeover.

Switching to Radio Channel Reception



Currently no radio programmes are being broadcast on the radio channels. However, this may change in future. Then you will be able

to change over from TV to radio with the  TV/(Radio) key. Operation will be carried out along the same lines of TV operation.

Timer Settings

You can programme a timer to be able to timely record a programme. 14 timers are available, which you can set to different channels as well as starting times and ends of programmes.

Call up the timer settings by pressing **MENU**, then use the keys **▲▼** to scroll the selection cursor to 'system parameters', now press **OK** and use the keys **▲▼** to scroll to local time/timer and confirm with **OK**. The following is now displayed:

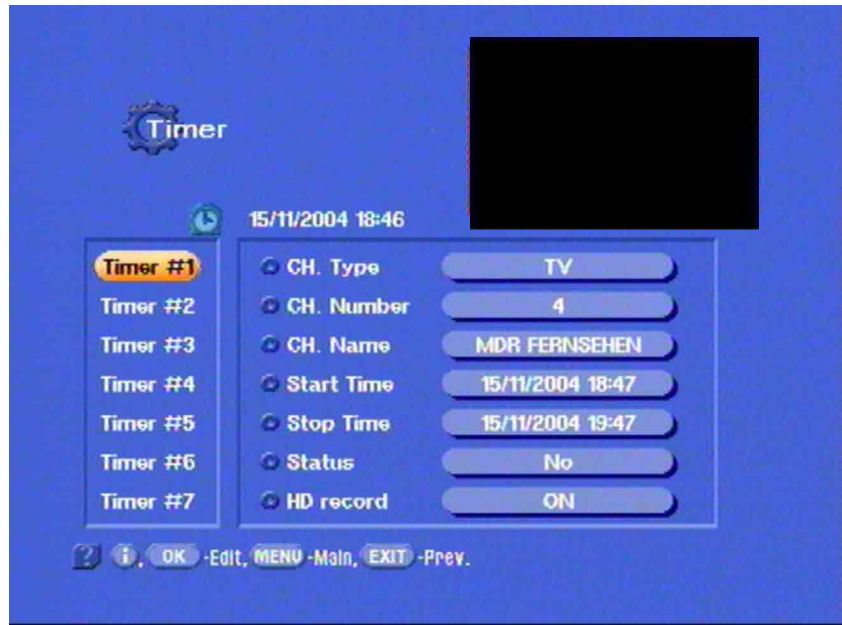

Use the keys **▲▼** to scroll the selection cursor to the appropriate timer and confirm your selection with **OK**. Press **EXIT** to exit the timer again.

Incorrect time settings are rejected.

You can select and set

- the kind of programme (TV, radio or On Air Download)
- the programme position with the programme name
- the starting time (day, month, year, hour, minute)
- the end of the programme
- the timer status no/once/daily/weekly

for 14 timers. Leading zeros must imperatively be entered for the time settings.

Carry out each setting with the keys **◀▶** or **▶** and the number keys.

As the current time automatically appears when the starting time of the programme you wish to record is to be entered, you have to re-enter the correct starting time. Unless otherwise entered, the recording is automatically finished one hour after the start of the recording on the same day.

Timer Settings



Confirm your settings by pressing **EXIT** three times.

If you have timer-preprogrammed a download, all succeeding timer settings are ignored after successful download .

VPS Signal



Please note that signals of digital television do not provide the VPS signal.

Consequently, you have to programme your external DVD or video recorder in accordance with the timer settings.

Sound Settings

Adjusting the Volume











Press  on the remote control of the receiver to adjust the desired volume. A bar indicating the volume is displayed on the screen.

Stereo and Dual-Channel Sound Reproduction

The sound reproduction setting is shown in the channel information, which can be called up by pressing  (depending on where the 'sound wave' icon appears – underneath the displayed time- mono left, mono right or stereo can be set, the figure indicates which is set). The programme title is displayed in the small box on the right.



Press the yellow  key to call up the audio menu for the sound and language selection. You can make the desired settings if the corresponding data are provided in the reception signal, as are e.g. language selection (sound track), Dolby Digital (5.1 CH). Select the menu items by pressing  , and make the desired settings with  . Press  again to exit the menu.

If subtitles are broadcast, you can select the language with   in the bar 'subtitle track'. Confirm your entry by pressing .

AC 3



The receiver has an audio output for the AC 3 format. This means you can enjoy cinema-like sound quality in your living room with the appropriate equipment. Connect the digital audio output only to a suitable HiFi unit.

Please observe the owner manual of your Dolby Digital unit.

In order to have the AC 3 format reproduced, make the following settings: Call up the audio menu, scroll to position 'stereo', set the receiver to '1 of 2' or '2 of 2' respectively (2 CH). Now, 'Dolby Digital/AC 3' is displayed in position 'digital output' – if broadcast correspondingly.

Only a few programme providers broadcast the AC 3 format. If no AC 3 signal can be received, you can merely make the standard mono/stereo settings or select a language which is broadcast.

Sound Settings

Mute Function

Press  on the remote control. The sound is then muted. The same icon is then displayed on the screen.

Press this key again. The sound is now unmuted again. To indicate this, the volume bar is displayed for a few seconds.

You can change channel while the mute function is active, however, this function is retained until the sound is either unmuted again or until you re-adjust the volume with the corresponding keys on the remote control.

Channel List

The initial programme/channel settings can be changed in menu item 'channel list'. Call up this menu item with the keys **OK**, **▲**, **▼** as well as **◀▶** for TV or RADIO and **OK** again. If stored, also a password must be entered.

Selecting the Channel last received



Press the red **FAV** key to have the four programmes last received (for at least 10 sec.) shown on the screen. The arrows displayed accord the cursor keys **▲**, **▼**, **◀**, **▶**. Use these keys to select the respectively assigned programmes. If you call up this function, the flash above appears on the screen.

Favourite Programmes

You can organise and sort your favourite TV and radio programmes, e. g. all German programmes. These favourites are distinguished with the 'apple' icon (shown with the **FAV** key in the 'TV or radio channel list').





Press **◀▶** and **▲▼** to select the desired favourite programme, which is then highlighted with a coloured bar.

Channel List

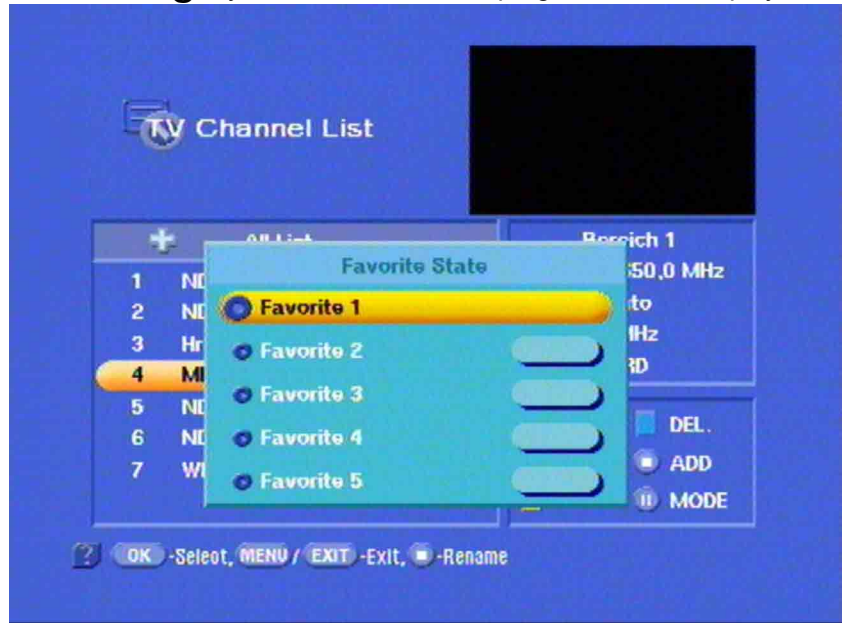
Press the red  key to have the favourite programmes list displayed .



Use the   keys to determine in favourite list 1 to 5 in which list you wish to have your favourite programme stored. You can store several different programmes in one list.

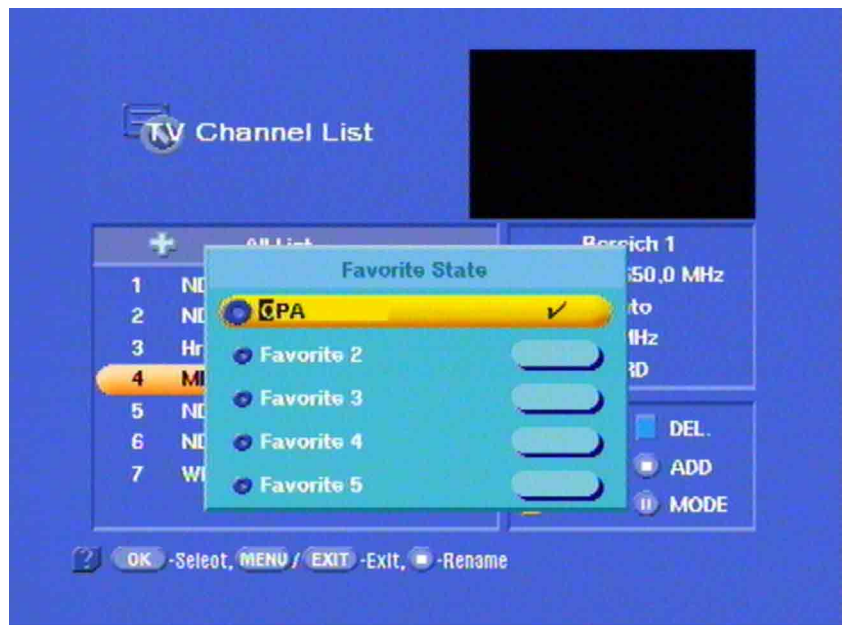

All family members can store their own favourite lists. These programmes can be protected with passwords so that nobody else can watch them (see chapter 'password'). Each selected list is highlighted with a coloured bar. The selected channel is displayed in the top right corner of the screen.

You can give the individual favourites names and compile e. g. programmes in favourite list 1 which mostly show feature films or sporting reports. You can also enter the users' names (e. g. Tony, Hartmut, granny, granddad). By pressing  you get in the mode 'writing'. The first letter is now marked. Use the number keys to give your favourites new names. How to make numeric character entries is explained in chapter 'notes regarding operation'.

Channel List

Confirm your entries by pressing **OK**. You get back to the channel list.

Press **EXIT** to get back to TV. The storage of your new settings is confirmed and the information on the current programme is displayed on the screen for a few seconds.

Calling up a favourite programme: First press **OK**,

then the red **FAV** key. Now you can select the individual favourite lists with the **▲▼** keys. Confirm your entry with **OK**.

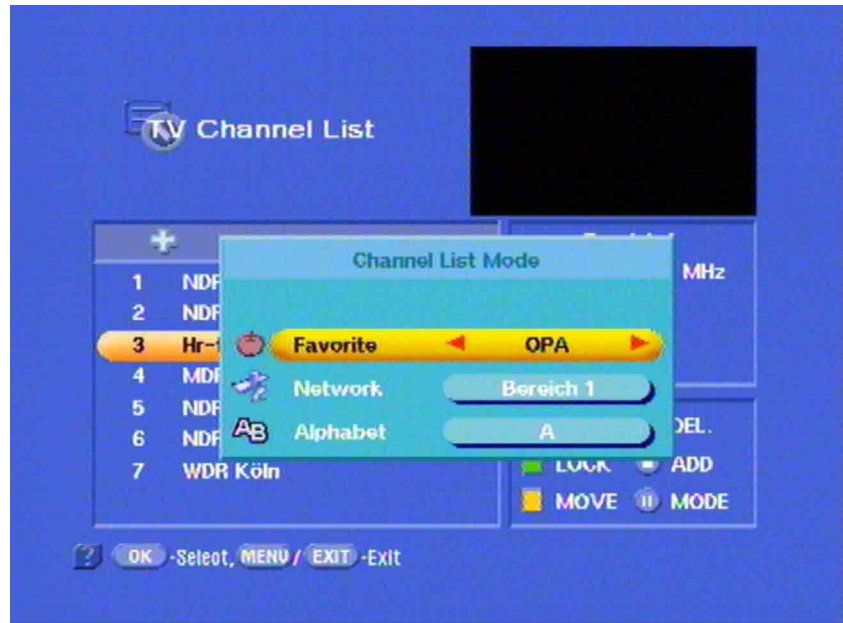

First select the 'apple' icon line with the **▲▼** keys, then the desired list with the **◀▶** keys (in this example: 'granddad'). The desired favourite list is displayed after pressing **OK**.

Channel List



Press **▲▼** to select the desired programme, it is highlighted with a coloured bar and displayed in the right upper corner on the screen. Press **OK** to call up the desired programme. If you wish to cancel one of your favourite list entries, select the corresponding favourite list in which this entry is stored with **▲▼** and **OK**, delete the 'apple' icon by pressing the red **FAV** key and confirm your entry with **OK**.

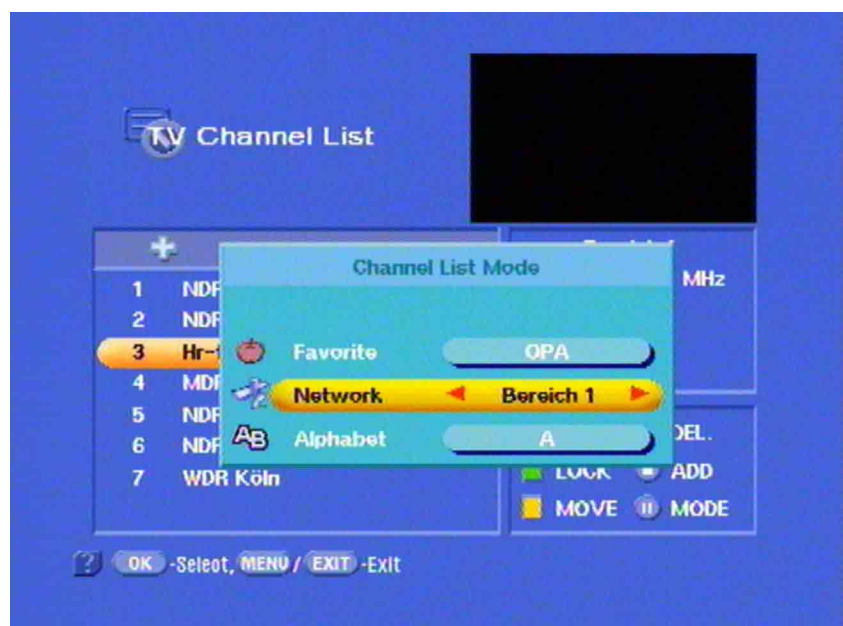

If you want to get back to the channel list (display of all programmes of the networks which are set), press **⏪**, then press **▲▼** to select the 'network line', then select 'all networks' with **◀▶**. Press **OK** to have the current channel list displayed.

Channel List

Alphabetical Channel Search

You can have all the channels with the same initial letters displayed in one list. Consequently, you can very quickly pick out a certain channel from the overall channel list. Press **OK** to call up the channel list.

Press **II** to call up the 'channel list mode'.

Press **▲▼** to select the bar 'alphabet'.



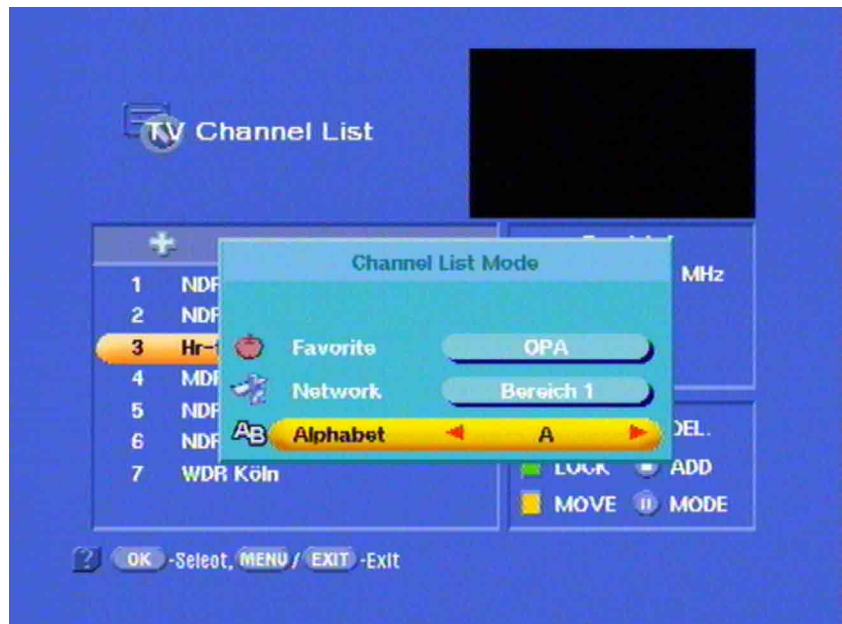

Find the desired letter by pressing **◀▶**. Each letter is shown in the 'alphabet bar'.









Press **OK** when you have found the desired letter. Then all the channels, the names of which start with this letter, are listed and displayed.

Channel List

You can determine the desired channel with the   keys. It is highlighted with a coloured bar and displayed as small insert in the right upper corner of the screen.





Press  to confirm your selection. The programme is now displayed.







If you want to get back to the channel list (display of all programmes of the networks which are set), press , then press   to select the 'network line', then select 'all networks' with  . Press  to have the current channel list displayed.

Channel sort Function

You can sort the channels just as you want. The sorting is effected by shifting the entries in the channel list.

Call up the channel list by pressing .

Select the channel you want to shift with   and  . The bar indicating the current programme is highlighted in the list with a coloured bar and the programme is displayed as insert in the upper corner of the screen.

Press the yellow  key to mark the channel which you want to shift. The writing in the bar is now red. Now you can shift the channel just as you want with   and  . Press the yellow  key once more to position the channel where you want to have it stored.

Press  to leave the channel.

The new storage is confirmed and displayed on the screen for a few seconds. The shifted channel is shown on the screen and now stored on the new position in the channel list.





Deleting Channels



Be careful when deleting channels!

Basically, you need to follow almost the same procedure for deleting a channel as for sorting a channel.

Press  to call up the channel list.

Select the position of the channel you want to delete by pressing   and  .

Now, confirm deleting the channel by pressing the blue  key.

The following question is now displayed on the screen:

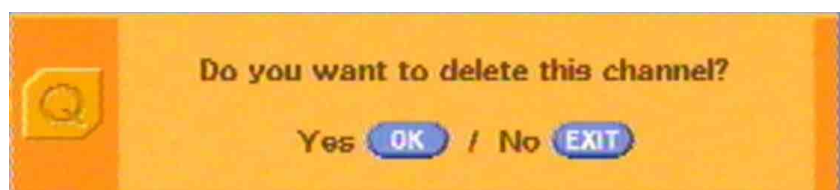

Confirm the desired procedure by pressing the corresponding key (OK/L).

Press  to have the channel deleted. The changes in storage are confirmed and the programme of the next channel on the list is on the screen.

Channel List

Adding channels manually



This function is only necessary for channels which are not broadcast in DVB standard. All channels conforming to standards are recognised and stored in the automatic search.

Basically, you need to follow almost the same procedure for adding a channel as for sorting a channel.

Press **OK** to call up the channel list.

Press **■**, and the menu item 'adding a channel' is displayed on the screen.

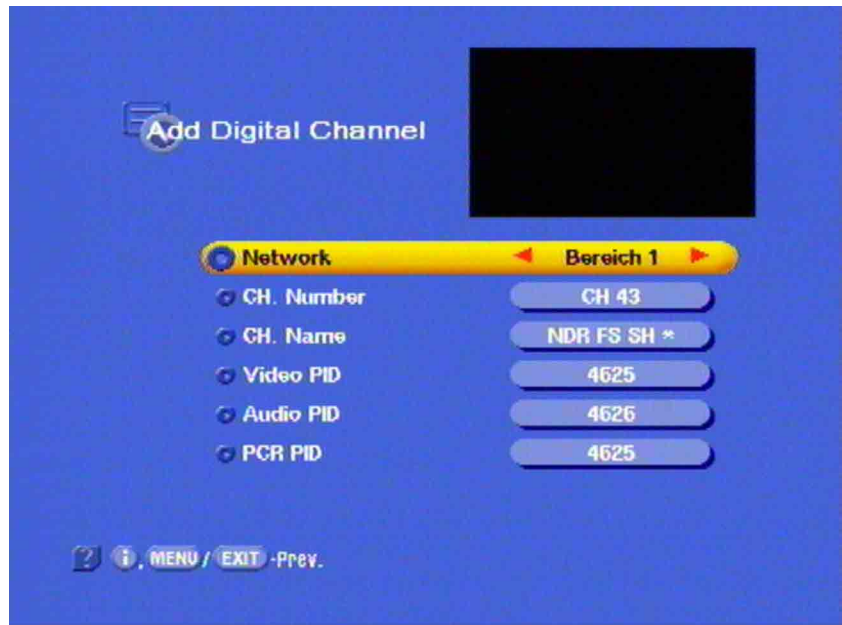

You can make your entries for the new channel here.

The first line in the list is highlighted with a coloured bar.

Press **▲▼** to scroll the bar up or down to the desired position.

Setting the respective position, that is to say the respective entry is effected with the **◀▶** keys and the number keys.

- Each network received
- the channel
- the channel name

can be set.

On the positions

- Video PID (Programme Identification),
- Audio PID and
- PCR PID (PCR = Programme Clock Reference)

Only alphanumerical or decimal entries are accepted.

Channel List

Press **OK** to get back to the channel list. The storage of your entries is confirmed and the information on the currently set channel is displayed on the screen for a few seconds. The new channel is added to the channel list.

Find out the necessary PIDs in the relevant magazines and on the internet among others. Learn how to make alphanumerical entries in chapter 'instructions on operation'.

Never change the PID specifications without cause, as they affect the recognition of the received signal.

Programme Overview

EPG



Press **EPG** to get an overview of the programmes broadcast in the currently received network inclusive the time and the length of the programme, but only if this information is broadcast via the Electronic Programme Guide (EPG), as it is the case with ARD and ZDF. The programme title is told in short form in the column on the right. In the column on the left, you can scroll the cursor (with the **▲▼** keys) to the programme you want to change to with **OK**.

By pressing the green **PIP** key (current/succeeding) you can obtain information on the succeeding programme of the programmes listed.

By pressing the blue **TVR** key (extended) further information on the programme is displayed.

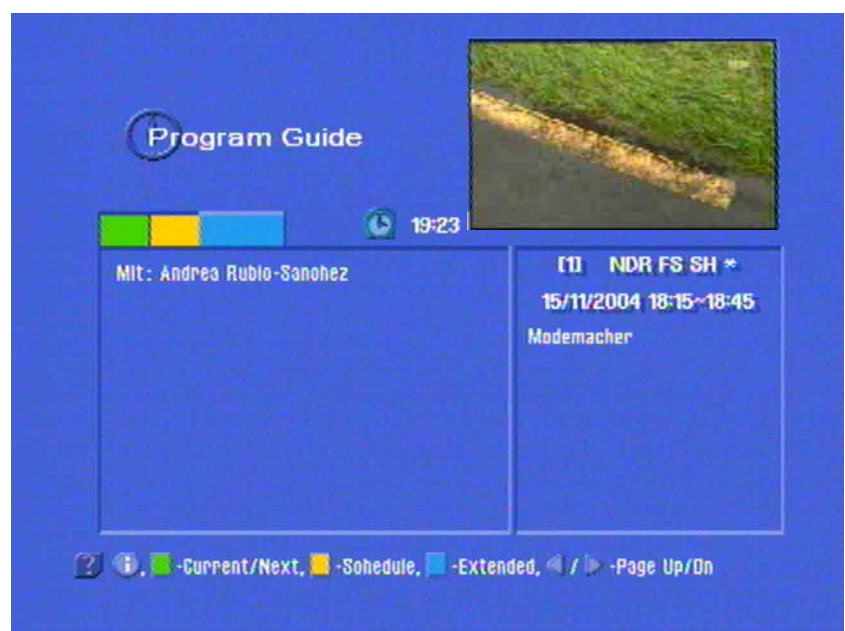

By pressing the yellow **OFF** (list) key, you can obtain information on the programme succession of the currently received channel inclusive time and length of the programmes, but only if this information is broadcast via the Electronic Programme Guide (EPG).

Programme Overview

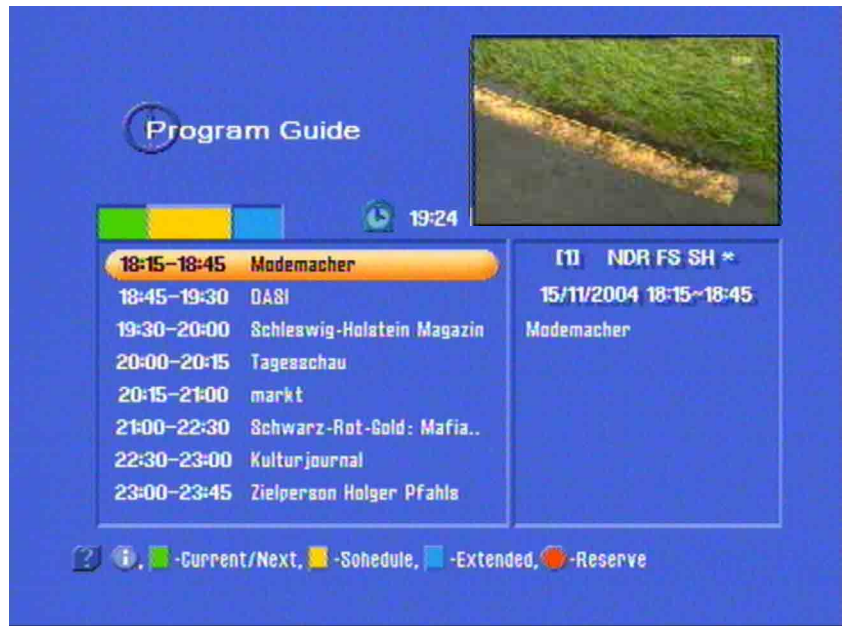

The length of the programme list is dependent on each programme provider and its contents can span several days.

Timer Programming via EPG

You can scroll the coloured bar in the list with and select a programme for timer programming. By pressing the red key (storing), the timer is displayed.

By pressing , you can select different settings, e.g. the programme is to be recorded only once, or daily or weekly.

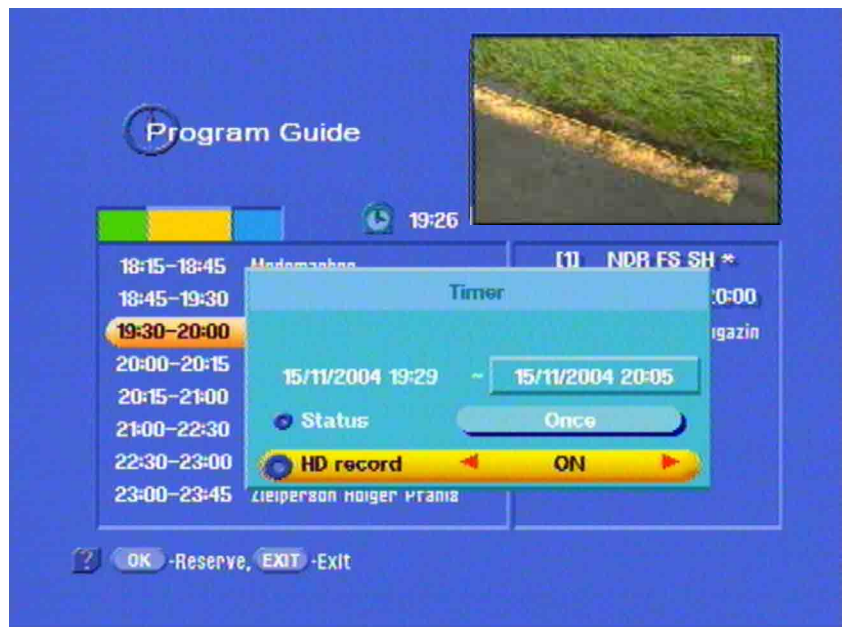

Then you can scroll the coloured bar in the list with and determine by pressing the keys if the programme is to be recorded on the hard disk (selection 'on') or on your external video recorder (selection 'off').



Programme Overview

Press **OK** to confirm your selection. The confirmation is displayed for several seconds. The programme will be recorded on the time set.



Press **EXIT** to exit the timer settings.

Hard Disk Recorder



Your receiver is equipped with a hard disk and therefore allows for the recording of the current programme while watching the same one time delayed, or another earlier recorded programme. The recording capacity is depended on the picture contents of the programmes broadcast.

Mind the information on the next operation steps in the bar at the bottom of the screen insert!

Recording

Hard Disk Capacity

Please check before each recording whether the hard disk still has enough capacity. By pressing , or , the contents on the hard disk (1) as well as the remaining storing capacity (2) are displayed.

Instantly Recording (OTR/One Touch Recording)



You can immediately record the current programme on the hard disk with your DVB-T recorder. To do so, merely press (OTR = One Touch Recording/Instant recording) and confirm with .

Recording Manually

Press and to select a programme and prepare the recording with the red key .

Now a menu is displayed showing the channel name, the programme title (information) – if broadcast - as well as the starting time and the end of the programme. You can vary the name and information and the recording stop with the number keys. Press to vary the recording stop in 30 min steps.

Press to start the recording.

The 'hard disk contents' displayed now for a few seconds show a red 'R' for Record in the right upper corner of the screen, and display the title of the current programme in the small box at the bottom. For a few seconds, the LED indicates 'REC' (Record) and 'HXXX', the record

Hard Disk Recorder

number, during recording. Additionally, the red light-emitting diode (stand-by) on the front panel flashes.

The 'hard disk contents' are displayed for about 5 seconds, then the recorded programme is played.

If you want to jump in a current programme at once, you merely have to press either **i** or **OK** and the 'control panel' of the receiver is displayed.



Timer Recording

Please refer to chapter 'timer programming' and to EPG timer in 'programme overview' for timer recordings.

The timer starts the recording on the pre-programmed time. The receiver also feeds the VCR socket with the recording so that you can additionally record the programme on an external recorder at the same time.

All DVR functions are active during the timer recording. So you can start playing the recording in time-shift mode even though the recording has already started before. The recording can only be stopped by pressing **⏻** (stand-by) and **■** - the 'hard disk contents' are displayed - or by pressing **EXIT**.

After the time given by the timer has run out, the receiver automatically switches to stand-by mode.

Note:

Receiving and recording at the same time as well as receiving and the replay of another programme at the same time is not possible!

Stopping the Recording



After the time given by the EPG or set by you has run out, the recording stops automatically. The 'hard disk contents' are displayed.

By pressing **EXIT** you get back to the original programme.

Receiving another programme is not possible while a programme is being recorded on the hard disk.

However, you can stop the recording yourself, too. To do so, press **EXIT** or **■**, the 'hard disk contents' are displayed. By pressing **EXIT** once more, you are asked whether you want to stop the recording, confirm that with **OK**. Then, 'recording stopped' is displayed on the screen and the HD programme overview is retained. The programme recorded as far as that is indicated at the end of the list. Press **EXIT** to have the ordinary TV screen again.

Hard Disk Recorder

Setting and Deleting Indices

During the replay of a recorded programme you can set indices by pressing (⏏). The episode you set between two indices will now be skipped on the next replay (e. g. for films and recordings without advert breaks).

Indices can only completely be deleted in a recording (see screen shot above).

Delayed Replay

You can interrupt a current recording by pressing (⏏) (in the background the recording is continued). Press (▶) to continue the recording just where you stopped it. Press (◀) to rewind the current programme (to search scenes), and have them repeated by pressing (▶). After pressing (⏏), you can continue watching the current programme time delayed.

Audio Mode

The audio modes 'S' (stereo), 'L' (mono left) or 'R' (mono right), Dolby Digital AC 3 or MPEG stereo can be set with the yellow  key and the cursor keys.

Search

Visible Search

You can carry out a visible search in four steps (up to four arrows are displayed) in the regular replay by pressing (◀) and (▶).

In audio recordings this function does not work due to the automatic mute function.

Time-Controlled Search

If the control panel is active, you can carry out a time-controlled search when you have a freeze image displayed on the screen (⏏) by pressing (◀) and (▶).

The longer the the forward/rewind key is kept pressed, the faster the search speed becomes. You can tell this by the bar and by the numerical indication.

Press (▶) to continue the regular replay on the desired position.

Freeze Image

Press (⏏) to have a freeze image where desired. Unlike replays of tape recordings, you can have freeze images as often as you like as they are of unchanging digital quality without any 'wearout'.

Slow Motion

Press the red (⏏) key to slow down the speed of the regular recording in four steps. Each time you press the red key, you halve the slow motion speed. Press (▶) to get back to normal replay speed.

Hard Disk Recorder

Note: The slow motion function does not work when the control panel is displayed.

Breakpoint

You can quit the replay of a recorded film in order to go on watching the current programme by pressing **EXIT** twice. If you want to continue with the recorded film, change to the hard disk mode and call up the film by pressing **OK**. The replay starts just where you interrupted it before, provided that you have neither switched the receiver off nor to stand-by in the meantime.

Stopping

After pressing **STOP** or automatically at the end of the recorded film, the receiver switches back to the 'hard disk contents'. Press **EXIT** to exit the menu and get back to the programme you watched last.

Deleting

In order to delete a recording, let the 'hard disk contents' be displayed by pressing **PLAY**. Use the **UP**/**DOWN** keys to select the recording you want to delete and press the blue **TVR** key. You are now asked whether you really want to delete it and can confirm with **OK** or cancel with **EXIT**.



Recordings are irrepealably deleted!

While recording a programme you cannot delete another recording already stored on the hard disk!

Password



Factory Settings



Password Entry

You can provide your satellite receiver with a password protection against unauthorised access. Thus, the reception settings of the receiver cannot be changed by foreign or unauthorised persons. Also, you can activate the parental lock function which certain programmes can be locked with.



Keep the password in safe custody so that you always have access to your programmes even if you have forgotten the password.

The password '0000' is factory set.

Press  to call up the main menu.

Select the position 'system parameters' by pressing   and confirm with .



Now select position 'parental lock' with the keys   and confirm with . As the case may be, you are asked to enter your password.

Password



You can make the following settings here:

Age limit: This setting is only active if the appropriate lock signals are broadcast.

Locking lists: Yes/No. The edit function for the channel list can be locked and allowed respectively.

Locking installation: Yes/No. Access to the installation menu can be locked and allowed respectively.

New password: Use the number keys to enter your (new) password.

Confirming password: Use the number keys to enter your (new) password once again for confirmation.

Personal: Enter the receiver-ID which the receiver reports when you switch it on. This may serve as an useful help to identify it in case of theft. Refer to paragraph 'instructions on operation' to find out how to use the number keys of the remote control for numeric character entries. The factory setting is 'UFD 574'.

Now you have made all the settings for the protection and the identification of your receiver.

If you have forgotten or lost your password, please contact your local dealer to unlock your receiver.

Password

Parental Lock

The procedure for distinguishing the favourite programmes is similar to the procedure for setting the parental lock in order to avoid children having unauthorised access to certain channels. The locked channels are indicated with the 'padlock' icon in channel lists 'TV' or 'Radio'

Press **OK** to call up the TV channel list.



Use the keys **▲▼** (down) or **◀▶** (page per page) to select the channel you want to lock.

The selected channel is highlighted with a coloured bar.

Press the green **PP** key to confirm the selection, the 'padlock' icon appears in the bar.

You automatically get to the display of the channel next in the list.

Press the green key to lock a further channel or get back to the channel just locked by pressing the cursor keys. The channel will be unlocked again if you press the green key once again. In this case, the 'padlock' icon disappears.

Press **OK** to confirm your changes.

On calling up the locked channel, 'this channel is locked' is displayed and the channel cannot be watched.

On calling up the locked channel, the password is inquired, and you can watch this channel only if you have entered the password.

On calling up the locked channel via the number keys, 'this channel is locked' is displayed and the channel cannot be watched.

Operating from the Front Panel

If you happen to have mislaid your remote control or if the batteries of the remote control are empty, you can also run your receiver from the front panel.

Exceptional Case Operation

These seven keys are on the front panel:

The on/off key and, behind the flap, the menu key and a select key as well as the cursor keys. The latter are used just like the arrow keys on the remote control.

Use the on/off key to switch on or off the receiver.

You can select all channels and menu items as well as adjust the volume with the arrow keys. The select key on the front panel has the same functions as the  key.

As there are no number keys, you cannot call up any password-protected channels.



Installation

Network Configuration



Please mind the supportive information you can read in the individual menu items by pressing **i!**

Of course, new networks can also be added to the network configuration.

Refer to menu item 'antenna alignment' in the installation menu for support in aligning the antenna.

Get to 'network configuration' by pressing **MENU** to call up the main menu, and by using the keys **▲▼** and **OK** (plus password – if activated), scroll to the submenu 'installation'. Select 'network configuration' by pressing **OK**. Now, you can add or select a new network.



Consider that your installation must be set accordingly!

In the next step, e. g. scroll with the keys **▲▼** to a desired entry, 'area 2' or any other.

After pressing **◀** or **▶** the question whether you want to add the network is displayed on the screen.

Confirm by pressing **OK**.

The following is displayed:



You can now use the keys **▲**, **▲** and **◀** or **▶** to make the entries in the respective positions according to your receiving installation.

Press **EXIT** three times to exit the menu while the new station data are being stored.

Under point 'operation', you have to enter whether your active antenna is to be fed by the receiver.

Under point 'stand-by', you have to enter whether the supply voltage is to be disengaged when the receiver is switched to stand-by.

Installation

Entering the Network Name

Scroll the selection cursor to the existent network name (via active antenna:) The first letter is highlighted. You can now change the network name with the number keys. Find out in paragraph 'instructions on operation' how to proceed.

Deleting a Network



Please mind the supportive information you can read in the individual menu items by pressing **[i]**!

In order to delete a network, call up the 'network configuration', scroll the cursor with **[▲]** or **[▼]** and press **[◀]** or **[▶]**. You are now asked whether you want to delete the network. Either confirm with **[OK]** or dismiss with **[EXIT]**.



Installation

Antenna Alignment



Please mind the supportive information you can read in the individual menu items by pressing **i!**

The menu item 'antenna alignment' will come in useful for this procedure.

Here you can see some technical data which are merely intended for the servicing technician. The entries with the network name and the reception channel are significant for you.

Here **'area 1'** and **'CH 43'**.

If you have already been receiving a signal, you will be able to see to bars in the left column indicating the level and the quality of the received signal.

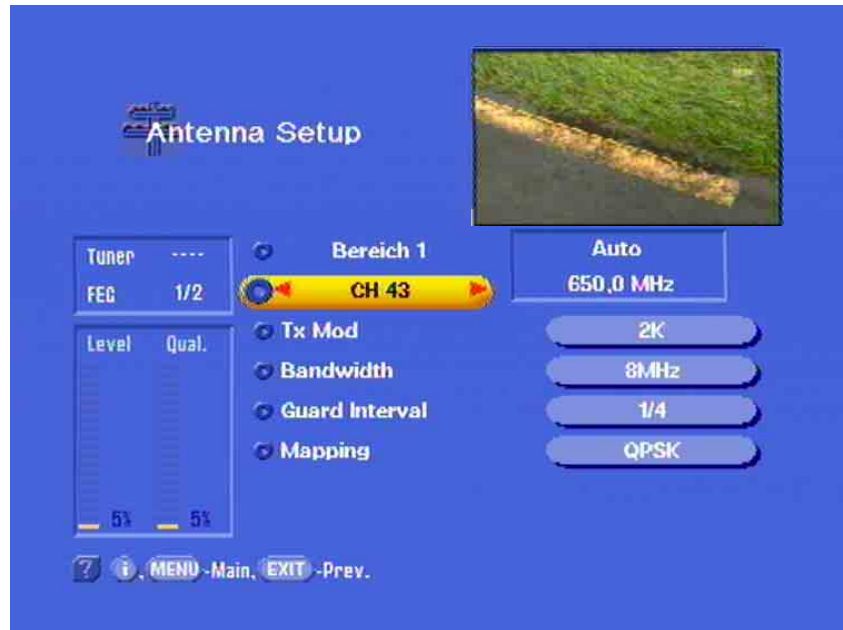

You can now change the antenna location or, if it is a directive antenna, slowly pivot it.

On doing so, observe the maximum of the left bar before fixing the antenna in an appropriate way.

Installation

Automatical Network Search

You can have your receiver automatically search networks and channels. You can select either 'network' search or 'channel list' search.

Channel list: Receiver searches existent channels by means of the channel list.

Network: Receiver searches all the channels available in the current network.

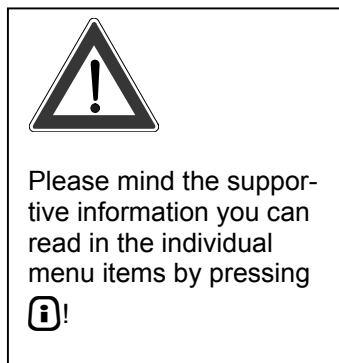

Press  to start the automatical search.

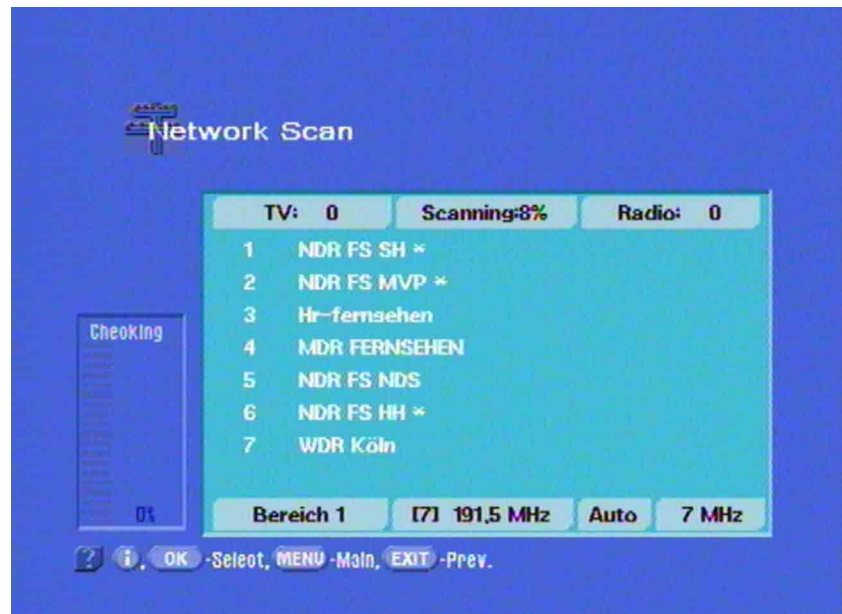

The scan progress is indicated with 'Scanning: --%' .



Which channels are currently stored is indicated in the TV list and the radio list. When the end of the search is indicated, you simply have to store the result and exit the menu by pressing  twice. The new data are stored automatically.

Installation

Manual Search



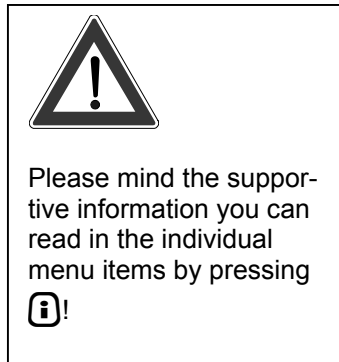

We recommend the manual search if you already know the channel data, the frequencies or the channel number. Use the   keys to scroll to one of the two settings that you can change stepwise until you receive a signal. The bar on the left will help.

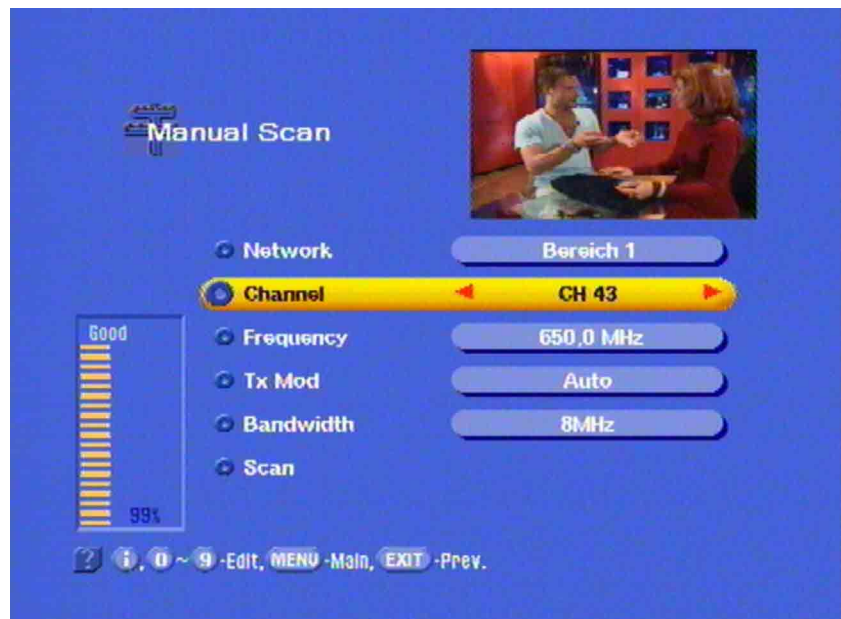

Picture above: Correct network, wrong channel, wrong frequency
Picture below: Correct network, correct channel, correct frequency, Signal display: 'Good'



You have to enter network, channel and frequency as otherwise the manual search cannot be carried out.

Channel input: Select the respective channel with the   keys or with the number keys. To do so, press  and enter the desired channel number. After pressing  once more, the channel with the respective frequency is changed.

Frequency input: This function is only intended for the servicing staff and allows for the manual input of the channel frequency.

Setting the System Parameters

You had better not change the following settings without cause, as they are either factory settings or settings for the operation of the receiver which are syntonised to your receiving installation (or location).

Merely changes in the receiving installation might require new settings.

The menus, submenus and positions called up as well as the parameters to set are each highlighted in colours. The menus are mainly self-explanatory.

You can obtain supporting information on each menu called up by pressing **i**. Exit this help function by pressing **i** once more.



The main menu, which you always call up with **MENU**, includes the following sub-menus:

- System Parameter
- Installation
- (Menu) language

Setting the System Parameters

System Parameter



Select the menu item 'system parameters' with **▲▼** and **OK** in the main menu. Call up the further positions with **▲▼**.

Parental Lock

The basic settings which can be made here are described in chapter 'password', parental lock settings.

System Information

'System information' contains unchangeable factory settings intended only for the servicing staff. Press **EXIT** to get back to the sub-menu 'system parameters'.

Local Time/Timer

The receiver displays the 'UTC' (United Time Coordinate, formerly Greenwich Meantime), which is transmitted in the data stream. This means that the time has to be corrected by +1 hour for Germany.

If necessary, the daylight savings time has to be corrected so that the timers function duly.

You can correct it yourself with the **◀▶** keys by the half-hour. Use the **▲▼**-keys to scroll the selection cursor to local time/timer'. Press **EXIT** twice to confirm your entry. The receiver stores the new setting.

After this setting, do not switch off the receiver with the power switch but with the remote control as otherwise the new settings will be lost.

Daylight Savings Time

You can correct (select) the daylight savings time (yes/no) with the **◀▶** keys.

TV Type

Use the **◀▶** keys to set the type of TV set you have, namely either



- PAL-,

Setting the System Parameters

- Multi-Standard or
- NTSC

Confirm by twice pressing .



Picture Format

Use the   keys to select the picture format your TV set is suitable for, namely either

- 4:3,
- 16:9 or
- Auto

Confirm by twice pressing .



Screen

Use the   keys to set the kind of screen presentation

- Normal (P/S) = normal presentation for 4:3 TV sets or
- Wide (Letter-Box-Display off) – in this setting, the wide picture format for the 16:9 TV set is imposed on.

Confirm by twice pressing .

A/V Mode

Use the   keys to select the type of video signal on the Scart-Socket. Select the signal your TV set can process.

Refer to the manual of your TV set!

- Composite Colour Signal
- RGB – Red /Green /Blue signal or
- Y/C – S-VHS signal (Luminance/Chrominance)

Confirm the selection by twice pressing .

Factory Setting

In this position you can reset all settings to the factory settings by pressing . The factory settings need not necessarily correspond to the settings required for your receiving installation. It may well be that you will have to make all settings once again after a reset.

DVD and Video Recorder Connection

Please refer to the connection-scheme at the end of this manual and to the manual of your video recorder in order to find out how to connect your video recorder to your receiver.

Recording

For a VCR recording, either the satellite receiver has to be switched on or the timers have to be programmed (see paragraph 'timer settings')

Replay

For VCR replay, the satellite receiver has to be switched to stand-by so that the signal path can be connected through the VCR/AUX/Scart socket to the TV Scart socket.

You have to set the Scart socket of the satellite receiver to 'AUX' by pressing **0** so that the TV set can automatically reproduce the pictures of the video recorder.



In this setting, the picture of the video recorder is connected through to the TV set on replay.



If you have set 'SAT' with **0**, the satellite receiver is preferential.

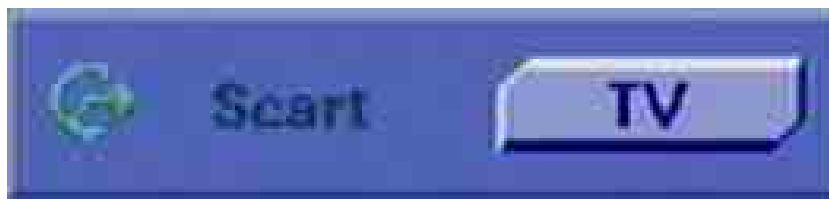

If 'TV' is set, the video signal of the TV set is preferential.

Software and Channel List Update

Due to digital technology, the software and the channel list of your receiver can also be updated via the reception. Refer to the sub-menu 'software download' to find out whether new software or a new channel list is available. Your receiving installation being aligned and set to a service channel is the only precondition.







Select the main menu with **MENU**. Call up the sub-menu 'installation' with **▲▼** and **OK**. Scroll the selection cursor to the position 'software download', and select this position with **OK**.

The menu item 'software download' is thus opened. You can call up the individual positions with **▲▼** and **OK** here. In position 'show information', you can obtain information on the transmitted software and the channel list. The positions 'show information', 'operational software' and 'channel list' are automatically commented on with 'Yes' if new information and contents are available. The left bar indicates the relative signal level.



Software and Channel List Update

Use the bright selection cursor   and  or  to determine which position you want to deactivate (No). The positions which are already inactive cannot be changed. If you merely want to actualise the software but want to leave the channel list, deactivate the field 'channel list' and the other way round.

To carry out an update, scroll the selection cursor to 'Start' and confirm with . Then the receiver starts the update, and, if necessary, displays the following information on the screen:

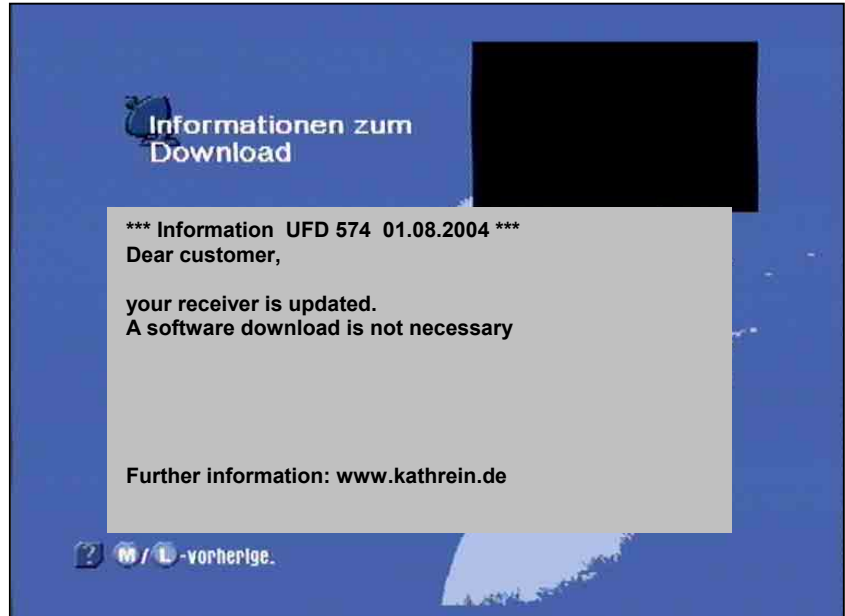

After the update, the receiver is re-initialised and operational again. In case of an error or a missing signal, '**download failed**' is displayed.

Not on any account switch off the receiver during the update as otherwise you will delete the entire software. In this case, the software would have to be re-installed either in a workshop or via PC and null modem cable. During the download '**please wait**' is blinking.

*After the request
'show information'
you should go by the screen insert which is then displayed,*



Observe all screen inserts!

After a software update, you have set the time again!

You can also call up the software updates on the internet under: www.esc-kathrein.de/download/ufd/

You can also find information on this procedure there.

Technical Features

Reception of all DVB-T-TV and radio programmes (Free to Air)
Looped through antenna input
1,000 programme memory positions
Integrated 80 GByte hard disk for up to 56 hrs. recording capacity
Electronic Programme Guide (EPG) spanning several days and brief descriptions of the programmes
Timer programmable for 14 programmes
Timer programming via EPG
Software update for operational software and channel list on air (optionally via antenna) and RS 232 serial interface
Screen inserts/On-Screen-Display (OSD) in 8 languages (German, English, French, Italian, Dutch, Portuguese, Spanish, Turkish)
LED displays for operation, stand-by and RCU reception
Videotext generation (display on TV set via internal receiver)
4:3 and 16:9 format recognition (choice of viewing format)
Composite colour, YC (S-VHS) and RGB signal output programmable via Scart socket
Manual input of PID data
Programme search
2 Scart sockets
Audio output via Cinch sockets
S/PDIF (IEC-958) Dolby Digital audio output (AC 3)
Radio key
Volume adjustment and mute function
Automatical date and time setting via DVB data stream
Programme position sort function
Infra-red remote control
RF level display
External infra-red sensor for hidden placing of the receiver (accessory)
Operation of an active DVB-T indoor antenna (e. g. Kathrein BZD 30) possible without additional power supply unit

Technical Features

Technical Data

RF Features

Frequency ranges VHF	C05 to C12 177.5-226.5 MHz
UHF	C21 to C69 474-858 MHz
Input level range	28 to 98 dB μ V
RF input	IEC socket with loop-through output
Input impedance	75 Ω

Video

Modulation, FEC, demultiplexer	DVB-T standard
Video resolution	CCIR 601 (720 x 576 lines)
Frequency range	20 Hz to 5 MHz
Input data rate	
QPSK, Code Rate 1/2, Guard Int. 1/4	4.98 MSymbole/s to
64-QAM, Code Rate 7/8, Guard Int. 1/32 (acc. to EN 300 744, annex A)	31.67 MSymbole/s
Video decoding	MPEG-1 and MPEG-2 compatible
Bit rate	1.5-15 MB/s
Output voltage	1 V _{ss} /75 Ω
S/N	Typ. > 53 dB

Audio

Audio decoding	MPEG-1 and MPEG-2, Layers 1 and 2
Bit rate	32/44,1/48 kb/s
Frequency range	40 Hz to 20 kHz
Output voltage	Typ. 770 \pm 50 mV on 10 k Ω (TV Scart and Cinch)
S/N	65 dB

Hard Disk Recorder

Capacity	80 GB
Recording time	Up to 56 hours*

*dependent on data rate and picture contents

Power Supply

Supply volt./volt. supply receiver	230 V \pm 10%, 50 Hz/12 V
Power consumption	< 15 W
Power consumption in stand-by	typ. 10 W
Antenna amplifier supply	5 V/30 mA

Connections

TV connection	Scart socket, 21 pole
VCR/Aux connection	Scart socket, 21 pole
Audio output	2 x Cinch socket
Dolby Digital data stream output (AC 3)	Cinch socket
Ext. Infra-red receptor	Jack
Data interface for servicing	RS 232, Sub D 9 pole

General

Dimensions (W x H x D)	235 x 45 x 200 mm ³
Weight	About 1.4 kg

Temperature Range

Ambient temperature limit	+5 $^{\circ}$ C to +40 $^{\circ}$ C
---------------------------	-------------------------------------



Technical Features

Accessory

- 1 Infra-red remote control
- 2 Batteries 1.5 V , Type: LR 03, Size: AAA (Micro)
- 1 Scart cable
- 1 User manual

Scart Socket Seizure

Signal	Connection No.	TV	VCR
Audio right output	1	X	X
Audio right input	2		X
Audio left output	3	X	X
Audio GND	4	X	X
Blue GND	5	X	X
Audio left input	6		X
Blue signal	7	X	X
Switching voltage	8	X	X
Green GND	9	X	X
Data signal	10		
Green signal	11	X	X
Data signal	12		
Red GND	13	X	X
Data GND	14		
Red signal (C)	15	X	X
Blanking signal	16	X	X
Video GND	17	X	X
Blanking signal GND	18	X	X
Video output (comp. col./Y)	19	X	X
Video input	20		X
Connector screening	21	X	X

VHS/S-VHS Changeover

The Scart sockets can be changed over from VHS to S-VHS and the other way round. You can change over in menu item 'system parameters/A/V mode'.

- In VHS (**RGB**):
- The RED signal is on connection 15
 - Connection 19 is on the comp. col. output
- In S-VHS (**C/Y**):
- The C output is on connection 15
 - the Y output is on connection 19

Connection Example

DVB-T receiver connections with an entire television and HiFi system. The electrical digital audio output can be connected to a Dolby Digital unit.

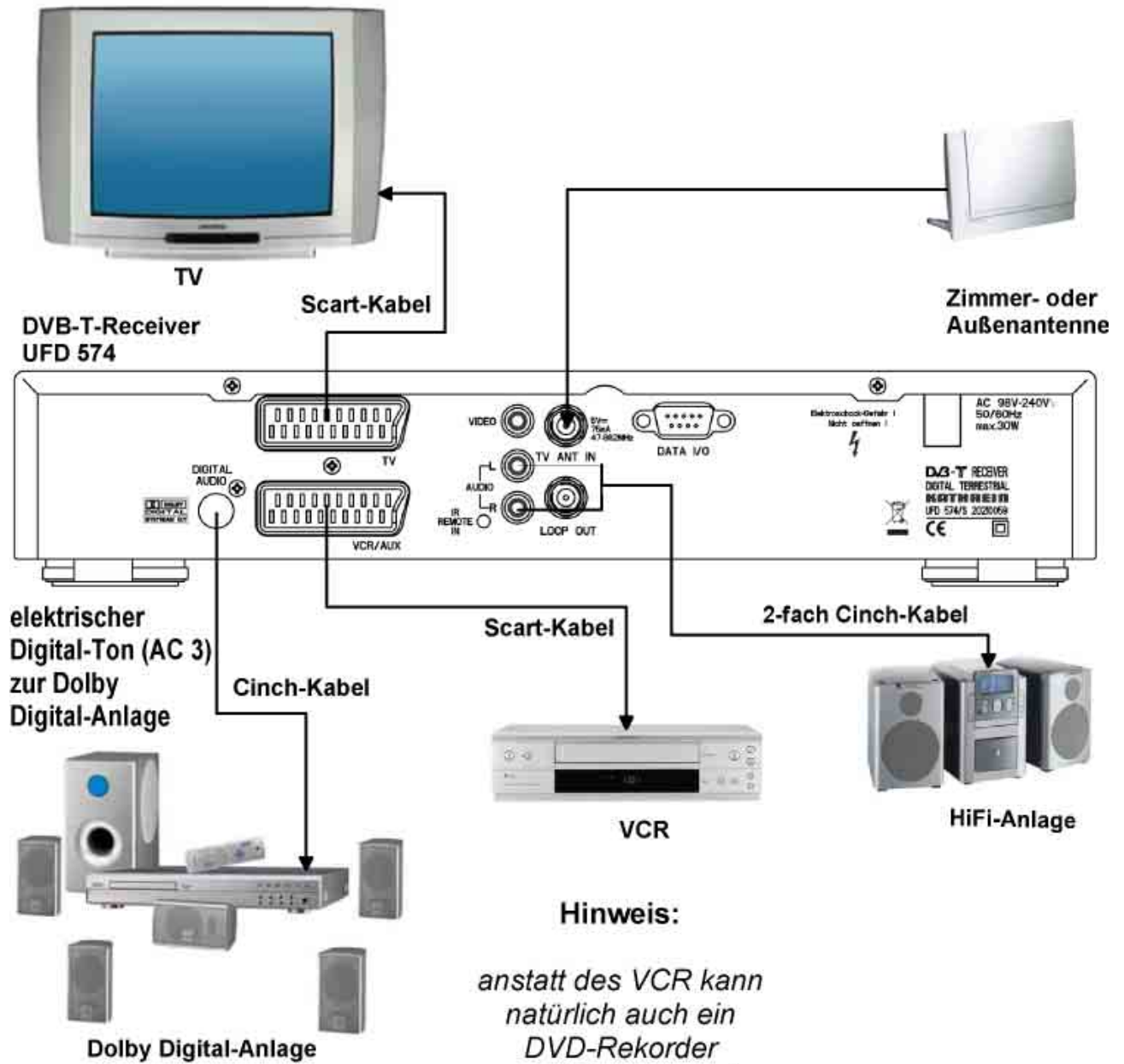

DVB MPEG-2

DVB is short for Digital Video Broadcasting. DVB-T points to the transmission method (T = terrestrial). MPEG is short for Moving Picture Experts Group, a task force drawing up internationally valid standards for the digital audio and video compression. MPEG-2 was made the standard in the compression of digital TV signals. MPEG-2 functions in a data rate of up to 100 MBit/s.

Eb/No ratio

The Eb/No ratio is a measure for the signal-to-noise ratio of the digital signal. This value is not identical to the C/N value known of the analogue reception technology. In the case of Eb/No values below 5 dB reception is normally no longer possible.

FEC

FEC is short for Forward Error Correction. The error rate FEC corresponds to the Viterbi rate.

PID

The PID number (Packet Identification) is an identification number for video and audio signals in the digital data stream of the DVB-MPEG-2 signals. With the PID number, the receiver can establish a clear allocation of the video and audio data transmission. The PID-PCR is the identification number for the synchronisation signal. The PID-PCR normally is identical to PID-Video. In multilingual programmes, another language could be assigned to the TV programme via manual audio PID input. After the PID input, the receiver automatically selects the audio data identified by the PID from the data stream and assigns them to the video signal.

Channel Package

For the most part, the channel package contains several TV and radio channels. Each channel package is fixedly assigned to the transmit frequency, the polarisation (horizontal or vertical), the symbol rate and the Viterbi rate or error rate.

Symbol Rate

The symbol rate describes the amount of data transmitted per second. The symbol rate is measured in MSymbole/s and equal to the amount of symbols coming in per second.

Video Bit Rate

The video bit rate describes the amount of data of the digitalised video signal transmitted per second.

Viterbi Rate

The Viterbi rate (Code rate, error rate) characterises the type of error protection utilised by the programme provider. The DVB standard determines the following values: 1/2 - 2/3 - 3/4 - 5/6 - 7/8

Glossary

Audio output	Audio output on the receiver
AV programme position	Favourite programme position of the TV set for the Scart input
DVB	Digital Video Broadcasting
Eb/No	Power density per information unit
Eb/No ratio	Digital signal-to-noise ratio
LED-Display	Display on the receiver
Mute	Mute function
OSD	On Screen Display
PAL	Analogue television standard
Pay-TV	Pay TV (e. g. Premiere)
PIN	Personal Identification Number
Receiver	Receiver
RGB	Video signal generated from three individual colour signals (red, green, blue)
Scart cable	21 pole connection cable
Stand-by	Operational readiness
S-VHS	Super Video Home System (Video recorder standard)
Symbol rate	Transmitted data rate of the transmit signal
Timer function	Time function for pre-programmed recordings
Viterbi rate	See encyclopaedia

Service

Language

German

Picture format

4:3

16:9

Antenna supply

Operation: ON Stand-by:

OFF

Further settings		
<input type="checkbox"/>	<input type="checkbox"/>	<input type="checkbox"/>
<input type="checkbox"/>	<input type="checkbox"/>	<input type="checkbox"/>

Free Manuals Download Website

<http://myh66.com>

<http://usermanuals.us>

<http://www.somanuals.com>

<http://www.4manuals.cc>

<http://www.manual-lib.com>

<http://www.404manual.com>

<http://www.luxmanual.com>

<http://aubethermostatmanual.com>

Golf course search by state

<http://golfingnear.com>

Email search by domain

<http://emailbydomain.com>

Auto manuals search

<http://auto.somanuals.com>

TV manuals search

<http://tv.somanuals.com>