

Operating manual

DVB Satellite Receiver UFS 650si/sw



KATHREIN

Antennen · Electronic

PREFACE

Dear customer,

This operating manual is intended to help you make the fullest use of the extensive range of functions offered by your new satellite receiver.

We have tried to make the operating instructions as easy as possible to understand, and to keep them as concise as possible. To help you understand particular specialist terms that cannot be translated, we have added a short glossary at the end of the manual.

The power switch is an environmentally friendly feature. If you will not be using your receiver for an extended period, you should use the power switch to disconnect it from the power supply and save energy. For shorter breaks, you can use the remote control to switch the receiver to standby, which uses only a minimal amount of energy.

We wish you good reception and much pleasure using your new DVB satellite receiver.

Your
KATHREIN team

IMPORTANT INFORMATION

The channels available on the satellites and transponders are subject to continual change. If changes do occur, the new channels have to be set in the receiver because the factory preset programming corresponds to the status on the date of manufacture. The information for these settings can be found on the Internet or in relevant magazines.

Your receiver is equipped in the factory with the latest software version at that time. We are, however, constantly working on adapting the software to the wishes of our customers and to developments in technology. The "Service Menu" section provides more information on this.

The information in this operating manual was correct at the time of going to press.

We reserve the right however to make changes at any time and without prior notice. If new software is released for your receiver, and this affects the information in the operating manual (e.g. changes to the menus and/or functions), if we believe it necessary we will make available a new operating manual for download under "www.kathrein.de".

**Please keep the original packaging in case you need to return the product at any time.
If the product is not properly packed, the warranty claim is invalidated.**

Make a note of the receiver's basic settings, so as to be able to restore them if necessary!

Before you switch off your receiver with the mains switch, you must first switch it into stand-by mode by pressing the stand-by button on your remote control. This ensures that modified and new data are saved to the receiver. As soon as the receiver is in stand-by mode, it can be switched off completely using the on/off switch on the receiver front panel. **Do not press the on/off button when the receiver is in operation!
This can lead to loss of data or damage to software.**

The term DiSEqC™, which appears in this user manual, is a registered trademark of the European Telecommunication Satellite Organization (EUTELSAT).

INFORMATION ON AUDIO MPEG INC. AND S.I.SV.EL, S.P.A:

This unit makes use of legally protected technologies, which are protected by patents in the USA and also by other intellectual property rights in other countries. KATHREIN-Werke KG has obtained licences from Audio MPEG Inc. and Societa' Italiana per lo sviluppo dell'elettronica, S.I.SV.EL, S.P.A to use these technologies. These licences carry certain restrictions, which apply also to you as the customer. Accordingly this unit may be used by the end customer only for private non-commercial purposes and for the licensed content. It may not be used for commercial purposes. The use of products or processes that are sold or used with this unit is not included in this statement. The use of reverse engineering is not permitted in respect of the licensed technologies, nor is disassembly.

DISPOSAL INSTRUCTIONS



Electronic equipment is not domestic waste - in accordance with directive 2002/96/EC OF THE EUROPEAN PARLIAMENT AND THE COUNCIL dated 27th January 2003 concerning used electrical and electronic appliances, it must be disposed of properly.

At the end of its service life, take this unit for disposal to an appropriate official collection point.



Spent batteries are special waste!

Do not throw spent batteries into your domestic waste; take them to a collection point for spent batteries.

CONTENTS

PREFACE	2
IMPORTANT INFORMATION	3
CONTENTS	4
SAFETY INSTRUCTIONS - IMPORTANT NOTES	6
RECEIVER FEATURES / SCOPE OF SUPPLY	7
CONTROLS, DISPLAYS AND CONNECTIONS	8
CONNECTION AND SET-UP	9
REMOTE CONTROL	11
FIRST INSTALLATION	12
OPERATING INSTRUCTIONS	28
MENU CONCEPT	28
MENU TREE	29
ALPHANUMERIC INPUTS	30
LANGUAGE SETTING - OSD	30
ON-SCREEN DISPLAYS (OSD)	31
CHANNEL MESSAGES	31
CHANNEL INFORMATION	31
CALLING UP THE OPTIONS CHANNEL	31
OPTION SELECTION	32
ERROR SIGNALLING	32
CHANNEL LIST – TV/RADIO	32
EPG - ELECTRONIC PROGRAMME GUIDE	34
CALLING UP THE EPG	34
“CURRENT” VIEW	35
“PREVIEW” VIEW (PROGRAMME LISTINGS)	36
ADDITIONAL INFORMATION (i BUTTON)	37
RECORDING (TIMER)	38
RECORD ONCE	39
RECORD DAILY	39
RECORD WEEKLY	40
PLAN RECORDING	41
VIDEOTEXT (TELETEXT)	42
EDIT CHANNEL LIST	43
SELECTION OF THE LIST / CHANNELS TO BE EDITED	43
EDITING LISTS / CHANNELS	44
“LAST FUNCTION” MEMORY	45
MOVE CHANNELS	45
DELETE CHANNELS	45
SKIP CHANNELS	45
LOCK CHANNELS	46
COPY CHANNELS TO THE FAVOURITES LIST	46
START BLOCKSELECTION (HIGHLIGHTING SEVERAL CHANNELS)	46

CONTENTS

EDIT FAVOURITES LISTS	47
REMOVE FROM THE FAVOURITES LIST	47
LOCK CHANNELS	48
RENAME FAVOURITES LIST	48
START BLOCKSELECTION (HIGHLIGHTING SEVERAL CHANNELS)	48
SEARCH CHANNELS (CHANNEL SEARCH).....	49
AUTOMATIC (CHANNEL) SEARCH.....	49
MANUAL (CHANNEL) SEARCH	51
CHANNEL SEARCH WITH SERVICE ID	53
PARENTAL CONTROL.....	55
LOCKING MAIN MENU	55
LOCK SET-TOP-BOX	55
DEFINE NEW PIN CODE.....	56
SETTINGS	57
TV SETTINGS (TV, PICTURE AND SOUND)	58
CUSTOMIZE SCREEN MENU.....	59
DATE AND TIME	60
COMMON INTERFACE	60
ANTENNA CONFIGURATION	60
SERVICE MENU	61
UPDATING SOFTWARE	61
RESTORE FACTORY SETTINGS.....	63
CONNECTING UP THE VIDEO/DVR	64
RECORDING.....	64
PLAYBACK.....	64
USING THE FRONT PANEL/SERVICE	65
TECHNICAL APPENDIX.....	66
FEATURES	66
SCART SOCKET ASSIGNMENT	68
VHS/S-VHS SWITCHING.....	68
CONNECTION EXAMPLE.....	69
EXAMPLES OF single-cable systems.....	70
SHORT TECHNICAL GUIDE	73
GLOSSARY	75
TROUBLESHOOTING.....	76

SAFETY INSTRUCTIONS - IMPORTANT NOTES

GB

Safety Instructions – Important Information

This page contains important information about the operation, installation location and connection of the unit. Read these instructions carefully before starting to use the unit.



DANGER!

Mains cable

Make sure that the mains cable (power supply cable) is not damaged. Units with a damaged mains cable must be disconnected from the mains (disconnect mains connector) and repaired by a qualified engineer before setup. Only use the power pack supplied (if available)!

Risk of death due to electric shock!

Cleaning

Disconnect the mains connector before cleaning the unit. Only use a dry cloth for cleaning and only clean the outer surface. Never open the unit.

Touching the parts inside the unit carries a risk of death due to electric shock!

Playing children

Make sure that children do not push any objects into the ventilation slots.

Risk of death due to electric shock!



WARNING!

Earth connection

The antenna system must be earthed as specified or equipotentially bonded. EN 60728/11 and any national regulations must be complied with.

Danger due to surge voltages, lightning strikes!

Mains voltage

Only operate the unit with the specified mains voltage (marked on the rear of the-unit or on the external power pack)! The unit may only be connected to the mains and turned on once it has been connected to the antenna and to the TV set or the cable network and PC.

If the mains voltage is too high, there is a risk of fire!

Repairs

Ensure that any repairs to your unit are carried out by qualified personnel. Opening the unit and attempting to repair it yourself voids all warranty claims! Improper work on the unit can jeopardise the electrical safety of the unit.

The manufacturer accepts no liability for accidents caused by the user opening the unit!



CAUTION!

Connections

Incorrect wiring of the connections can lead to malfunctions or defects on the unit!

Long periods of absence/storms/accessibility of the mains connector

Always turn off the unit at the mains switch if you will be absent for a long time or there is a storm. Disconnect it from the mains by unplugging the mains connector. This also applies to the other equipment connected to the unit. Isolation from the cable network is also recommended. Note any timer programs (receiver) and turn the unit on again promptly before the recording time. Ensure the mains connector is accessible at all times.



Installation location

All electronic equipment generates heat. However, the heating of this unit lies within the permissible range. Sensitive furniture surfaces and veneers may become discoloured by the effects of constant heat over time. The feet of the unit can also cause colour changes to treated furniture surfaces. If necessary, place the unit on a suitable stable and flat base!



Ventilation

The heat generated in this unit is adequately dissipated. However, the unit should never be installed in a cupboard or on shelves with inadequate ventilation. Never cover the cooling slots on the unit (e.g. with other equipment, magazines, tablecloths or curtains)!

Do not place any objects on top of the unit and maintain a clearance of at least 10 cm above the unit, so that the heat generated can be dissipated with no obstructions.

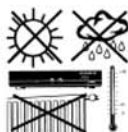

Moisture, sunlight, heat, naked flames

Protect the unit against moisture, dripping and splashed water (do not place any filled objects such as vases on top of the unit). Do not place the unit close to a heater or expose it to direct sunlight and do not operate it in damp locations. Only use the unit in a moderate climate, not in tropical conditions! Do not expose the unit to any naked flame, such as from a candle! This constitutes a fire hazard!

RECEIVER FEATURES / SCOPE OF SUPPLY

The UFS 650 is suitable for reception of digital satellite TV and radio programmes. The HDMI interface enables connection of a flat-screen TV for optimal viewing comfort. An integrated upscaler ensures optimal picture processing for flat-screen TVs.

Features include: Kathrein EPG, guided first installation with national programme lists, electrical audio output for Dolby Digital (AC 3), a video Cinch output and videotext with 800-page memory capacity.

The receiver is available in silver and black.

PRODUCT PACKAGE

- UFS 650
- Remote control RC 671
- Scart cable
- 2 batteries AAA 1.5 V
- Power supply unit 230 V/ 12 V
- Operating manual
- Safety Notes

DISPLAY OF ANTENNA SIGNAL LEVEL AND EMISSION OF SEARCH TONE (SAT FINDER) ON THE TV SET

Initial installation must first be completed before you can use the search tone to align the antenna.

Press the -Taste to access the main menu and

press the -button for three seconds to activate the search tone. On the screen, you will then be able to see the menu "antenna configuration" where the bars signal strength and signal quality are displayed. At the same time, the receiver will display the current signal strength (available at the receiver input).

The higher the tone, the better the signal strength.

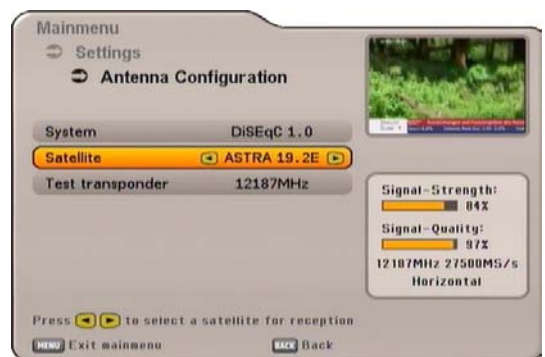

Press the -Taste button to switch off the tone and exit the menu..

CONTROLS, DISPLAYS AND CONNECTIONS

This section provides a brief description of all the controls, displays and connections.

VIEW OF FRONT PANEL (FLAP REMOVED)

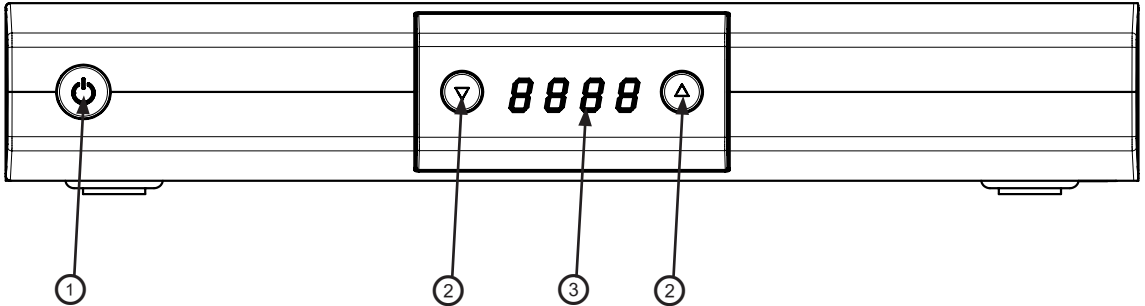

VIEW OF REAR PANEL

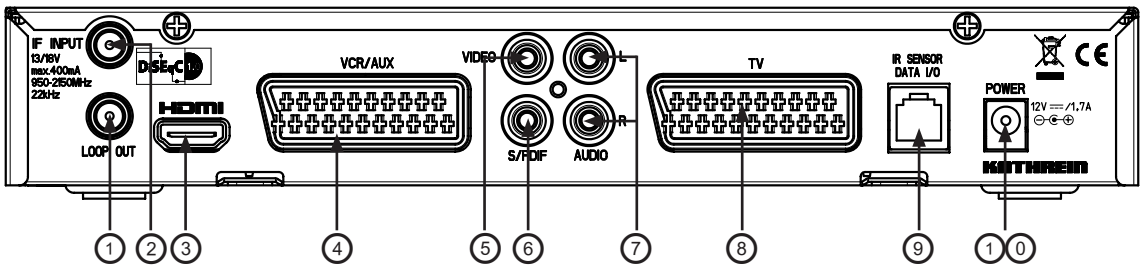

Front Panel Controls and Displays

1. On/Off switch (with mains disconnect)
2. Channel select buttons - (▼▲)
3. Display

Rear Panel Controls and Displays

1. LNB loop-through input
2. LNB input
3. HDMI output
4. Scart socket for VCR/AUX connection
5. Video output (composite colour)
6. Electrical data stream output (SPDIF/Sony Philips Digital Interface Format) for Dolby Digital AC 3 audio
7. Audio outputs (L/R) - cinch sockets
8. Scart socket for TV connection
9. RJ 11 data interface / connection port for an external IR sensor
10. Mains power cable

CONNECTION AND SET-UP

The following section is intended specifically for specialist dealers. You need not refer to this section unless you are carrying out the installation yourself.

The "Connection examples" section provides a sample configuration.

Do not connect the receiver to the power supply until all installation work has been properly carried out. Refer to the information in the "Safety instructions" section.

CONNECTING THE UNIT (SAT-IF CONNECTIONS)



Connect the Sat IF input on the receiver to the satellite reception system. Use a coaxial cable with a standard F connector.

If the F standard connectors are not yet fitted on the cables, strip the insulation from the cables as shown in the following illustration and carefully screw the F standard connectors on to the ends of the cables until they are securely seated.

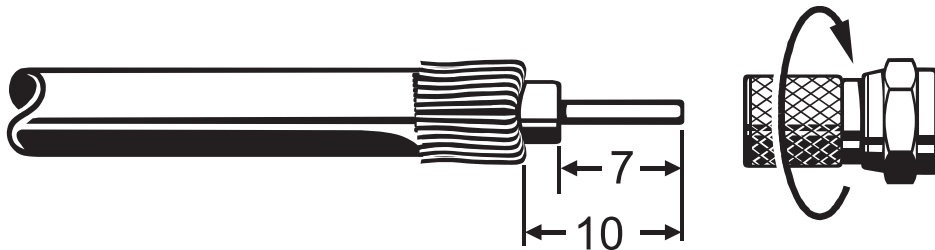

When fitting the connector, make sure that no wires from the braid are touching the inner conductor, so no short circuit can occur.

The quality of the reception signal depends on this connection.

RECEPTION REQUIREMENTS



Make sure that your own satellite antenna system is equipped at least with a universal LNB for digital reception in the high-band range.

RECEPTION SYSTEM PRESETS

The presets for the control signals have been made for standard reception systems, i.e. 14/18 V for polarity reversal and 22 kHz switching signal for low/high band changeover on multi-feed reception systems.

CONNECTION AND SET-UP

TV AND VIDEO RECORDER CONNECTION

Connect the satellite receiver (TV Scart socket) and the TV set using a Scart cable (see "Connection Example"). If your TV has a stereo capability, you can receive the sound in stereo via the Scart connection. Use a further Scart cable to connect the satellite receiver (VCR/Scart socket) to the video recorder/DVR. For system reasons, the same video signals are to be found at the TV Scart socket as at the video cinch output.



If you are recording using an external video recorder, remember not to operate the receiver during recording, otherwise all the on-screen displays will appear on your recording.

AUDIO CONNECTION

If you want to play the sound on your hi-fi system, connect the audio cinch sockets to the input sockets on the hi-fi system, using an appropriate cable (see "Connection Example").

ELECTRICAL DIGITAL OUTPUT

The electric digital output is intended for the connection of a Dolby Digital system (see "Connection Example").

INSERTING BATTERIES INTO THE REMOTE CONTROL

Remove the cover on the rear of the remote control.
Insert the two batteries supplied into the remote control. Ensure correct polarity of the batteries; the + and – markings as indicated inside the battery compartment.
Slide the cover back into the housing until it locks in place.

REMOTE CONTROL



Numeric input for channels, timers etc.



Open the main menu, leave the menu and return to the TV picture



Volume



Sound on/off



FAV (red)
Open favourites selection



PIP (green)
"Current" view in the EPG



Open EPG (Electronic Programme Guide)



Leave the menu step by step



Changing channel in the programme preview (EPG)



(red)
Recording in EPG, editing in channel list



Currently not used

Power on / stand-by



Videotext (Teletext)



Access Channel Notification/Info



Channel selection up/down



OPT (yellow)
Open channel options sound/subtitles selection



TV/R (blue)
Switch between TV/radio



Cursor buttons



Confirm entry open channel list



Changing channel in the programme preview (EPG)



Stop recording



AV mode

The button symbols shown here can also be found in the description of the operating steps.

FIRST INSTALLATION: General

Before using your receiver for the first time, read the “Safety Instructions” and “Connection and Setup” sections.

The “Connection examples” section provides a sample configuration.

Do not connect the receiver to the power supply until all installation work has been properly carried out.

The guidance given in the “First Installation” section assumes that the receiver has been properly connected as per the “Safety Instructions” and “Connection and Setup” sections.





First switch your TV set on and select the AV channel slot. Switch on your receiver at the power switch at the front of the unit. The following display appears:



Also pay attention to the bars at the bottom of the on-screen display! These provide information on what to do next.

Select the menu language you want using the   buttons. Available options: German, English, French, Italian, Spanish, Czech, Dutch and Turkish.





Press the  (green) button to move to the next menu.

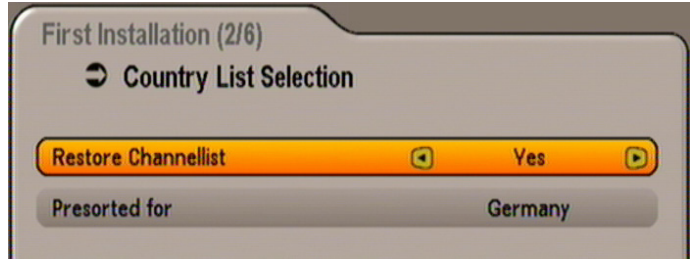

Note: If you are unsure whether you chose the right option from a previous menu, you can go back a step at any time during the first installation process by pressing the  (red) button.

FIRST INSTALLATION: General

The following display appears:



Use the   buttons here to select whether you wish to use the pre-programmed channel list (select “no”) or generate a new channel list by searching (select “yes” - you will be asked later in the first installation to compile this list). Press the   buttons to access the next line.

Use the   buttons to select the country for which you wish to load the pre-programmed channel list (this is relevant only if you did not reject the pre-programmed channel list). Press the  (green) button to move to the next menu.

The following display appears:



Use the  buttons here to select the settings for your TV set.

When doing this, refer to the operating instructions for your TV set!

TV format

Select the TV's picture format. Either

4:3 or
16:9

FIRST INSTALLATION: General

Picture format

Here you select the type of screen display, depending on the setting of your TV format:

- TV format "4:3": Pan & Scan or Letterbox
- TV format "16:9": "Automatic" or "Always 16:9"

TV-Scart-Output

Select the type of video signal at the TV Scart socket here. Select the signal that your TV set can process.

- FBAS - composite colour signal or
- RGB - Red/Green/Blue signal



HDMI format

Here please select the format (resolution) that will be output at the HDMI socket. Select the resolution appropriate to your TV set.

Available options: Auto (automatic format choice), 576p, 720p or 1080i

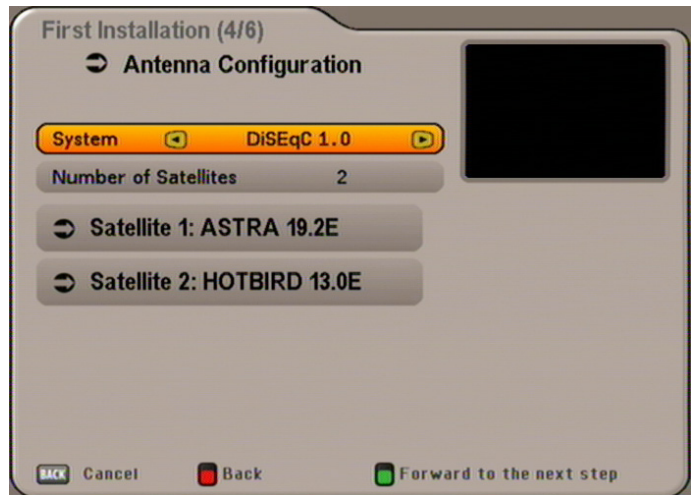
Press the  (green) button to move to the next menu. The following display appears:



Use the   buttons here to select the setting to match your reception system. You have the following options:

- DiSEqC™1.0
- Simple LNB or
- Single-cable system



Now continue with the first installation chapter that applies to your reception system.

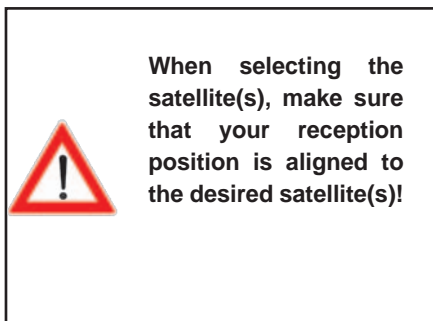

When selecting the LNB type in the setting that applies to you, note that "Wideband" is available only for the "single-cable system" setting!

FIRST INSTALLATION: DiSEqC™1.0







Use the   buttons here to switch to the “Number of Satellites” selection

Number of Satellites

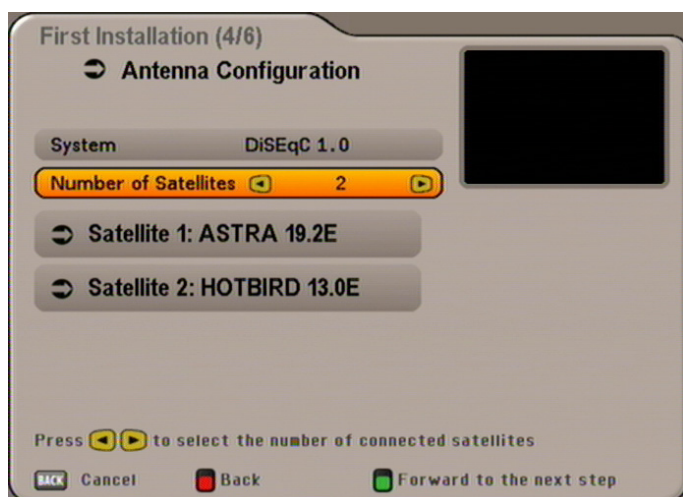
Press the  button to select the number of satellites to be received. You can select a number from one to four satellites to be received.

The following display appears (example):



Use the   buttons to select the first satellite slot. Press the  button to open the menu for the satellite settings.

FIRST INSTALLATION: DiSEqC™1.0

The following display appears (example):

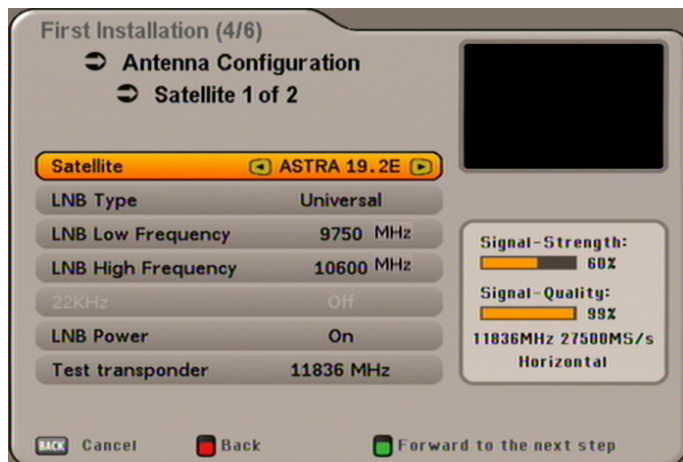

Satellite and Position

Use the buttons to set the desired satellite (selection from 17 pre-programmed options).

LNB settings

Use the buttons here to select the LNB type used in your system. The choice is between “Universal” and “user-defined”.

Universal:

No further input is required, since all necessary frequency ranges are covered by a universal LNB.

User-defined:

If you choose not to use a universal LNB, you must here set the frequency ranges for which your LNB was configured.

Use the buttons to select the frequency range to be changed (low / high frequency).

Use the buttons or the keypad to set the exact frequency for which your LNB was configured.

Test transponder

To check whether the settings that you have made are correct, use the buttons to move to the “Test transponder” field. Use the buttons to select the required transponder from the various ones listed. If your settings are correct, you will see at the top right of the screen the live signal of a channel for the currently selected transponder.

If you do not receive a signal, check your settings again and if necessary call for expert help.

You have now completed all settings for the first satellite. Press the button to return to the “Satellite Selection Menu” and perform the settings in the same way for the remaining satellites. When you have finished configuring the satellite press PIP (green). The receiver then automatically calls up the selection menu for the channel search. Continue by selecting the item (“Perform channel search”).

FIRST INSTALLATION: Simple LNB

Satellite and position

Use the buttons to select the desired satellite whose signal is to be received by the tuner.

When you have selected your desired satellite, use the buttons to switch to the selection of the “LNB Type”.

LNB settings

Use the buttons here to select the LNB type used in your system. The choice is between “Universal” and “user-defined”.

Universal:

No further input is required, since all necessary frequency ranges are covered by a universal LNB.

User-defined:

If you choose not to use a universal LNB, you must here set the frequency ranges for which your LNB was configured.

Use the buttons to select the frequency range to be changed (low / high frequency).

Use the buttons or the keypad to set the exact frequency for which your LNB was configured.

LNB voltage

Use the buttons to select whether your LNB is supplied with power from the receiver (“On”) or whether it has its own power supply (“Off”).



Test transponder

To check whether the settings that you have made are correct, use the buttons to move to the “Test transponder” field. Use the buttons to select the required transponder from the various ones listed. If your settings are correct, you will see at the top right of the screen the live signal of a channel from the currently selected transponder.

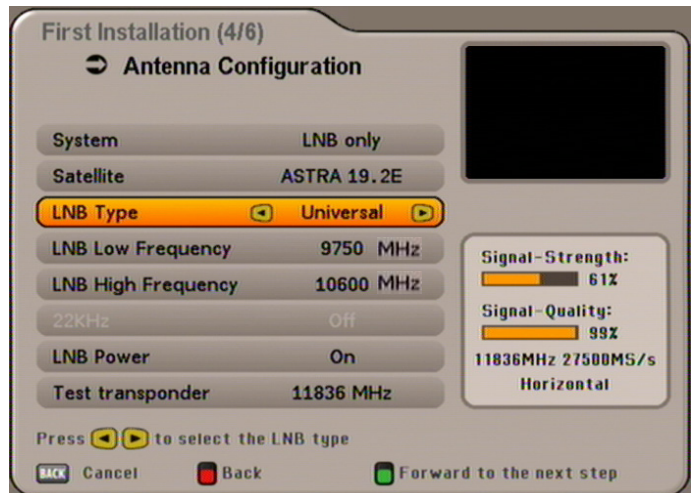
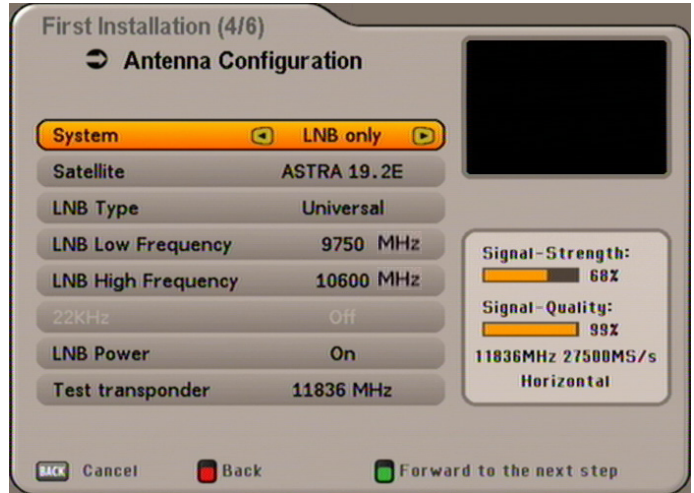
If you are not receiving a signal, check your settings again and if necessary call for expert help.



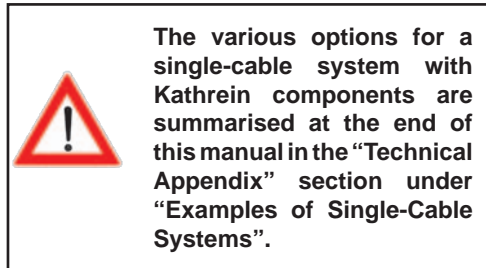

FIRST INSTALLATION: One Cable

Use the   buttons here to select “One cable” as the “System”. Press the  button to move to the next menu item. The following display appears:



Number of satellites

Use the   buttons to select how many satellites (max. 2) you would like to receive with your reception system. Press the  button to move to the next menu item.

Configure satellites

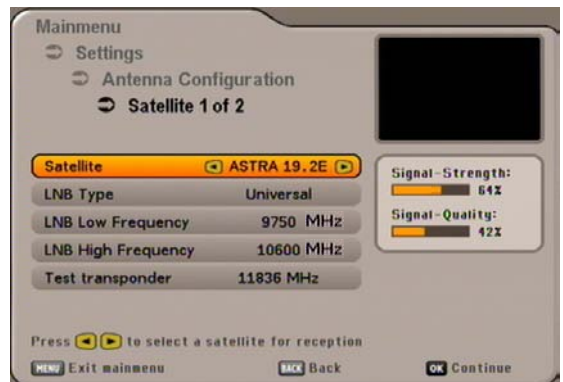

Press the  button to open the menu. The following display appears:

Satellite and Position



Use the   buttons to select the first satellite (satellite 1 of 2, depending on the setting), as shown on the screen.

LNB settings

Use the   buttons here to select the LNB type used in your system. The choice is between “Universal”, “Wideband” and “Single”.

If in your reception system you use a single-cable LNB (e.g. UAS 481 from Kathrein), please select here the setting “Wideband”. If you use a single-cable matrix (EXU 908) or a single-cable changeover matrix (EXR 551 or EXR 552) from Kathrein, the LNB you use must be a “Universal LNB”!

FIRST INSTALLATION: One Cable

Universal:

No further input is required, since all necessary frequency ranges are covered by a universal LNB.

Wideband:

No further input is necessary, since all frequency ranges are set by the Wideband LNB.

Single:



If you are not using a Universal or a Wideband system, you must set the frequencies here. You can find the necessary information in the documentation supplied with your system.

Use the   buttons to select the line "LNB Low Frequency"). Use the   buttons or the keypad to set the exact frequency for which your LNB was configured.



When you have completed all setting for the currently selected satellite, press the  button. If you have selected more than one satellite, repeat the previous "Satellite and Position" and "LNB Type" processes for the number of satellites you selected.

When you have completed the settings for all the satellites, the following display appears:

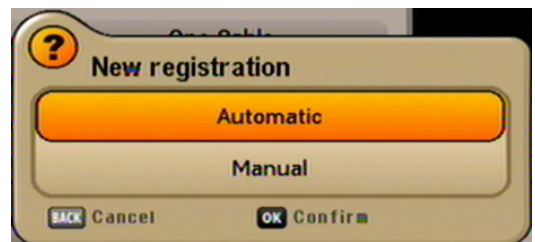

Use the  button to select the next menu item "New registration", then press the  button. The following display appears:



Use the   buttons to select the desired type of installation and confirm your selection using the  button. For clarity, we have split further details into two sections.

Firstly we give details of "Automatic" installation, then details of "Manual" installation.



FIRST INSTALLATION: Single-cable system (automatic)

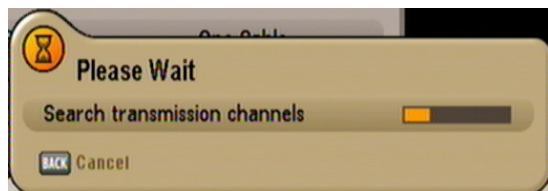

If one or more receivers are already present on the system and an additional receiver is to be connected, when assigning the transmission frequency for the new receiver make sure that no transmission frequencies are duplicated. No frequency can be used by more than one receiver.

The receiver searches for the transmission channels on your single-cable system and shows in the next display the available transmission channels.



Use the   buttons to select the transmission channel you want and confirm the selection with the  button.

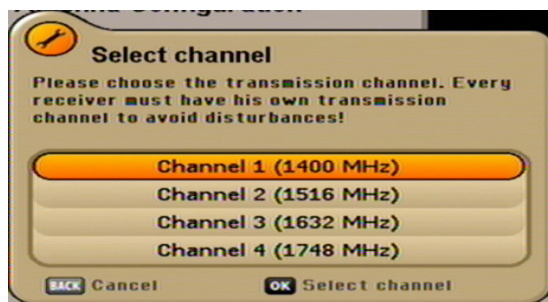

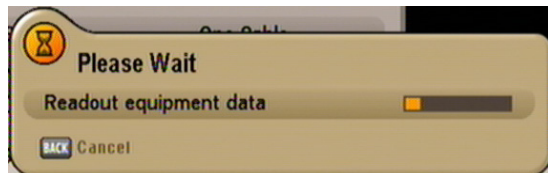

No frequency can be used by more than one receiver. The receivers would interfere with each other.

The receiver now reads the existing system data for your single-cable system and configures itself.



The receiver has been successfully registered on your single-cable system. Confirm the display

with the  button. Now press the  (green) button. The receiver will automatically display the menu for the channel search. Continue with the item ("Perform channel search").

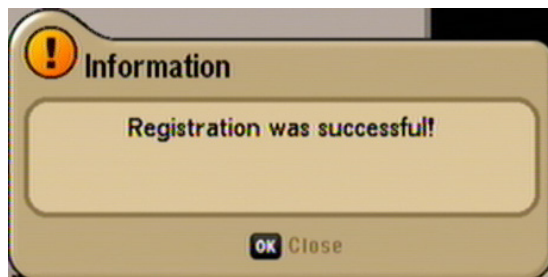

If no connection to the single-cable system could be established, you will receive the message "Registration was abortive!". Check your settings and if necessary call for expert help.



FIRST INSTALLATION: single-cable system (manual)

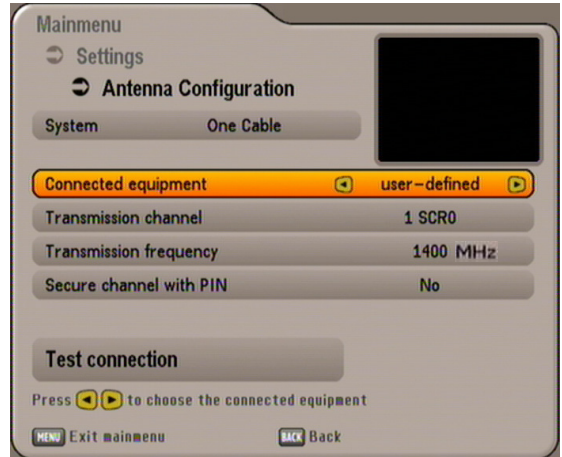

If one or more receivers are already present on the system and an additional receiver is to be connected, you must assign the new receiver a transmission frequency that is not already in use (otherwise the receivers will interfere with each other). Depending on the system to which they are connected, a maximum of four or eight receivers may be connected to a single-cable system (a twin receiver counts as two receivers)



Connected equipment

Use the   buttons to select the type of system to which they are connected or the single-cable system components fitted (refer to the manuals, instructions and notes for the system and the system components). Available options:

- user-defined
- KATHREIN UAS 481 (single-cable feed system, max. four receivers)
- KATHREIN EXR 551 (single-cable switching matrix, max. four receivers)
- KATHREIN EXR 552 (single-cable switching matrix, max. four receivers)
- KATHREIN EXU 908 (single-cable matrix, max. eight receivers)
- EXR 4 subscriber (for future Kathrein single-cable (switching) matrices, max. four receivers)
- EXR 8 subscriber (for future Kathrein single-cable (switching) matrices, max. eight receivers)

Selection “user-defined”

Transmission channel

Use the   buttons to select a free available transmission channel.

Transmission frequency

Use the number buttons to input the four-digit transmission frequency.





No frequency can be used by more than one receiver. The receivers would interfere with each other. You can find the necessary information (transmission frequencies) in the documentation supplied with your system.

Secure channel with PIN

If your single-cable system allows the transmission frequency to be protected by inputting a PIN, this is the menu where that can be done. No other receiver can then use that transmission frequency unless the PIN is input.







Use the   buttons to select the setting “Yes”. A line with the text “Password PIN” is then displayed.

Press the   buttons to select this line. You can now use the number buttons to enter a PIN (0-255).

FIRST INSTALLATION: single-cable system (manual)

Test connection

When you have completed all the settings, press the   buttons to switch to the “Test connection” selection field and press the  button. The receiver now tests whether a connection to the single-cable system can be established or not. As soon as the receiver has established a connection to the single-cable system, you will see the following display:

Confirm this display with the  button. Then press the  button. You will be asked whether you wish to save the changes. Use the   buttons to select “Yes, save changes” and confirm by pressing the  button. Now press the  (green) button.

The receiver will automatically display the menu for the channel search. Continue by selecting the item (“Perform channel search”).

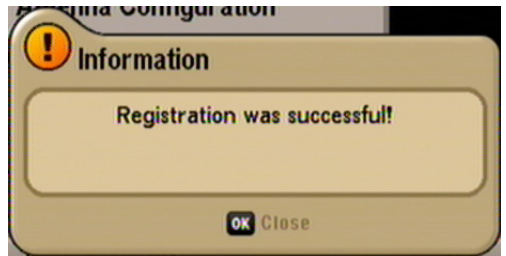

If no connection to the single-cable system could be established, the following display appears:

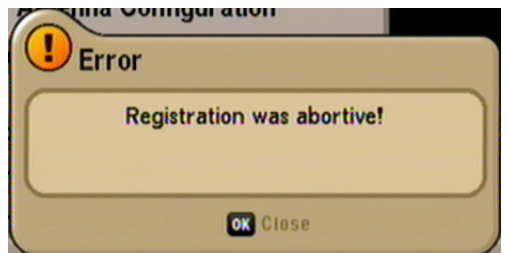



Check your settings (frequency and transmission channel) and if necessary call for expert help.

FIRST INSTALLATION: single-cable system (manual)

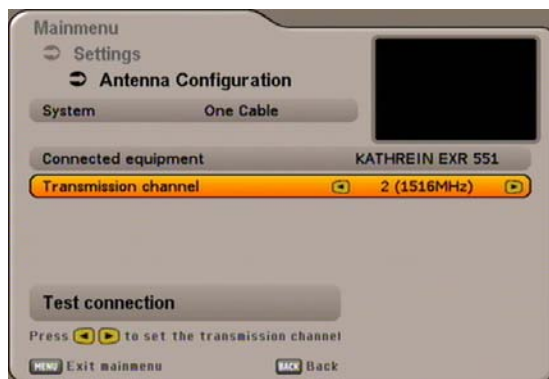
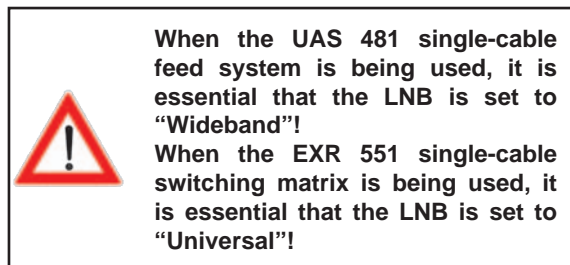

Selection "UAS 481" or "EXR 551"









Transmission channel

Use the   buttons to select a free available transmission channel. A maximum of four transmission channels are available (1400, 1516, 1632 and 1748 MHz).

Test connection

When you have set a free transmission channel, press the   buttons to switch to the "Test connection" selection field, then press the  button. The receiver now tests whether a connection to the single-cable system can be established or not. As soon as the receiver has established a connection to the single-cable system, you will see the following display:

Confirm this display with the  button. Then press the  button. You will be asked whether you wish to save the changes. Use the   buttons to select "Yes, save changes" and confirm by pressing the  button. Now press the  (green) button.

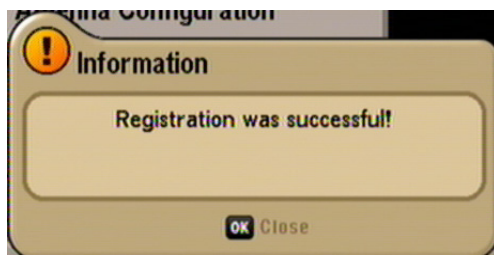

The receiver will automatically display the menu for the channel search. Continue by selecting the item ("Perform channel search").

If no connection to the single-cable system could be established, the following display appears:

Check your settings and if necessary call for expert help.

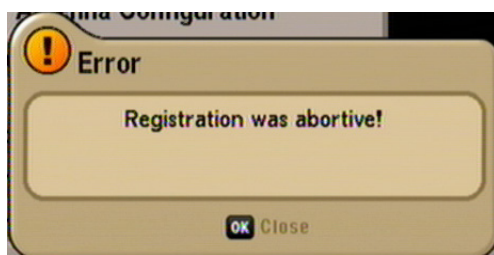

FIRST INSTALLATION: single-cable system (manual)

Selection "EXR 552"



When the "EXR 552" single-cable switching matrix is being used, it is essential that the LNB is set to "Universal"!



Transmission channel

Use the buttons to select a free available transmission channel. A maximum of two transmission channels are available (1400 and 1516 MHz).

Test connection

When you have set a free transmission channel, press the buttons to switch to the "Test connection" selection field, then press the button. The receiver now tests whether a connection to the single-cable system can be established or not. As soon as the receiver has established a connection to the single-cable system, you will see the following display:

Confirm this display with the button. Then press the button. You will be asked whether you wish to save the changes. Use the buttons to select "Yes, save changes" and confirm by pressing the button. Now press the (green) button.

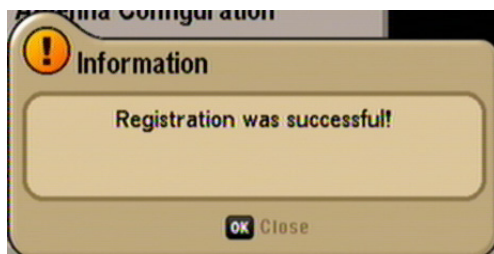

The receiver will automatically display the menu for the channel search. Continue with the section (Execute channel search).

If no connection to the single-cable system could be established, the following display appears:

Check your settings and if necessary call for expert help.

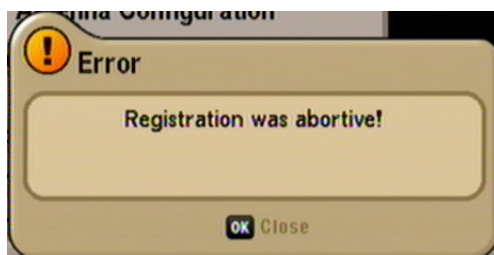

FIRST INSTALLATION: single-cable system (manual)

Selection "EXU 908"



When the "EXU 908" single-cable matrix is being used, it is essential that the LNB is set to "Universal"!

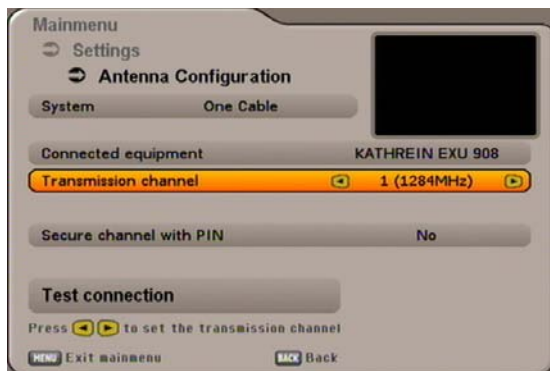

Transmission channel

Use the buttons to select a free available transmission channel. A maximum of eight transmission channels are available (1284, 1400, 1516, 1632, 1748, 1864, 1980 and 2096 MHz).

Secure channel with PIN

The EXU 908 single-cable matrix allows the transmission frequency to be protected by inputting a PIN. No other receiver can then use that transmission frequency unless the PIN is input.

Use the buttons to select the setting "Yes". A line with the text "Password PIN" is then displayed.

Press the buttons to select this line. You can now use the number buttons to enter a PIN (0-255).

Test connection

When you have set a free transmission channel, press the buttons to switch to the "Test connection"

selection field, then press the button. The receiver now tests whether a connection to the single-cable system can be established or not. As soon as the receiver has established a connection to the single-cable system, you will see the following display:

Confirm this display with the button. Then press the button. You will be asked whether you wish to save the changes. Use the buttons to select "Yes, save changes" and confirm by pressing the button. Now press the (green) button.

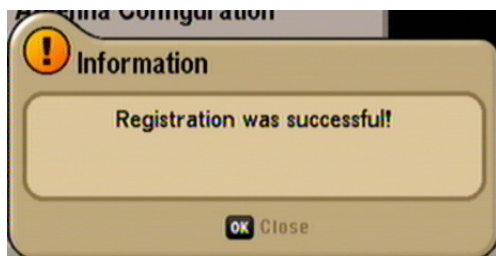

The receiver will automatically display the menu for the channel search. Continue with the section (Execute channel search).

If no connection to the single-cable system could be established, you will receive the message "Registration was abortive!".

Check your settings and if necessary call for expert help.

FIRST INSTALLATION: Channel search

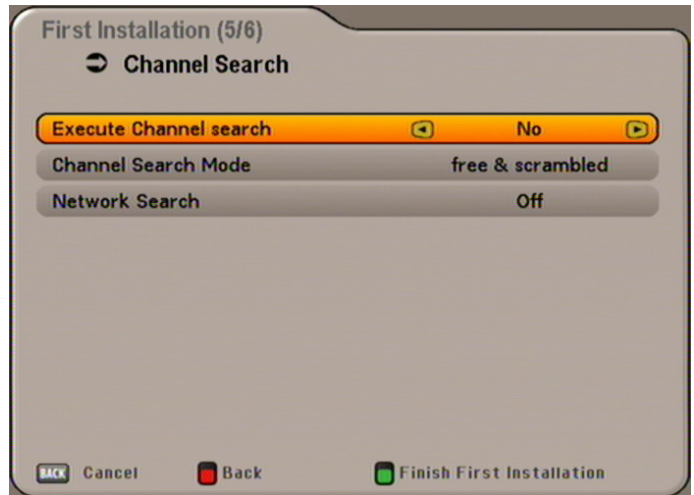

Perform a Channel search

Use the buttons to select (yes or no) whether you wish to start a channel search. It is not essential to start a channel search; instead you can use the factory pre-programmed channels. However the channels do change from time to time (e.g. their frequencies change), which the receiver does not automatically detect, and can then be found only by performing a channel search.

If you selected “No”, you can press the (green) button to skip directly to the next item of the first installation.

If you selected “Yes”, you can press the button to progress to the next selection item.

Channel Search Mode

Use the buttons to select whether you wish to search “free & encrypted”, “only free” or “encrypted only” channels.

The UFS 650 does not allow encrypted channels to be viewed, because no Common Interface is fitted for insertion of the necessary CA modules and smart cards.

Press the button to move to the next selection item.

Network Search

If you set the network search to “Off”, only the factory stored transponders of the satellites you previously selected will be scanned for new and as yet unlisted channels.

If you set the network scan to “On”, the transponder network enables additional transponders that have not yet been stored to be located. They are then stored and searched for new channels in the same way as the existing transponders.

Press the (green) button to start the channel search, or if you set channel search to “Off” you are guided straight to the next item in the first installation process.

When the search has been completed, you will see the following message (example):

FIRST INSTALLATION: Channel Search/Date and time





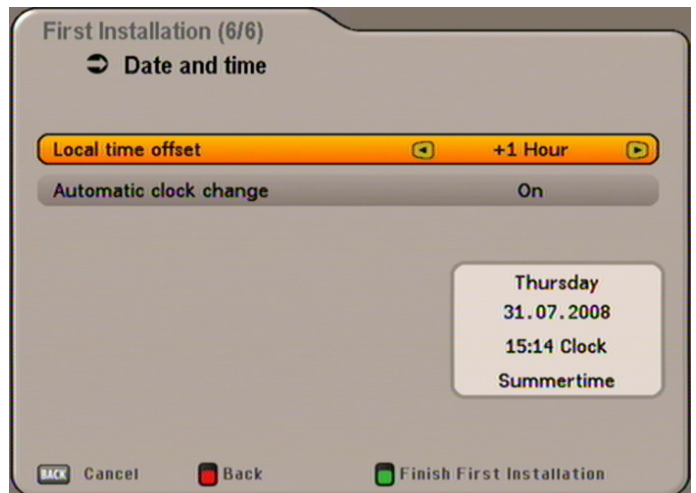

Use the  button to move to the next step of the first installation. The following display appears:



Local time offset

Use the   buttons to set the time zone variation from UTC (formerly GMT) (e.g. for Germany +1 hour).

Use the   buttons to switch to the “Automatic clock change” field. Use the   buttons to select whether the receiver should automatically change over to and from summer and winter time. If “On” is selected, the receiver automatically sets itself to the right time. If “Off” is selected, the field for manual selection of summer and winter time is displayed below.

Press the   buttons to perform the setting.

Press the  (green) button to close First Installation and return to the TV picture.

OPERATING INSTRUCTIONS

MENU CONCEPT

The structure of the menu concept is based on logical operating sequences. The programme showing on the current selected channel always appears in the top right-hand corner of the screen.

You will find detailed descriptions of the selected menu items in the relevant sections of the operating manual.

Note: *The selected menus, sub-menus and positions, as well as the parameters to be set, are each highlighted in colour. The menus are self-explanatory.*

Pay attention to the bar at the bottom of the on-screen display. These provide information on what to do next.

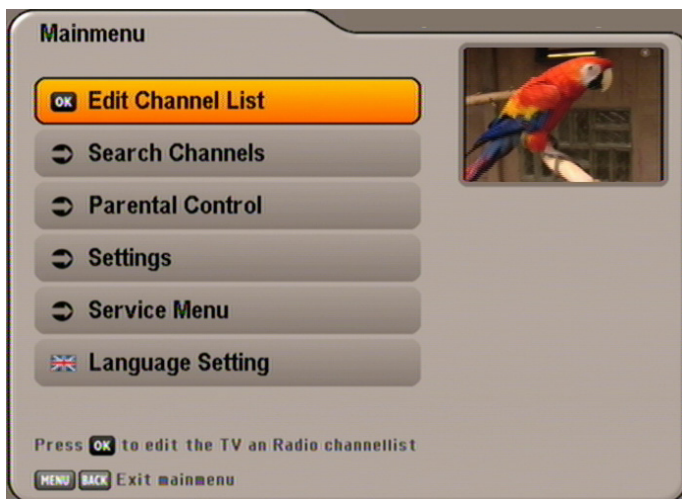

Press the **MENU** button to open the main menu, and use the **▲** **▼** buttons to select the sub-menus.

Press the **OK** button to access the sub-menus. Use the **▲** **▼** buttons to select the sub-menu options.

The settings under the various options are made either by pressing the **◀** **▶** buttons or using the numeric pad. You can exit the main menu and sub-menus, and the various options, step-by-step by pressing the **BACK**

button (the settings/changes you made are saved). Press **MENU** to return directly from one of the menus to the TV picture (the settings/changes you made are saved).

OPERATING INSTRUCTIONS

MENU TREE

Main Menu

Open the menu by pressing the  button

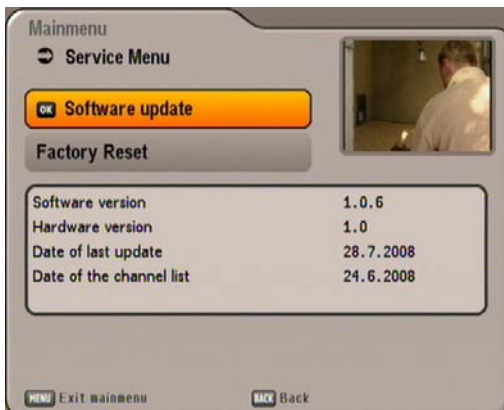
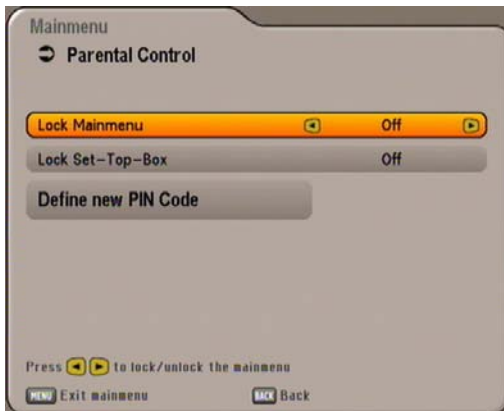
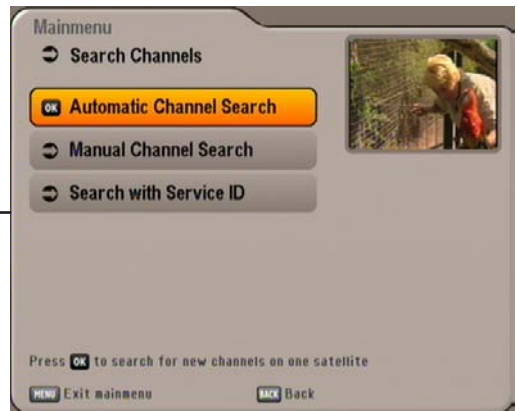

OPERATING INSTRUCTIONS

ALPHANUMERIC INPUTS

Use the displayed keypad (see figure to the right) for entry of favourites names or search expressions by selecting numerals for the desired letters / digits. You can write

with upper or lower case letters ( button). Use the numeric pad to select the desired character. About two seconds after selection of the character, the cursor moves automatically to



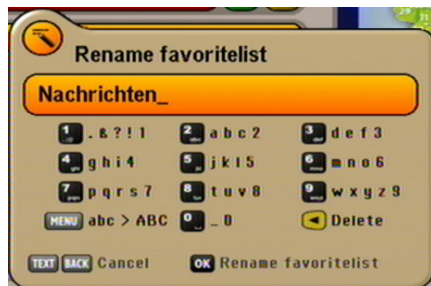



the next position. The  button allows you to delete your entry character by character.



When you have selected all the characters, press the  button to save your entry and start a scan to find the desired expression.

LANGUAGE SETTING - OSD

The language for the on-screen display is set as follows:

 →   → Language setting →  →   → English → 

Available options: German, English, Italian, French, Dutch, Spanish, Czech and Turkish.

After you have performed the settings, press the  or  button to exit the main menu. You will then return to the TV picture.

ON-SCREEN DISPLAYS (OSD)

CHANNEL MESSAGES

TV CHANNEL MESSAGES

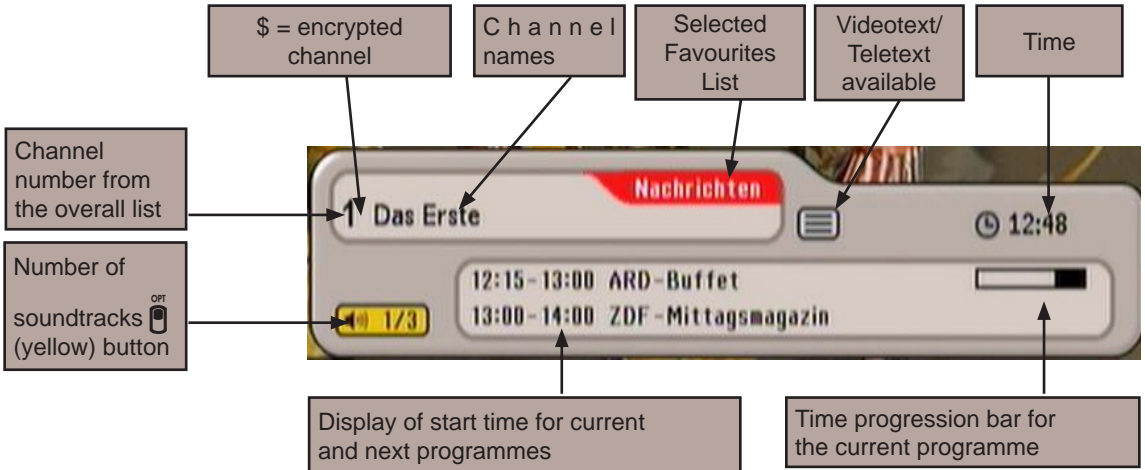

Channel information is shown for a few seconds each time the channel is changed (this can be changed under "Settings", "Customize screen menu") or displayed continuously by pressing the button.

RADIO CHANNEL MESSAGES

The information for the current radio channel has the same layout.

CHANNEL INFORMATION

Press twice to view information on the current channel, if transmitted by the channel provider.



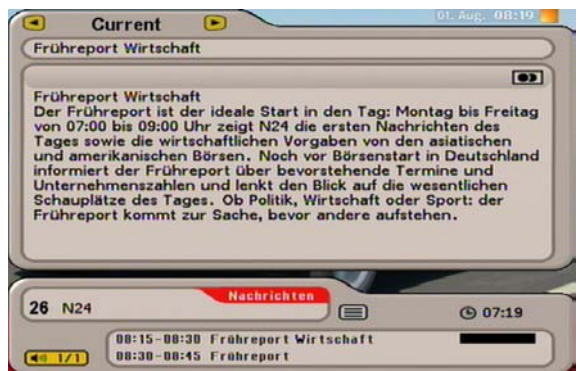



Use the buttons to scroll through the pages. By pressing the buttons you can obtain information on the programmes to come on the current channel. Press the or button to exit the display.







CALLING UP THE OPTIONS CHANNEL

If the channel OSD contains the following icon , this is a portal channel. Press the (yellow) button to display the channels available on this portal (such as matches on a specific day of play). In this example three "sub-channels" are available for selection within this portal channel.

ON-SCREEN DISPLAYS (OSD)

Select the channel using the   buttons . You can also however select the sub-channels of a portal channel directly using the   buttons, without having previously pressed the  (yellow) button.

OPTION SELECTION

Press the  (yellow) button once (twice for portal channels) to view further audio selection options, if these are transmitted by the channel provider. Use the   buttons to scroll through the available selection options. Press the  (yellow) button again, or press the  button to exit this display again.



ERROR SIGNALLING

“Weak or no signal” indicates that an error has occurred in the reception system or in the receiver settings, or that the transponder is not transmitting.

Check the Sat IF connection and the LNB configuration. If you have changed settings, compare them against the basic settings (provided you had made a note of them as suggested).

CHANNEL LIST – TV/RADIO

Also pay attention to the bars at the bottom of the on-screen display! These provide information on what to do next.



Press the  button to access the channel list.

When you open this list the channel list selection / sort order is displayed from where you selected the last channel.









At the top left you will see the selected channel list (TV Channel or Radio Channel) displayed.

Press the  (blue) button to switch between the TV and radio channel lists.



ON-SCREEN DISPLAYS (OSD)

Underneath you can see the channel list with the sort order you selected. The channel list can display channels sorted by various selection and sorting criteria.

Selection and sorting options:

- Press the  (red) button to open the favourites list selection. The   buttons allow you to scroll through the existing favourites lists
- Press the  (green) button to return to the overall list (all satellites). Use the   buttons to choose between the received satellites (display all channels from a satellite) and the list of "New channels" (provided by channel search).
- Press the  (yellow) button to see an alphabetic listing. This list displays all the channels sorted alphabetically, or the ones beginning with the selected initial letter. Use the   buttons to make the selection.

Search function:



- Press the  button to start the search. The numeric pad buttons allow you to input the desired search expression for the channel that is sought (see also "Operating instructions", "Alphanumeric input"). Press the  button to start the search (see screenshot below for an example of a search result)

Press  to view the following items of information on a channel (see screenshot on the right as an example):

- Signal strength
- Signal quality
- Transmitting satellite
- Frequency (MHz)
- Polarisation
- Symbol Rate

The cursor buttons  are used to navigate within the respective channel





list view to select the desired channel. The selection of the desired channel is confirmed by pressing the  button. You will now hear and see the currently selected channel in the small window at the top right. To exit the channel list and return to the TV picture, press the  button again, or press the  button.

EPG - ELECTRONIC PROGRAMME GUIDE

CALLING UP THE EPG

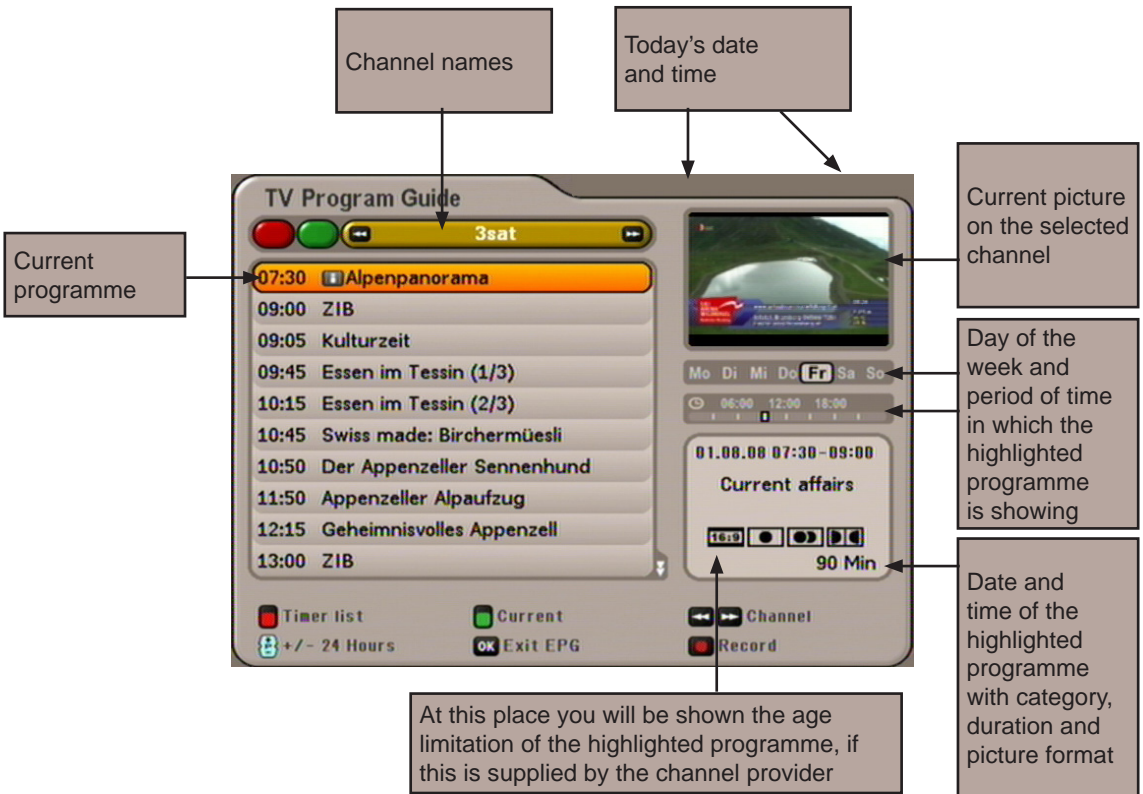









The EPG is opened by pressing the  button. Each time the EPG is opened, you will automatically be shown the "Current" view, irrespective of which view you were shown the last time you left the EPG. The following display appears (example):







Note: If you selected a favourites list before opening the EPG, you will see in the EPG only the data for the channels that are included in this favourites list. Press the  button again to display the EPG for all channels.

EPG - ELECTRONIC PROGRAMME GUIDE

Selection options:

-  (red) button Open the timer list (display of all pre-programmed recordings)
-  (yellow) button Open the "EPG" view
-  (green) button Open the "Current" View
-  button Changing the channel in the "EPG" view
-  button Next programme in the "Current" view
-  button (P+) jump forwards 24 hours in the EPG,
(P-) jump backwards 24 hours
-  button Select the currently highlighted channel in all views. Pressing the  or the  button again closes the EPG and the selected channel is shown again on the TV screen
-  (red dot) button Add a programme to the recording settings
-  button Show, if present, further information on the selected programme.

Navigation within each view is always performed using the cursor buttons (). The  buttons allow you to select individual channels/programs, and the  buttons allow you to scroll from page to page of the currently selected list.

Pressing the  or the  button exits the EPG again and returns to the TV picture.





You see information on the current or next following programmes in the EPG only if it is supplied by the channel provider.



"CURRENT" VIEW

The "Current" view can be called up at any time in EPG by pressing the  (green) button.

In the "Current" view you see all channels displayed in the order of the overall channel list. Provided that EPG data has been supplied by the channel provider, the receiver shows for each channel the current programme being shown, with start time, finish time, and progression bar.

You can use the cursor buttons () to select the desired programme and if available you can use the  button to call up further information on the desired programme.

EPG - ELECTRONIC PROGRAMME GUIDE

Pressing the  button displays the next programme ("Next" view); pressing the  button returns you to the "Current" view.

If you wish to view the programme currently being shown on a channel, you need not exit the EPG, just select the desired channel. At the top right of the screen you will see the current TV picture for the selected channel.



"PREVIEW" VIEW (PROGRAMME LISTINGS)



The "Coming up" view (programme listings) can be called up at any time in EPG by pressing the  (yellow) button.

Also pay attention to the bars at the bottom of the on-screen display! These provide information on what to do next.



In the "Coming up" view you will see all the programmes that will be shown in the previous "Current" list of selected channels. Provided that EPG data has been supplied by the channel provider, the receiver displays the programmes that will be shown on the selected channel for several days in advance.

You can use the cursor buttons () to select the desired programme and, if available, you can use the  button to open further information on the desired programme.

Using the   buttons you can scroll through the channels in their sequence in the overall channel list. You remain however within the "EPG" view at all times.

The  button allows you to scroll backwards and forwards a day at a time.

Using the  (red dot) button you can load the selected programme into the recording settings (see "Recording" section).

EPG - ELECTRONIC PROGRAMME GUIDE



ADDITIONAL INFORMATION (i BUTTON)

The additional information can always be called up by pressing

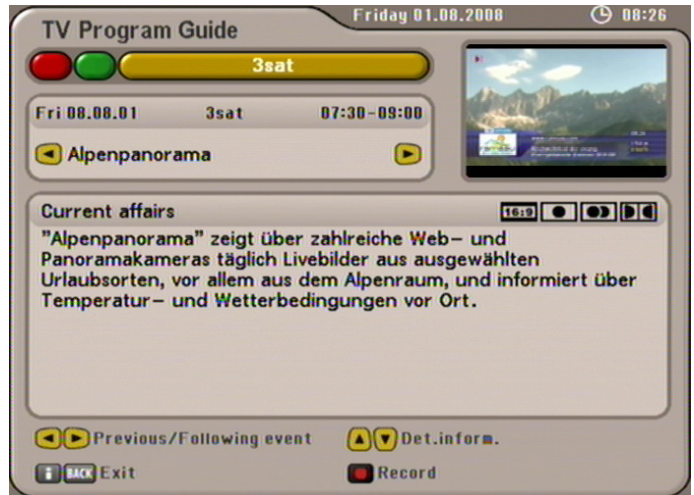

the  button whenever the "i symbol" appears in front of the programme name (see screenshot on the right). First however the channel must be selected. The following display appears (example):



The additional information available for a programme is displayed in its own window. By pressing the  button, if available, you can open further additional information on the selected programme.

The   buttons enable you to display the additional information for the preceding or following programmes in the order of the previously selected list (see header). This feature always assumes that the data has been supplied by the channel provider.

Using the  (red dot) button you can load the selected programme into the recording settings (see "Recording" section).

Press the  or  button to drop the additional information.

EPG - ELECTRONIC PROGRAMME GUIDE

RECORDING (TIMER)

The  (red dot) button allows you to set up a programme at any time for recording on an external recorder.

The programme to be recorded can be selected in any of the EPG views, provided the  (red dot) button appears at the bottom of the screen display.



If the programme is present in the EPG:

Select the desired programme and press the  (red dot) button. The following display appears (see example picture below):

Programme not present in the EPG:

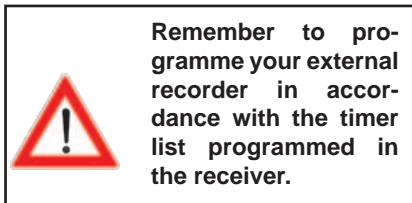
Select any programme on the channel on which the desired programme is to be transmitted at a later time and press the  (red dot) button (starting and finishing times together with the recording date must be input manually). The following display appears (example):



Use the   buttons to select the desired recording mode. The following recording mode options are available:



- **once:** The recording will be performed once
- **daily:** The recording will be performed daily at a time specified by you
- **weekly:** The recording will be performed once a week on the same day and at the same time





Use the cursor buttons  to select the further items and use the keypad to complete the settings. When

all settings have been made, press the  button to save the recording settings. You can view the scheduled recordings in the timer list view of the EPG (see section "Timer list").

EPG - ELECTRONIC PROGRAMME GUIDE

RECORD ONCE

Use the   buttons to select the recording mode "once" (see screenshot "Recording (timer)" section).

Use the   buttons to switch to the selection field "Date" and use the   buttons to select the desired recording day.





Use the   buttons to switch to the selection field "Start" and use the   buttons or the number pad buttons to select the desired recording start time.

Use the   buttons to switch to the selection field "Duration" and use the   buttons or the numeric pad buttons to select the desired recording length.



When all settings have been made, press the  button to save the recording settings. You can view the scheduled recording in the timer list view of the EPG (see section "Timer list").

RECORD DAILY

Use the   buttons to select the recording mode "daily" (see screenshot below).

Use the   buttons to switch to the selection field "Start" and use the   buttons or the number pad buttons to select the desired recording start time.

Use the   buttons to switch to the selection field "Duration" and use

the   buttons or the numeric pad buttons to select the desired recording length.



When all settings have been made, press the  button to save the recording settings. You can view the scheduled recording in the timer list view of the EPG (see section "Timer list").

EPG - ELECTRONIC PROGRAMME GUIDE



RECORD WEEKLY



Remember that the day of the week for the desired programme is loaded in the recording list and you can make no further manual corrections to it! Therefore before pressing

the  (red dot) button, select the programme on the day of the week that in future you will wish to make the weekly recording.

Use the   buttons to select the recording mode “weekly” (see screenshot below).

Use the   buttons to switch to the selection field “Start” and use the   buttons or the number pad buttons to select the desired recording start time.

Use the   buttons to switch to the selection field “Duration” and use the   buttons or the numeric pad buttons to select the desired recording length.



When all settings have been made, press the  button to save the recording settings. You can view the scheduled recording in the timer list view of the EPG (see section “Timer list”).



EPG - ELECTRONIC PROGRAMME GUIDE

PLAN RECORDING

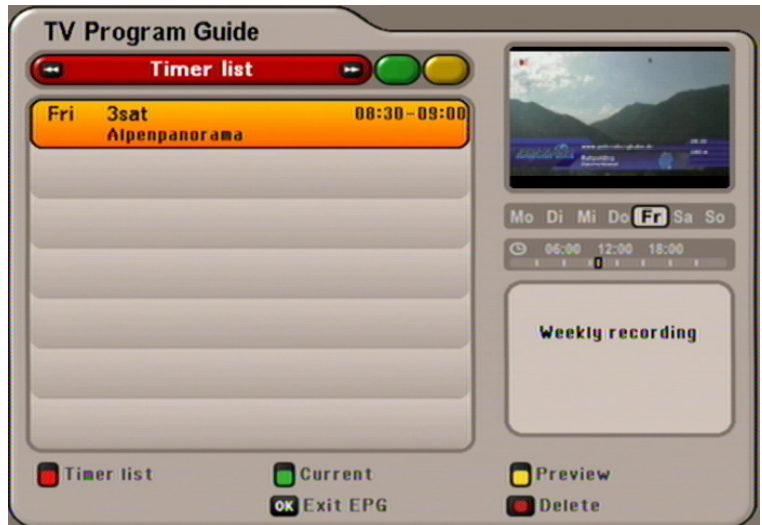
The "Recording schedule" view can be called up at any time in EPG by pressing the  (red) button.



The timer list view shows you all the recordings that are scheduled.

The   buttons allow the recordings to be sorted into "once" or "repeated" recordings.

The cursor buttons () allow you to select a recording.

The  (red dot) button allows you to delete a recording that had been scheduled.

VIDEOTEXT (TELETEXT)

This symbol  in the channel notification shows you whether Videotext/Teletext is available for the selected channel.

When you press the  button, the receiver processes the videotext/Teletext service data for your TV set to display, even when the signal is encrypted.



When the search is finished, the videotext/Teletext being broadcast by the relevant encrypted provider appears:

You have several options for opening the desired pages:

- Input with numeric pad.
- Scroll backwards and forwards using the   buttons
- Selection using the options indicated by the coloured buttons  (red),  (green),  (yellow) and  (blue) listed across the bottom of the screen

Press  or  to exit Videotext/Teletext.

EDIT CHANNEL LIST

Select the "Edit channel list" menu using the  button, the   buttons on the main menu and .

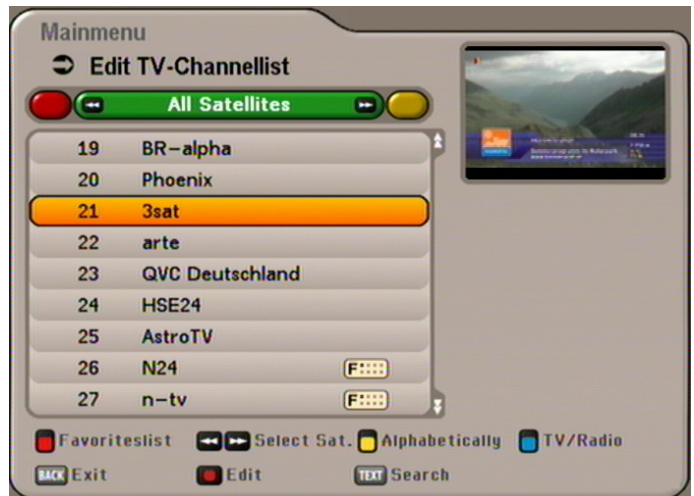

Also pay attention to the bars at the bottom of the on-screen display! These provide information on what to do next.





Press the  button to close the information display for editing channels and channel lists. When the menu is opened, the standard setting is for the receiver to show the "All Satellites" channel list with all channels available on the satellites that are being received.







SELECTION OF THE LIST / CHANNELS TO BE EDITED

Press the  (blue) button to switch between the TV and radio channel lists. Radio channels are edited in the same way as TV channels.

Editing favourites lists is explained as a separate item.

Selection options:

-  (blue) button Switch between radio and TV channels
-  (green) button Open satellite channel lists
-  (yellow) button Open the channel lists, sorted alphabetically
-  button Search for a specific channel (input the search expression using the numeric pad on the remote control, see also the sections "Operating instructions", "Alphanumeric input")

The channel list chosen is generally that sorted by categories (satellites, favourites and alphabetic) using the   buttons (the standard list shown on calling up is the "All Satellites" channel list). Selection of channels in the list is performed using the cursor buttons (). The   buttons allow you to select individual channels, and the   buttons allow you to scroll from page to page of the currently selected list.

EDIT CHANNEL LIST

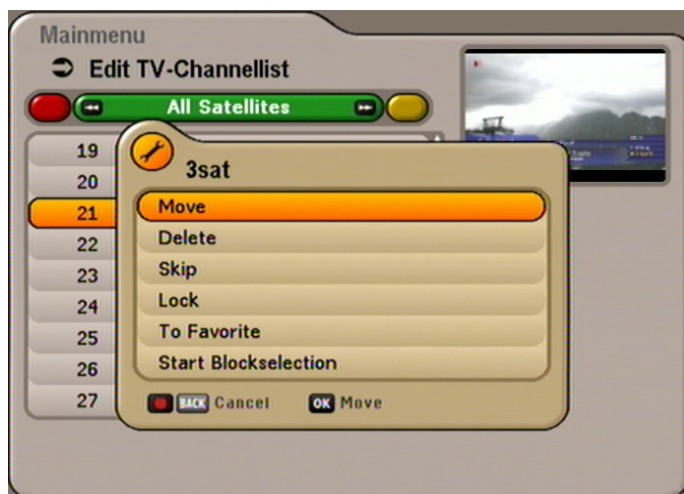

EDITING LISTS / CHANNELS



When you have selected the channel or channel list to be edited, press the  (red dot) button to open the edit menu. You have the following edit options:



- **Move:**
Channel can be moved within the current list to another channel slot
- **Delete:**
Delete the channel from the current list
- **Skip:**
Channel will be skipped when zapping through the channels
- **Lock:**
Channel can be viewed only by entering a PIN
- **To favorite:**
A channel can be assigned to any Favourites List
- **Start Blockselection:**
Several channels can be selected at the same time and edited together













As soon as you exit the menu under which you made the edit changes, you will be asked if you wish to save the changes. Use the   buttons to select either "Yes, save changes" or "No, don't save changes". Confirm your selection with the  button.

EDIT CHANNEL LIST







“LAST FUNCTION” MEMORY

The last editing action performed is saved on the  button, so by pressing the  button you can apply the last selection to other channels without having to open the edit menu again. As soon as you leave the current display, this option is cleared and becomes available again only after the edit menu has been opened and an action selected.

MOVE CHANNELS

Use the   buttons to select the channel to be moved from the current channel list (use the  (green) button to switch to the overall list, use the  (yellow) button to switch to the alphabetically sorted list). Press the  button to open the edit menu and use the   buttons to select the “Move” function. Confirm the command by pressing the  button. The channel you previously selected will now be shown inset slightly from the left. Now use the cursor buttons () or the number buttons to select the new desired position for the channel, and confirm the new channel slot by pressing the  button.

DELETE CHANNELS







Use the   buttons to select the channel to be deleted from the channel list you have selected. Press the  button to open the edit menu and use the   buttons to select the “Delete” function. Confirm the command by pressing the  button.



A deleted channel can be recovered only by performing another channel search (see section “Channel Search”)!

The channel you previously selected will be deleted (from the favourites lists also!).







SKIP CHANNELS

Use the   buttons to select the channel to be skipped from the current channel list. Press the  button to open the edit menu and use the   buttons to select the “Skip” function. Confirm the command by pressing the  button.

The channel you previously selected is now shown in grey text. When zapping the channels this channel will in future be skipped and no longer shown in the channel list (called up using the  button). This function can be restored again using the edit menu (select: “Unskip”).

EDIT CHANNEL LIST









LOCK CHANNELS

Use the   buttons to select the channel to be locked on the channel list you have selected. Press the  button to open the edit menu and use the   buttons to select the "Lock" function. Confirm the command by pressing the  button. You are now prompted to enter the PIN code (factory default setting: 0000).

The channel you previously selected is now shown with a padlock to its right. In future this channel can be viewed only by entering the four-digit PIN code.

This function can be restored again using the edit menu (select: "Remove lock").







COPY CHANNELS TO THE FAVOURITES LIST



Use the   buttons to select the channel to be copied from the current channel list. Press the  button to open the edit menu and use the   buttons to select the "To favorite" function. Use the   buttons to select the favourites list to which the channel is to be copied. The channel remains in the satellite channel list. Confirm the command by pressing the  button.

The channel you previously selected is now shown with an "F" and a yellow field in the channels list. The "F" shows that it is a favourite channel; the black dot in the yellow field shows in which of the eight favourites lists the channel can be found.

See the item "Editing Favourite Lists" for information on how to delete a channel from a favourite list.

START BLOCKSELECTION (HIGHLIGHTING SEVERAL CHANNELS)

Use the   buttons to select the channel from which you want to highlight further channels. You can only select channels that are listed in succession in the channel list you have selected. Press the  button to open the edit menu and use the   buttons to select the "Start Blockselection" function. Use the   buttons to highlight the desired channels, starting from the previously highlighted channel and working upwards or downwards. The highlighted channels will be highlighted in yellow and marked with a tick on the left.





When you have highlighted the channels that you wish to select, press the  button to open the edit menu once again and use the   buttons to select the desired function ("Move", "Delete", "Skip", "Lock" or "To Favorite").

The selected function can now be used in the same way as described for the respective items in this section for a single channel.

EDIT CHANNEL LIST





EDIT FAVOURITES LISTS



When you have selected the favourites list to be edited (called up using the  (red) button and selected using the   buttons), press the  (red dot) button to open the edit menu. You have the following edit options:

- **Remove from favorites list:**
The channel will be removed from the favourites list
- **Lock:**
Channel can be viewed only by entering a PIN
- **Rename favorites list:**
The favourites list can be renamed
- **Start Blockselection:**
Several channels can be selected at the same time and edited together





REMOVE FROM THE FAVOURITES LIST

Use the   buttons to select the channel to be removed from the favorites list you have selected. Press the  button to open the edit menu and use the   buttons to select the "Remove from favourites list" function. Confirm the command by pressing the  button.

The channel you previously selected is now removed from the favourites list (but not deleted from the overall satellites list).

EDIT CHANNEL LIST

LOCK CHANNELS







Use the   buttons to select the channel to be blocked in the favourites list you have selected. Press the  button to open the edit menu and use the   buttons to select the “Lock” function. Confirm the command by pressing the  button. You are now prompted to enter the PIN code (factory default setting: 0000).

The channel you previously selected is now shown with a padlock to its right. In future this channel can be viewed only by entering the four-digit PIN code.







The channel is also locked on all other channel lists. You need not additionally lock the channel in the other channel lists.



This function can be restored again using the edit menu (select: “Remove lock”).

RENAME FAVOURITES LIST

Use the   buttons to select the favourites list to be renamed. Press the  button to open the edit menu and use the   buttons to select the “Rename favorites list” function. Confirm the command by pressing the  button. A keypad will now be displayed with which you can enter the desired name alphanumerically using the numeric pad on the remote control. See also the section “Operating Instructions”, “Alphanumeric Input”.

START BLOCKSELECTION (HIGHLIGHTING SEVERAL CHANNELS)

Use the   buttons to select the channel starting from which you want to highlight further channels. You can only select channels that are listed in succession in your selected favourites list. Press the  button to open the edit menu and use the   buttons to select the “Start Blockselection” function. Now use the   buttons to highlight the desired channels, starting from the previously highlighted channel and working upwards or downwards. The highlighted channels will be highlighted in yellow and marked with a tick on the left.

When you have highlighted the channels that you wish to select, press the  button to open the edit menu once again and use the   buttons to select the desired function (“Remove from favorites list”, or “Unlock”).

The selected function can now be used in the same way as described for the respective items in this section for a single channel.

SEARCH CHANNELS (CHANNEL SEARCH)

Select the "Channel search" menu using the **MENU** button, the **▲** **▼** buttons in the main menu and **OK**.

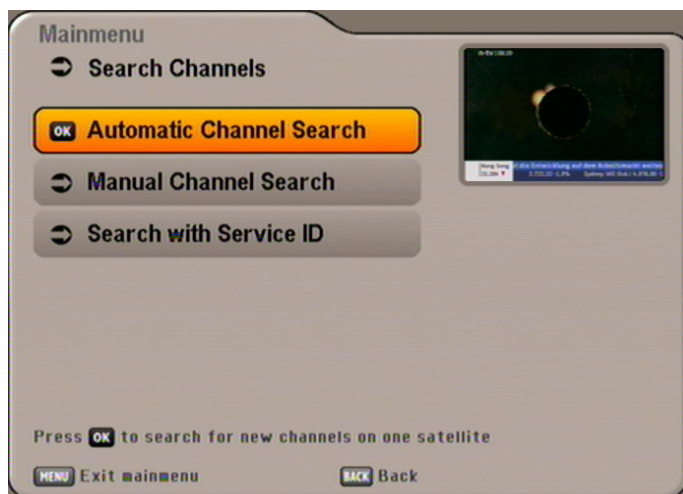

Also pay attention to the bars at the bottom of the on-screen display! These provide information on what to do next.

You have three options for a channel search.

- Automatic Channel Search – all transponders for the satellite you selected will be searched
- Manual Channel Search – only the selected transponder for the satellite you selected will be searched
- Channel search with service ID - Search for a specific channel using its service ID

Use the **▲** **▼** buttons to select the desired type of search and confirm your selection using the **OK** button.

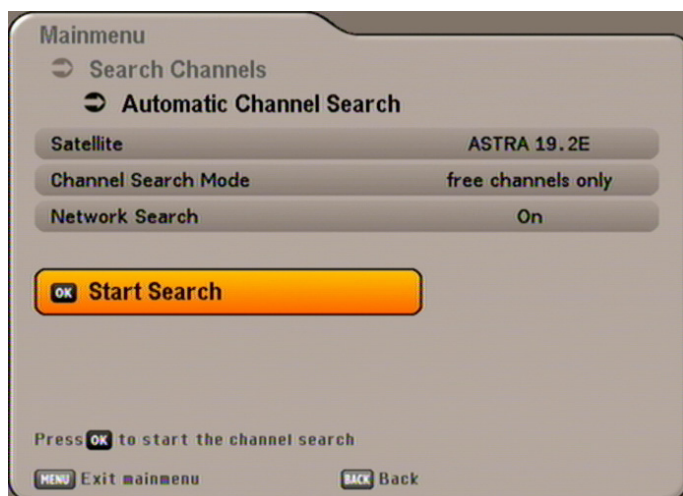

AUTOMATIC (CHANNEL) SEARCH



The **▲** **▼** buttons allow you to select different sets of parameters for the scan.



SEARCH CHANNELS (CHANNEL SEARCH)

Satellite

Using the   buttons, select the satellite to be scanned. Make sure your reception system is aligned to the selected satellite. You can search only one satellite at a time. If you have connected a multi-feed reception system (e.g. reception of ASTRA 19.2° East and HOTBIRD 13° East), you must repeat this procedure once for each satellite. You can however start the first installation again, in the course of which a channel search of all the satellites you selected is performed.



Press the  button to move to the next selection item.

Channel Search Mode



Use the   buttons to select whether you wish to search “free & encrypted” or “only free” channels.

Press the  button to move to the next selection item.

Network Search

Use the   buttons (On/Off) to select whether a network scan should be performed. If you set the network search to “Off”, only the factory stored transponders of the satellites you previously selected will be searched for new as yet unlisted channels.

If you set the network scan to “On”, the transponder network enables additional transponders that have not yet been stored to be located. They are then stored and searched for new channels in the same way as the existing transponders.

When you have made your settings, use the   buttons to select “Start Search” and press the  button to start scanning. You can cancel the scan at any time by pressing the  button. During the search you will see the following message (example):

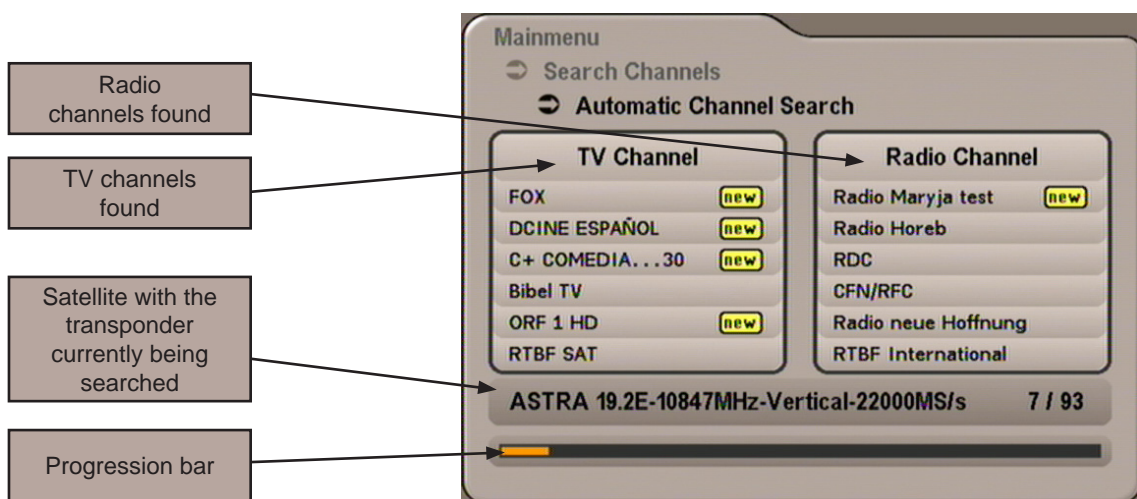

SEARCH CHANNELS (CHANNEL SEARCH)

Newly found channels are identified with the designation “New” after the channel name. After completion of the search, you will see the following message (example):

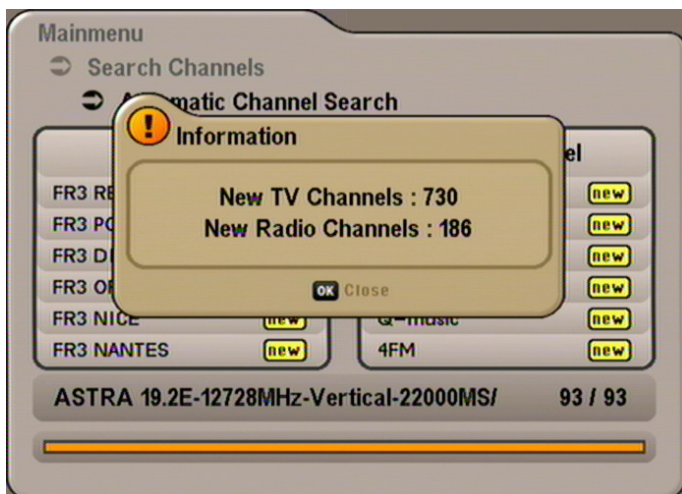

Press the **OK** button. You will be asked whether you wish to save the changes or not. Use the **▲** **▼** buttons to make the selection and confirm with the **OK** button. If you select “Yes, save changes”, the newly found channels will be added to the end of the channel list. Then press the **BACK** button to exit the menu. The channel list is opened on to the TV screen by pressing the **OK** button (see also section “On-screen displays” “Channel list TV/Radio”).





After a scan (of whatever type) the receiver shows all newly found channels in the channel list under the rubric “New Channels”. You will find this rubric in the channel list at the end of the green satellite channel lists (select using the **◀** **▶** buttons).

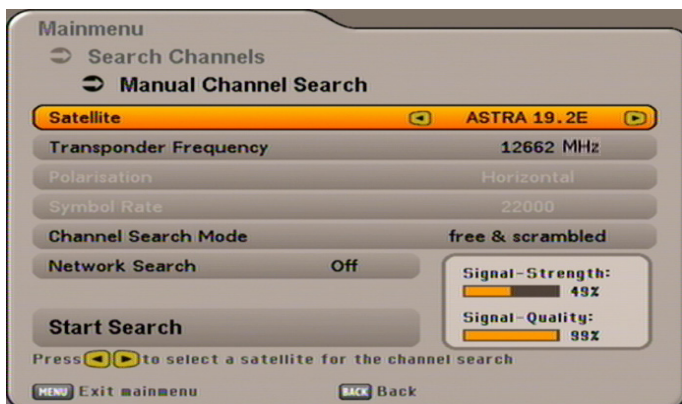

MANUAL (CHANNEL) SEARCH



SEARCH CHANNELS (CHANNEL SEARCH)

The   buttons allow you to select different sets of parameters for the scan.

Satellite

Use the   buttons to select the satellite on which the transponder you wish to scan is located. Make sure your reception system is aligned to the selected satellite. You can search only one transponder at a time. If you wish to search several transponders on a satellite, you should start an automatic search of the transmitting satellite.



Press the  button to move to the next selection item.

Transponder frequency

Select the transponder to be scanned, using the   buttons or the keypad. At the bottom right of the screen display, the receiver shows the current signal strength and signal quality of the selected transponder.



Press the  button to move to the next selection item.

Channel Search Mode





Use the   buttons to select whether you wish to search “free & encrypted” or “only free” channels.

Press the  button to move to the next selection item.

Network Search

Use the   buttons (On/Off) to select whether a network scan should be performed. If you set the network search to “Off”, only the factory stored transponders of the satellites you previously selected will be searched for new as yet unlisted channels.

If you set the network scan to “On”, the transponder network enables additional transponders that have not yet been stored to be located. They are then stored and searched for new channels in the same way as the existing transponders.

When you have made your settings, use the   buttons to select “Start Search” and press the  button to start scanning. You can cancel the scan at any time by pressing the  button.

During the search you will see a display that shows you the progress of the search and the channels found so far. Newly found channels are identified with the designation “New” after the channel name.

SEARCH CHANNELS (CHANNEL SEARCH)

After completion of the search, you will see the following message (example):

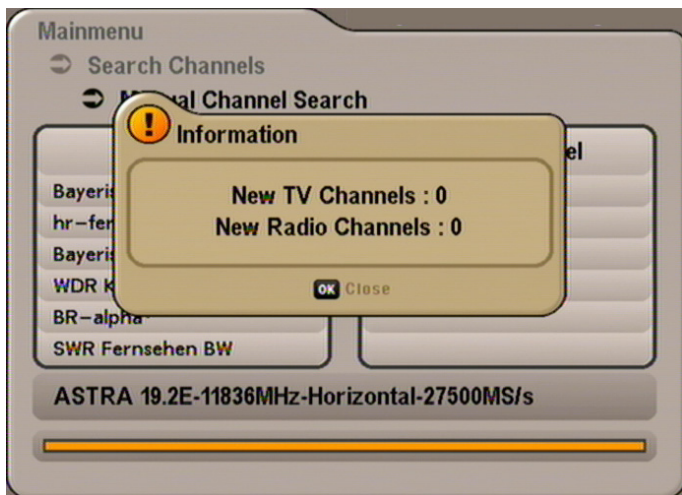

Press the **OK** button. You will be asked whether you wish to save the changes or not. Use the **▲** **▼** buttons to make the selection and confirm the selection with the **OK** button. If you select "Yes, save changes", the newly found channels will be added to the end of the channel list. Then press the **BACK** button to exit the menu. The channel list is opened on to the TV screen by pressing the **OK** button (see also section "On-screen displays" "Channel list TV/Radio").

CHANNEL SEARCH WITH SERVICE ID

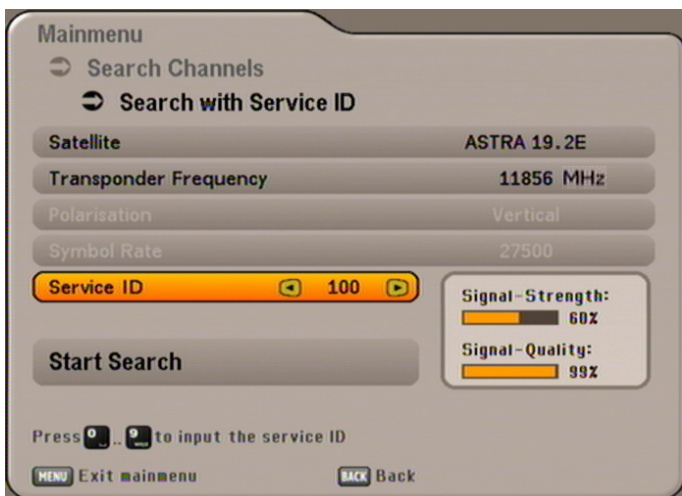

The **▲** **▼** buttons allow you to select different sets of parameters for the scan.

Satellite



Use the **◀** **▶** buttons to select the satellite that is transmitting the channels to be scanned.

SEARCH CHANNELS (CHANNEL SEARCH)

Make sure your reception system is aligned to the selected satellite.



Press the  button to move to the next selection item.



Transponder frequency

Use the   buttons or the keypad to select the transponder frequency on which the channel being sought is transmitted. At the bottom right of the screen display, the receiver shows the current signal strength and signal quality of the selected transponder.

Press the  button to move to the next selection item.

Service ID





Using the   buttons or the keypad, enter here the service ID of the channel being sought.

When you have made your settings, use the   buttons to select "Start Search" and press the  button to start scanning. You can cancel the scan at any time by pressing the  button.

During the search you will see a display that shows you the progress of the search.





After completion of the search, you will see the following message (example):



Press the  button. You will be asked whether you wish to save the changes or not. Use the   buttons to make the selection and confirm the selection with the  button. If you select "Yes, save changes", the newly found channels will be added to the end of the channel list. Then press the  button to exit the menu.

The channel list is opened on to the TV screen by pressing the  button (see also section "On-screen displays" "Channel list TV/Radio").

PARENTAL CONTROL

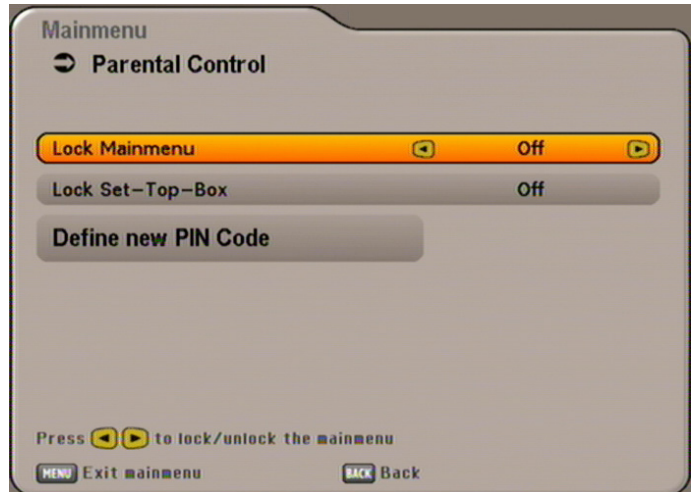

Select the "Parental Control" menu using the menu button , the   buttons on the main menu and . You are now prompted to enter the PIN code (factory default setting: 0000). After entering the PIN using the keypad you are shown the following display:





Also pay attention to the bars at the bottom of the on-screen display! These provide information on what to do next.

Select the parameters to be changed using the   buttons.

LOCKING MAIN MENU

Use the   buttons (On/Off) to select whether the main menu should be blocked. If the menu is locked, changes can be made only by entering the four-digit PIN code.

LOCK SET-TOP-BOX

Use the   buttons (On/Off) to select whether the receiver should be blocked. If the receiver is locked, it can be operated only by entering the four-digit PIN code after it is switched on (factory setting: 0000).

Press the  button to exit the menu again.

PARENTAL CONTROL

DEFINE NEW PIN CODE

Press to replace the old PIN with a new one. Enter the new (four digit) PIN. For security you must repeat the new PIN code once again. Confirm the change of PIN code by pressing the button.



Keep your PIN code in a safe place, so that you always have access to your channels should you ever forget it.

If you have forgotten your PIN code, you must contact your dealer, who will be able to unlock your receiver for you.

SETTINGS

The selected menus, sub-menus and positions, as well as the parameters to be set, are each highlighted in colour. The menus are largely self-explanatory.

Pay attention to the bar at the bottom of the on-screen display. These provide information on what to do next.

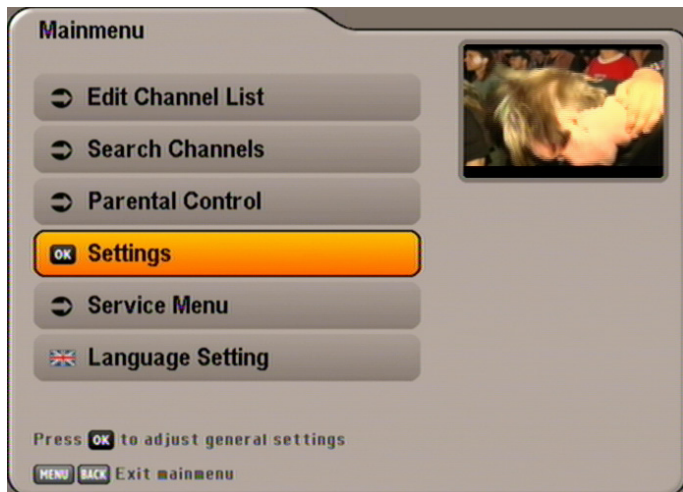

Select the "Settings" menu using the **MENU** button, the **▲** **▼** buttons in the main menu and **OK**.

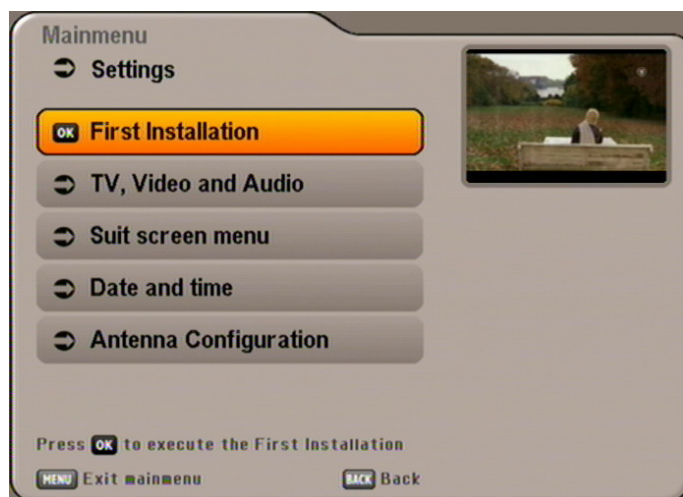

Press **OK** to open the "Video and Audio" menu. The following display appears (see next page):

Use the **▲** **▼** buttons to select the further options. If there is another sub-menu layer, press the **OK** button to open it. If there are no more sub-menus, make the settings using the  or numeric pad.



Press the **BACK** button to save your settings and return to the previous menu. Press the **MENU** button to return directly to the TV picture, the changes will also be saved.

SETTINGS

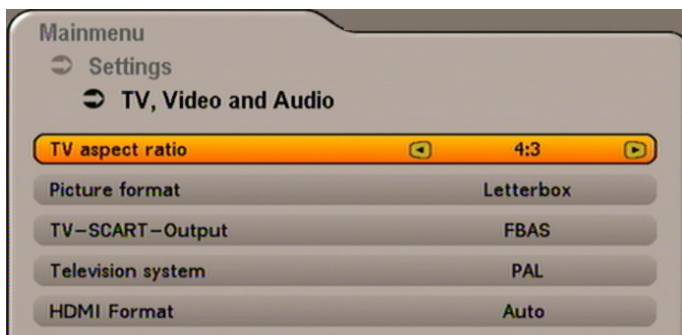
TV SETTINGS (TV, PICTURE AND SOUND)



TV ASPECT RATIO

Here you can use the   buttons to select the picture format for your TV. Either



4:3 or
16:9 format.

PICTURE FORMAT

Use the   buttons here to select the type of screen display.

- Pan & Scan
- Letterbox
- Full-screen image

TV-SCART-OUTPUT

Here you can use the   buttons to select the type of video signal at the TV Scart socket. Select the signal that your TV set can process. **When doing this, refer to the operating instructions for your TV set!**

- Composite baseband signal
(Colour Video Baseband Signal) or
- RGB - Red/Green/Blue signal

TELEVISION SYSTEM

Here you can use the   buttons to specify whether your TV set is a

- PAL or
- NTSC set.

HDMI FORMAT

Here you can use the   buttons to set the picture format to be transmitted to your TV set via HDMI

Available options: "Auto" (automatic format choice), 576p, 720p or 1080i

SETTINGS

CUSTOMIZE SCREEN MENU



FUNCTIONAL RANGE

Here you can configure the functional scope of your receiver. You can choose between “Complete”, “Simple” and “Medium”. The following table shows which functions are available at each configuration step.

	- (red) button	- (yellow) button	- (blue) button	button	button
High	Select favourites	Select options	TV/Radio	AV changeover	Channel list
Low	Not assigned	Not assigned	Not assigned	Not assigned	Programme Guide
Normal	Select favourites	Select options	TV/Radio	Not assigned	Programme Guide

CHANNEL OSD DURATION

Use the buttons to select the time after which you want the on-screen channel message display to be automatically cancelled. The selections available are “Off”, 1, 2, 3, 4, 5 or 6 seconds.

ADJUST MENU ON TV

Press the button to align the on-screen displays on the TV screen. Now you can

use the cursor buttons (, , ,) to determine the position of the on-screen display. When you have achieved the desired

position, press the button to fix the desired position.

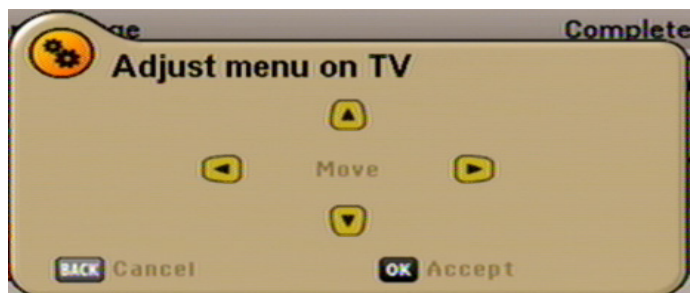

SETTINGS

DATE AND TIME

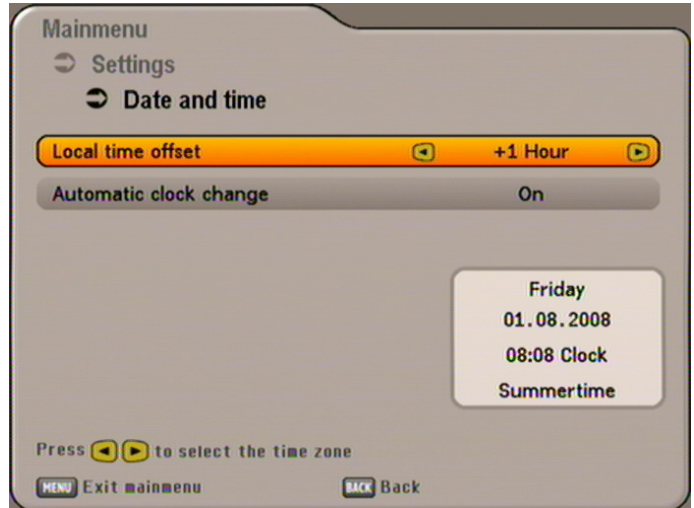

Local time offset

Use the [left arrow] [right arrow] buttons to set the time zone variation from UTC (formerly GMT) (e.g. for Germany +1 hour).

Use the [up arrow] [down arrow] buttons to switch to the "Automatic clock change" field.

Automatic clock change

Use the [left arrow] [right arrow] buttons to select whether the receiver should automatically change over to and from summer and winter time. If "On" is selected, the receiver automatically sets itself to the right time. If "Off" is

selected, the field for manual selection of summer and winter time is displayed below. The [left arrow] [right arrow] buttons are also used to perform the setting.

Press the [BACK] button to exit the menu again.

COMMON INTERFACE

See "Common Interface" section

ANTENNA CONFIGURATION

See "First Installation" section, pages 15ff

SERVICE MENU

Select the "Service" menu using the **MENU** button, the **▲▼** buttons in the main menu and **OK**. The following display appears:

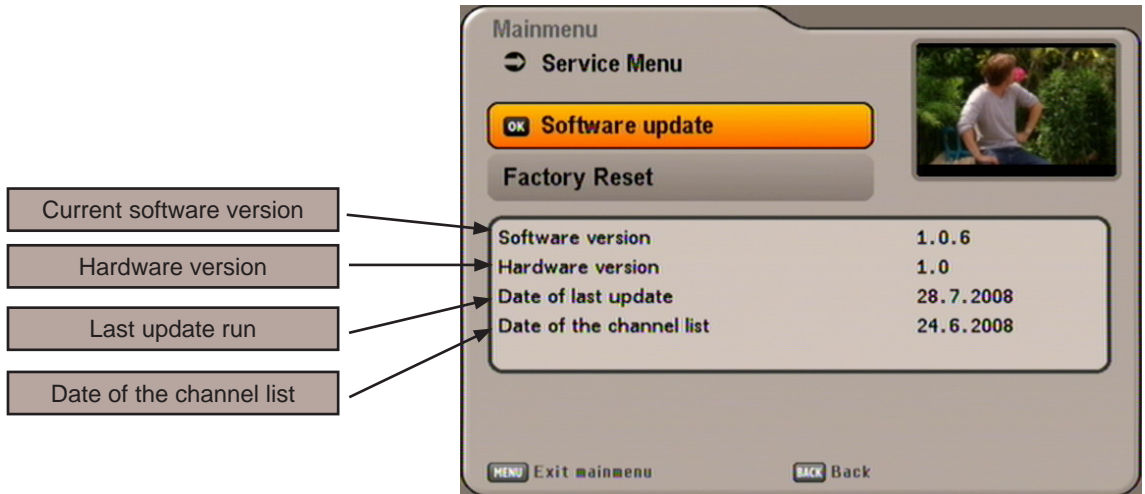

UPDATING SOFTWARE

You can also check manually whether new software is available.

Use the **▲▼** buttons to switch to "Software Update" and to call it up press the **OK** button. The following display appears:

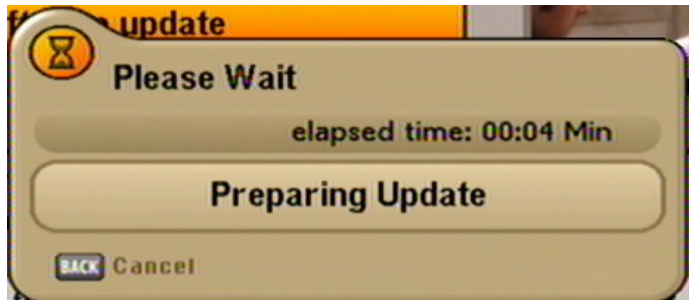



SERVICE MENU

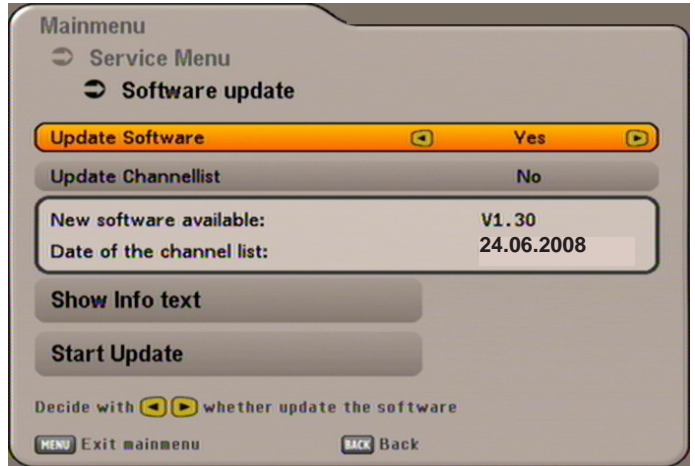

Also pay attention to the bars at the bottom of the on-screen display! These provide information on what to do next.



Updating software

If new software is available (but only then), use the   buttons (No/Yes) to select whether you wish to load the new software that is available. If you are unsure whether you wish to load the new software, you can initially set the reply to “No”. If you do agree to the changes, you can then proceed to download the software.

Channel list

If a new channel list is available (but only then), use the   buttons (No/Yes) to select whether you wish to load the new channel list that is available.

When you have made your settings, use the   buttons to select “Start Update” and press the  button to start updating.

SERVICE MENU

The following display appears (example):

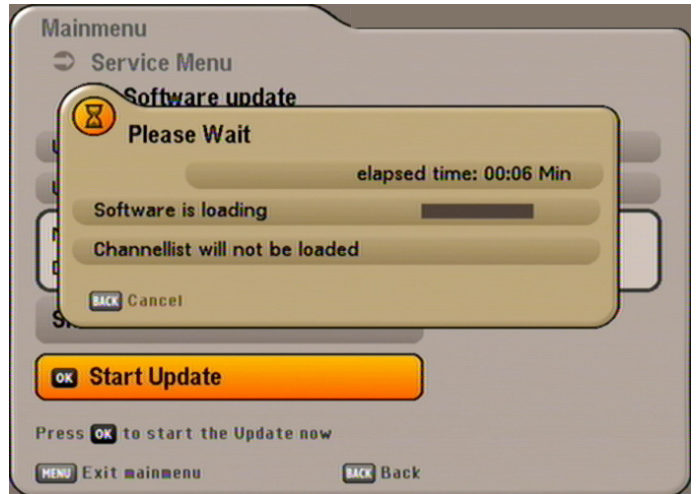

RESTORE FACTORY SETTINGS

Select the "Service" menu using the **MENU** button, the **▲** **▼** buttons in the main menu and **OK**. Use the **▲** **▼** buttons to switch to "Restore factory settings" and to call them up press the **OK** button. The following display appears:

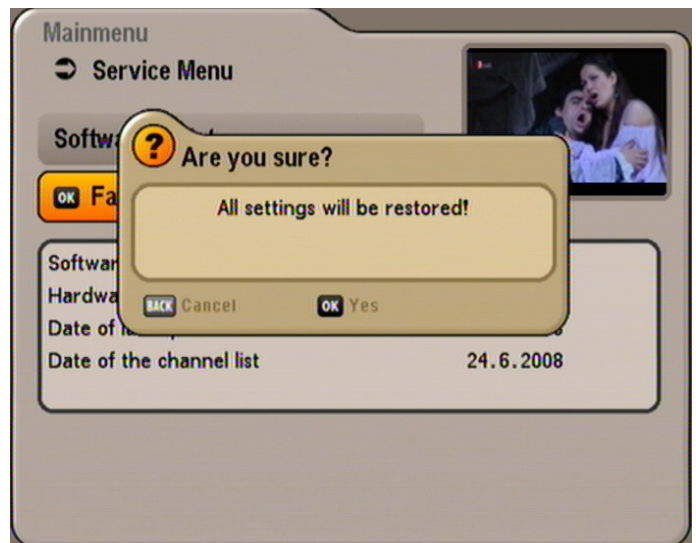

Press the **OK** button to load the factory settings. The channels and favourites lists remain unchanged.

CONNECTING UP THE VIDEO/DVR

For details of how to connect your external recorder to the receiver refer to the connection diagram provided at the end of this manual and the instructions for the external recorder.

RECORDING

In order to make a VCR recording (Record), the satellite receiver must be switched on or the timers must be pre-programmed (see "EPG" "Recording (timer)" section).

PLAYBACK

For VCR/DVR playback you must have previously set the UFS 650 Scart socket to "VCR mode" (Scart changeover), using the  button, so that the signal path is set up from the VCR or DVR/AUX Scart socket to the TV Scart socket.

In this setting, the picture from the external recorder is switched through to the TV set during playback.

Pressing the  button again restores priority to the signal from the UFS 650 "Scart>Sat". The settings "Scart>VCR" and "Scart>Sat" are shown in the display of the receiver.

USING THE FRONT PANEL/SERVICE

If you have misplaced your remote control, or if the batteries are flat, you can still operate your receiver from the front panel.

BACKUP OPERATION

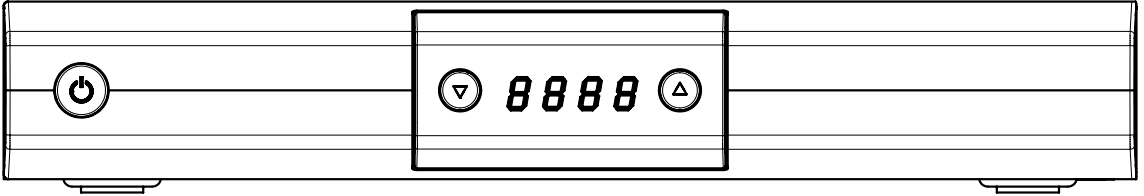

There are two buttons on the front of the receiver.

▼ button:

The channel down button switches to the next channel down in the currently selected channel list.

▲ button:

The channel up button switches to the next channel up in the currently selected channel list.



Because there are no numbered buttons, no password/PIN-protected functions can be displayed.

SERVICE

If, despite studying this operating manual, you still have questions about getting started with the unit or using it correctly, or if unexpected problems occur, please contact your specialist dealer.

TECHNICAL APPENDIX

FEATURES

- Reception of digital satellite TV and radio programmes
- HDMI output enables connection to a flat-screen TV set for optimal viewing comfort
- Upscaler to upscale Pal signals (576i) to 576p, 720p and 1080i
- 4-digit display
- Kathrein EPG with timer programming ¹⁾
- Guided first installation with national programme lists
- Pre-programmed programme list
- Suitable for software downloads via satellite and PC
- 8 favourite programme lists each for TV and radio
- On-screen display (OSD) in 8 languages (D, GB, F, I, E, CZ, NL, TR)
- 14 timers; convenient programming via EPG
- Language selection for programmes broadcast in several languages
- Electrical audio output for Dolby Digital data stream (AC 3)
- Composite colour picture and RGB signal output programmable on Scart socket
- Cinch sockets for AV signal
- Videotext decoder with 800-page memory capacity and videotext generation
- Automatic 4:3 and 16:9 format recognition with optional output format
- Automatic date and time setting via DVB data stream
- Programme position sort function
- DiSEqC™1.0 and SCR single-cable system control signals
- Infra-red remote control
- On/off switch (disconnection from 12 V supply)
- An external IR sensor can be connected
- Delivery scope: Infra-red remote control, batteries, manual, safety notes, Scart cable, 230 V/12 V power supply unit

¹⁾ Only displayed if this information is broadcast by the channel provider

TECHNICAL APPENDIX

Type	CE	UFS 650si	UFS 650sw
Order no.		20210107	20210108
Colour		Silver	Black
RF characteristics			
Input frequency range	MHz	950-2,150	
Input level range	dB μ V	44-83	
TV system Video			
Modulation, FEC, de-multiplexer		DVB-S standard	
Video resolution		CCIR 601 (720 x 576 lines), 576p, 720p, 1080i	
Video decoding		MPEG-1 and MPEG-2 compatible	
S/N	dB	> 53	
TV system Audio			
Audio decoding		MPEG-1 and MPEG-2 compatible, layer 1 und 2	
Sampling rate	kHz	32/44.1/48	
S/N	dB	> 65	
Power supply			
Supply voltage (external power supply unit)	V _{AC} /Hz	230/50 \pm 10 %	
DC voltage	V	12	
Power consumption (operation/stand-by)	W	< 26/< 2.5	
LNB supply vert./horiz.	V/mA	14/18/max. 400	
Control signal	kHz	22; DiSEqC™1.0; SCR single-cable system	
Connections			
Sat-IF input/output (loop through)		2 x F-type socket	
TV/VCR output		2 x Scart socket	
Video output		Cinch socket	
Video/Audio output (digital)		1 x HDMI	
Audio output (analogue)		2 x Cinch socket	
Audio digital output (electrical)		Cinch socket	
Data interface		RJ 11 socket	
General			
Perm. ambient temperature	°C	+5 to +40	
Dimensions	mm	255 x 47 x 190	
Weight	kg	1.0	

TECHNICAL APPENDIX

SCART SOCKET ASSIGNMENT

Signal	Pin no.	TV	VCR/AUX
Right audio output	1	X	X
Right audio input	2		X
Left audio output	3	X	X
Audio earth	4	X	X
Blue earth	5	X	X
Audio left input	6		X
Blue signal	7	X	X
Switching voltage	8	X	X
Green earth	9	X	X
Data signal	10		
Green signal	11	X	X
Data signal	12		
Red earth	13	X	X
Data earth	14		
Red signal (C)	15	X	X
Blanking signal	16	X	X
Video earth	17	X	X
Blanking signal earth	18	X	X
Video output (FBAS/Y)	19	X	X
Video input	20		X
Connector shield	21	X	X

VHS/S-VHS SWITCHING

The Scart sockets are switchable between VHS and S-VHS. The switch is made by selecting "Main menu", "Settings", "TV, Video and Audio".

VHS (RGB): The red signal is connected to terminal 15, the composite colour output to terminal 19.
For S-VHS (Y/C): The Y output is connected to pin 19, the C output to pin 15.

TECHNICAL APPENDIX

CONNECTION EXAMPLE

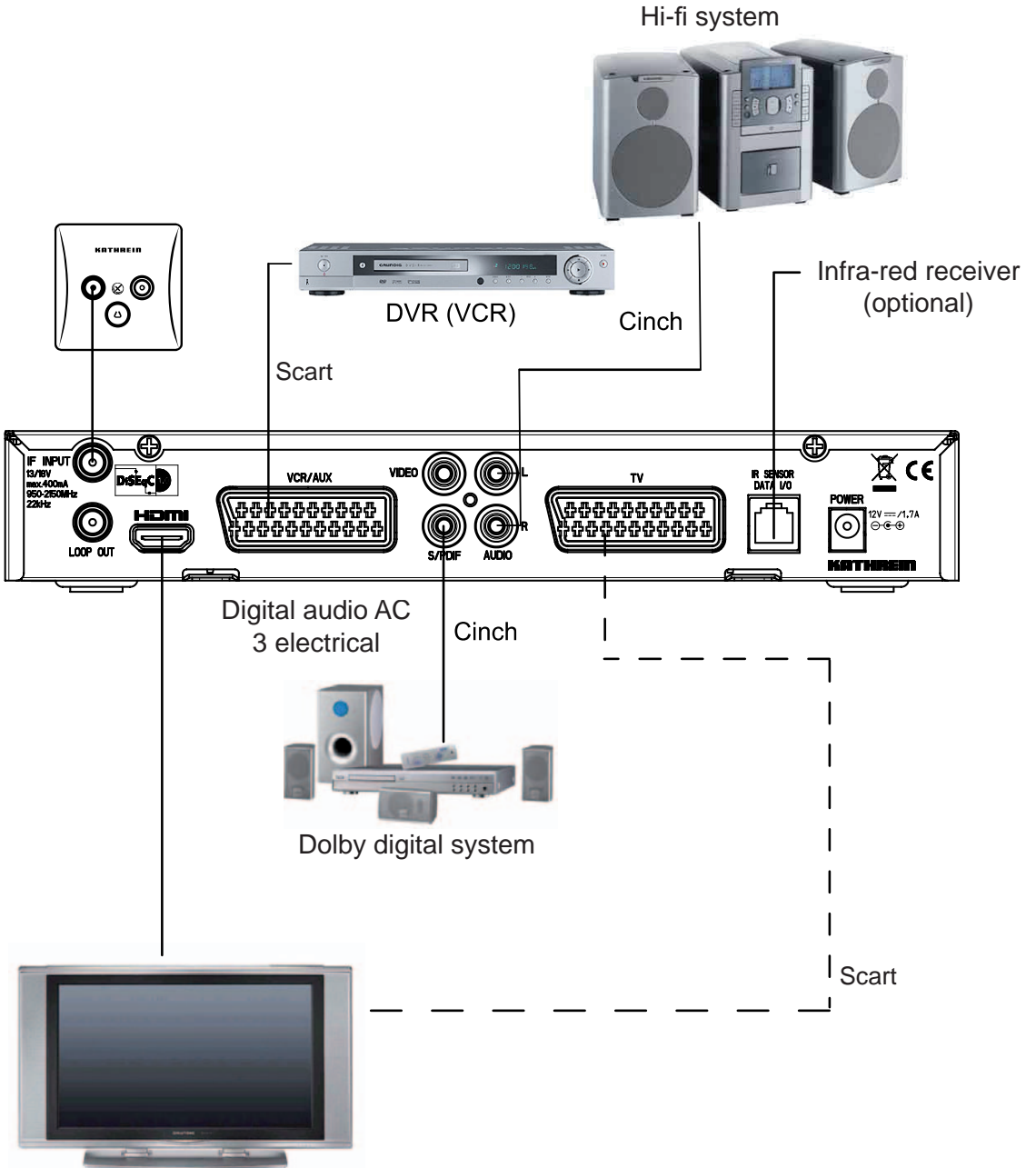

TECHNICAL APPENDIX

EXAMPLES OF single-cable systems

EXR 501/551/552

Single-cable switching matrices

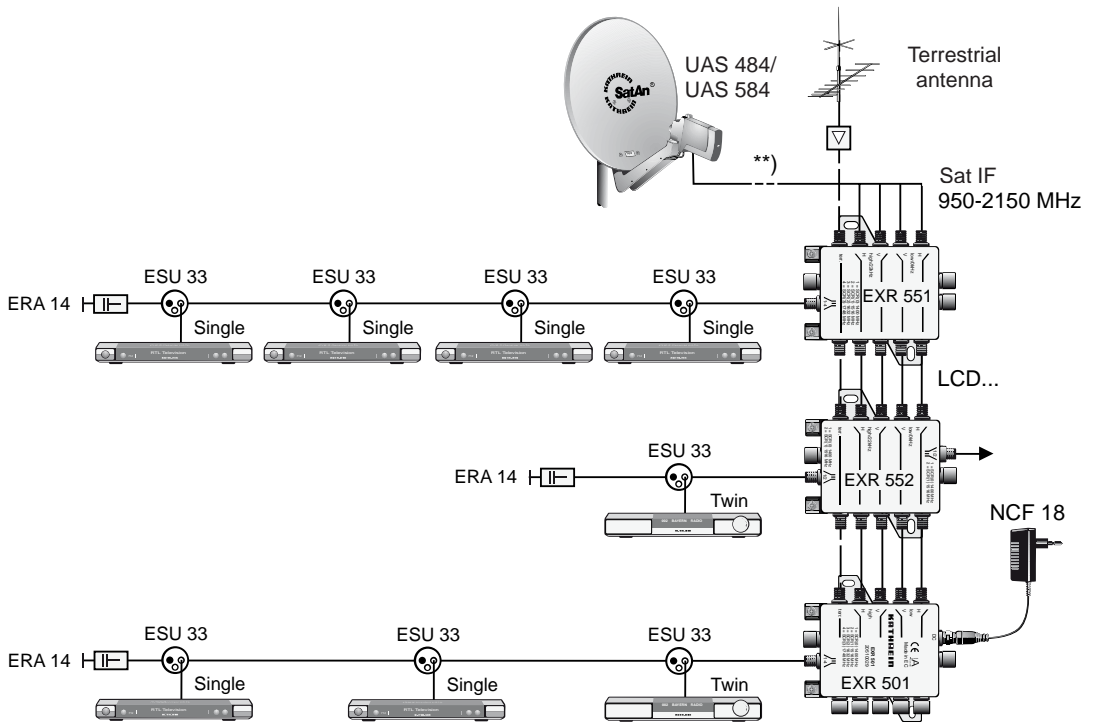

UAS 481

Single-cable feed system

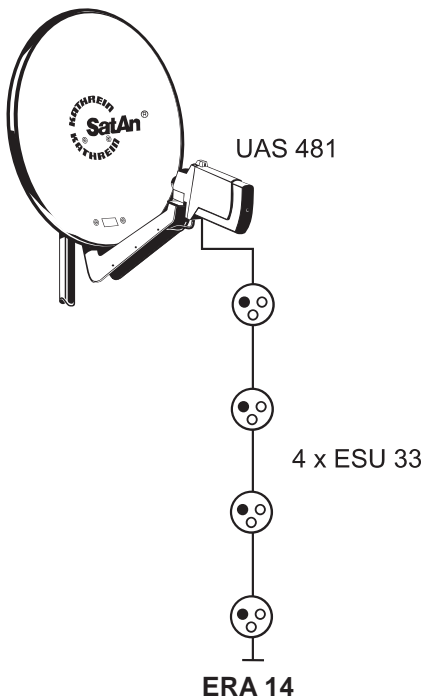
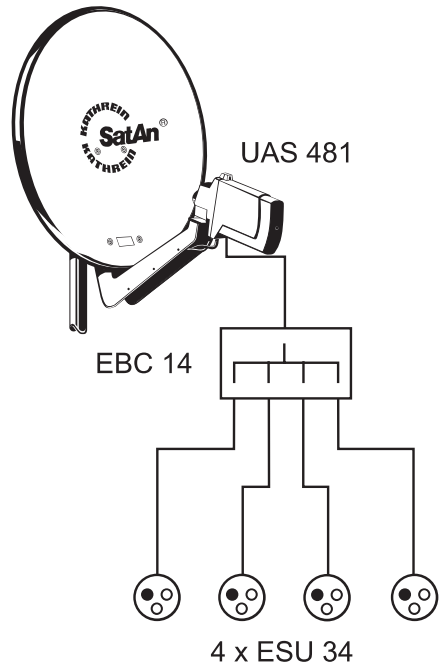
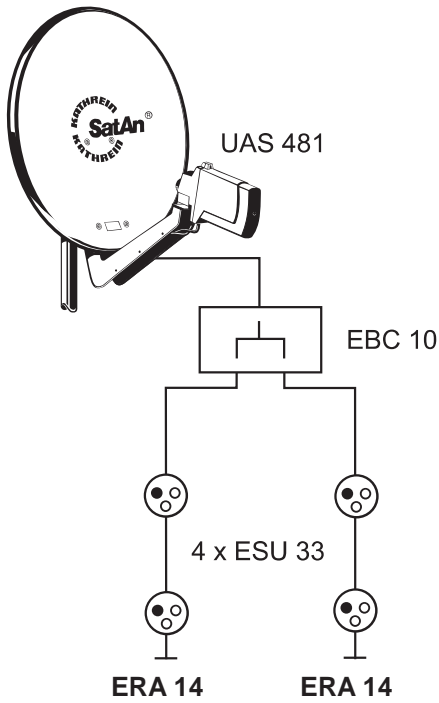

EXU 908

Single cable matrix

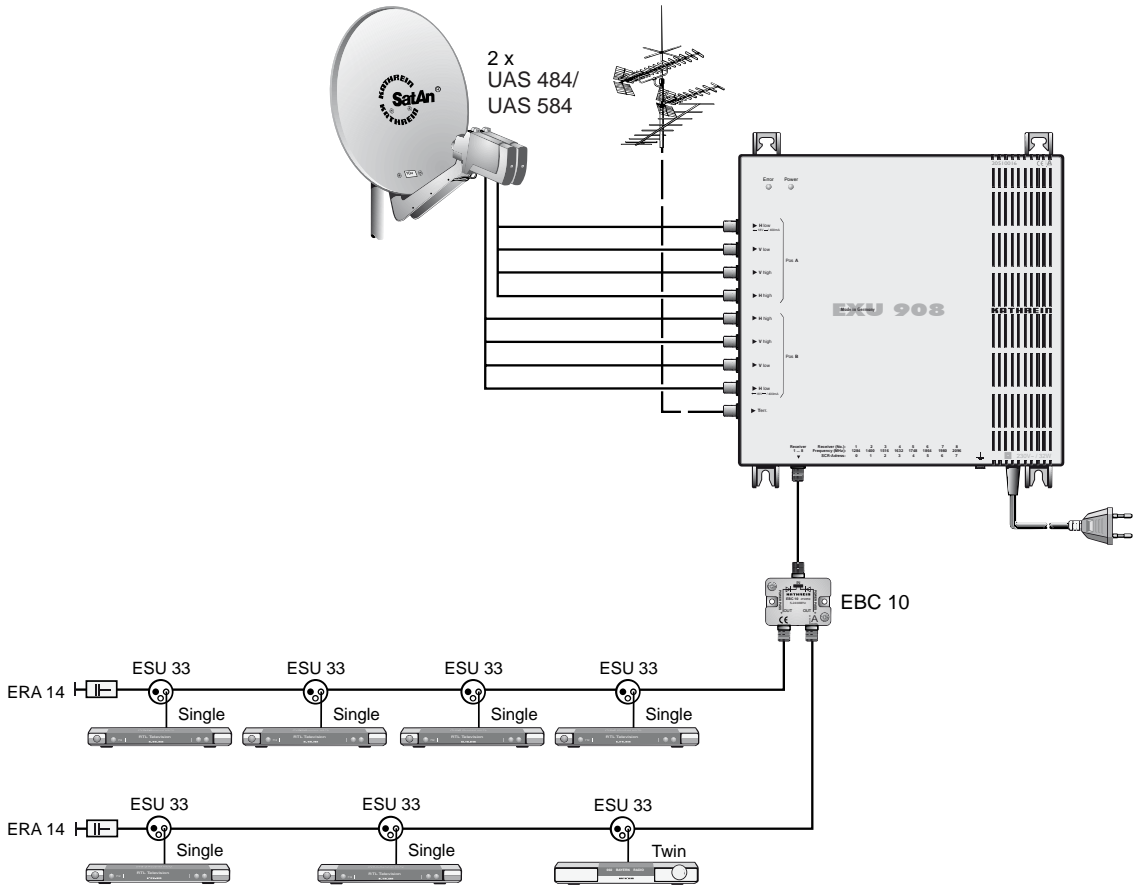

SHORT TECHNICAL GUIDE

CHANNEL PACKAGE

The channel package for a digital transponder normally includes several TV and radio channels. Each channel package has a fixed assignment for the transponder transmission frequency, for polarisation (horizontal or vertical), for the symbol rate and for the Viterbi rate or error rate.

DISEQC™

DiSEqC™ (Digital Satellite Equipment Control) is a communication system between a satellite receiver (master) and the peripheral satellite components (slaves), such as LNBS, multi-switches, rotating antenna systems.

It is a single master/multi-slave system, i.e. there is only ever one master in the satellite system. All activities start from the master.

DISEQC™ COMPONENTS

If DiSEqC™ switching matrices are cascaded, the master receiver must transmit the DiSEqC™ signal several times, so that all DiSEqC™ multi-switches in the cascade receive their commands.

These days, DiSEqC™ components (slaves) must be downward compatible, i.e. respond to the analogue switching criteria from receivers that are only equipped with H/V and 22 kHz control signals.

A DiSEqC™ switching matrix will work with analogue switching criteria until the DiSEqC™ command from the master is received. All analogue switching criteria are then ignored.

DVB MPEG-2

DVB is the abbreviation for Digital Video Broadcasting. DVB-S refers to the transmission method (S = satellite). MPEG is the abbreviation for Moving Picture Experts Group, a working group that formulates internationally applicable standards for the digital compression of video and audio. MPEG -2 has established itself as the standard for compression of digital TV signals. MPEG -2 works up to a data rate of 100 Mbit/s.

EB/NO RATIO

The Eb/No ratio is a measure of the signal to noise ratio of a digital signal. The value is not identical to the C/N value familiar from analogue reception technology. At Eb/No values below 5 dB no reception is normally possible.

FEC

FEC is the abbreviation for "Forward Error Correction". The FEC error rate corresponds to the Viterbi rate.

SHORT TECHNICAL GUIDE

PID

The PID (Packet IDentification) number is an identification number for video signals and audio signals in the digital data stream of DVB-MPEG -2 signals. The receiver uses the PID number to create a unique assignment for the video and audio data transmission. The PCR PID is the identification number for the synchronisation signal. The PID-PCR is normally identical to the video PID. For programmes broadcast in multiple languages, the audio PD can be entered manually to assign a different language to the TV programme. After the PID is entered, the digital receiver automatically selects the audio data identified by the PID number from the data stream and assigns it to the video signal.

SYMBOL RATE

The symbol rate describes the quantity of data that is transmitted per second. The symbol rate is measured in MSymbols/s and is equal to the number of symbols received per second.

TRANSPONDER

A transponder is a frequency converter which receives TV and radio signals broadcast from the earth, converts them and the rebroadcasts them to the earth at a different frequency. Each satellite carries several transponders.

Analogue transponders transmit only one TV channel and possibly multiple radio channels on a single transmission frequency.

Digital transponders simultaneously transmit several TV and several radio programmes on a transmission frequency. If a programme provider is broadcasting several TV channels via a digital transponder, we refer to the provider's channel package. The terms "digital transponder" and "channel package" have the same meaning.

VIDEO-BIT-RATE

The video bit rate describes the quantity of data from the digitised video signal that is transmitted per second.

VITERBI RATE

The Viterbi rate (code rate, error rate) characterises the error protection used by the programme provider. The DVB standard provides the following values: 1/2 - 2/3 - 3/4 - 5/6 - 7/8

SHORT TECHNICAL GUIDE

GLOSSARY



AC 3	Output for Dolby Digital signal
Audio output	Sound output on the receiver
AV programme pos.	Preferred programme position on TV set for Scart input
CA	Conditional Access (for decoding encrypted programmes)
CI	Internationally standardised interface for CA modules
Decoder	Decoder for Pay TV
DiSEqC™	Control system between receiver and LNB, multi-switch
DVB	Digital Video Broadcasting
Eb/No [dB]	Power density per unit of information
Eb/No ratio	Digital signal to noise ratio
LED display	Display on receiver
LNB	Low Noise Block Converter
Mute	Muting of sound
OSD	On Screen Display
PAL	Analogue TV standard
Pay TV	Pay-per-view TV channels (e.g. PREMIERE)
PCMCIA	Standard for internal decoder interface for pay-TV
PID	See "Short technical glossary"
PIN	Personal Identification Number
Receivers	Satellite receiver
RGB	Video signal made up of three individual colour signals (red, green, blue)
Satellite IF signal	Receiver input signal
Scart cable	21-pin connecting cable (e.g. receiver/TV)
Smart card	Card from Pay TV provider to decode its channels
Stand-by	Standby mode
S-VHS	Super Video Home System (video recorder standard)
Symbol Rate	Rate of data transmission of satellite signal
Timer function	Clock function for pre-programmed switch on and off times
Transponder	See "Short technical glossary"
VCR connection	Video recorder connection
Viterbi rate	See "Short technical glossary"

TROUBLESHOOTING

In the event of a malfunction, first check all the cable connections and operating states:

1. Receiver and TV set power plugs are connected to wall socket
2. Antenna cables on receiver input
3. Receiver and TV set correctly connected by a Scart or cinch cable
4. Audio connections are made to Hi-Fi or Dolby Digital system as appropriate
5. Receiver and TV set (Hi-Fi/Dolby Digital system) are switched on (check power indicators)
6. Receiver is responding to remote control

A selection of troubleshooting tips is offered below.

Problem	Cause	Remedy
"Weak or no signal!" warning appears on some or all channels	Antenna signal of satellite reception system missing or faulty. Incorrect LNB frequencies set in the "Antenna Configuration" menu.	Consult an antenna specialist to have it checked and repaired as necessary. On "Installation" menu check LNB configuration for the satellite in question: High L.O. "10.600" GHz, Low L.O. "9.750" GHz, and Limit frequency L.O. "11.700 MHz", and change as necessary.
Remote control no longer responding	Receiver or remote control command set may have been unintentionally changed	Set infrared code 1 (simultaneously press the buttons  + ). Check the batteries
Wrong time being displayed	"Summer Time" setting wrong. An incorrect time was imported from the reception signal	On "Settings" - "Date and Time Setup" menu check "Summer Time Enabled" and change as necessary Switch off receiver at mains switch from current channel, e.g. ARD or ZDF, wait 10 seconds and then switch back on
The following channels cut out or "Weak or no signal!" appears: DSF, Tele 5, HSE 24 and Sonnenklar TV	DECT telephones operate on the same frequency as these channels. Interference may occur due to inadequate level or poor shielding of cable	Consult your antenna specialist
Black or blue screen, no on-screen displays	Scart connection to TV deactivated by accidentally pressing the 0 button	Keep pressing the 0 button until the TV picture reappears on-screen

936.3434/B/1108/ZWT - Technical data subject to change.

Free Manuals Download Website

<http://myh66.com>

<http://usermanuals.us>

<http://www.somanuals.com>

<http://www.4manuals.cc>

<http://www.manual-lib.com>

<http://www.404manual.com>

<http://www.luxmanual.com>

<http://aubethermostatmanual.com>

Golf course search by state

<http://golfingnear.com>

Email search by domain

<http://emailbydomain.com>

Auto manuals search

<http://auto.somanuals.com>

TV manuals search

<http://tv.somanuals.com>