

DVB-SAT Receiver UFS 733si/sw



KATHREIN
Antennen · Electronic

FOREWORD/IMPORTANT INFORMATION

Dear customer,

This operating manual is intended to help you make the fullest use of the extensive range of functions offered by your new satellite receiver.

We have tried to make the operating instructions as easy as possible to understand, and to keep them as concise as possible.

If you will not be using your receiver for a longer period, you should disconnect it from the mains to save energy. For shorter breaks, you can use the remote control to switch the receiver to standby, which uses only a minimal amount of energy.

We wish you good reception and much pleasure using your new DVB-Sat receiver.

Your

KATHREIN team

IMPORTANT INFORMATION

The channels available on the satellite transponders are subject to continual change. This means the channel settings have to be regularly updated, even though the factory presetting always represents the latest version when the receiver was shipped. The information for these settings can be found on the Internet or in relevant magazines.

Your receiver was equipped in the factory with the latest software version at that time. We are, however, constantly working on adapting the software to the wishes of our customers and to developments in technology. The "Software Update" section provides more information on this aspect.

The information in this operating manual was correct at the time of going to press. We reserve the right however to make changes at any time and without prior notice. If new software is released for your receiver, and this affects the information in the operating manual (e.g. changes to the menus and/or functions), if we believe it necessary we will make available a new operating manual for download under "www.kathrein.de".

**Please keep the original packaging in case you need to return the product at any time!
If the product is not properly packed, the warranty claim is invalidated.**

Make a note of the receiver's basic settings (these are set during the first installation), so you can restore them if necessary!

The term DiSEqC™ used in this operating manual is a registered trade mark of the European Telecommunication Satellite Organisation (EUTELSAT).



In order to disconnect the UFS 733 from the mains completely, the mains plug must be unplugged from the wall socket! Therefore place the UFS 733 near to a wall socket and make sure the socket is accessible, so that at any time (e.g. during a thunderstorm or during a long absence) you can disconnect the receiver from the mains.

IMPORTANT INFORMATION

INFORMATION ON AUDIO MPEG INC. AND S.I.SV.EL, S.P.A:

This unit makes use of legally protected technologies, which are protected by patents in the USA and also by other intellectual property rights in other countries.

KATHREIN-Werke KG has obtained licences from Audio MPEG Inc. and Societa' Italiana per lo sviluppo dell'elettronica, S.I.SV.EL, S.P.A to use these technologies. These licences carry certain restrictions, which apply also to you as the customer.

Accordingly this unit may be used by the end customer only for private non-commercial purposes and for the licensed content. It may not be used for commercial purposes. The use of products or processes that are sold or used with this unit is not included in this statement.

The use of reverse engineering is not permitted in respect of the licensed technologies, nor is disassembly.

DISPOSAL INSTRUCTIONS



Electronic equipment is not domestic waste - in accordance with directive 2002/96/EC OF THE EUROPEAN PARLIAMENT AND THE COUNCIL dated 27th January 2003 concerning used electrical and electronic appliances, it must be disposed of properly.

At the end of its service life, take this unit for disposal at a designated public collection point.



Spent batteries are special waste!

Do not throw spent batteries into your domestic waste; take them to a collection point for spent batteries.

SERVICE

If, despite reading through this operating manual, you still have questions about getting started with the unit or using it correctly, or if unexpected problems occur, please contact your specialist dealer.

CONTENTS

| | |
|---|-----------|
| Foreword/important information | 2 |
| Important Information | 3 |
| Contents | 4 |
| Receiver features and product package | 6 |
| Safety instructions | 7 |
| Connection and setup | 8 |
| Controls, displays and connections | 9 |
| Remote control | 10 |
| First installation | 11 |
| Operation | 26 |
| Using the remote control | 26 |
| Channel selection (TV and radio) | 26 |
| Channel selection from the channel list | 27 |
| Banner | 28 |
| Audio/subtitle selection | 28 |
| Opening options channel..... | 29 |
| Picture scaling and audio output format | 29 |
| Teletext | 29 |
| EPG (Electronic Program Guide) | 30 |
| Opening the EPG | 30 |
| “Current” view | 31 |
| “Preview” view (programme magazine) | 32 |
| Categories view | 33 |
| Search function | 34 |
| Additional information (i button)..... | 35 |
| Recording (timer) | 36 |
| Recording once only | 37 |
| Recording daily..... | 37 |
| Recording weekly..... | 38 |
| Recording Monday to Friday | 39 |
| Timer list view | 40 |
| Common Interface | 41 |
| Important Information | 41 |
| Inserting the Smartcard and the CA Module | 41 |
| Inserting the CA module into the CI..... | 41 |
| Inserting the Smartcard into the Smartcard reader | 41 |
| Main menu | 42 |
| Editing channel list | 43 |
| Sorting channels in channel list (left column) | 43 |
| Deleting channels from channel list | 43 |
| Favourite lists..... | 43 |
| Adding a channel to favourite list..... | 44 |

CONTENTS

| | |
|---|-----------|
| Deleting a channel from favourite list..... | 45 |
| Sorting channels in favourite list..... | 45 |
| Search for channels..... | 46 |
| Automatic SEARCH..... | 47 |
| Manual Search..... | 49 |
| Security..... | 50 |
| Box Settings..... | 51 |
| Video Settings..... | 52 |
| Menu Settings..... | 53 |
| Miscellaneous Settings | 54 |
| Conditional Access (Common Interface) | 55 |
| CONAX CA - Smartcard reader..... | 55 |
| Cryptoworks - CI (CA module) | 57 |
| LNB settings | 58 |
| Service menu | 59 |
| Sat Finder..... | 60 |
| Channel information..... | 60 |
| System Information..... | 61 |
| Updating software | 61 |
| Restoring factory settings..... | 65 |
| Language | 66 |
| Technical appendix..... | 67 |
| Technical features | 67 |
| Scart socket assignment | 69 |
| VHS/S-VHS switching..... | 69 |
| Connection example..... | 70 |
| Examples single-cable systems | 71 |
| For your notes..... | 75 |

RECEIVER FEATURES AND PRODUCT PACKAGE

RECEIVER FEATURES

The UFS 733 receiver is suitable for the reception of digital satellite TV and radio channels. The decoding system for Conax is already integrated. In addition one Common Interface for a CA module is provided for decoding additional Pay-TV channels.

The HDMI interface offers the optimum capability for connecting the receiver to a flat-screen TV set.

The receiver has comprehensive features such as 16-character alphanumeric display for program names, electrical and optical audio outputs for Dolby Digital (AC3) and Videotext with memory capacity for 800 pages.

The receiver is available in silver or black housings.

SWITCHING OFF THE RECEIVER AND UPDATING THE EPG

By pressing the  button on the remote control you can switch the receiver out of TV mode to the standby mode, and back again.

The receiver has the facility to update the EPG overnight, i.e. at 03:00 the receiver automatically starts to update the EPG data. This procedure may take a few minutes, and is not shown in the receiver display. If the receiver is programmed to make a recording at this time, the updating is postponed until 03:00 the following night.

The update time cannot be changed.

This updates the EPG data for the first 25 channels of the overall channel list. However, this update is only performed if the receiver is in the standby mode. If the receiver is completely switched off (at the mains) or if it is in operation, the update will be delayed. After updating the data, the receiver automatically switches

back to the standby mode. If during the update you press the  button, the update is aborted and the receiver switches itself on.

PRODUCT PACKAGE

- UFS 733si (silver) or UFS 733sw (black)
- Infra-red remote control
- Scart cable
- 2 batteries AAA 1.5 V
- Power supply cable
- Operating manual
- Safety instructions

SAFETY INSTRUCTIONS

GB

Safety Instructions – Important Information

This page contains important information about the operation, installation location and connection of the unit. Read these instructions carefully before starting to use the unit.



DANGER!

Mains cable

Make sure that the mains cable (power supply cable) is not damaged. Units with a damaged mains cable must be disconnected from the mains (disconnect mains connector) and repaired by a qualified engineer before setup. Only use the power pack supplied (if available)!

Risk of death due to electric shock!

Cleaning

Disconnect the mains connector before cleaning the unit. Only use a dry cloth for cleaning and only clean the outer surface. Never open the unit.

Touching the parts inside the unit carries a risk of death due to electric shock!

Playing children

Make sure that children do not push any objects into the ventilation slots.

Risk of death due to electric shock!



WARNING!

Earth connection

The antenna system must be earthed as specified or equipotentially bonded. EN 60728/11 and any national regulations must be complied with.

Danger due to surge voltages, lightning strikes!

Mains voltage

Only operate the unit with the specified mains voltage (marked on the rear of the unit or on the external power pack)! The unit may only be connected to the mains and turned on once it has been connected to the antenna and to the TV set or the cable network and PC.

If the mains voltage is too high, there is a risk of fire!

Repairs

Ensure that any repairs to your unit are carried out by qualified personnel. Opening the unit and attempting to repair it yourself voids all warranty claims!

Improper work on the unit can jeopardise the electrical safety of the unit.

The manufacturer accepts no liability for accidents caused by the user opening the unit!



CAUTION!

Connections

Incorrect wiring of the connections can lead to malfunctions or defects on the unit!

Long periods of absence/storms/accessibility of the mains connector

Always turn off the unit at the mains switch if you will be absent for a long time or there is a storm. Disconnect it from the mains by unplugging the mains connector. This also applies to the other equipment connected to the unit. Isolation from the cable network is also recommended. Note any timer programs (receiver) and turn the unit on again promptly before the recording time. Ensure the mains connector is accessible at all times.



Installation location

All electronic equipment generates heat. However, the heating of this unit lies within the permissible range. Sensitive furniture surfaces and veneers may become discoloured by the effects of constant heat over time. The feet of the unit can also cause colour changes to treated furniture surfaces. If necessary, place the unit on a suitable stable and flat base!



Ventilation

The heat generated in this unit is adequately dissipated. However, the unit should never be installed in a cupboard or on shelves with inadequate ventilation. Never cover the cooling slots on the unit (e.g. with other equipment, magazines, tablecloths or curtains)!

Do not place any objects on top of the unit and maintain a clearance of at least 10 cm above the unit, so that the heat generated can be dissipated with no obstructions.

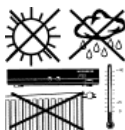

Moisture, sunlight, heat, naked flames

Protect the unit against moisture, dripping and splashed water (do not place any filled objects such as vases on top of the unit). Do not place the unit close to a heater or expose it to direct sunlight and do not operate it in damp locations. Only use the unit in a moderate climate, not in tropical conditions! Do not expose the unit to any naked flame, such as from a candle! This constitutes a fire hazard!

CONNECTION AND SETUP

The following section is intended specifically for specialist dealers. You need not refer to this section unless you are carrying out the installation yourself. The “Connection Example” section provides a sample configuration.

Do not connect the receiver to the mains until all installation work has been properly carried out. Refer also to the information in the “Safety Instructions” section.

CONNECTING THE RECEIVER

SAT IF CONNECTION

Connect the Sat IF input on the receiver to the satellite reception system.

Use a coaxial cable with a standard F connector.

If the F connector is not yet fitted to the cable, strip the insulation from the cable as shown in the following illustration and carefully twist the F connector onto the end of the cable until it is securely fitted to the cable.

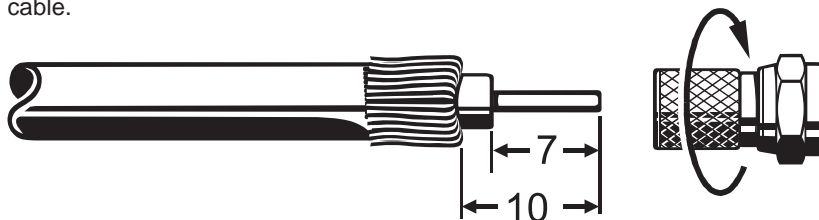

When fitting the connector, make sure that no strands from the braiding touch the inner conductor, otherwise a short circuit may occur.

The quality of the reception signal depends on this connection!

RECEPTION REQUIREMENTS

Ensure that your satellite antenna system is designed for digital reception.

RECEPTION SYSTEM PRESETS

The presets for the control signals have been made for standard reception systems, i.e. 14/18 V for polarity reversal and 22 kHz switching signal for low/high band changeover. Be sure to follow the operating instructions for the matrices used.

The parameters defined in the “Main menu”, “Channel search” and “LNB settings” should only be changed by experienced installers.

TV CONNECTION

Connect the satellite receiver (TV Scart socket) to the TV set with a Scart cable. If your TV is stereo, you can receive the sound in stereo via the Scart connection. Connect the satellite receiver to the video/DVD recorder with a Scart cable.

INSERTING BATTERIES IN THE REMOTE CONTROL

Remove the cover on the rear of the remote control.

Insert the two batteries supplied into the remote control. Ensure correct polarity of the batteries; the + and – markings are indicated inside the battery compartment. Slide the cover back into the housing until it locks in place.

CONTROLS, DISPLAYS AND CONNECTIONS

This section provides a brief description of all the controls, displays and connections.

VIEW OF FRONT PANEL (FLAP FOLDED DOWN)

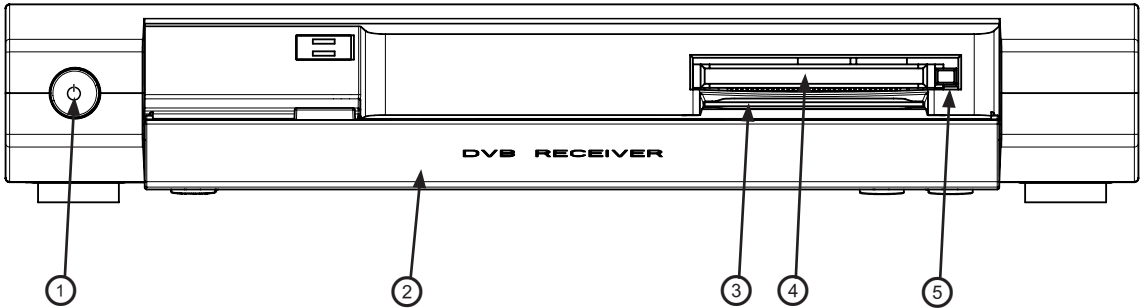

VIEW OF REAR PANEL

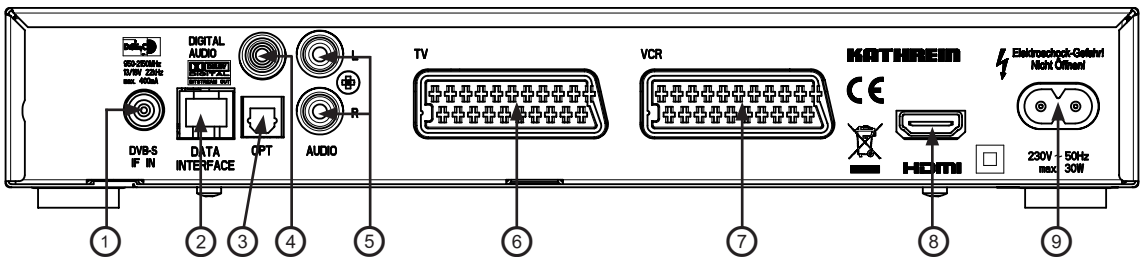

Front panel controls and displays

1. On/Off switch
2. Display (cover folded down)
3. Smartcard reader*) (Conax embedded)
4. Common Interface for fitting a CA module *)
5. Ejection button for the CA module

In addition there are three further buttons on the front of the display:

- TV/R button for switching between TV and radio mode
- Channel select buttons (▼▲)

Rear panel controls and displays





















1. LNB input
2. RJ 11 data interface
3. Optical data stream output (SPDIF/Sony Philips Digital Interface Format) for Dolby Digital AC 3 audio
4. Electrical data stream output (SPDIF/Sony Philips Digital Interface Format) for Dolby Digital AC 3 audio
5. Audio outputs (L/R) - cinch sockets
6. Scart socket for TV connection
7. Scart socket for VCR/AUX connection
8. HDMI connection
9. Mains power cable

*) CA module and Pay-TV cards (Smartcards) are not included

REMOTE CONTROL

REMOTE CONTROL FUNCTION BUTTONS

The button symbols shown here are also used in the description of the operating steps.

| | | |
|--|--|--|
|  Mute on/off |  |  Off mode (Stand-by) |
|  To enter channel numbers or menu parameters | |  (Green) Open video and audio settings, select mono (left, right) and stereo |
|  Open main menu | |  Open Videotext |
|  (Red) Open favourite list, open timer list in the EPG | |  (Yellow) Open options menu |
|  Volume | |  (Blue) Switch between radio and TV mode |
|  (cursor buttons) Switch the channel and/or navigate the menus | |  Channel selection |
|  (EXIT) close menus and sub-menus | |  Channel information on the current channel |
|  Currently not used | |  Confirm sub-menus and menu options, open channel list |
|  Currently not used | |  Open electronic program guide |
|  Currently not used | |  Currently not used |
|  Open timer menu in the EPG | |  Currently not used |

FIRST INSTALLATION



Before using your unit for the first time, read the “Safety Instructions” and “Connection and Setup” sections.



The “Connection Example” section provides a sample configuration.

Do not connect the receiver to the power supply until all installation work has been properly carried out.

The guidance given in the “First Installation” section assumes that the receiver has been properly connected as per the “Safety Instructions” and “Connection and Set-Up” sections.

First switch your TV set on and select the AV channel slot. Connect your receiver to the power supply. The following display appears:



Use the   buttons to select the desired menu language. Pressing the  (green) button loads the desired menu language and opens the next menu:

FIRST INSTALLATION



Press the buttons to select the desired country. Press the buttons to switch to the “HD Video Resolution” line. Set the video resolution of your TV set here using the buttons (only on connection of the receiver and the TV set using the HDMI interface). Refer to the user guide/operating instructions for your TV set.

Press the buttons to switch to the “Screen Format” line. Use the buttons to set the screen format for your TV set. Refer to the user guide / operating instructions for your TV set.



Press the buttons to switch to the “Picture Scaling” line. Use the buttons to perform the settings for the picture scaling. Refer to the user guide / operating instructions for your TV set.

Press the buttons to switch to the “TV Output Format” line. Select here the signal that your TV set can process using the buttons (only on connection of the receiver and TV set using the Scart TV socket). Refer to the user guide/operating instructions for your TV set.

Press the (green) button to open the next menu:

FIRST INSTALLATION



Select the required setting for your LNB control using the   buttons (only on connection of the receiver to a satellite reception system). The following options are available:

- DiSEqC™1.0
- One cable (automatic or manual setting)
- No LNB power (if your LNB has a dedicated power supply)
- No DiSEqC™
- Toneburst

Continue the first installation with the related section.

FIRST INSTALLATION (DISEQC™1.0)

DISEQC 1.0



If you do not know the settings or components used in your reception system, ask a specialist engineer!



Press the buttons to switch to “DiSEqC sequence”. Select how often the DiSEqC™ command is to be sent using the buttons.

Changes to the positions A - D:



Press the buttons to switch to “Position A”. Press the button to open the sub-menu. You can select a satellite and make the related settings here. Press the (green) button. If you change the default setting (in this example “ASTRA 19.2°E”), a prompt “Save LNB settings?” will be displayed. Select “Yes” or “No” using the buttons and accept your selection using the .

Repeat the process as necessary for the other positions (B, C, D).

Press the (green) button to open the next menu:

Continue the first installation with the “Search” section.

FIRST INSTALLATION: Single-cable system (general)

Use the   buttons here to select "One Cable" as "LNB control". Press the  button to move to the next menu item:



The various options for a single-cable system with Kathrein components are summarised at the end of this manual in the "Technical Appendix" section under "Examples of Single-Cable Systems". Depending on the system to which they are connected, a maximum of four or eight receivers may be connected to a single-cable system (a twin receiver counts as two receivers).

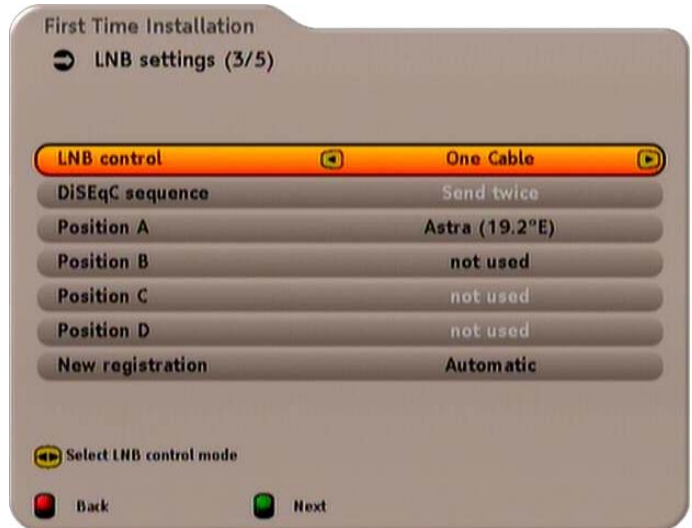

Satellite selection

Press the  button. The following display appears:





If the receiver is connected to a UAS 481 single-cable LNB, it is imperative the two frequencies (low band/high band) are set to 10200 MHz here.

You can make the settings using either the number pad or the

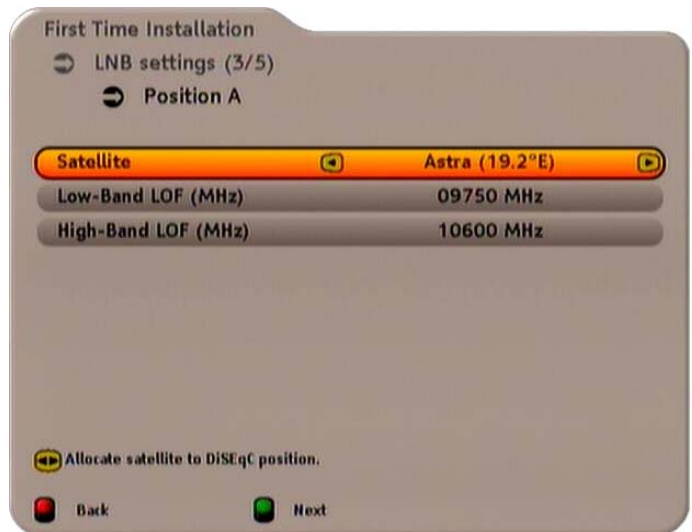

  buttons.



Use the   buttons here to select the satellites you want to receive with your system. Press the  (green) button to open the next menu:

Note: *You can only receive the signals from two satellites in your single-cable system if a EXU 908 single cable matrix is used. In this case, repeat the "Satellite selection" process for the "Position B" line.*

FIRST INSTALLATION: Single-cable system (general)

Select the “New registration” line using the   buttons. Using the   buttons, select whether the registration on the single-cable system is to be “Automatic” (receiver) or “Manual” (user). Press the  (green) button to open the next menu:



It is currently only possible to register on the EXU 908 single-cable matrix using the “Manual” mode.

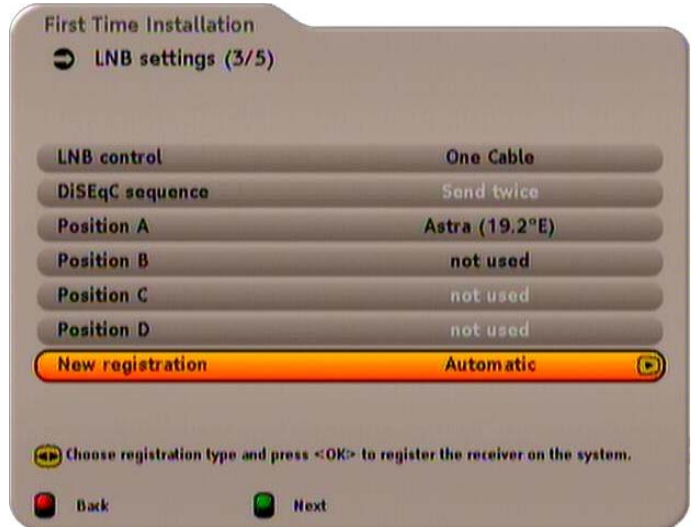

For improved understanding, we have split the following explanation into two sections. Registration with the selection “Automatic” and registration with the selection “Manual”.

FIRST INSTALLATION: Single-cable system (automatic)

AUTOMATIC



You can only use the "Secure channel with PIN" function if this function is supported by the single-cable components used. In the case of Kathrein EXU 908, single-cable components, this is currently only the case for the EXU 908.

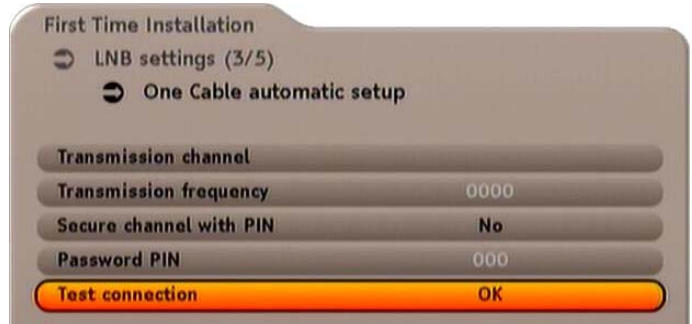

Secure channel with PIN (only for on selection of "User defined" or "Kathrein EXU 908"):

Press the button to switch to the "Secure channel with PIN" line. Here it is possible to protect the transmission frequency used by entering a PIN. No other receiver can then use that transmission frequency unless the PIN is input. Select the setting "Yes" using the buttons.

Password PIN (only for "Yes" setting in the "Secure channel with PIN" line):

Select the "Password PIN" line using the button. You can now use the number buttons to enter a PIN (0-255).

Testing connection:

Use the button to switch to the "Test connection" line and press the button. The receiver now tests the settings you have made. The following message appears:

Select a spare transmission frequency using the buttons and then confirm your selection using the button. The following screen appears:



FIRST INSTALLATION: Single-cable system (manual)

Press the **OK** button to confirm.

Press (if necessary several times) the **PP** (green) button until you reach the "Channel list selection" point.

Continue the first installation with the "Search" section.

Press the **OK** button to confirm and check your settings. If necessary, seek assistance from a specialist engineer.

Use the **▼** button to switch to the "Test connection" line again and press the **OK** button. As soon as the receiver outputs the "Connection OK" message, you can continue as described on the left.

MANUAL

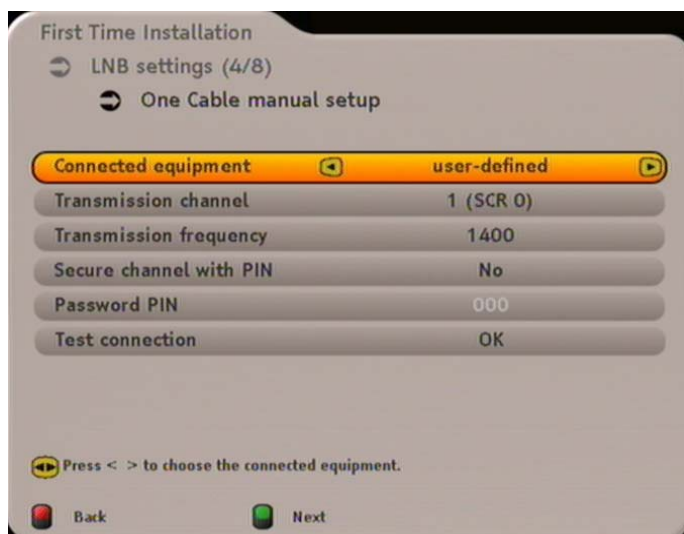

Connected equipment:

Select the single-cable components used in your system using the **◀ ▶** buttons.

Available options: Kathrein 2 subscribers (EXR 552), Kathrein 4 subscribers (EXR 501, EXR 551), Kathrein 8 subscribers (EXR 1581, EXR 2581, EXU 908) or User defined (UAS 481).

We have selected the UAS 481 single-cable LNB as an example for the remainder of this explanation. If there are differences to other components or to the setting "User defined", we will note and explain these differences.

Transmission channel:

Press the **▼** button to switch to the "Transmission channel" line. Select the required transmission channel using the **◀ ▶** buttons.



If one or more receivers are already present on the system and an additional receiver is to be connected, you must assign a different frequency (transmission channel) to the new receiver (otherwise the receivers will interfere with each other).

FIRST INSTALLATION: Single-cable system (manual)



Transmission frequency (only with the selection “User defined”):

Use the  button to switch to the “Transmission frequency” line and enter the appropriate transmission frequency using the number pad. You can find the necessary information (transmission frequencies) in the documentation supplied with your system.



You can only use the “Secure channel with PIN” function if this function is supported by the single-cable components used. In the case of Kathrein single-cable components, this is currently only the case for the EXU 908.



Secure channel with PIN:

Press the  button to switch to the “Secure channel with PIN” line. Here it is possible to protect the transmission frequency used by entering a PIN. No other receiver can then use that transmission frequency unless the PIN is input. Select the setting “Yes” using the   buttons.

Password PIN (only for “Yes” setting in the “Secure channel with PIN” line):

Select the “Password PIN” line using the  button. You can now use the number buttons to enter a PIN (0-255).

Testing connection:

Use the  button to switch to the “Test connection” line and press the  button. The receiver now tests the settings you have made. The following message appears:





Press the  button to confirm.

Press (if necessary several times) the  (green) button until you reach the “Channel list selection” point.

Continue the first installation with the “Search” section.

Press the  button to confirm and check your settings. If necessary, seek assistance from a specialist engineer.

Use the  button to switch to the “Test connection” line again and press the  button. As soon as the receiver outputs the “Connection OK” message, you can continue as described on the left.

FIRST INSTALLATION (NO LNB POWER)

NO LNB POWER



If you do not know the settings or components used in your reception system, ask a specialist engineer!



Press the buttons to switch to the "Position A". Press the button to open the sub-menu. You can select a satellite and make the related settings here. Press the (green) button. If you change the default setting (in this example "ASTRA 19.2°E"), a prompt "Save LNB settings?" will be displayed. Select "Yes" or "No" using the buttons and accept your selection using the button.

Press the (green) button to open the next menu:

Continue the first installation with the "Search" section.

FIRST INSTALLATION (NO DISEQC)

NO DISEQC



If you do not know the settings or components used in your reception system, ask a specialist engineer!



Press the buttons to switch to the "Position A". Press the button to open the sub-menu. You can select a satellite and make the related settings here. Press the (green) button. If you change the default setting (in this example "ASTRA 19.2°E"), a prompt "Save LNB settings?" will be displayed. Select "Yes" or "No" using the buttons and accept your selection using the button.

Press the (green) button to open the next menu:

Continue the first installation with the "Search" section.

FIRST INSTALLATION (TONEBURST)

TONEBURST



If you do not know the settings or components used in your reception system, ask a specialist engineer!



Press the buttons to switch to the "Position A". Press the button to open the sub-menu. You can select a satellite and make the related settings here. Press the (green) button. If you change the default setting (in this example "ASTRA 19.2°E"), a prompt "Save LNB settings?" will be displayed. Select "Yes" or "No" using the buttons and accept your selection using the button. Repeat the process as necessary for the second position (B).

Press the (green) button to open the next menu:

Continue the first installation with the "Search" section.

FIRST INSTALLATION (SEARCH)

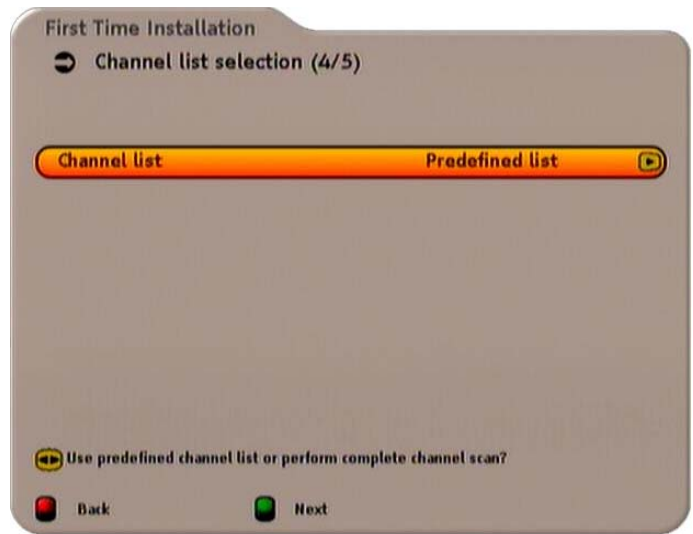

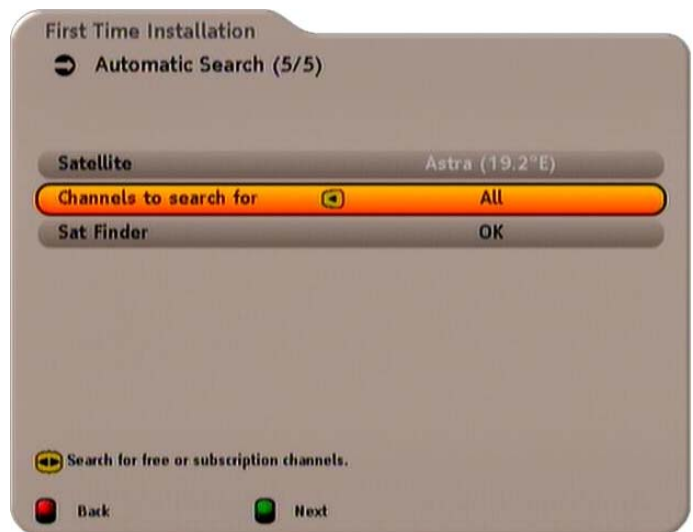

Using the buttons, select whether you want to use the pre-defined satellite channel list or start a search. Confirm your selection using the (green) button. If you select "Predefined list", that completes the first installation. If you select "Search Channels", the following display appears:





Use the buttons to select whether you want the search to cover all satellites or only one specific satellite. Using the buttons switch to the "Channels to search for" line. Here, using the buttons, you can select whether you want to search only for free-to-air channels, only for encrypted channels, or for all channels. The receiver also provides you with a feature for checking the reception system settings in the "Sat Finder" line. Open using the button. The following display appears:

FIRST INSTALLATION (SEARCH)

If you do not have a meter for adjusting your reflector, you can use the sat finder as an alignment aid. You can select the different

lines using the   buttons. Make changes in the lines using the

  buttons (e. g. transponder). Once you have a good reception signal (see example on the right),

press the  button in the "Finish" line.

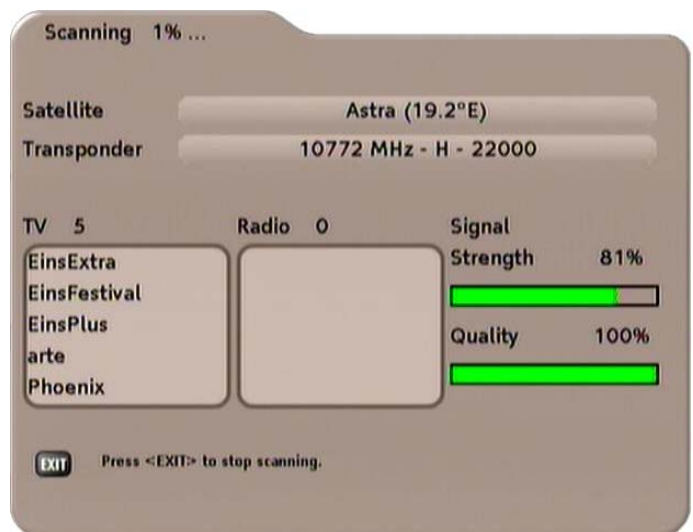
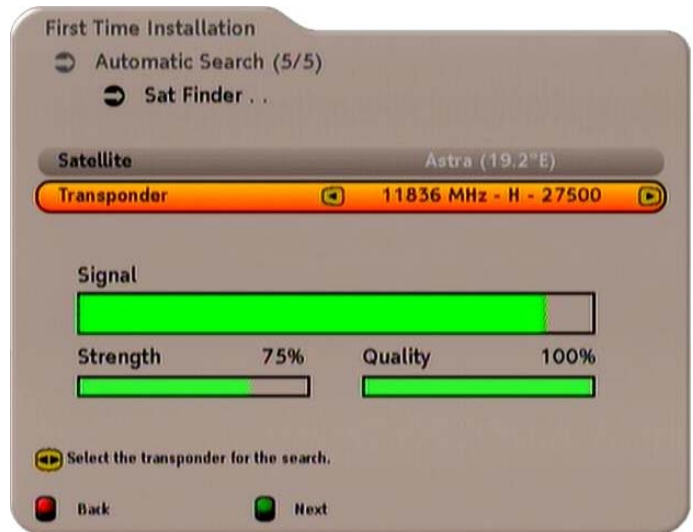

Press the  (green) button to open the next menu:

FIRST INSTALLATION (SEARCH)

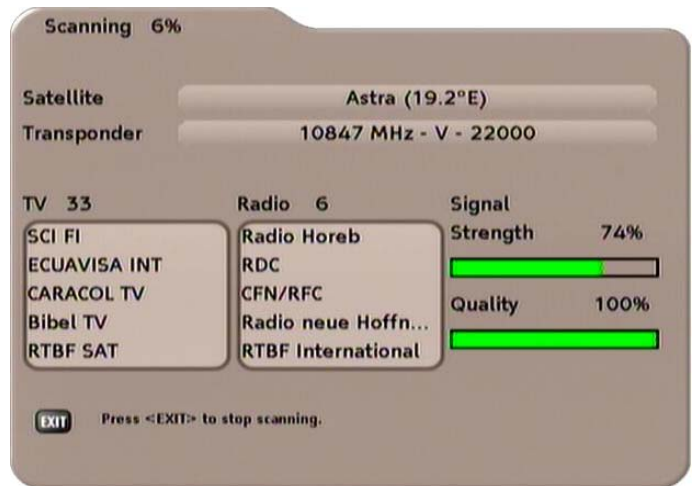

After completion of the search, you will see the following window:





Press the **OK** button to confirm the message displayed. The channels found are saved and the next menu opens:







Press the **OK** button to acknowledge the display and finish the first installation.

OPERATION

USING THE REMOTE CONTROL

Press the  button to confirm settings in the menus or to open sub-menus. Change the settings line by line and press the  button to save your changes. Press the  button to quit the menu or to switch from a sub-menu to the next higher menu level.

Use the   buttons to navigate through the menus. Use the   buttons to edit the individual fields. You can also key in values in the fields using the number pad.

The coloured buttons are used for the functions within the various sub-menus. These functions are displayed on-screen for the respective menus. In each menu a line is displayed at the bottom of the screen explaining the various functions available.

CHANNEL SELECTION (TV AND RADIO)

Press the  button (blue) to switch between TV and radio channels. Channel selection is same in both modes.

You can select the channels directly in the order in which they are saved using the  buttons. You can only select the channels in the currently selected channel list or favourite channel list.

OPERATION

CHANNEL SELECTION FROM THE CHANNEL LIST

Open the currently selected channel list/favourite list by pressing the **OK** button. The following display appears (example):

Channel list currently selected. Using the **◀▶** buttons you can select between the existing, pre-sorted channel lists.

A channel newly found by a search is marked with an "N" after the channel name (see example below).

903 SAT.1 **N**

Also note the bars at the bottom of the on-screen display! These provide information on what to do next.



In the channel list the channels are selected from a list using the **▲▼◀▶** buttons and a channel is opened using the **OK** button. The following functions are available for moving in the channel list or displaying and sorting the list:

FAV (red) button: Open the favourite lists (only displayed if contain programs). The favourite lists can also be opened directly from the TV screen using the **FAV** (red) button.

EXIT button: Leave the channel list without changing to another channel

◀▶ buttons: Change between the (pre-sorted) channel lists available

OK button: Press 1 x to change to the selected channel, press 2 x to change to the selected channel and leave the channel list

OPT (yellow) button: Using the **◀▶** buttons, various channel lists sorted alphabetically and numerically (based on the channel name) can be selected

TEXT button: Open the search function - search for channel name

TVR (blue) button: Open the radio channel list (usage identical to the TV channel list)

i button: Open the signal strength and signal quality and other information on the channel (see box on the right in the figure above)

OPERATION



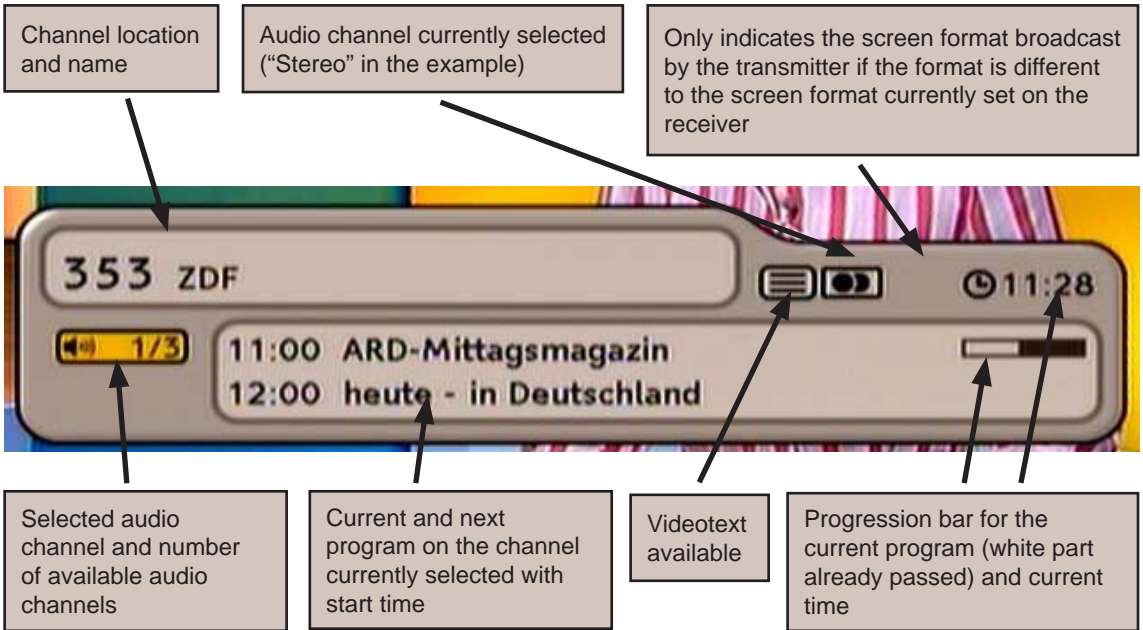

Select the required channel using the     buttons and press the  button.

BANNER





When you switch channels the following information is displayed on-screen:

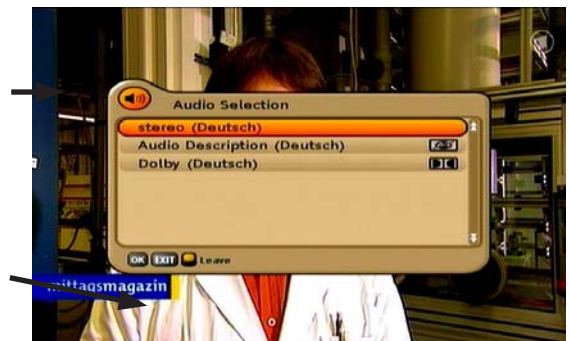

AUDIO/SUBTITLE SELECTION





Press the  (yellow) button once (twice for portal channels) to view further soundtrack selection options, if these are transmitted by the channel provider. Use the   buttons to scroll through the available selection options. By pressing the  (yellow) button again, you can open the menu for selecting the subtitles, if available.



The sub-titles are also selected using the   buttons. Press the  (yellow) button again, or press the  button to exit this display again.

OPERATION



OPENING OPTIONS CHANNEL

If the channel OSD contains the following icon , this is a portal channel. Press the  (yellow) button to display the channels available on this portal (such as matches on a specific day of play). In this example three “sub-channels” are available for selection within this portal channel. Select the channels using the   buttons and .

PICTURE SCALING AND AUDIO OUTPUT FORMAT





By pressing the  (green) button you can change the following settings directly on the TV screen, without having to open the main menu:



- **Picture Scaling:** Select using the  (red) button. The possible settings depend on the setting you made on the “Box Settings”, “TV picture settings”.
- **HD Video Resolution:** Select using the  (blue) button. Select the setting suitable for your TV set (note the information in the operating instructions for your TV set).
- **Audio Format:** Select using the  (green) button. You can choose between the settings Stereo, Mono (left), Mono (right) and Mono.



The display disappears again automatically after approx. five seconds.

TELETEXT

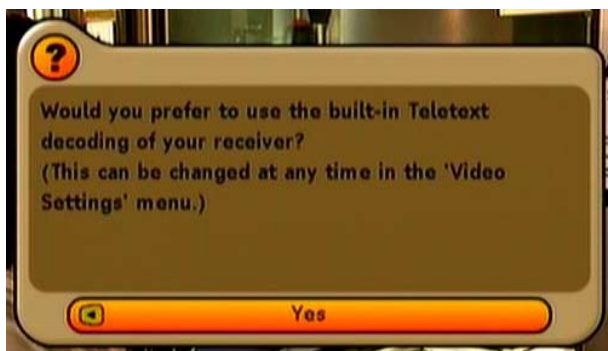
Press the  button to open Videotext. When Videotext is opened for the first time you will be asked whether you wish in future to open Videotext using the receiver remote control or, as usual, using the TV set remote control (see screenshot below). Use the   buttons to select the desired variant and press the  button to confirm.



When using Videotext via the receiver remote control:

You can open the required Videotext page using the number pad. You can scroll forward or back one page using the   buttons.

Pressing the  button again renders the Teletext display transparent.

To leave the Videotext, press again the  button or the  button.

EPG (ELECTRONIC PROGRAM GUIDE)

OPENING THE EPG



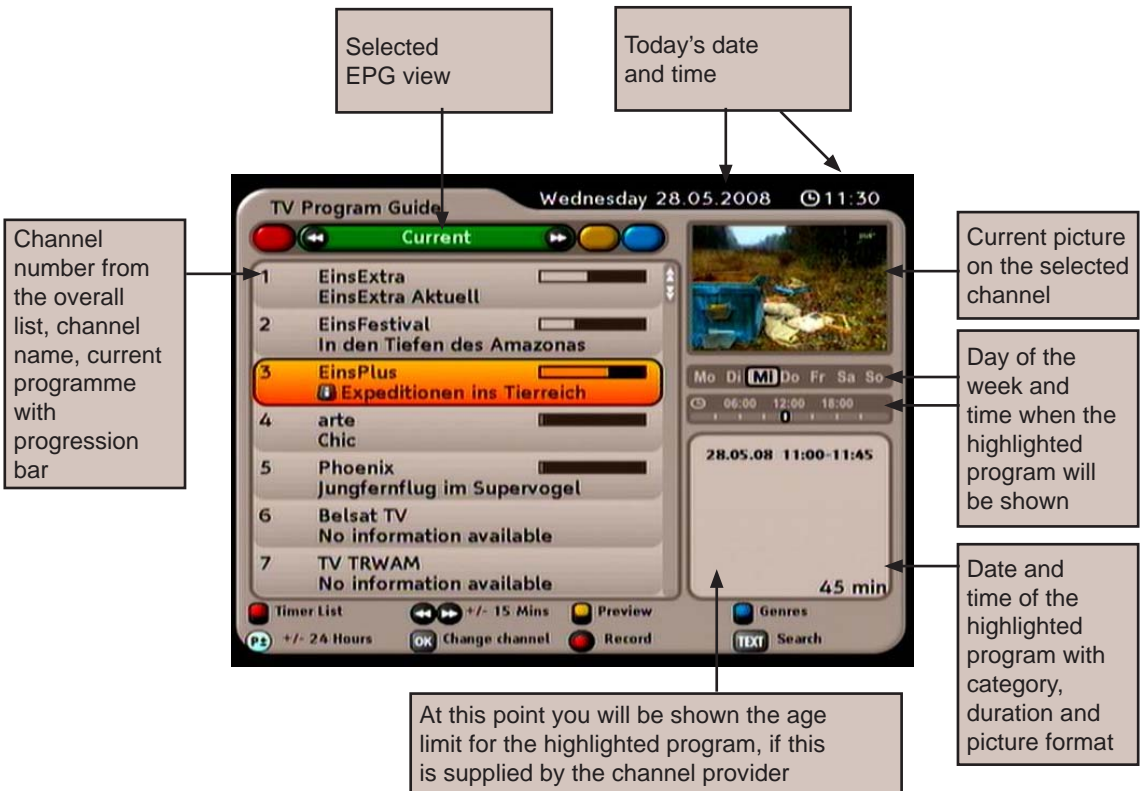







The EPG is opened by pressing the  button. Each time the EPG is opened, you will automatically be shown the "Current" view, irrespective of which view you were shown the last time you left the EPG. The following display appears (example):











Note: *If you had selected a favourite list before opening the EPG, you will see in the EPG only the data for the channels that are included in your favourite list. Press the  button again to display the EPG for all channels.*

EPG (ELECTRONIC PROGRAM GUIDE)

Selection options:

-  (red) button Open the timer list (display of all pre-programmed recordings)
-  button Jump forwards in the “Current” view by 15 minutes. Press the button (rewind) to jump back in 15 minute steps to the current time.
-  (yellow) button Open a preview of the currently highlighted channel
-  (blue) button Open the category selection (sorting the programs by categories such as movies, sport, series ...)
-  button (P+) jump forwards 24 hours in the EPG, (P-) jump backwards 24 hours in the EPG (e.g. in “Current” and in “Preview” view)
-  button Select the currently highlighted channel in all views. Pressing again the  button or the  button closes the EPG and the selected channel is shown again on the TV screen
-  (red dot) button Add a programme to the recording settings
-  button Search for a particular program or program content (enter the search expression using the number pad on the remote control, see also the section “Operating instructions”, “Alphanumeric input”)
-  button Show, if present, further information on the selected programme.

Navigation within each EPG view is always performed using the cursor buttons (   ).

The   buttons allow you to select individual channels/programs, and the   buttons allow you to scroll from page to page of the currently selected list.

Pressing the  or the  button exits the EPG again and returns to the TV picture.



You will see information on the current or next following programmes in the EPG only if it is supplied by the channel provider. If no EPG data are available the receiver, instead of showing information on the current program, shows the message “No data available!”.

“CURRENT” VIEW

The “Current” view can be opened at any time in the EPG by pressing the  (green) button. This view is automatically displayed every time the EPG is started (see screenshot “Opening EPG”).

In the “Current” view you can see all channels displayed in the order of the overall channel list. Provided that EPG data has been supplied by the channel provider, the receiver shows for each channel the current program being shown, with start time, finish time, and progression bar.

EPG (ELECTRONIC PROGRAM GUIDE)

You can use the cursor buttons (▲▼◀▶) or the number pad buttons to select the desired channel and, if available, you can use the ⓘ button to open further information on the desired program. The ▶ button allows you to look ahead in 15 minute steps to future programs on the channels (press the ◀ button to return to the current time).

If you wish to view the program currently being shown on a channel, you need not to exit the EPG, just select the desired channel and press the OK button. At the top right of the screen you will see the current TV picture for the selected channel. The picture only appears once the OK button has been pressed. What you saw before was the picture of the old channel that had previously been selected, even though the EPG was no longer set to that channel.

“PREVIEW” VIEW (PROGRAMME MAGAZINE)

The “Preview” view (programme magazine) can be opened at any time in EPG by pressing the OPT (yellow) button.



Also note the bars at the bottom of the on-screen display! These provide information on what to do next.

In the “Preview” view you will see all the programmes that will be shown in the previous “Current” list of selected channels. Provided that EPG data has been supplied by the channel provider, the receiver displays the programmes that will be shown on the selected channel for several days in advance.

You can use the cursor buttons (▲▼◀▶) to select the desired programme and, if available, you can use the ⓘ button to open further information on the desired programme.

You can use the ◀▶ buttons to scroll through the programs in the order of the overall list of programs (the programs can also be selected by entering digits with the number pad); you remain however in “Preview” view.

The ⏮ button allows you to scroll backwards and forwards a day at a time.

Using the ● (red dot) button you can copy the selected programme to the recording settings (see “Recording” section).

EPG (ELECTRONIC PROGRAM GUIDE)







CATEGORIES VIEW

The “Categories” view can be opened at any time in EPG by pressing the  (blue) button.



In the “Categories” view you can see all programmes sorted by category and starting time. The following categories are available for selection: Movies, Series, Sport, Children’s programmes, Entertainment, Current affairs, Reportage, Art & Culture, Education, Music, Leisure and Adult.

Programmes can be assigned to the above categories only if the EPG data has been supplied by the channel provider.

Select the required category using the   buttons. You can then use the cursor buttons (, , , ) to select the desired category and, if available, you can use the  button within each category to open further information on the desired programme.

The  button allows you to scroll backwards and forwards a day at a time.

Using the  (red dot) button you can copy the selected programme to the recording settings (see “Recording” section).

EPG (ELECTRONIC PROGRAM GUIDE)



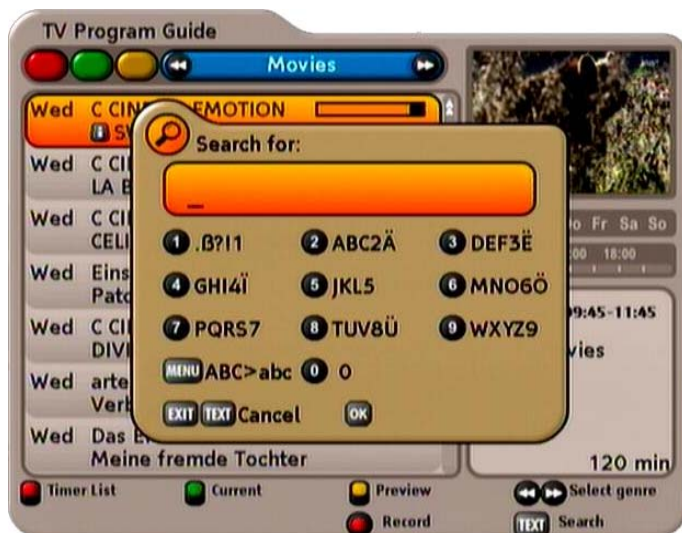

SEARCH FUNCTION

The search function can be opened at any time in EPG by pressing the  button.



The search function allows you to search for programmes based on their additional information or their name. Use the number pad to enter the desired search expression (see also "Operating Instructions" "Alphanumeric Input").

When you have entered the desired search expression, press the  button to start the search.

You can then use the cursor buttons (, , , ) to select the desired programme from the search result and, if available, you can use the  button to open further information on the desired programme.



Using the  (red dot) button you can copy the selected programme to the recording settings (see "Recording" section).

EPG (ELECTRONIC PROGRAM GUIDE)

ADDITIONAL INFORMATION (i BUTTON)

The additional information can always be opened by pressing

the **i** button whenever the “i symbol” appears in front of the program name (see screenshot on the right). First however the channel must be selected. The following display appears (example):

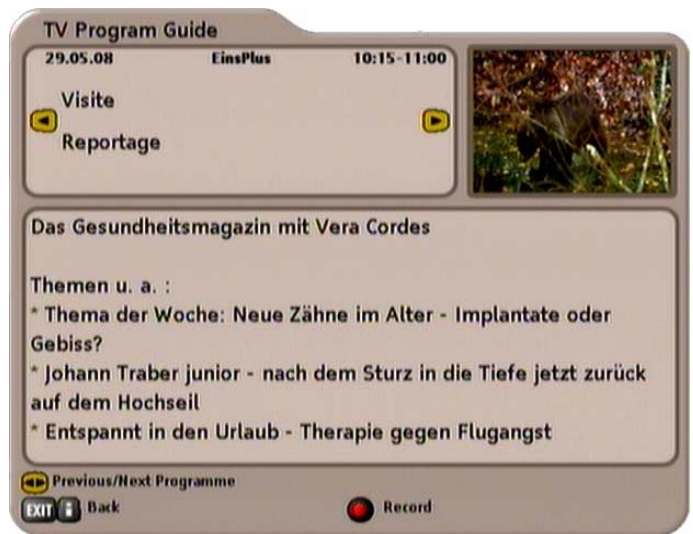

The additional information available for a programme is displayed in its own window. By pressing the

i button, if available, you can open further additional information on the selected programme.

The **◀▶** buttons enable you to display the additional information for the preceding or following programmes in the order of the previously selected list (see header). This feature always assumes that the data has been supplied by the channel provider.

Using the **●** (red dot) button you can copy the selected programme to the recording settings (see “Recording” section).

Press the **i** or the **EXIT** button to exit the additional information.

EPG (ELECTRONIC PROGRAM GUIDE)

RECORDING (TIMER)

The  (red dot) button allows you to set up a program at any time for recording on an external recorder.

The programme to be recorded can be selected in any of the EPG views, provided the  (red dot) button appears at the bottom of the screen display.



Programme present in the EPG:

Select the desired programme and press the  (red dot) button. The following display appears (example):



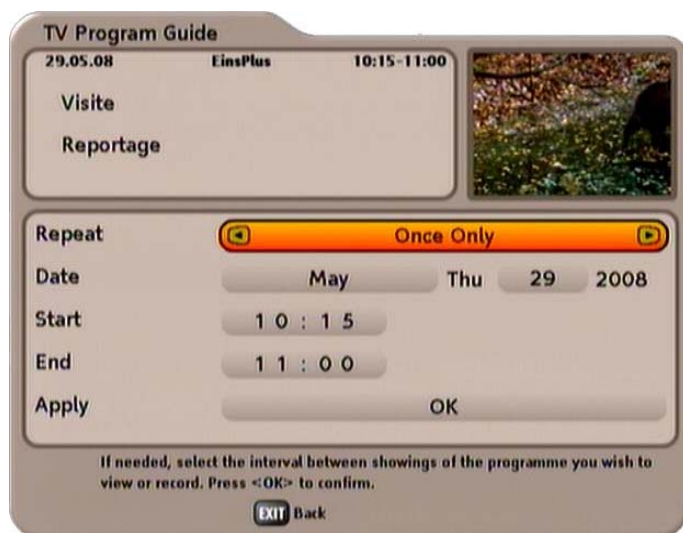
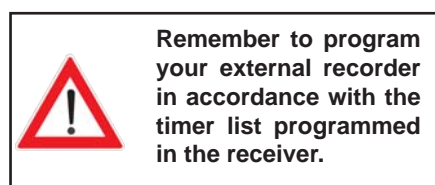

Programme not present in the EPG:

Select any programme on the channel on which the desired programme is to be transmitted at a later time and press the  (red dot) button (starting and finishing times together with the recording date must be input manually). The following display appears (example):



Use the   buttons to select the desired recording mode (cyclical). The following recording mode options are available:

- **Once:** The recording will be performed once
- **Daily:** The recording will be performed daily at a time specified by you
- **Weekly:** The recording will be performed once a week on the same day and at the same time
- **Monday to Friday:** The recording will be performed Mon-Fri at the specified time

Use the cursor buttons     to select the further items and use the number pad to complete the settings. When all settings have been made, press the  button to save the recording settings. You can view the scheduled recordings in the timer list view of the EPG (see section "Timer list").

EPG (ELECTRONIC PROGRAM GUIDE)

RECORDING ONCE ONLY

Use the ◀▶ buttons to select the repeat "Once Only" (see screenshot "Recording (Timer)" section).

Use the ▲▼ buttons to switch to the selection field "Date" and use the ◀▶ buttons to select the desired recording month.

Then use the ▲▼ buttons to switch to the selection field "Day" (e. g. 03.2008) and select the day in this month on which the recording is to start using the ◀▶ number pad buttons. Use the ▲▼ buttons to switch to the selection field "Start" and use the ◀▶ buttons or the number pad buttons to select the desired recording start time.

Use the ▲▼ buttons to switch to the selection field "End" and use the ◀▶ buttons or the number pad button to select the desired recording end time. Once all settings have been made, use the ▲▼ buttons to switch to the selection field "Apply" and press the OK button to save the recording settings. You can view the scheduled recording in the EPG's timer list view (is opened automatically) (see "Timer list" section).

RECORDING DAILY

Use the ◀▶ buttons to select the recording mode "Daily" (see screenshot below).

Use the ▲▼ buttons to switch to the selection field "Start" and use the ◀▶ buttons or the number pad buttons to select the desired recording start time.

Use the ▲▼ buttons to switch to the selection field "End" and use the ◀▶ buttons or the number pad button to select the desired recording end time.

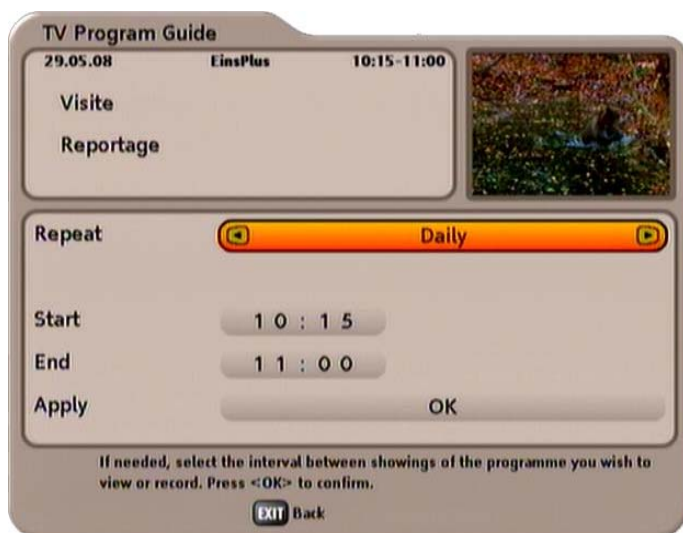

EPG (ELECTRONIC PROGRAM GUIDE)

When all settings have been made, press the **OK** button to save the recording settings. You can view the scheduled recording in the EPG's timer list view (is opened automatically) (see "Timer list" section).

RECORDING WEEKLY



Remember that the day of the week for the desired programme is copied to the timer list and you can make no further manual corrections to it! Therefore before pressing the **● (red dot) button, select the programme on the day of the week that in future you will wish to make the weekly recording.**

Use the **◀▶** buttons to select the recording mode "Weekly" (see screenshot below).

Use the **▲▼** buttons to switch to the selection field "Start" and use the **◀▶** buttons or the number pad buttons to select the desired recording start time.

Use the **▲▼** buttons to switch to the selection field "End" and use the **◀▶** buttons or the number pad button to select the desired recording end time.

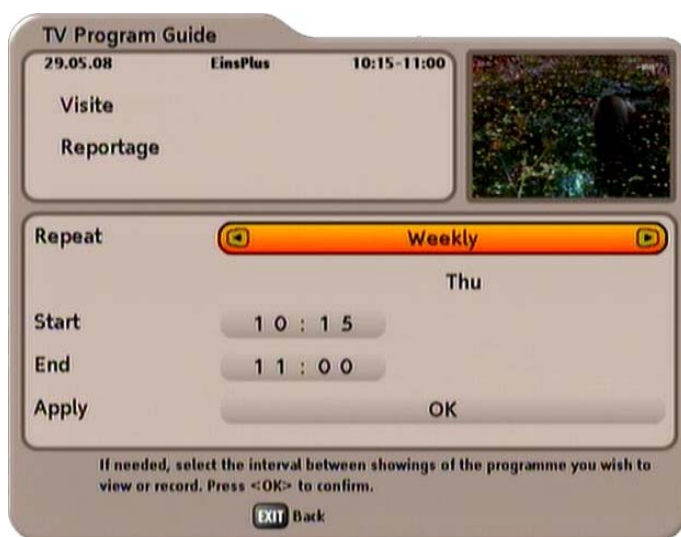

Once all settings have been made, use the **▲▼** buttons to switch to the selection field "Apply" and press the **OK** button to save the recording settings. You can view the scheduled recording in the EPG's timer list view (is opened automatically) (see "Timer list" section).

EPG (ELECTRONIC PROGRAM GUIDE)

RECORDING MONDAY TO FRIDAY

Use the ◀▶ buttons to select the recording mode “Monday - Friday” (see screenshot below).

Use the ▲▼ buttons to switch to the selection field “Start” and use the ◀▶ buttons or the number pad buttons to select the desired recording start time.

Use the ▲▼ buttons to switch to the selection field “End” and use the ◀▶ buttons or the number pad button to select the desired recording end time.

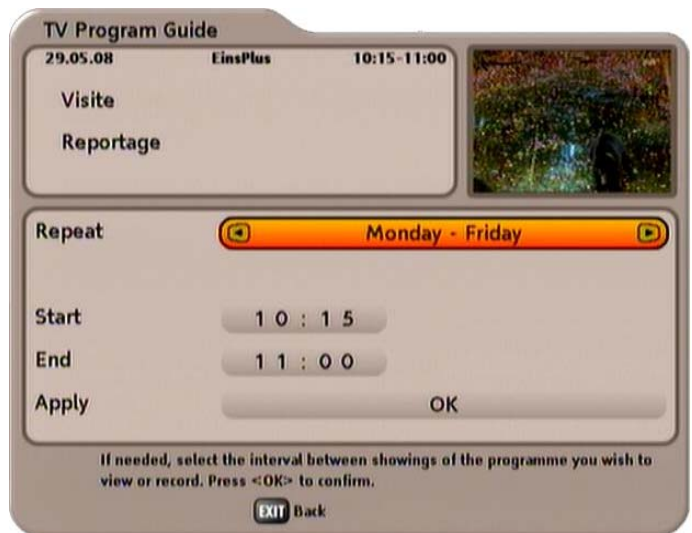

Once all settings have been made, use the ▲▼ buttons to switch to the selection field “Apply” and press the OK button to save the recording settings. You can view the scheduled recording in the timer list view of the EPG (see section “Timer list”).

EPG (ELECTRONIC PROGRAM GUIDE)



TIMER LIST VIEW



The “Timer list” view can be opened at any time in EPG by pressing the  (red) button.



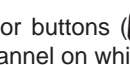

The timer list view shows you all the recordings that are scheduled.

The  buttons allow the recordings to be sorted into “Once” or “Repeated” recordings.

The cursor buttons () allow you to select a recording. The  button allows you to switch to the channel on which the recording is scheduled.

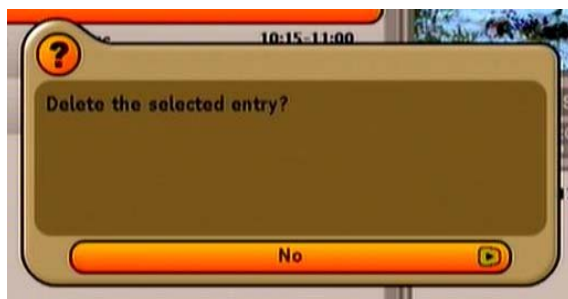
The  (red dot) button allows you to delete a recording that had been scheduled. If this is a series recording you will additionally be asked whether you wish to cancel the recording of only one episode or whether you wish to record no further episodes of this series (see screenshot). Selection is performed using the  buttons and is confirmed using the  button.



The  button allows you to skip backwards and forwards through the future scheduled recordings, a day at a time.

COMMON INTERFACE

IMPORTANT INFORMATION

Always follow the operating instructions from your pay TV provider and the instructions supplied with the Smartcard and the CA module!

Smartcards and CA modules are not included with this product!

The cards and modules are issued by the respective Pay TV providers, and contain the subscriber data and details of the channels for which the subscriber has paid. These channels are always scrambled.

Contact the Pay TV provider if you are interested in subscribing to a particular Pay TV channel.

You are responsible for the use of the Smartcard in the CA!

The Smartcard sold by the Pay TV provider, specific to a particular encryption technology, is inserted into the CA module.

Store your card and PIN code securely when not in use!



INSERTING THE SMARTCARD AND THE CA MODULE

INSERTING THE CA MODULE INTO THE CI

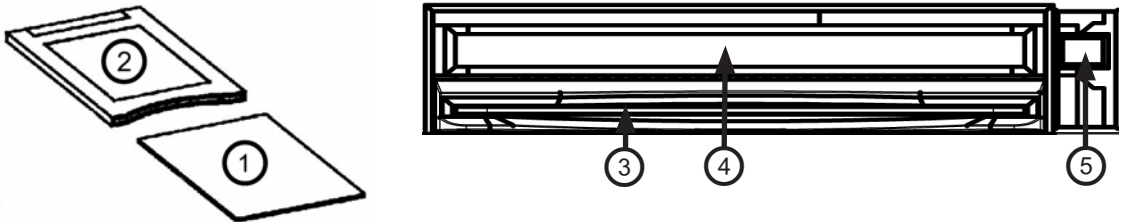

The Common Interface (CI) (4) on the UFS 733si/sw can accept one CA (Conditional Access) module. The CI slot is under the display at the right of the front panel.

The CA module (2) draws in the Smartcard (1) (chip contacts pointing downwards and towards socket strip) which it then inserts into the CI slot (4).

The Smartcard should be inserted into the CA module without exerting excessive force. This also applies to inserting the CA module into the CI slot.

Do not use without excessive force, and follow the instructions supplied with the Smartcard and the CA module.

To remove the module, press the relevant eject button (5).

INSERTING THE SMARTCARD INTO THE SMARTCARD READER

The Smartcard is inserted into the Smartcard reader (Cryptoworks embedded) (3) in exactly the same way as into the CA module, except that in this case the chip contacts point downwards.

MAIN MENU

Press the  button to open the main menu. The following display appears:

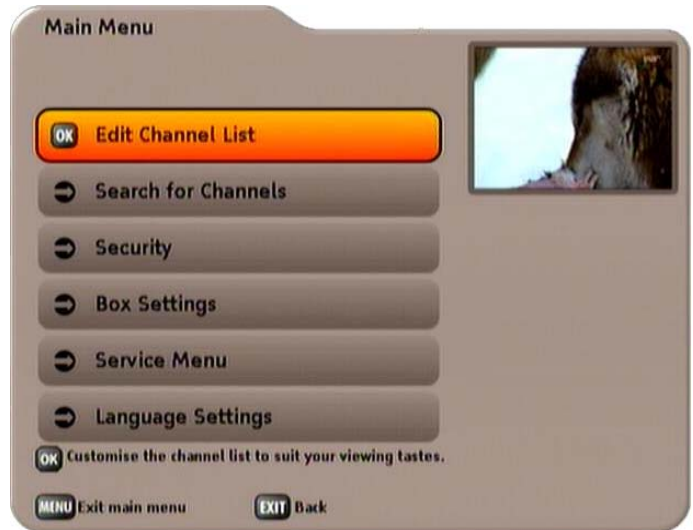

Six sub-menus are available. These are explained below:

1) Edit Channel List

Sort and delete channels in the channel list or favourite list, copy channels from the channel list to the favourite lists

2) Search for Channels

Various searches, LNB setting and sat finder

3) Security

Lock various menus, the device, channels and change the device's PIN code

4) Box Settings

Various settings for video, menu, Common Interface; LNB and antenna (DVB-T)

5) Service Menu

Sat finder, channel information, system information and reset to the factory setting

6) Language Settings

Language selection for menus and languages; subtitle settings; lock various menus and change the device's code





Select the required sub-menu using the   buttons and press the  button.

EDITING CHANNEL LIST

Use the  (blue) button to switch between the TV and radio channels. The change is made in the same way for TV and radio channels.





SORTING CHANNELS IN CHANNEL LIST (LEFT COLUMN)

Use the  buttons to select the channel you want to move, then press the  button. The channel name is displayed in bold and indented from the left margin. Now select the new channel location for the highlighted channel using the  buttons. Save the channel in the new channel location by pressing the  button again.

DELETING CHANNELS FROM CHANNEL LIST

Note: *A channel deleted from the channel list (left column) is also deleted from the favourite lists and can only be found again by performing a channel search again.*

Use the  buttons to select the channel you want to delete and press the  button. The channel immediately disappears from the channel list; no confirmation message is issued.

FAVOURITE LISTS

Four favourite lists for TV and radio channels are available. You can copy up to 200 channels to each of these favourite lists.

EDITING CHANNEL LIST

ADDING A CHANNEL TO FAVOURITE LIST

Before you start to assign channels to favourites lists you can filter the existing channels using certain criteria. Press the ^{OFF} (yellow) button to open the "Filter channels" menu:

Use the **▲▼** buttons to select the lines to be changed and use the **◀▶** buttons to perform the settings.



Once all the settings have been made, switch to the "OK" line and press the **OK** button to apply your settings. The following display appears (example):

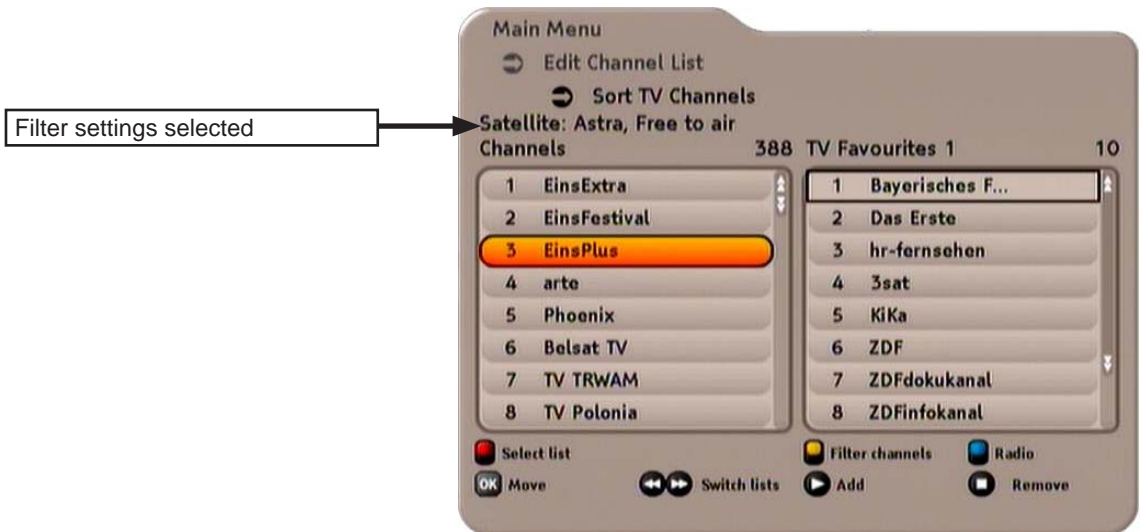







EDITING CHANNEL LIST



Selection of the favourite list:

First select using the  (red) button, to which of the four favourite lists you want to copy a channel.



Selection of the channel location in the favourite list:



A channel newly added to the favourite list is always inserted after the channel currently marked with a black box on the favourite list. To insert a channel at a specific point in the favourite list, you must switch to the favourite list using the  button and select the channel location after which the channel is to be inserted using the  buttons. Then switch back to the channel list using the  button.

Copying channel to the favourite list:



Use the  buttons to identify the desired channel in the channel list that you wish to load into the favourites list. Press the  button and channel is inserted at the selected position in the selected favourite list.











DELETING A CHANNEL FROM FAVOURITE LIST





First select using the  (red) button, from which of the four favourite lists you want to delete a channel. Then switch to the favourite list using the  button.

Use the  buttons to select the channel you want to delete and press the  button. The channel disappears immediately from the favourite list, without any confirmation of the deletion, (channel is **not** deleted from the channel list).

SORTING CHANNELS IN FAVOURITE LIST

First select using the  (red) button, which of the four favourite lists you want to sort. Then switch to the favourite list using the  button.

Use the  buttons to select the channel you want to move, then press the  button. The channel name is displayed in bold and indented from the left margin. Now select the new channel location for the highlighted channel using the  buttons. Save the channel in the new channel location by pressing the  button again.

On leaving the "Edit Channel List" menu ( button) you will be prompted by the receiver as to whether you want to save the changes (select "Yes"), cancel the action (select "Cancel") or if you do not want to save the changes (select "No"). Make the selection using the  buttons and confirm using the  button. The Main Menu will open again.

SEARCH FOR CHANNELS

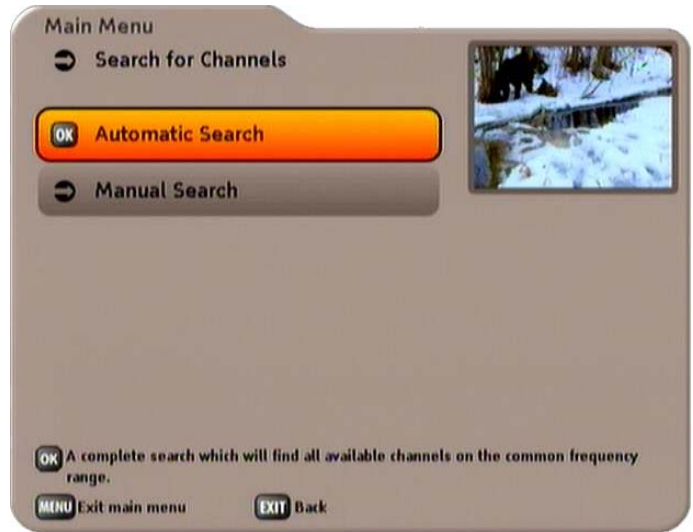

Use the **▲** **▼** buttons to select the operation mode for which you want to start a search. The options are DVB-S (sat) and DVB-T (terrestrial). Confirm your selection with the **OK** button.

You can now select whether you want to start an automatic search or a manual search.

Automatic Search:

Here you can set whether the search is to cover one satellite or all satellites and the channels for the search.

Manual Search:

Here you have several setting options for starting a selective search.

SEARCH FOR CHANNELS

AUTOMATIC SEARCH



When selecting the satellite, ensure your reception system is actually aligned with this satellite.

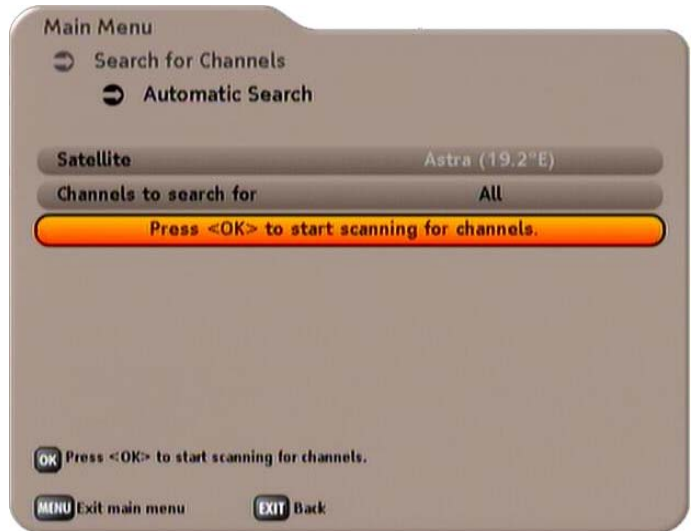

Change to “Satellite” using the buttons. Use the buttons to select whether you want the search to cover all satellites you have setup or only one specific satellite. Using the buttons switch to “Channels to search for” and select whether you want to search only for free-to-air channels, only for encrypted channels or for all channels using the buttons. Once you have made all the settings, switch to the last line and start the search using the button. The following display appears:



SEARCH FOR CHANNELS

After completion of the search, you will see the following message:



Use the buttons to select whether you wish to add new channels to the old ones or to discard the new channels. Press the button to confirm your selection. The new channels you have found and saved are marked in the channel list (open from the TV screen using the button) with an "N" after the channel name (see example):



SEARCH FOR CHANNELS

MANUAL SEARCH

Using the setting “Network search On”, additional transponders, not yet saved can be found by the networking of the transponders. They are then stored and searched for new channels in the same way as the existing transponders.



Use the buttons to select which satellites you want to cover with a search.

Use the buttons to switch to “Transponder” and select the transponder to be covered by the search using the buttons. You can also manually enter the transponder frequency, the symbol rate and the polarisation in the next three lines using the number pad buttons or using the buttons.

Use the buttons to switch to “Network search” and use the buttons to select whether the additional transponders, not yet saved, found due to the networking of the transponders are also be searched for new channels.

Using the buttons switch to “Channels to search for” and select whether you want to search only for free-to-air channels, only for encrypted channels or for all channels using the buttons.

Once you have made all the settings, switch to the last line and start the search using the button. The displays once the search is complete are identical to those for the automatic search.

SECURITY

Press the **MENU** button to open the main menu. Select the “Security” menu using the **▲▼** buttons and press the **OK** button. Enter the receiver PIN (factory setting “0000”) and confirm it by pressing the **OK** button. The following display appears (see example below):

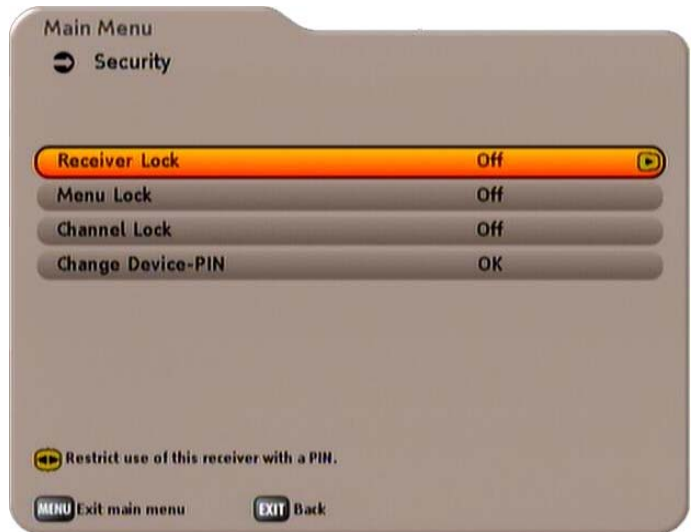

Use the **▲▼** buttons to select the lines to be changed and use the **◀▶** buttons to perform the settings.

Receiver Lock:

If the receiver lock is set to “On”, when the receiver is switched on it will request input of the PIN.

Menu Lock:

If the menu lock is set to “On”, the PIN must be entered as soon as the main menu is opened.

Channel Lock:

If the channel lock is set to “On”, the PIN must be entered as soon as a channel is opened that has been marked as locked in “Edit Channel List”.

Change Device-PIN:

Press the **OK** button – you will be requested to enter the old PIN. Confirm the entry of the old PIN using the **OK** button. Now enter the new PIN and confirm by pressing the button. Then you must enter the new PIN again and also confirm using the **OK** button. “The receiver PIN has now been changed” is displayed. Press the **OK** button to close the message.

BOX SETTINGS



Press the **▲** **▼** buttons to select the desired menu. Open the menu using the **OK** button.

- 1) **Video Settings**
Definition of the video settings
- 2) **Menu Settings**
Definition of various menu settings
- 3) **Miscellaneous Settings**
Definition of time zone and audio output formats
- 4) **Conditional Access**
Access to the Smartcard reader and to the Common Interface
- 5) **LNB Type**
LNB settings, on this topic see First installation page 13ff

BOX SETTINGS

VIDEO SETTINGS

Also note the bars at the bottom of the on-screen display! These provide information on what to do next.



Use the **▲▼** buttons to select the line you want to change. Use the **◀▶** buttons to make the changes.

Screen Format:

Select your TV's format here. Either 4:3 or 16:9/wide screen TV

Picture Scaling:

Select here how the picture from the channel provides is to be adjusted by the receiver if it does not match your setting (4:3 or 16:9).

For screen format 4:3: Either Letterbox 14:9, Letterbox 16:9 or Pan & Scan/CCO

For screen format 16:9: Always 16:9 or Automatic

HDMI Output:

If your receiver is connected to an HDTV using an HDMI cable, press the **OK** button to make the settings.

The following settings are then available (make the selection using the **▲▼** button and the settings using the **◀▶** buttons):

- Image resolution: 576i, 576p, 720p and 1080i
- Test of coloured bars: Press the **OK** button to perform a test of coloured bars (only output over HDMI)
- HDMI audio: "On" (digital audio is transmitted over HDMI) or "Off" (digital audio is not transmitted over HDMI)
- Digital volume control: "On" or "Off"

Press the **EXIT** button to exit the "HDMI Output" sub-menu.

BOX SETTINGS

TV Output Format:

Select the type of video signal that is to be at the Scart socket here. Select the signal that your TV set can process.

Refer to the operating instructions for your television set!

You can choose between the following settings: RGB (Red/Green/Blue signal), S-video (luminance/chrominance) and CVBS (Colour Video Baseband Signal)

VCR Output Format:

You can choose from the following settings: S-video and CVBS

AFD Automatic:

This setting corrects the screen format automatically if the broadcast screen format varies from that displayed



Teletext:



You can select whether the Videotext is controlled by the TV remote control (external, Videotext signal is processed by the TV set) or by the receiver remote control (internal, Videotext signal is processed by the receiver).

Restore Default Settings:

Here you can restore the default settings for video and audio

MENU SETTINGS

Use the   buttons to select the line you want to change. Use the

  buttons to make the changes.

Info Banner Duration:

Here you can set the following banner display times: "Permanent", "None" and then in 1-second steps up to 15 seconds.

Info Banner Automatic:

Here you can set whether the info banner is automatically displayed at the start of a broadcast or not.

Menu Language:

Here you can set the following menu languages: German, English, French, Spanish, Italian, Czech, Dutch and Turkish.

To quit the menu and save the changes, press the  button.



BOX SETTINGS

MISCELLANEOUS SETTINGS



Use the **▲▼** buttons to select the line you want to change. Use the

◀▶ buttons to make the changes.

Time Zone Adjustment:

Here you can set whether the time zone is set automatically or manually.

Time Zone (GMT):

Here you can set the time zone manually.

Summertime / DST:

You can switch summer time on and off using this menu item.

Audio Format:

Select the audio output format here. You have the choice between "Mono (from the right channel)", "Mono (from the left channel)", "Mono (total)" and "Stereo".

Dolby Digital Automatic:

Here you can select whether the receiver should automatically deliver Dolby Digital sound (when broadcast) to the Dolby Digital output.

Audio Delay:

Here you can select whether the sound should be output with a delay of (100/200/300/400 or 500 milliseconds). You can use this setting in the event that the sound and picture are not output synchronously on the TV set. If no delay is required, set the delay to "None".

Sorting:

Here you can specify the sorting of the channel lists.

You can choose between "A to Z" or "Z to A" (each alphabetic), "Provider" (e. g. ZDF or ORF) and the service ID.

Standby Display:

Select here whether the receiver display is to indicate the time or remain dark (nothing is displayed) when the receiver is in the standby mode.

To quit the menu and save the changes, press the **EXIT** button.

BOX SETTINGS

CONDITIONAL ACCESS (COMMON INTERFACE)

Press the **MENU** button to open the main menu. Select the "Conditional Access" menu using the **▲▼** buttons and press the **OK** button. The following display appears:

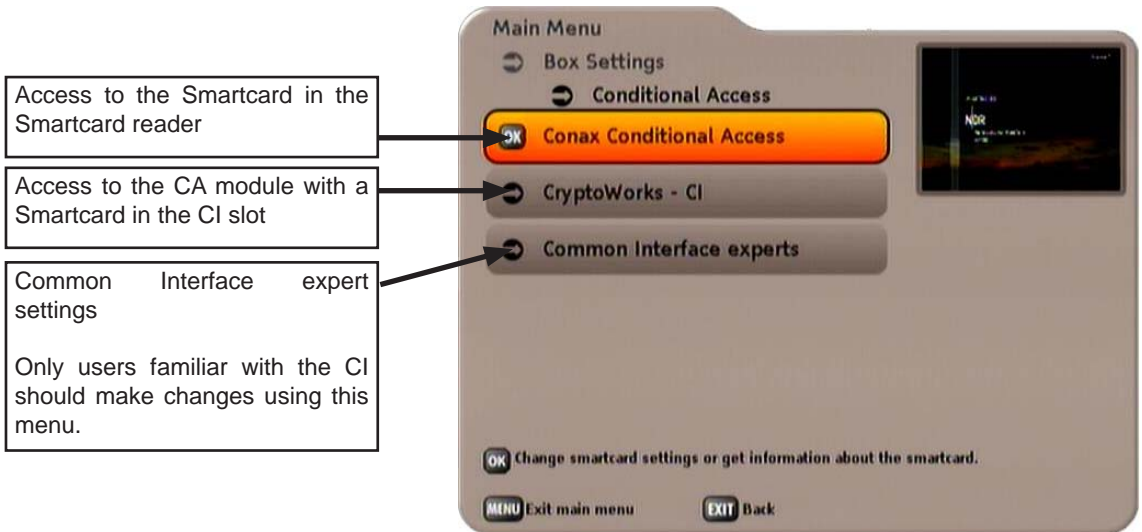

CONAX CA - SMARTCARD READER

Press the **OK** button to open the menu. The following display appears:



Use the **▲▼** buttons to select the desired menu, and press the **OK** button to open it. The menus depend on the Smartcard that is used. Please follow the instructions and information displayed by the receiver.

BOX SETTINGS

MODIFY MATURITY RATING

Use the **▲▼** buttons to select the “Smart card management” menu, and press the **OK** button to open it. If required, enter the Smartcard PIN code.



When you first select an encrypted channel the receiver will display a screen requesting that you set up a maturity rating. If you do not set up any maturity rating, you will see this notice again when next you select an encrypted channel.

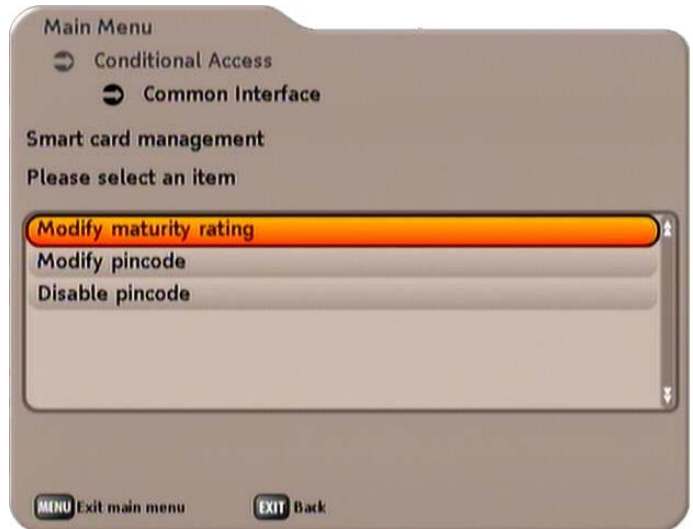

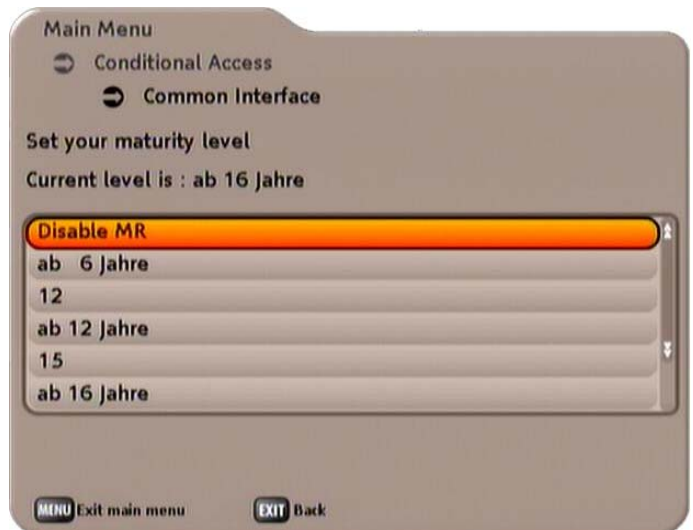

Use the **▲▼** buttons to select the “Modify maturity rating” menu, and press the **OK** button to open it.



Use the **▲▼** buttons to select the desired maturity level. Press the **OK** button to apply your selection.

BOX SETTINGS

CRYPTOWORKS - CI (CA MODULE)

This menu informs you which CA module is fitted to your receiver and which Smartcard is present in the CI slot. Select the "CryptoWorks - CI" menu using the   buttons and press the  button to open it. You will then see the menu generated by the CA module.

The screenshots below depend on the specific module and card, and so are only intended as examples:

Note: *The module displays may be shown in English, even if you have selected German as the menu language, because the menu is generated directly by the module!*

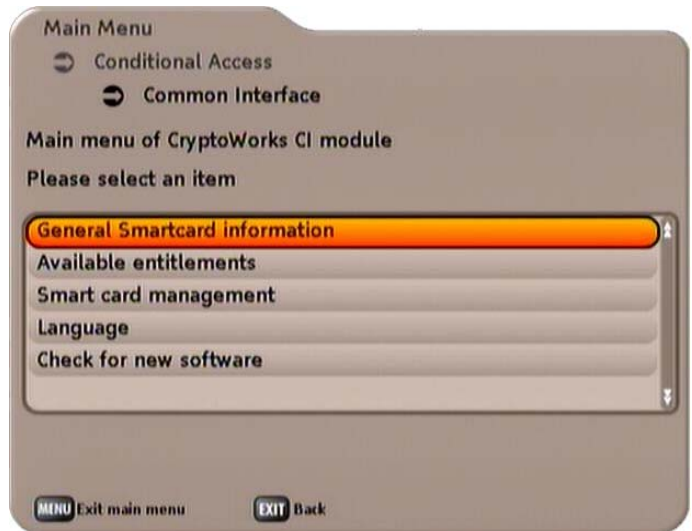

From this menu, your card and your PIN code allow you to access various channels from your Pay-TV provider.

"CryptoWorks" has been selected as an example here. The details can be different for each CA module. Always follow the instructions supplied by your pay TV provider!

Information for Conax, SECA, Viaccess and CryptoWorks users:

Note that with monthly activation intervals, the channel providers have different procedures for activating pay TV cards. Activation may therefore be a few days before or after the beginning of a new month. During this activation period, the CA module and card must be in the slot, and the receiver must be turned on and set to the booked Pay-TV channel. Follow the instructions from the pay TV provider.

If your pay TV card is then still not enabled, we recommend you briefly withdraw the CA module with the card out of the slot, with the receiver switched on, and then re-insert it.

This information has nothing to do with the properties of the unit; it is merely intended to assist you.

The various items can be selected using the   buttons and opened using the  button. Press the  button to exit the menu.

BOX SETTINGS

LNB SETTINGS

See "First Installation" section page 13ff.

SERVICE MENU



Press the **▲** **▼** buttons to select the desired menu. Open the menu using the **OK** button.

1) Sat Finder

Check the satellite signal strength and reception quality, which can also be used for the coarse alignment of a satellite reception system

2) Channel Information

Display information on the channel currently selected, e. g. service ID, audio and video PID) etc.

3) System Information

Display information on device hardware and software, software download

4) Restore Factory Settings

All receiver settings can be reset to the factory settings

SERVICE MENU

SAT FINDER

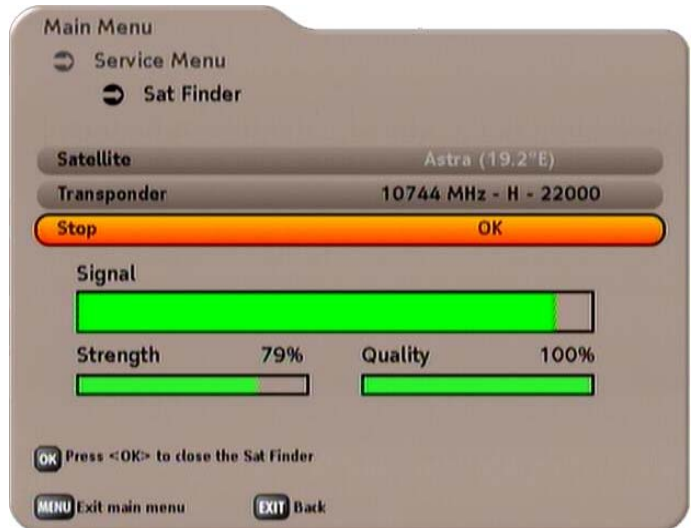

If you do not have a meter for adjusting your reflector, you can use the sat finder as an alignment aid. You can select the different lines using the buttons. Make changes in the lines using the buttons (e. g. transponder). Once you have a good reception signal (see example above), press the button in the "Exit" line.

CHANNEL INFORMATION

You cannot change or delete any data here. This menu is merely for viewing the reception data for the currently selected channel.

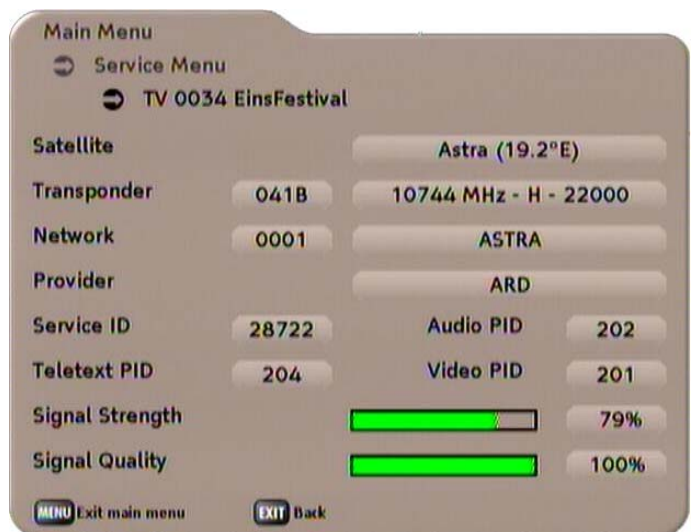

SERVICE MENU

SYSTEM INFORMATION

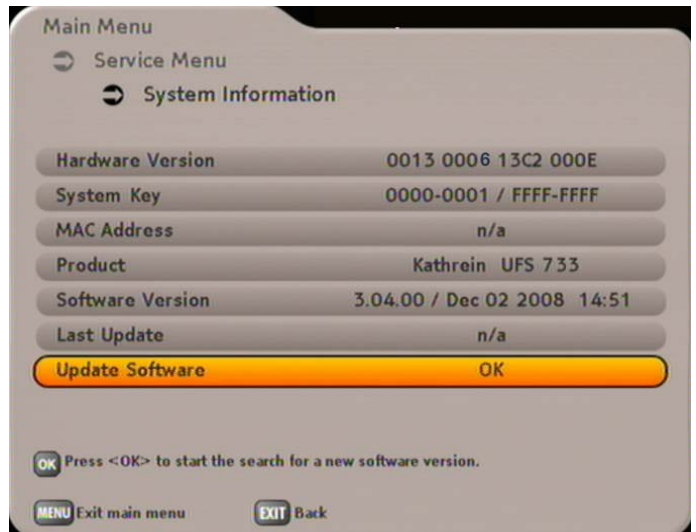

In the “System Information” menu, the receiver displays information regarding its hardware and software versions.

UPDATING SOFTWARE

As soon as the receiver is switched into stand-by mode, it automatically checks whether new software/a new servicelist is available for downloading. If new software/a new servicelist is available for downloading, you will see the following display:

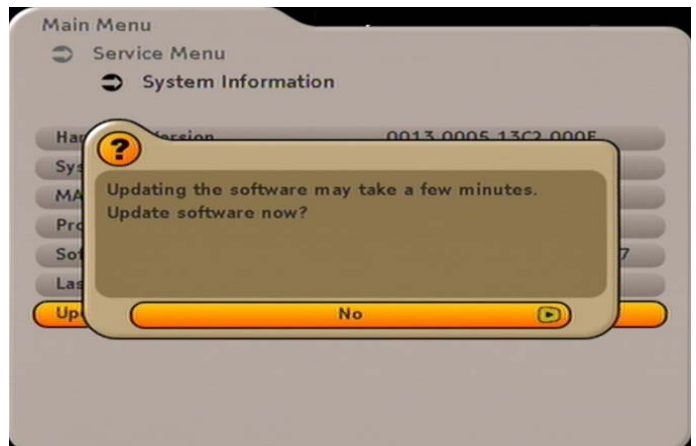



Use the buttons to select “Yes” if you wish to update the software now, or “No” if you wish to update the software at a later time. Confirm your selection with the button.

SERVICE MENU

UPDATE SOFTWARE NOW

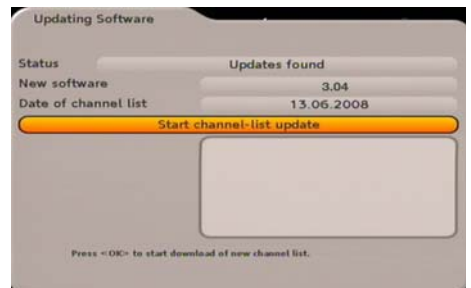
The following displays appear:





If as well as the new software a new servicelist for the receiver is also offered, you have the following selection options (use the   buttons to make the selection):

- "Start update software"
- "Start update servicelist"
- "Start update servicelist and software"

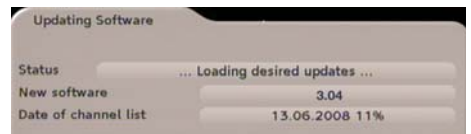
Confirm the desired selection with the  button. The following display appears (example):



When updating the servicelist, before installation you will see a display in which you can select how the servicelist should be updated (use the   buttons to make the selection).

You can choose between:

- "Overwrite" - your existing servicelist will be completely replaced by a new list of available channels. Your personal channel sorting will be lost.
- "Update" - your existing list will only be updated, any new channels found will be added at the end of the channel list. The sort sequence of your channel list remains unchanged; the only change is that the channel data (transmission frequency etc.) are updated
- "Save, do not activate" - the new servicelist will be saved by the receiver and can be selected at the next factory reset. This has no effect on the current servicelist
- "Abort" - the new servicelist will not be loaded





Confirm the desired selection with the  button. The following display appears:

SERVICE MENU



During the update, do not under any circumstances unplug the receiver from the mains. This may corrupt the entire software and necessitate return of the receiver for repair!



Now use the   buttons to select whether you wish to update the software (“Yes”) or abort the procedure (“No”). Confirm the desired selection with the  button.

The following display appears:

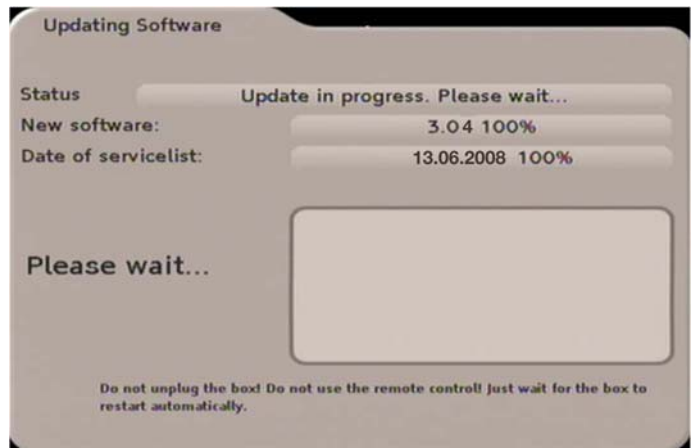

When the download has been completed the receiver will reboot. The software update is now completed.

SERVICE MENU

UPDATE THE SOFTWARE LATER (MANUALLY)

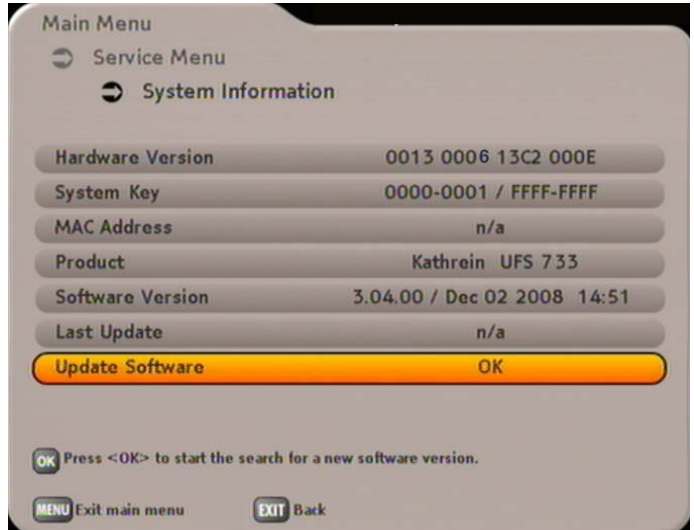

Press the **OK** button to confirm the start of the search or press the **EXIT** button to cancel the action. The following display appears:

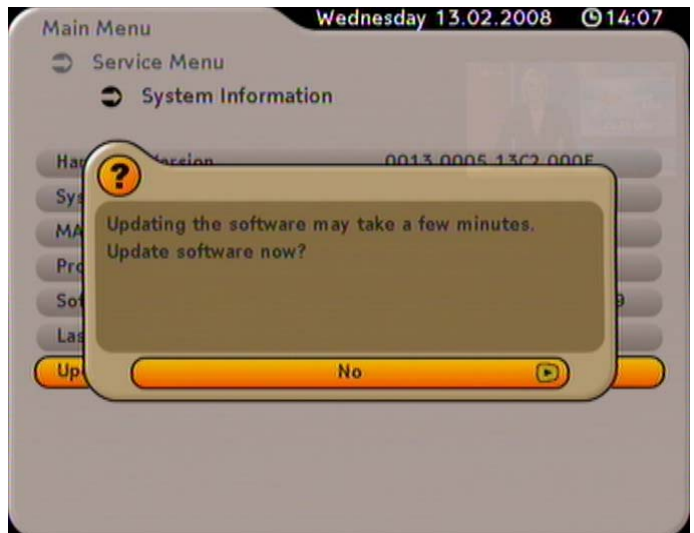

In the following information window, use the **◀▶** buttons to select "Yes" and start the update by pressing the **OK** button.

The receiver will now automatically search for new software. This process can take a few minutes. If no new updates are available, a corresponding message will be displayed and you can return to the TV picture by pressing the **EXIT** button.

If new updates are available, follow the instructions displayed in the menu.

SERVICE MENU



RESTORING FACTORY SETTINGS



Here you can reset all the settings to the pre-programmed factory settings.



All your personal preferences (favourites lists, channel sorting, etc.) will be deleted!

Select "Yes" using the   buttons and confirm the reset by pressing the  button.

LANGUAGE

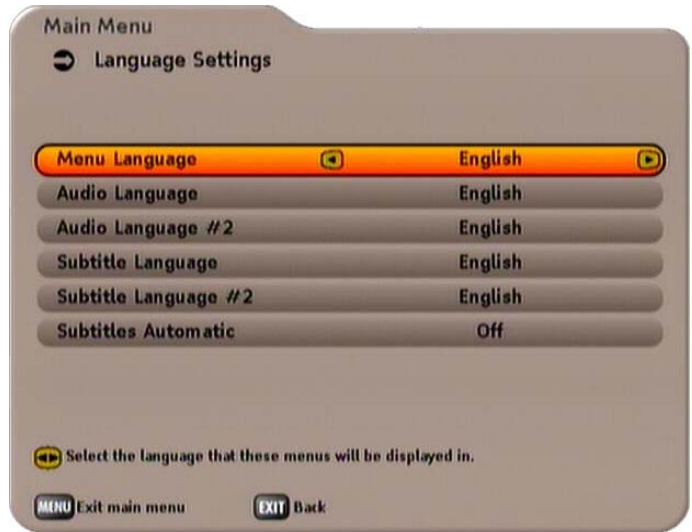

Use the **▲▼** buttons to select the line you want to change. Use the **◀▶** buttons to make the changes.

Menu Language:

Select the required menu language.

Available options: German, English, French, Italian, Spanish, Czech, Dutch and Turkish.

First and second audio language:

Select here the required audio languages. Available options: German, English, French, Italian, Spanish, Czech, Dutch, Turkish, Portuguese, Polish, Swedish, Finnish, Danish, Norwegian, Slovakian, Catalan, Basque, Russian, Greek, Icelandic, Welsh and Gaelic.

First and second subtitle language:

Select here the required subtitle language. Available options: German, English, French, Italian, Spanish, Czech, Dutch, Turkish, Portuguese, Polish, Swedish, Finnish, Danish, Norwegian, Slovakian, Catalan, Basque, Russian, Greek, Icelandic, Welsh and Gaelic.

Subtitles Automatic:

Here you can set whether subtitles are displayed automatically or not.

To quit the menu and save the changes, press the **EXIT** button.

TECHNICAL APPENDIX

TECHNICAL FEATURES

- Reception of digital TV and Radio satellite programmes
- 4,000 channel memory positions
- 16-character alphanumeric display with status icons for indication of channel names and transmitter information
- Conax decoding system embedded
- Common Interface for one CA module ¹⁾
- HDMI output for optimal transmission to a flat-screen TV set
- Up-scaler for upscaling the Pal signal (576i) to 576p, 720p and 1080i
- Kathrein Convenience EPG with timer programming ²⁾
- Guided first installation
- Pre-programmed channel list
- Automatic software download
- Suitable for software download via satellite and PC
- 4 favourite channel lists
- Automatic date and time generation via DVB data stream
- On-screen display (OSD) in 8 languages (D, GB, F, I, E, CZ, TR, NL)
- 8 timers; can also be programmed from the EPG
- Language selection for multilingual broadcasts
- Optical and electrical audio output for Dolby Digital data stream (AC 3)
- Comp. colour, Y/C and RGB signal outputs programmable over Scart socket (TV)
- Cinch sockets for audio L/R signal
- Videotext decoder with 800 page memory capacity and Videotext generation (Scart)
- Channel search
- Programme position sort function
- DiSEqC™1.0 and SCR single-cable control signals
- Infra-red remote control
- Power switch
- An additional IR sensor can be connected

¹⁾ CA module not included with this product

²⁾ Only displayed if this information is broadcast by the channel provider

TECHNICAL APPENDIX

| Type | | UFS 733si | UFS 733sw |
|---|------------------|---|----------------|
| Order no./colour | | 20210131/silver | 20210132/black |
| RF properties sat | | | |
| Input frequency range | MHz | 950-2150 | |
| Input level range | dB μ V | 44-83 | |
| Reception threshold (EB/NO) | dB | < 4.5 | |
| TV system, video | | | |
| Modulation, FEC, demultiplexer | | DVB-S standard | |
| Video resolution | | CCIR 601 (720 x 576 lines), 576i, 576p, 720p, 1080i | |
| Input data rate | M/Symb/s | 2-45 | |
| Video decryption | | MPEG-1 and -2 compatible | |
| Bit rate | MBit/s | 1.5-15 | |
| Frequency range | MHz | 0.02-5 | |
| Output voltage | V _{pp} | 1 | |
| S/N | dB | > 53 | |
| TV system, audio | | | |
| Audio decoding | | MPEG-1 and -2, layer 1 and 2 | |
| Sampling rate | kHz | 32/44.1/48 | |
| Frequency range | kHz | 0.04-20 | |
| Output voltage | mV _{pp} | Type 770 | |
| S/N | dB | > 65 | |
| Memory | | | |
| Flash-RAM/SDRAM | MB | 4/16 | |
| Processor clock speed | MHz | 150 | |
| Power supply | | | |
| Power supply voltage | V/Hz | 230 (\pm 10 %)/50 | |
| Power consumption (power/standby) | W | < 22/< 8 | |
| LNB supply vert./horiz. | V/mA | 14/18/Max. 400 | |
| Control signal | kHz | 22; DiSEqC™1.0; SCR single-cable system | |
| Connections | | | |
| Sat IF input/output | | F socket | |
| TV/VCR output | | 2 x Scart socket | |
| Video/audio output (digital) | | 1 x HDMI | |
| Audio output (analogue) | | 2 x Cinch socket | |
| Audio digital output (electrical/optical) | | Cinch socket/standard fibre-optic (SPDIF) | |
| Data interface | | RJ 11 socket | |
| Common Interface/Encryption system | | 1/Conax integrated | |
| General Information | | | |
| Permissible ambient temperature | °C | +5 to +40 | |
| Unit dimensions/weight | mm/kg | 280 x 45 x 190/< 2 | |

TECHNICAL APPENDIX

SCART SOCKET ASSIGNMENT

| Signal | Pin no. | TV | VCR/AUX |
|-----------------------|---------|----|---------|
| Audio right output | 1 | X | X |
| Audio right input | 2 | | X |
| Audio left output | 3 | X | X |
| Audio earth | 4 | X | X |
| Blue earth | 5 | X | X |
| Audio left input | 6 | | X |
| Blue signal | 7 | X | X |
| Switching voltage | 8 | X | X |
| Green earth | 9 | X | X |
| Data signal | 10 | | |
| Green signal | 11 | X | X |
| Data signal | 12 | | |
| Red earth | 13 | X | X |
| Data earth | 14 | | |
| Red signal (C) | 15 | X | X |
| Blanking signal | 16 | X | X |
| Video earth | 17 | X | X |
| Blanking signal earth | 18 | X | X |
| Video output (FBAS/Y) | 19 | X | X |
| Video input | 20 | | X |
| Connector shield | 21 | X | X |

VHS/S-VHS SWITCHING

The Scart sockets are can be switched between VHS and S-VHS. The changeover is made by selecting "Main Menu", "Box Settings", "TV picture settings".

For VHS (RGB): The red signal is connected to terminal 15, the composite colour output to terminal 19.
For S-VHS (C/Y): The Y output is connected to pin 19, the C output to pin 15.

TECHNICAL APPENDIX

CONNECTION EXAMPLE

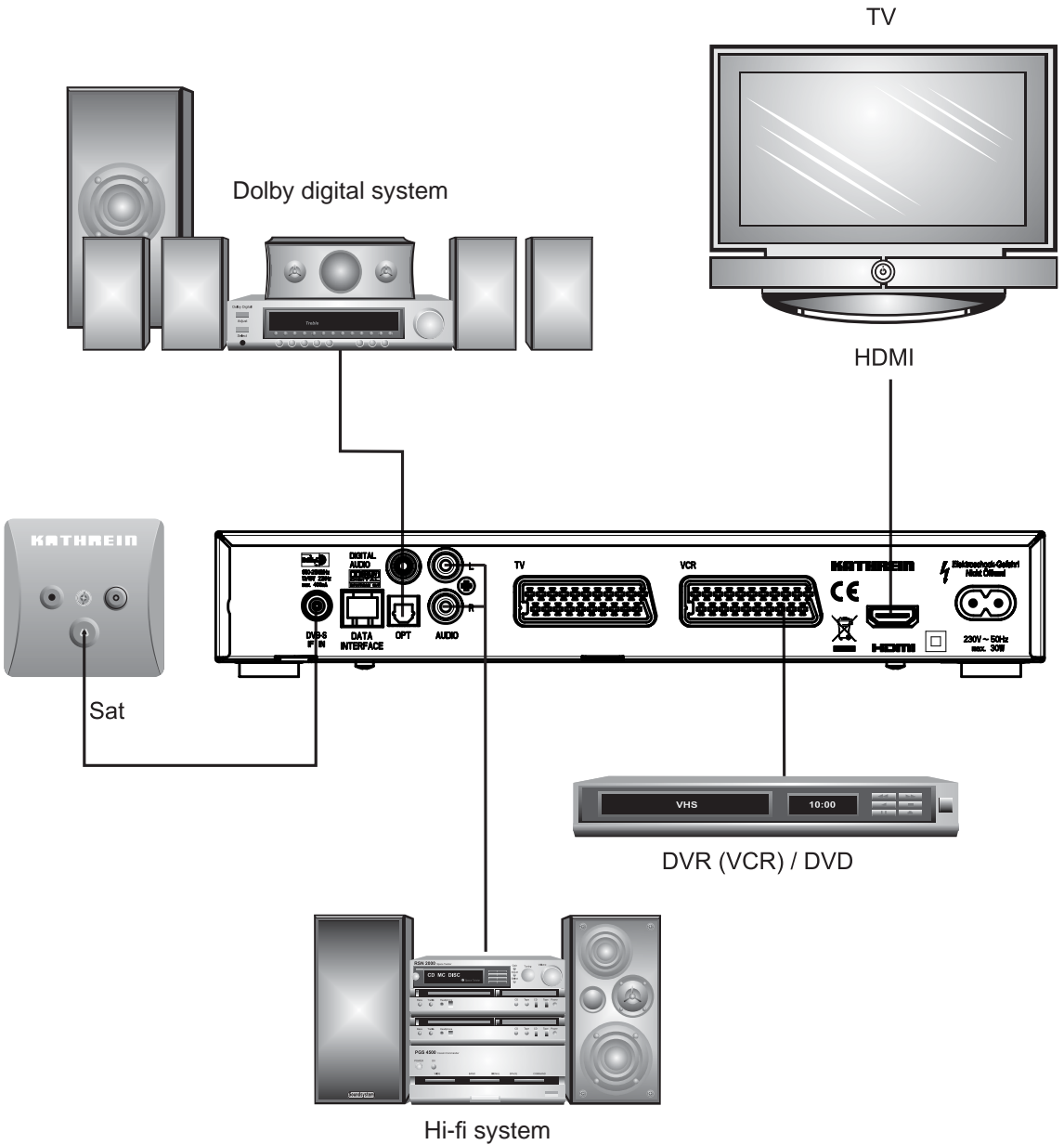

TECHNICAL APPENDIX

EXAMPLES single-cable systems

EXR 501/551/552

Single-cable switching matrices

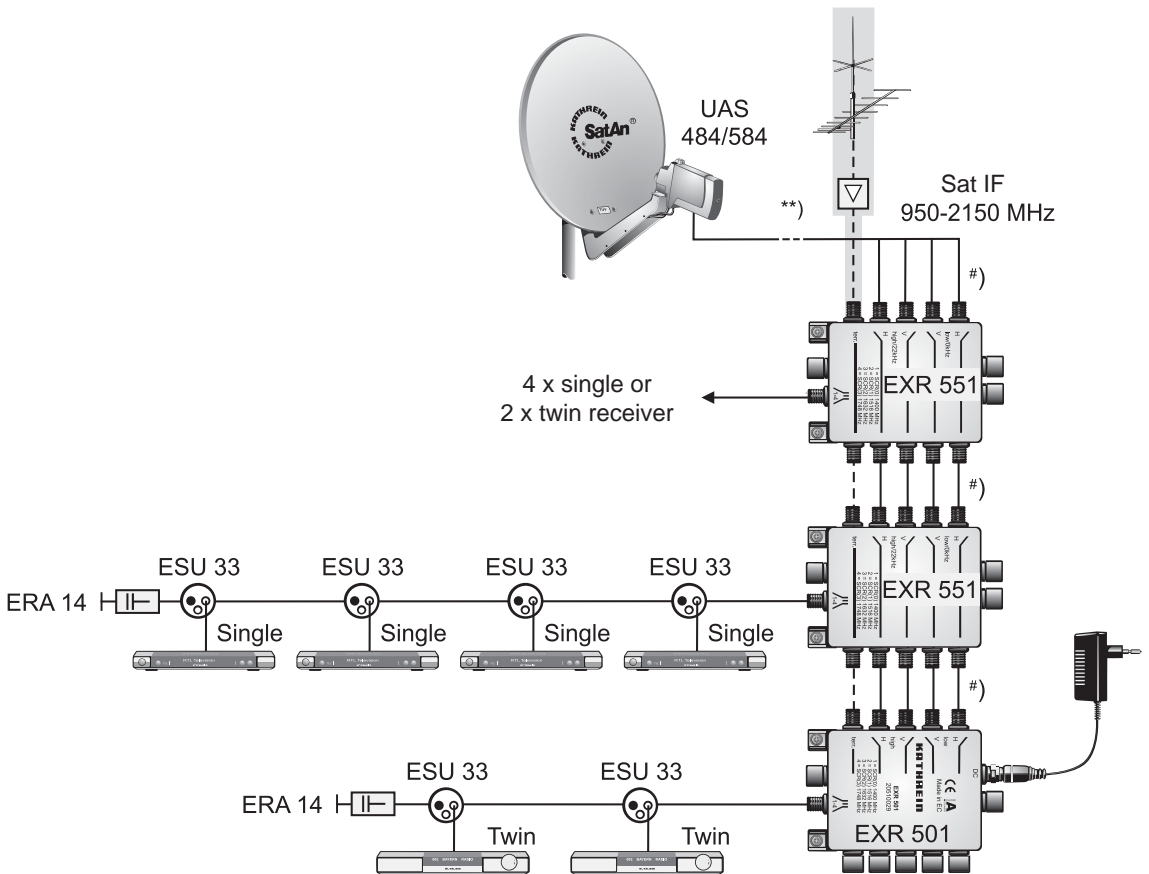

*) The receiver must be programmed for single-cable commands

**) Overvoltage protection KAZ 11/KAZ 12

UAS 481

Single-cable feed system

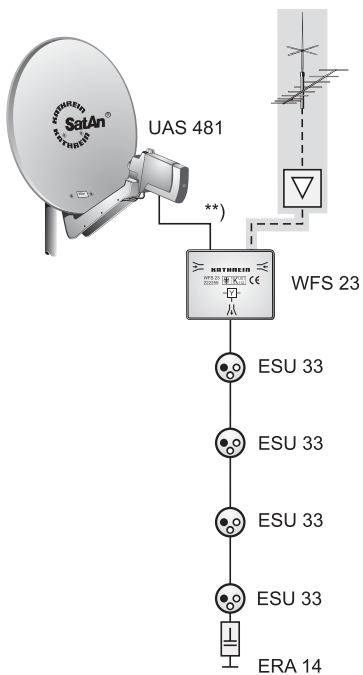
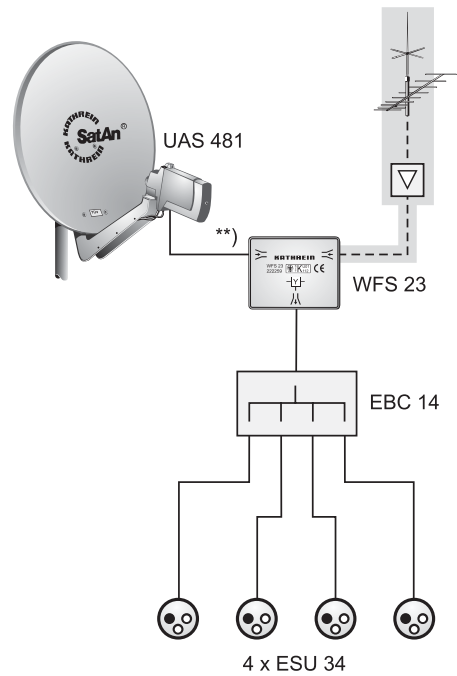
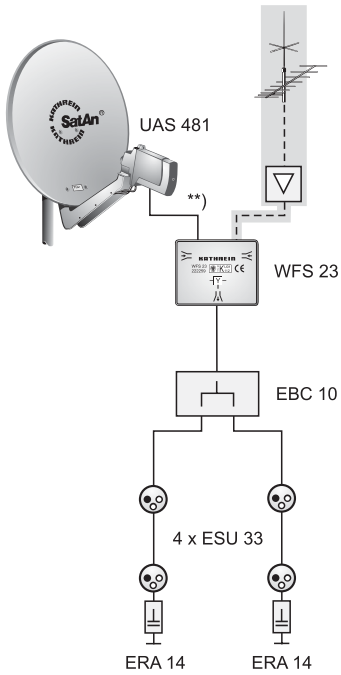

- *) The receiver must be programmed for single-cable commands
- **) Overvoltage protection KAZ 11/KAZ 12

EXU 908

Single cable matrix

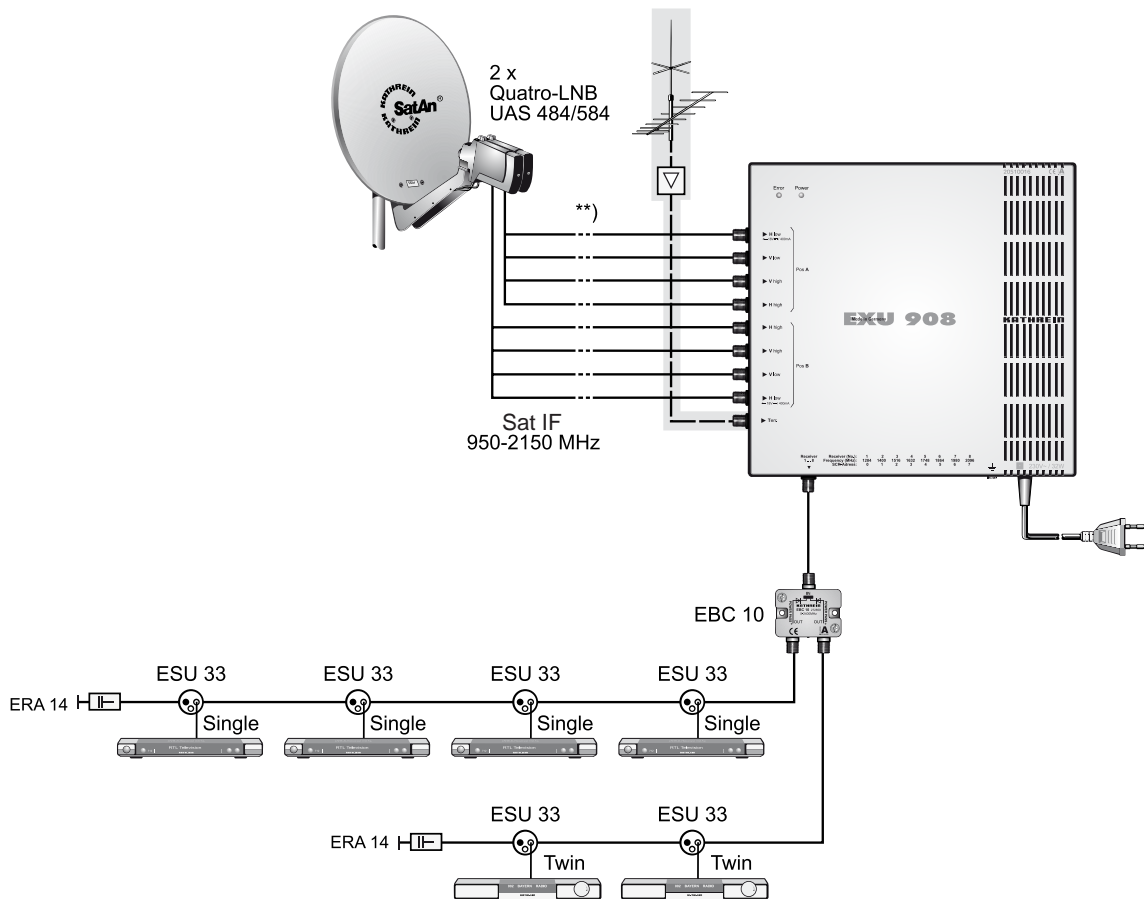

*) The receiver must be programmed for single-cable commands

**) Overvoltage protection KAZ 11/KAZ 12

EXR 1581/2581

Single-cable matrices

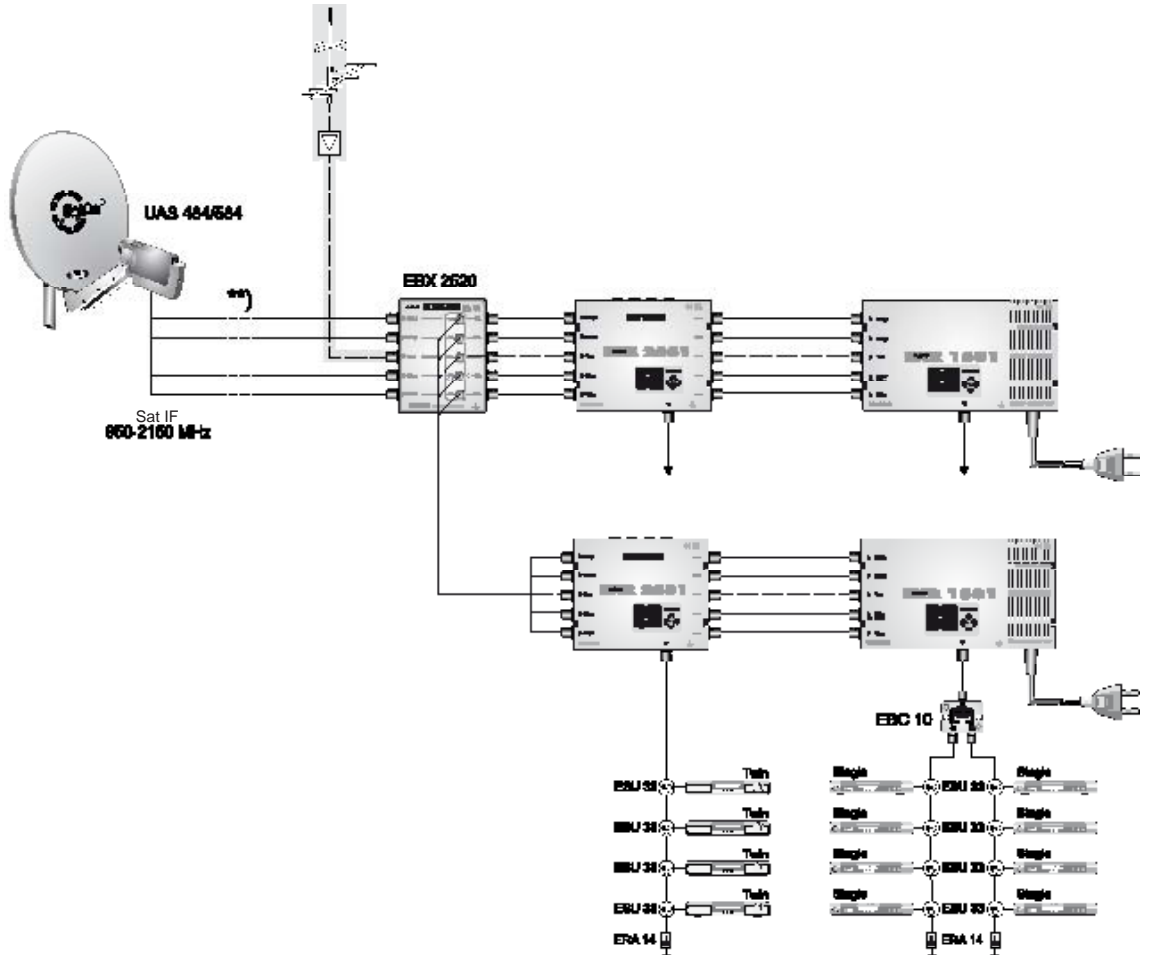

*) The receiver must be programmed for single-cable commands

**) Overvoltage protection KAZ 11/KAZ 12

FOR YOUR NOTES

Internet: <http://www.kathrein.de>

KATHREIN-Werke KG • Anton-Kathrein-Straße 1 - 3
P.O. Box 100 444 • 83004 Rosenheim GERMANY

Download from [Www.Somanuals.com](http://www.Somanuals.com). All Manuals Search And Download.

KATHREIN
Antennen • Electronic

Free Manuals Download Website

<http://myh66.com>

<http://usermanuals.us>

<http://www.somanuals.com>

<http://www.4manuals.cc>

<http://www.manual-lib.com>

<http://www.404manual.com>

<http://www.luxmanual.com>

<http://aubethermostatmanual.com>

Golf course search by state

<http://golfingnear.com>

Email search by domain

<http://emailbydomain.com>

Auto manuals search

<http://auto.somanuals.com>

TV manuals search

<http://tv.somanuals.com>