

KAWAI

DIGITAL PIANO

CN33

Owner's Manual

PART NAMES AND
FUNCTIONS
1

PLAYING THE
PIANO
2

CONCERT MAGIC
3

LESSON
FUNCTION
4

RECORDER
5

USB OPERATIONS
6

FUNCTION
BUTTONS
7

APPENDICES
8

Thank you for purchasing a KAWAI CN33 digital piano!

This instrument combines the latest digital technologies with traditional piano craftsmanship, delivering a truly breathtaking musical experience for amateur and professional pianists alike. The CN33's rich, expressive tone has been created through the meticulous recording of KAWAI's hand-built concert grand pianos, and reproduced using unique *Progressive Harmonic Imaging™* sound technology. While the *Responsive Hammer* action features a realistic weight-graded keyboard with *Ivory Touch* surfaces and authentic *Let-off* mechanism to satisfy the demands of even the most discerning pianist.

The CN33 digital piano also features reverb and digital effects processors that create a richer, more authentic sound, while the Lesson function helps budding performers to practice the piano using a selection of built-in etudes from Czerny and Burgmüller, or songs from the popular Alfred's Basic Piano Library and Alfred's Premier Piano Course lesson books. Finally, standard MIDI and USB-MIDI connectors are provided to allow communication with computers or other electronic instruments, while recorded songs can also be stored on a USB memory device.

This owner's manual contains useful information regarding the varied functions and capabilities of the CN33 digital piano. Please read all sections carefully and keep this documentation handy for future reference.

Table of Contents

◆ Important Safety Instructions	4	5. RECORDER	33
1. PART NAMES AND FUNCTIONS	8	1) RECORDING (REC BUTTON)	33
◇ FRONT PANEL	8	◇ RECORDING A SECOND PART	34
◇ PEDALS	8	2) PLAYING BACK A SONG.....	36
◇ HEADPHONES.....	9	◇ PLAYING BACK RECORDED PARTS SEPARATELY ...	36
2. PLAYING THE PIANO	10	3) ERASING A SONG	37
1) BASIC OPERATIONS.....	10	6. USB OPERATIONS	38
◇ SETTING UP THE PIANO	10	1) USB PLAY	38
2) DEMO SONGS	11	2) USB LOAD	39
3) SELECTING A SOUND	12	3) USB SAVE	40
4) DUAL MODE	13	4) USB DELETE	41
5) SPLIT MODE.....	15	5) USB FORMAT	42
6) FOUR HANDS MODE	17	7. FUNCTION BUTTONS	43
7) REVERB AND EFFECTS.....	19	◇ ENTERING A FUNCTION MODE.....	43
◇ ADDING REVERB	19	◇ EXITING A FUNCTION MODE	43
◇ APPLYING EFFECTS	20	1) LOWER OCTAVE SHIFT	44
8) TRANSPOSE.....	21	2) LOWER PEDAL ON/OFF	45
9) METRONOME	22	3) DAMPER HOLD ON/OFF.....	46
◇ STARTING THE METRONOME.....	22	4) DAMPER EFFECT	47
◇ CHANGING THE METRONOME TIME SIGNATURE ...	22	5) STRING RESONANCE	48
◇ ADJUSTING THE METRONOME VOLUME	23	6) TOUCH CURVE.....	49
10) PANEL LOCK	24	7) FOUR HANDS ON/OFF	50
3. CONCERT MAGIC	25	8) TUNING	51
◇ SELECTING A SONG	25	9) TEMPERAMENT	52
◇ LISTENING TO THE SONG	25	◇ KEY SIGNATURE OF TEMPERAMENT	53
◇ PERFORMING A SONG	26	◇ MIDI OVERVIEW	54
◇ CONCERT MAGIC PART VOLUME BALANCE	26	◇ CN33 MIDI functions.....	54
◇ CONCERT MAGIC SONG ARRANGEMENT TYPES ...	27	10) MIDI CHANNEL.....	55
◇ STEADY BEAT	28	11) TRANSMIT PROGRAM CHANGE ON/OFF	56
◇ CONCERT MAGIC DEMO MODES.....	28	12) LOCAL CONTROL ON/OFF.....	58
◇ CONCERT MAGIC PLAYBACK SPEED	29	13) MULTI-TIMBRAL MODE ON/OFF	59
4. LESSON FUNCTION.....	30	14) CHANNEL MUTE	60
1) SELECTING A BOOK/SONG	30	15) SENDING PROGRAM CHANGE NUMBERS	61
2) LISTENING TO AND PLAYING A SONG	31	16) USER MEMORY.....	62
◇ EXITING THE LESSON FUNCTION	31	17) FACTORY RESET	63
◇ PRACTICING THE LEFT AND RIGHT-HAND PARTS ...	31	8. APPENDICES.....	64
◇ ADJUSTING THE TEMPO OF A SONG	31	◇ CONNECTING TO OTHER DEVICES.....	64
3) RECORDING A SONG PRACTICE	32	◇ ASSEMBLY INSTRUCTIONS	66
◇ PLAYING BACK THE RECORDING	32	◇ SPECIFICATIONS	68
◇ ERASING THE RECORDING.....	32	◇ MIDI EXCLUSIVE DATA FORMAT	69
		◇ MIDI IMPLEMENTATION CHART	70

Important Safety Instructions

SAVE THESE INSTRUCTIONS

INSTRUCTIONS PERTAINING TO A RISK OF FIRE, ELECTRIC SHOCK, OR INJURY TO PERSONS



WARNING

TO REDUCE THE RISK OF FIRE OR ELECTRIC SHOCK, DO NOT EXPOSE THIS PRODUCT TO RAIN OR MOISTURE.

AVIS : RISQUE DE CHOC ELECTRIQUE - NE PAS OUVRIR.

TO REDUCE THE RISK OF ELECTRIC SHOCK, DO NOT REMOVE COVER (OR BACK). NO USER-SERVICEABLE PARTS INSIDE. REFER SERVICING TO QUALIFIED SERVICE PERSONNEL.



The lightning flash with arrowhead symbol, within an equilateral triangle, is intended to alert the user to the presence of uninsulated "dangerous voltage" within the product's enclosure that may be of sufficient magnitude to constitute a risk of electric shock to persons.



The exclamation point within an equilateral triangle is intended to alert the user to the presence of important operating and maintenance (servicing) instructions in the literature accompanying the product.

Examples of Picture Symbols



denotes that care should be taken.
The example instructs the user to take care not to allow fingers to be trapped.



denotes a prohibited operation.
The example instructs that disassembly of the product is prohibited.



denotes an operation that should be carried out.
The example instructs the user to remove the power cord plug from the AC outlet.

Read all the instructions before using the product.

- 1) Read these instructions.
- 2) Keep these instructions.
- 3) Heed all warnings.
- 4) Follow all instructions.
- 5) Do not use this apparatus near water.
- 6) Clean only with dry cloth.
- 7) Do not block any ventilation openings. Install in accordance with the manufacturer's instructions.
- 8) Do not install near any heat sources such as radiators, heat registers, stoves, or other apparatus (including amplifiers) that produce heat.
- 9) Do not defeat the safety purpose of the polarized or grounding-type plug. A polarized plug has two blades with one wider than the other. A grounding type plug has two blades and a third grounding prong. The wide blade or the third prongs are provided for your safety. If the provided plug does not fit into your outlet, consult an electrician for replacement of the obsolete outlet.
- 10) Protect the power cord from being walked on or pinched particularly at plugs, convenience receptacles, and the point where they exit from the apparatus.
- 11) Only use attachments/accessories specified by the manufacturer.
- 12) Use only with the cart, stand, tripod, bracket, or table specified by the manufacturer, or sold with the apparatus. When a cart is used, use caution when moving the cart/apparatus combination to avoid injury from tip-over. 
- 13) Unplug this apparatus during lightning storms or when unused for long periods of time.
- 14) Refer all servicing to qualified service personnel. Servicing is required when the apparatus has been damaged in any way, such as power-supply cord or plug is damaged, liquid has been spilled or object have fallen into the apparatus, the apparatus has been exposed to rain or moisture, does not operate normally, or has been dropped.

WARNING - When using electric products, basic precautions should always be followed, including the following.



WARNING

Indicates a potential hazard that could result in death or serious injury if the product is handled incorrectly.

The product should be connected to an AC outlet of the specified voltage.

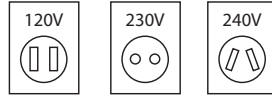

- If you are going to use an AC power cord, make sure that its has the correct plug shape and conforms to the specified power voltage.
- Failure to do so may result in fire.

Do not insert or disconnect the power cord plug with wet hands.



Doing so may cause electric shock.

Take care not to allow any foreign matter to enter the product.

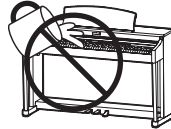

Entry of water, needles or hair pins may result in breakdown or short-circuit. The product shall not be exposed to dripping or splashing. No objects filled with liquids, such as vases, shall be placed on the product.

The chair must be used properly (it must be used only when playing the product).

- Do not play with it or stand on it.
- Only one person is allowed to sit on it.
- Do not sit on it when opening the lid.
- Re-tighten the bolts occasionally.

Doing so may cause the chair to fall over or your fingers to be trapped, resulting in injury.

When using the headphones, do not listen for long periods of time at high volume levels.

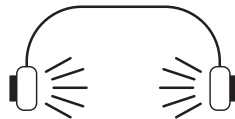

Doing so may result in hearing problems.

Do not lean against the keyboard.

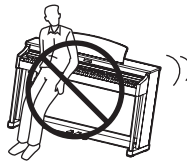

Doing so may cause the product to fall over, resulting in injury.

Do not disassemble, repair or modify the product.

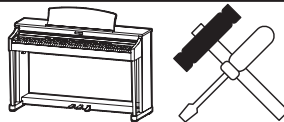

Doing so may result in product breakdown, electric shock or short-circuit.

When disconnecting the AC power cord's plug, always hold the plug and pull it to remove it.



- Pulling the AC power cord itself may damage the cord, causing a fire, electric shock or short-circuit.

The product is not completely disconnected from the power supply even when the power switch is turned off. If the product will not be used for a long time, unplug the AC power cord from the AC outlet.



- Failure to do so may cause fire in case of lightning.
- Failure to do so may over-heat the product, resulting in fire.

This product may be equipped with a polarized line plug (one blade wider than the other). This is a safety feature. If you are unable to insert the plug into the outlet, contact an electrician to replace your obsolete outlet. Do not defeat the safety purpose of the plug.

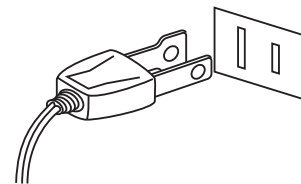

It is a good practice to have the instrument near the AC outlet and the power cord plug in a position so that it can readily be disconnected in an emergency because electricity is always charging while the plug is in the AC outlet even in a power switch off condition.



CAUTION

Indicates a potential hazard that could result in injury or damage to the product or other property if the product is handled incorrectly.

Do not use the product in the following areas.

- Areas, such as those near windows, where the product is exposed to direct sunlight
- Extremely hot areas, such as near a heater
- Extremely cold areas, such as outside
- Extremely humid areas
- Areas where a large amount of sand or dust is present
- Areas where the product is exposed to excessive vibrations

Using the product in such areas may result in product breakdown. Use the product only in moderate climates (not in tropical climates).

When you close the keyboard cover, close it gently.



Closing it roughly may trap your fingers, resulting in injury.

Before connecting cords, make sure that the power to this product and other devices is turned OFF.

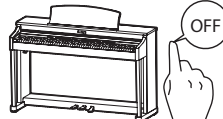

Failure to do so may cause breakdown of this product and other devices.

Do not drag the product on the floor. Take care not to drop the product.

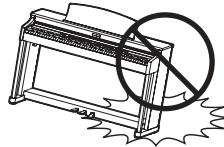

Please lift up the product when moving it. Please note that the product is heavy and must be carried by more than two persons. Dropping the product may result in breakdown.

Do not place the product near electrical appliances such as TVs and radios.

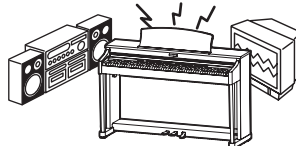

- Doing so may cause the product to generate noise.
- If the product generates noise, move the product sufficiently away from the electrical appliance or connect it to another AC outlet.

When connecting the AC power cord and other cords, take care not to get them tangled.



Failure to do so may damage them, resulting in fire, electric shock or short-circuit.

Do not wipe the product with benzene or thinner.



- Doing so may result in discoloration or deformation of the product.
- When cleaning the product, put a soft cloth in lukewarm water, squeeze it well, then wipe the product.

Do not stand on the product or exert excessive force.



- Doing so may cause the product to become deformed or fall over, resulting in breakdown or injury.

Do not place naked flame, such as lighted candles on the product.

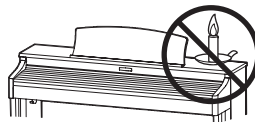

Doing so may cause the illumination to fall over, resulting in fire.

Ensure that the ventilation is not impeded by covering the ventilation openings with items, such as newspaper, table-cloths, curtains, etc.

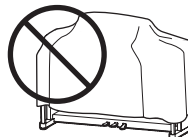

Failure to do so may over-heat the product, resulting in fire.

The product should be located so that its location or position does not interfere with its proper ventilation. Ensure a minimum distance of 5cm around the product for sufficient ventilation.

The product should be serviced by qualified service personnel when:

- The power supply cord or the plug has been damaged.
- Objects have fallen, or liquid has been spilled into the product.
- The product has been exposed to rain.
- The product does not appear to operate normally or exhibits a marked change in performance.
- The product has been dropped, or the enclosure damaged.

Notes on Repair

Should an abnormality occur in the product, immediately turn the power OFF, disconnect the power cord plug, and then contact the shop from which the product was purchased.

CAUTION:

To prevent electric shock, match wide blade of plug to wide slot, fully insert.

ATTENTION:

Pour éviter les chocs électriques, introduire la lame la plus large de la fiche dans la borne correspondante de la prise et pousser jusqu'au fond.

Instruction for AC power cord (U.K.)

Do not plug either terminal of the power cord to the ground of the AC outlet on the wall.

Canadian Radio Interference Regulations

This instrument complies with the limits for a class B digital apparatus, pursuant to the Radio Interference Regulations, C.R.C., c. 1374.

**An information on Disposal for users**

If your product is marked with this recycling symbol it means that, at the end of its life, you must dispose of it separately by taking it to an appropriate collection point.

You should not mix it with general household waste. Disposing of this product correctly will prevent potential negative effects on the environment and human health which could otherwise arise due to inappropriate waste handling.

For further details, please contact your local authority.
(European Union only)

FCC Information (U.S.A)

CAUTION : Changes or modifications not expressly approved by the party responsible for compliance could void the user's authority to operate the equipment.

NOTE : This equipment has been tested and found to comply with the limits for a Class B digital device, pursuant to Part 15 of the FCC Rules. These limits are designed to provide reasonable protection against harmful interference in a residential installation. This equipment generates, uses and can radiate radio frequency energy and, if not installed and used in accordance with the instructions, may cause harmful interference to radio communications. However, there is no guarantee that interference will not occur in a particular installation. If this equipment does cause harmful interference to radio or television reception, which can be determined by turning the equipment off and on, the user is encouraged to try to correct the interference by one or more of the following measures:

- Reorient or relocate the receiving antenna.
- Increase the separation between the equipment and receiver.
- Connect the equipment into an outlet on a circuit different from that to which the receiver is connected.
- Consult the dealer or an experienced radio/TV technician for help.

**Declaration of Conformity**

Products :	Electronic Piano
Model Number :	CN33
Responsible Party Name :	Kawai America Corporation
Address :	2055 East University Drive Rancho Dominguez, CA 90220
Telephone	310-631-1771

This device complies with Part 15 of the FCC Rules. Operation is subject to the following two conditions:

- (1) this device may not cause harmful interference, and
- (2) this device must accept any interference received, including interference that may cause undesired operation.

This applies only to products distributed by Kawai America Corporation.

1. PART NAMES AND FUNCTIONS

This section explains the locations and functions of the panel buttons and sliders.

◇ FRONT PANEL

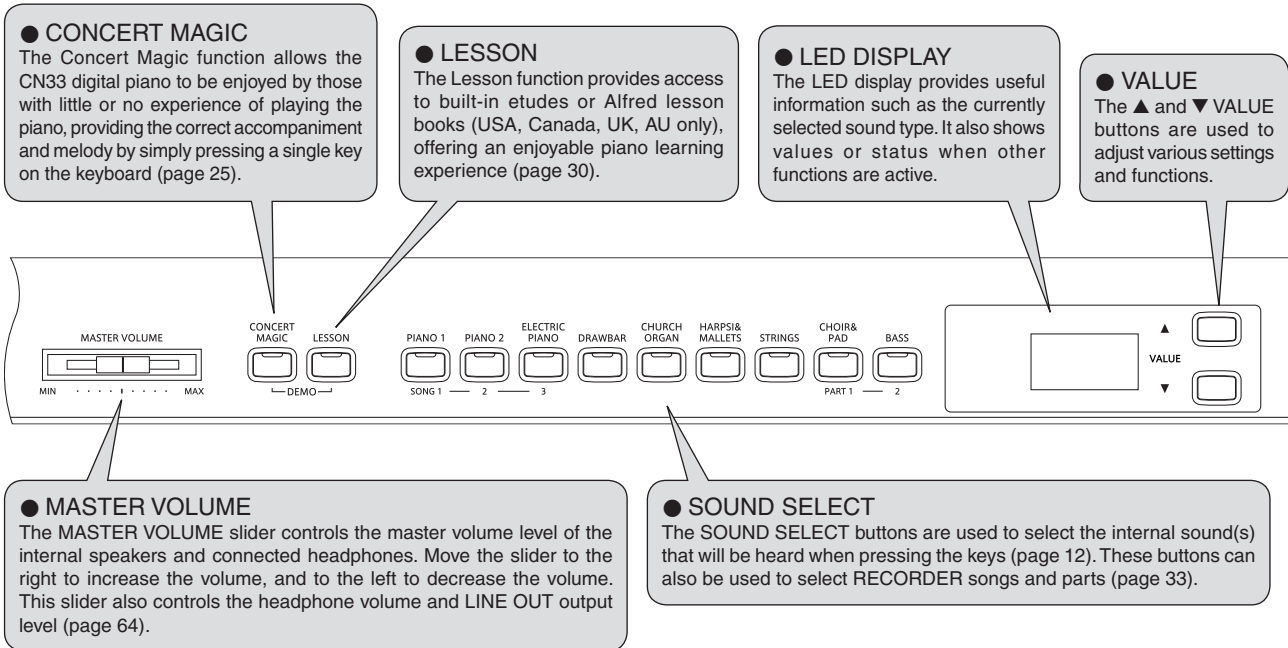

◇ PEDALS

The CN33 piano has three pedals: Damper/Sustain, Sostenuto, and Soft.

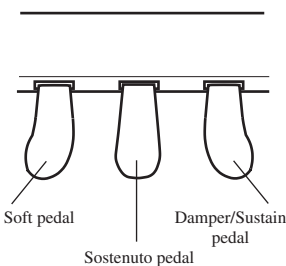

◆ Damper/Sustain pedal

Sustains the sound after hands are lifted from the keyboard. The sustain pedal is capable of responding to half pedaling.

◆ Sostenuto pedal

Depressing this pedal after playing the keyboard and before releasing the keys sustains the sound of only the keys just played. Any keys that are pressed after the Sostenuto pedal is depressed will not be sustained after the keys are released.

◆ Soft pedal

Depressing this pedal softens the sound and reduces its volume. When the rotary effect is active the soft pedal is used to change the speed of the rotor between slow and fast.

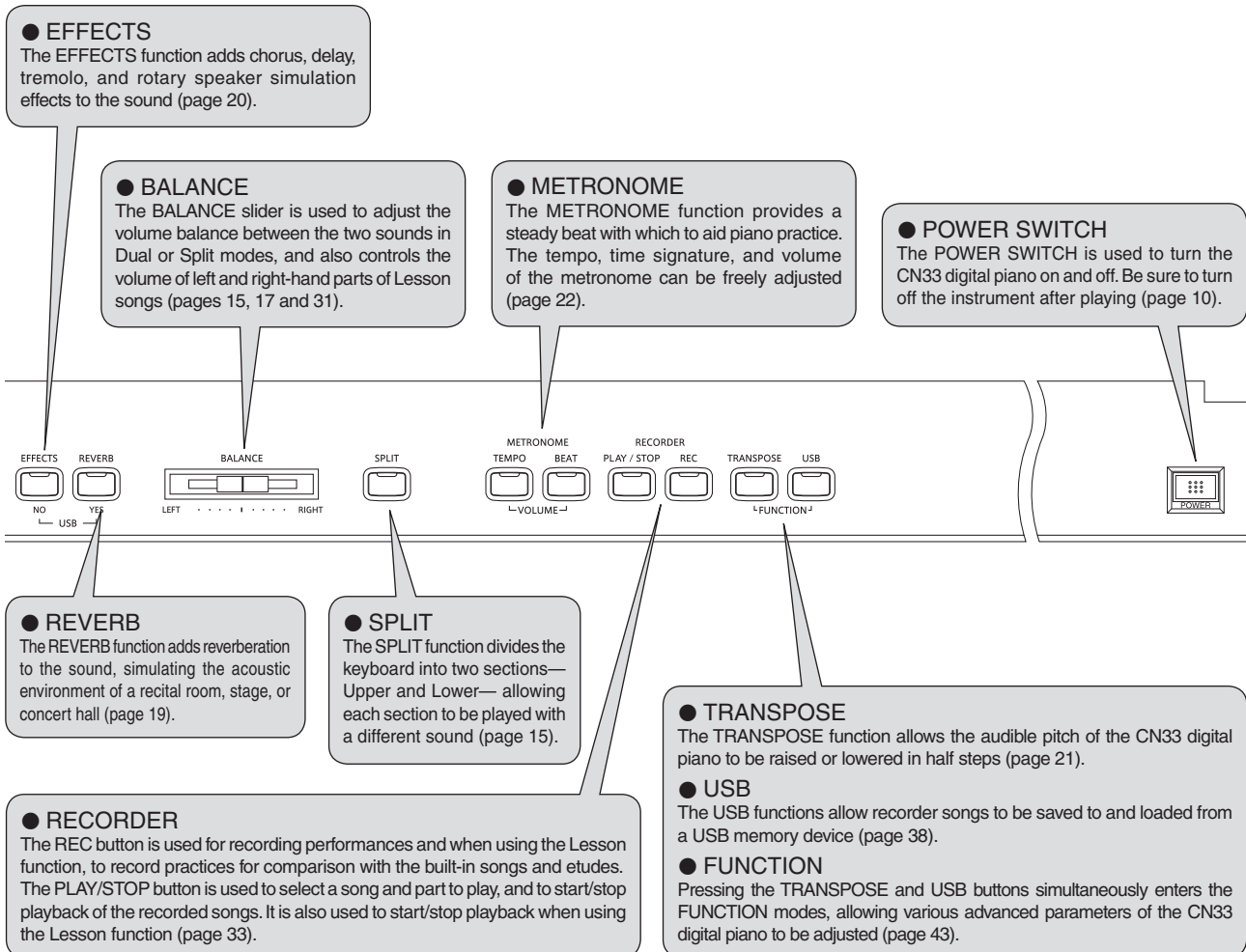

◆ HEADPHONES AND USB CONNECTORS

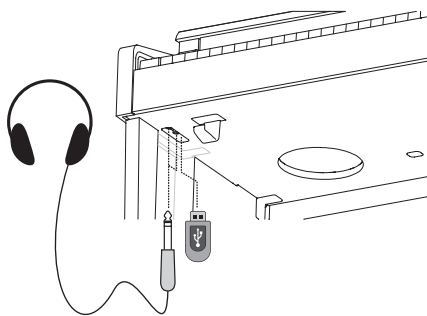

◆ Headphone jack (x 2)

There are two headphone jacks located on the left underside of the piano.

Up to two pairs of headphones can be connected simultaneously.

■ For information on attaching the headphone hook, please refer to the assembly instructions on page 66.

◆ USB (to device)

The USB (to Device) connector is located beside the two headphone jacks, and used to load and save recorder songs to a USB memory device (page 38).

2. PLAYING THE PIANO

1) BASIC OPERATIONS

This section provides the basic procedures for turning the power on and playing the CN33 digital piano.

◇ SETTING UP THE PIANO

The CN33 digital piano is equipped with stereo speakers and an internal amplifier—no addition equipment is required to begin playing the instrument, provided AC power is available.

□ Step 1

Connect one end of the AC power cable to the CN33 digital piano's power jack and the other end of the cable to a wall AC outlet.

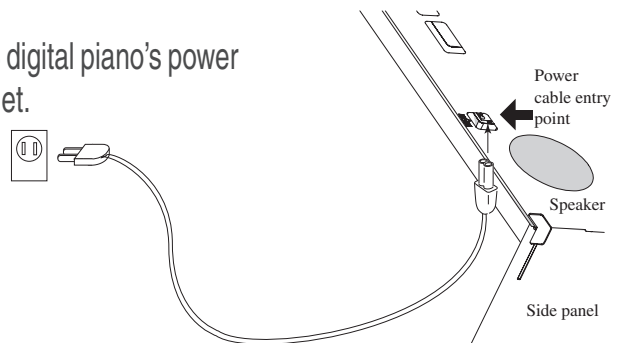

□ Step 2

Press the POWER SWITCH to turn on the power.



The POWER SWITCH is located at the right end of the keyboard.

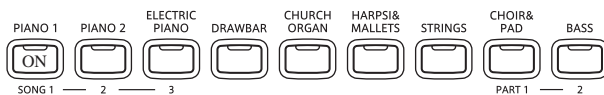

The LED indicator for the PIANO 1 button will turn on, and the Concert Grand sound will be selected automatically.

□ Step 3

Adjust the volume level using the MASTER VOLUME slider.

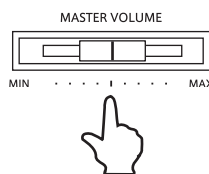

The MASTER VOLUME slider controls the volume level of the speakers and connected headphones.

Move this slider to the right to increase the volume and move it to the left to decrease the volume.

Set the volume to a comfortable listening level—the middle is often a good starting point.

□ Step 4

Play the piano.

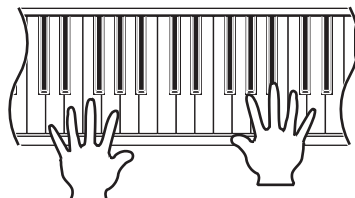

The sound of a Concert Grand piano will be heard as the keys are pressed.

2) DEMO SONGS

The internal demonstration songs provide an excellent introduction to the varied capabilities of the CN33 digital piano, presenting the instrument's rich selection of voices. There are 30 built-in demo songs, each presenting a musical piece to introduce the different internal sounds.

PIANO 1 Concert Grand : KAWAI Studio Grand : KAWAI Mellow Grand : Sonata No.30 Op.109 / Beethoven Modern Piano : KAWAI		HARPSI & MALLETS Harpsichord : French Suite No.6 / Bach Vibraphone : KAWAI Clavi : KAWAI	
PIANO 2 Concert Grand 2 : Waltz No.6 Op.64-1 "Petit chien" / Chopin Studio Grand 2 : KAWAI Mellow Grand 2 : La Fille aux Cheveux de lin / Debussy Rock Piano : KAWAI		STRINGS Slow Strings : KAWAI String Pad : KAWAI String Ensemble : Le quattro stagioni La primavera / Vivaldi	
ELECTRIC PIANO Classic E.Piano : KAWAI Modern E.P. : KAWAI Modern E.P. 2 : KAWAI		CHOIR & PAD Choir : Danny Boy / Irish folk song Choir 2 : KAWAI New Age Pad : KAWAI Atmosphere : KAWAI	
DRAWBER Jazz Organ : KAWAI Drawbar Organ : KAWAI Drawbar Organ 2 : KAWAI		BASS Wood Bass : KAWAI Fretless Bass : KAWAI W. Bass & Ride : KAWAI	
CHURCH ORGAN Church Organ : Chorale Prelude "Wachet auf, ruft uns die Simme." / Bach Diapason : Wohl mir, daß ich Jesum habe / Bach Full Ensemble : KAWAI			

KAWAI regret that sheet music for KAWAI original demo songs is not available.

□ Step 1

Press the **CONCERT MAGIC** and **LESSON** buttons simultaneously.

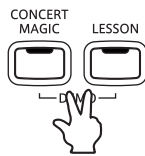

The LED indicators for the **CONCERT MAGIC** and **LESSON** buttons will turn on, and the **SOUND SELECT** buttons will start to flash.

The Concert Grand demo song will start to play.

After the **PIANO 1** demo songs have finished playing, the demo songs from another sound category will be selected at random.

□ Step 2

While the Concert Grand demo song is playing, press the **CHURCH ORGAN** button.

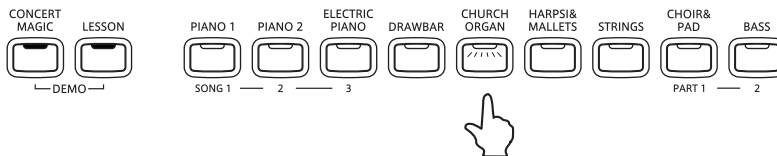

The Church Organ demo song will begin to play.

After the **CHURCH ORGAN** demo songs have finished playing, the demo songs from another sound category will be selected at random.

□ Step 3

Press the **CONCERT MAGIC**, **LESSON**, or **PLAY/STOP** buttons to exit the demo mode.

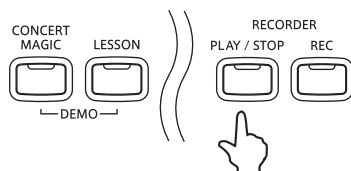

The LED indicators for the **CONCERT MAGIC** and **LESSON** buttons will turn off, the **SOUND SELECT** buttons will stop flashing, and the demo songs will stop playing.

3) SELECTING A SOUND

The CN33 digital piano features 36 realistic sounds suitable for various musical styles, with multiple sounds assigned to each of the 9 category buttons listed below.

Button	Instrument name
PIANO 1	Concert Grand
	Studio Grand
	Mellow Grand
	Modern Piano
PIANO 2	Concert Grand 2
	Studio Grand 2
	Mellow Grand 2
	Rock Piano
ELECTRIC PIANO	Classic E.Piano
	Modern E.P.
	60's E.P.
	Modern E.P. 2
DRAWBAR	Jazz Organ
	Drawbar Organ
	Drawbar Organ 2
	Be 3
CHURCH ORGAN	Church Organ
	Diapason
	Full Ensemble
	Diapason Oct

Button	Instrument name
HARPSI & MALLETS	Harpichord
	Harpichord 2
	Vibraphone
	Clavi
STRINGS	Slow Strings
	String Pad
	Warm Strings
	String Ensemble
CHOIR & PAD	Choir
	Choir 2
	New Age Pad
	Atmosphere
BASS	Wood Bass
	Finger Bass
	Fretless Bass
	W. Bass & Ride

- Step 1
Press the ELECTRIC PIANO button.

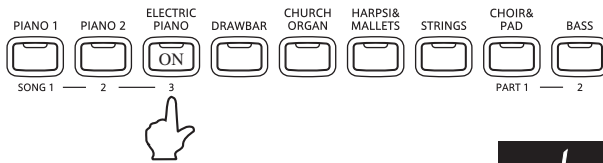

The LED indicator for the ELECTRIC PIANO button will turn on.



The variation number '1' will be shown in the LED display, indicating that the Classic E.Piano sound has been selected.

Several sounds are assigned to each SOUND SELECT button. Press the same SOUND SELECT button multiple times to cycle through each sound variation.

- Step 2
Play the piano.

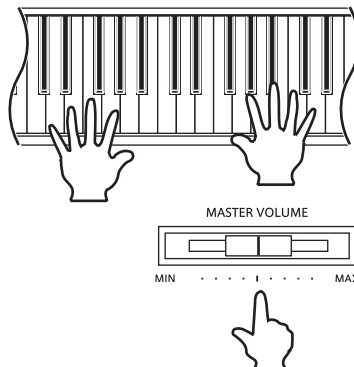

The sound of Classic E.Piano will be heard as the keys are pressed.

Use the MASTER VOLUME slider to adjust the volume, if necessary.

- Step 3
Select other sounds.

Internal sounds can also be selected by pressing the ▲ or ▼ VALUE buttons.

4) DUAL MODE

The DUAL function allows two internal sounds to be layered together, creating a more complex sound. For example, a piano can be layered with strings, or a church organ with a choir sound.

□ Step 1

Press and hold the PIANO1 button, then press the STRINGS button.

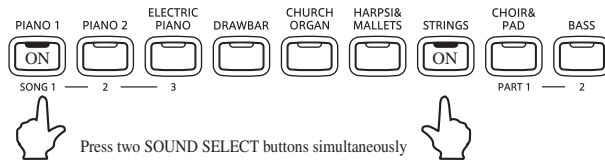

The LED indicators for the PIANO1 and STRINGS buttons will turn on, indicating that both sounds have been selected simultaneously, and DUAL mode has been activated.

The selected sound variation numbers will be shown in the LED display.

The left number represents the primary sound, while the right number represents the secondary sound.

1-1

□ Step 2

Play the piano.

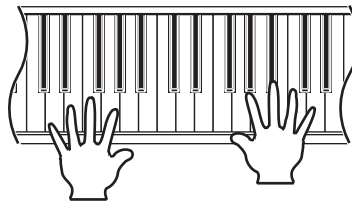

The Concert Grand and Slow Strings sounds will be heard Simultaneously.

□ Step 3

Press and hold the STRINGS button, then press the PIANO1 button.

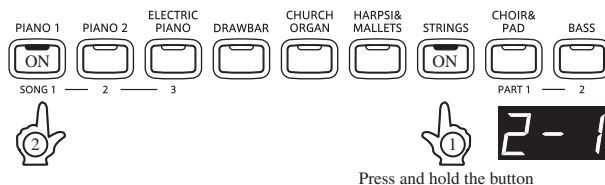

'2-1' will be shown in the LED display, indicating that the primary sound has changed to Studio Grand.

2-1

□ Step 4

Press and hold the PIANO1 button, then press the CHURCH ORGAN button three times.

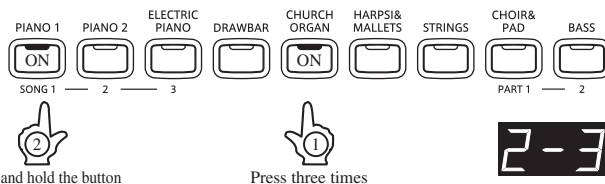

The LED indicators for the PIANO1 and CHURCH ORGAN buttons will turn on.

'2-3' will be shown in the LED display, indicating that the secondary sound has been changed to Full Ensemble.

2-3

To combine two sounds assigned to the same SOUND SELECT button, first select the primary sound, next press and hold the SOUND SELECT button, then press the ▲ or ▼ VALUE buttons to select the desired secondary sound.

□ Step 5

Use the BALANCE slider to adjust the volume balance between the two sounds.

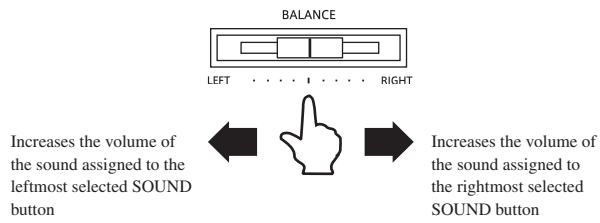

□ Step 6

Press any individual SOUND SELECT button to deactivate DUAL mode.

5) SPLIT MODE

The SPLIT function divides the keyboard of the CN33 digital piano into Upper and Lower sections, allowing each section to be played with a different sound.

- **Step 1**
Press the SPLIT button.

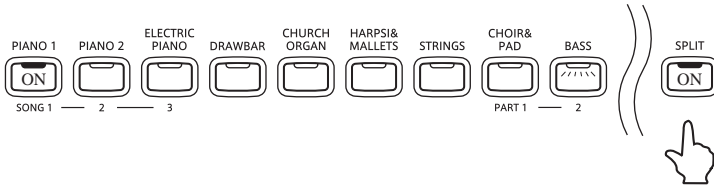

The LED indicator for the SPLIT button will turn on, indicating that SPLIT mode has been activated. In addition, the LED indicator for the PIANO1 button will also turn on, indicating the Upper section sound, while the BASS button will start to flash, indicating the Lower section.

The selected sound variation numbers will be shown in the LED display.



The left number represents the Lower section, while the right number represents the Upper section.

- **Step 2**
Play the piano.

The Concert Grand sound will be heard in the Upper section, while the Wood Bass sound will be heard in the Lower section. An ensemble performance can be enjoyed by playing the chords and the melody with the right hand, while playing a bass line with the left hand.

The number of keys used for the Upper and Lower sections can be freely adjusted by changing the Split Point.

- The default Split Point setting is set between B2 and C3.

- **Step 3**
Press and hold the SPLIT button, then press a key on the keyboard.

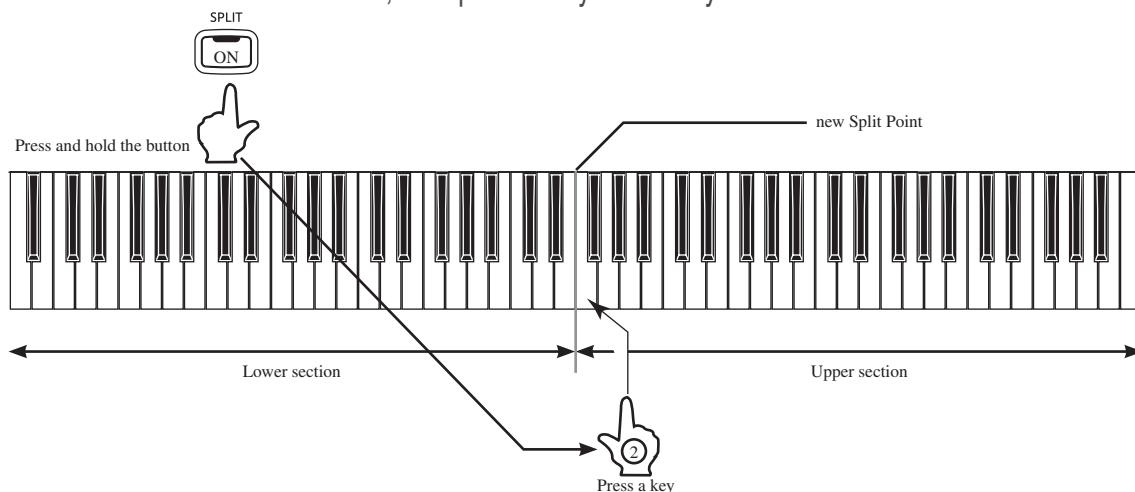

The name of the pressed key will be shown in the LED display, and will become the new Split Point.

□ Step 4

Press the PIANO2 button three times.

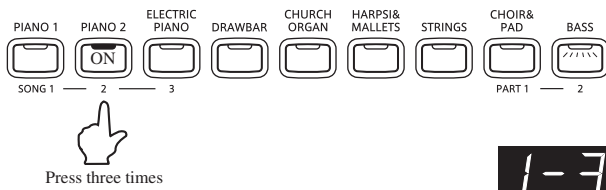

The LED indicator for the PIANO2 button will turn on.

'1-3' will be shown in the LED display, indicating that the Upper section sound has been changed to Mellow Grand 2.

□ Step 5

Press and hold the SPLIT button, then press the HARPSI & MALLETS button twice.

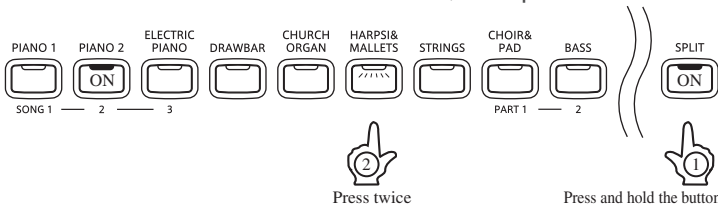

The LED indicator for the HARPSI & MALLETS button will start to flash.

'2-3' will be shown in the LED display, indicating that the Lower section sound has been changed to Vibraphone.

□ Step 6

Use the BALANCE slider to adjust the volume balance between the upper and lower sections.

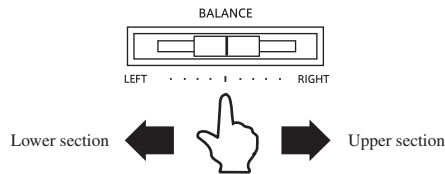

□ Step 7

Press the SPLIT button to deactivate split mode.



The LED indicator for the SPLIT button will turn off.

- When SPLIT mode is activated, the Lower Octave Shift function can be used to adjust the octave range for the Lower section. Please refer to the instructions on page 44 for more information.
- The influence of the damper/sustain pedal over the Lower section can also be turned on and off. Please refer to the instructions on page 45 for more information.

6) FOUR HANDS MODE

The FOUR HANDS function divides the keyboard of the CN33 digital piano into separate Upper and Lower sections in a similar way to that of the SPLIT function. In addition, the octave/pitch of each section is also adjusted, allowing two people to play the piano together.

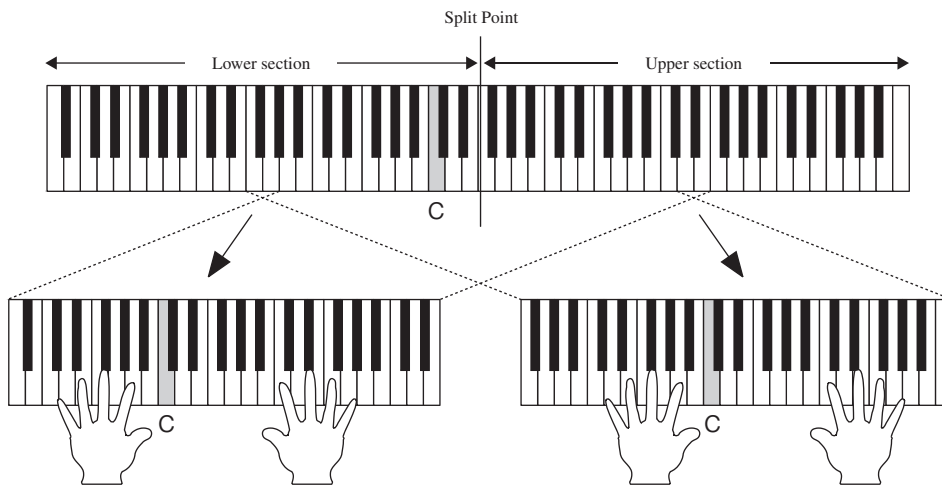

□ Step 1

Press and hold the SPLIT button, then press the damper/sustain (right) pedal and the soft (left) pedal together.

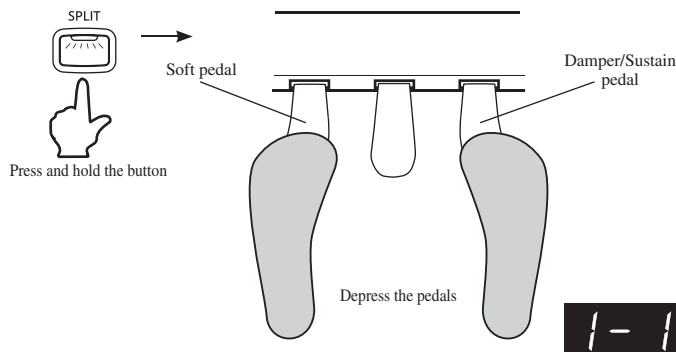

The LED indicator for the SPLIT button will start to flash, indicating that FOUR HANDS mode has been activated.

In addition, the LED indicator for the Upper section sound button will also turn on, while the Lower section sound button will start to flash.

The selected sound variation numbers will be shown in the LED display.

The left number represents the Lower section, while the right number represents the Upper section.

When activating FOUR HANDS mode for the first time, the sound of both the Upper and Lower sections will be set to Concert Grand.

□ Step 2

Play the piano.

With FOUR HANDS mode activated, the sounds in the Upper section are transposed two octaves down from the original pitch, while sounds from the Lower section are transposed two octaves up from the original pitch, allowing two people to play within the same key range.

The number of keys used for the Upper and Lower sections can be freely adjusted by changing the Split Point.

- The default Split Point setting is set between E3 and F3.
- When FOUR HANDS mode is activated, the Lower Octave Shift function can be used to adjust the octave range for the Lower section. Please refer to the instructions on page 44 for more information.

□ Step 3

Press the SOUND SELECT buttons to adjust the Upper section sound.

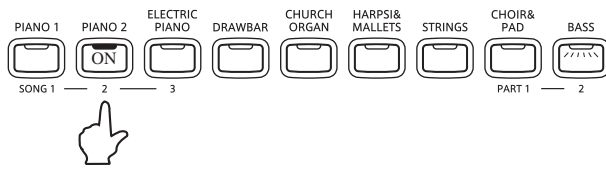

□ Step 4

Press and hold the SPLIT button, then press the SOUND SELECT buttons to adjust the Lower section sound.

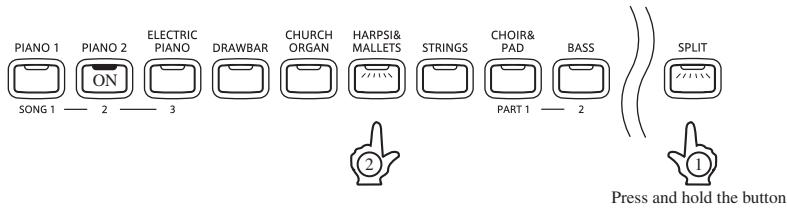

□ Step 5

Press and hold the SPLIT button, then press a key on the keyboard to adjust the Split Point.

- The FOUR HANDS mode Split Point will not affect the SPLIT mode Split Point.

□ Step 6

Press the SPLIT button again to deactivate FOUR HANDS mode.

The LED indicator for the SPLIT button will turn off, and the CN33 digital piano will return to the previously selected sound.

- It is also possible to activate FOUR HANDS mode by using the FOUR HANDS ON/OFF function in the Function menu. Please refer to the instructions on page 50 for more information.

7) REVERB AND EFFECTS

The CN33 digital piano allows performers to alter sounds by adding reverb and applying effects.

When selecting some internal sounds, the LED indicators for the EFFECTS or REVERB buttons may turn on automatically. This is because certain internal sounds are prepared with an effect enabled as the default setting, enhancing tonal quality and improving acoustic realism.

◇ ADDING REVERB

Reverb adds reverberation to the sound, simulating the acoustic environment of a recital room, stage, or concert hall. There are five types of reverb available:

Reverb type	Description
Room 1	Simulates the ambiance of a living room or small rehearsal room.
Room 2	Simulates a larger room than Room 1.
Stage	Simulates the ambiance of a small hall or live stage.
Hall 1	Simulates the ambiance of a concert hall or theatre.
Hall 2	Simulates a larger hall or theatre than Hall 1.

□ Step 1

Press and hold the REVERB button, then press the ▲ or ▼ VALUE buttons to select the desired reverb type.

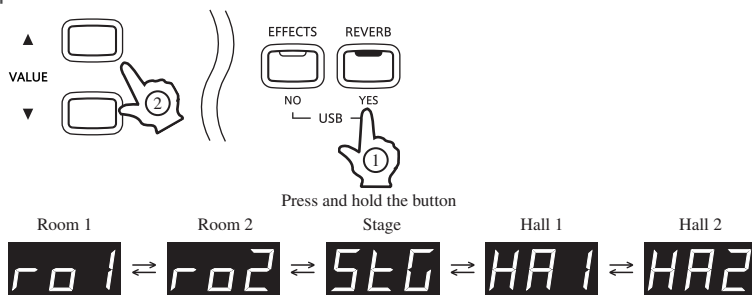

The currently selected reverb type will be shown in the LED display.

□ Step 2

Press the REVERB button again to deactivate the reverb simulation.

The LED indicator for the REVERB button will turn off, indicating that the reverb simulation has been deactivated.

Pressing the REVERB button once again will reactivate the reverb simulation, recalling the previously selected reverb type.

- Reverb settings are specific to each individual sound.
- Any changes made to the reverb type or on/off status will remain until the power is turned off.
- When the power is turned off, the reverb settings will return to the default settings.

◇ APPLYING EFFECTS

Effects alter the impression and feeling of the sounds.

There are seven types of effect available:

Effect type	Description
Chorus	Simulates the rich character of a vocal choir or string ensemble, by layering a slightly detuned version of the sound over the original to enrich it.
Delay 1 Delay 2 Delay 3	Adds an echo to the sound. There are three types of delay available, each with a different length of delay between the echoes.
Tremolo	Adds vibrato to the sound.
Rotary 1 Rotary 2	Simulates the sound of a rotary speaker cabinet commonly used with electronic organs. Rotary 1 is a normal rotary effect while and Rotary 2 adds distortion.

- When either the Rotary 1 or Rotary 2 effect is selected, pressing the Soft pedal will alternate the speed of the rotary speaker simulation between 'Slow' and 'Fast' effect modes.

□ Step 1

Press and hold the EFFECTS button, then press the ▲ or ▼ VALUE buttons to select the desired effect type.

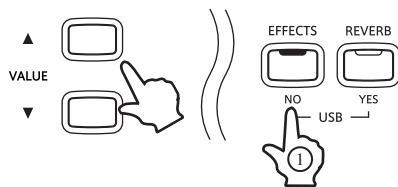

Press and hold the button

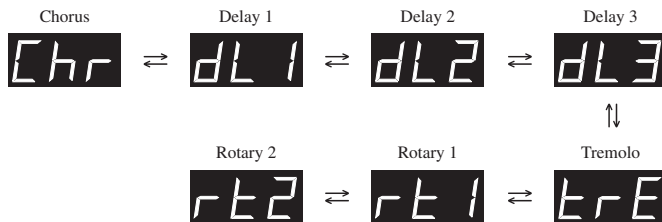

The currently selected effect type will be shown in the LED display.

□ Step 2

Press the EFFECTS button again to deactivate the effects.

The LED indicator for the EFFECTS button will turn off, indicating that the effects have been deactivated.

Pressing the EFFECTS button once again will reactivate the effects, recalling the previously selected effect type.

- Effects settings are specific to each individual sound.
- Any changes made to the effect type or on/off status will remain until the power is turned off.
- When the power is turned off the effects settings will return to the default settings.

8) TRANSPOSE

The TRANSPOSE function allows the audible pitch of the CN33 digital piano to be raised or lowered in half steps. This is particularly useful when accompanying instruments with different tones, or when a song learned in one key must be played in another key. The transpose feature allows the song to be played in the original key, but heard in another key.

□ Step 1

Press and hold the TRANSPOSE button, then press the ▲ or ▼ VALUE buttons to specify the desired transposition value.

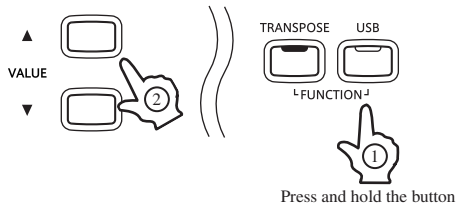

The LED indicator for the TRANSPOSE button will turn on, indicating that the transpose function has been activated.

The currently selected transpose setting will be shown in the LED display.



The pitch can be transposed by up to 12 halftones higher or 12 halftones lower.

Alternatively, while holding the TRANSPOSE button, press the keys from C2 to C4, to set the desired transpose value.

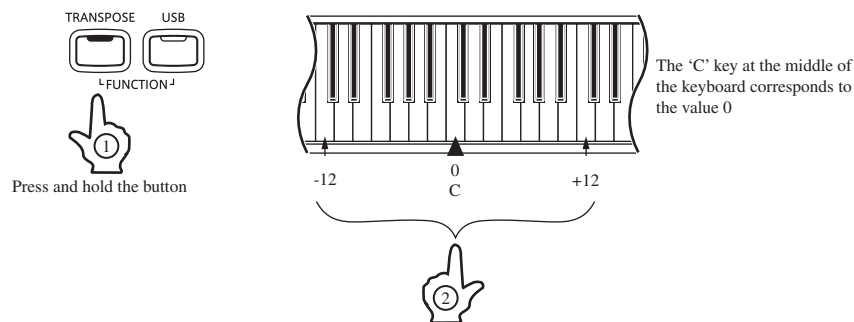

□ Step 1

Press the TRANSPOSE button again to deactivate the transpose function.

The LED indicator for the TRANSPOSE button will turn off, indicating that the transpose function has been deactivated.

Pressing the TRANSPOSE button once again will reactivate the transpose function, recalling the previously selected transpose value type.

- Transpose is active when the LED indicator for the TRANSPOSE button is turned on, and the notes are transposed according to the specified transpose value. For example, if the transpose setting is '-3' and the LED indicator for the TRANSPOSE button is turned on, and the notes will be transposed 3 half steps lower. When the LED indicator for the TRANSPOSE button is turned off, the transpose setting will automatically return to '0' (no transposition) with one touch.
- When the transpose value is set to '0', the LED indicator for the TRANSPOSE button will not turn on.
- Any changes made to the transpose value will remain until the power is turned off.

9) METRONOME

Rhythm is one of the most important elements when learning music. It is important to practice playing the piano at the correct tempo and with a steady rhythm. The CN33 digital piano's metronome function helps learners to achieve this by providing a steady beat to play along with.

◇ STARTING THE METRONOME

- Step 1
Press the TEMPO button.

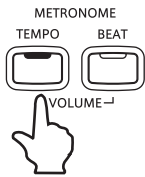

The LED indicator for the TEMPO button will turn on, and the metronome will begin counting with a 4/4 beat.

The metronome tempo in beats per minute (BPM) will be shown in the LED display.

- Step 2
Press the ▲ or ▼ VALUE buttons to adjust the metronome tempo to the desired value.

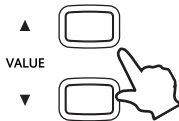

The metronome tempo can be adjusted within the range of 10-400 beats per minute.

- Step 3
Press the TEMPO button again to deactivate the metronome.

The LED indicator for the TEMPO button will turn off, indicating that the metronome has been deactivated.

- Any changes made to the metronome tempo will remain until the power is turned off.
- When the power is turned off, the metronome tempo will return to the default setting of '120' (120 BPM).

◇ CHANGING THE METRONOME TIME SIGNATURE

The metronome produces two types of click, with a bell sound indicating the first beat of a bar - this is a 4-beat or 4/4 time signature. It is possible to select a different signature where appropriate. There are seven different types of time signature available: 1/4, 2/4, 3/4, 4/4, 5/4, 3/8, and 6/8.

- Step 1
Press the BEAT button.

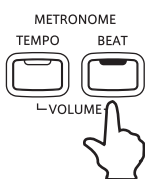

The LED indicator for the BEAT button will turn on and the metronome will begin counting with a 4/4 beat.

The metronome time signature will be shown in the LED display.

□ Step 2

Press the ▲ or ▼ VALUE buttons to select the desired time signature.

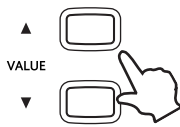

The currently selected time signature will be shown in the LED display.

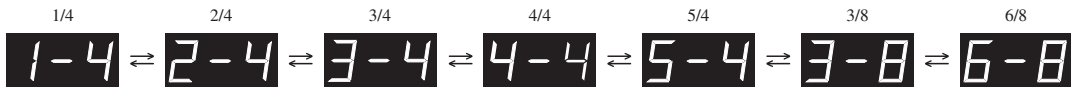

□ Step 3

Press the BEAT button again to deactivate the metronome.

The LED indicator for the BEAT button will turn off, indicating that the metronome has been deactivated.

Both the TEMPO button and the BEAT button can be used to activate and deactivate the metronome, depending on whether the tempo or time signature is being adjusted.

- Any changes made to the metronome time signature setting will remain until the power is turned off.
- When the power is turned off, the metronome time signature will return to the default setting of '4/4'.

◇ ADJUSTING THE METRONOME VOLUME

The volume level of the metronome can also be adjusted.

□ Step 1

Press the TEMPO and BEAT buttons simultaneously.

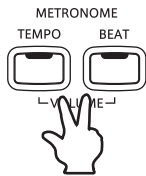

The LED indicators for both the TEMPO and BEAT buttons will turn on, and the metronome will begin counting with the previously selected time signature.



The metronome volume will be shown in the display.

□ Step 2

Press the ▲ or ▼ VALUE buttons to adjust the metronome volume to the desired level.

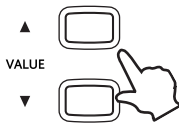

The metronome volume can be adjusted within the range of 1 (soft) to 10 (loud).

□ Step 3

Press the TEMPO and BEAT buttons simultaneously again to deactivate the metronome.

The LED indicators for the TEMPO and BEAT buttons will turn off, indicating that the metronome has been deactivated.

- Any changes made to the metronome volume will remain until the power is turned off.
- When the power is turned off, the metronome volume will return to the default setting of '5'.

10) PANEL LOCK

The Panel Lock function allows the state of all panel buttons to be temporarily locked, preventing sounds and other settings from being changed accidentally while playing the piano.

□ Step 1

Press the CONCERT MAGIC and USB buttons simultaneously.

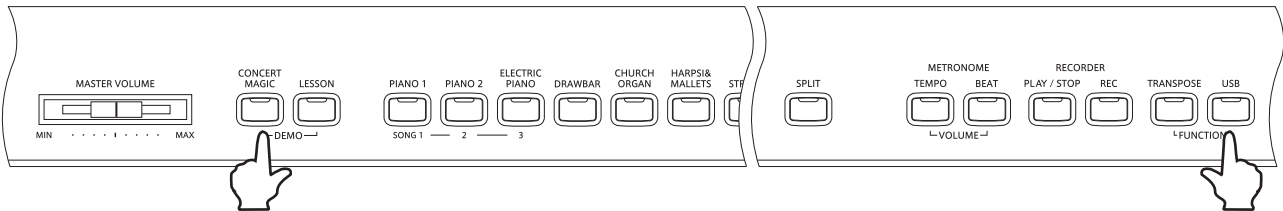

The CN33 control panel will stop responding to button pushes.



The letters 'Lok' will be shown in the LED display, indicating that the button panel is locked.

□ Step 2

Press the CONCERT MAGIC and USB buttons simultaneously again to deactivate the panel lock.

The CN33 control panel will return to normal operation.

- When the power is turned off, the Panel Lock function will be released.

3. CONCERT MAGIC

The great German composer Johann Sebastian Bach once said *"Playing the keyboard is simple. Just strike the right keys at the right time"*. Many pianists wish it were quite that straightforward. Fortunately, KAWAI have devised a method of playing the keyboard that is very simple, without even needing to strike the right keys.

With CONCERT MAGIC, absolutely anyone can sit at the CN33 digital piano and make real music - even complete beginners who have never taken a piano lesson in their life. To enjoy performing with Concert Magic, simply select a favorite piece from the 88 pre-programmed songs and tap any key with a steady rhythm and tempo. Concert Magic will provide the correct melody and accompaniment notes, regardless of which keys are pressed. With Concert Magic anybody, young or old, can enjoy playing music from the moment they sit down at the CN33 digital piano.

◇ SELECTING A SONG

The 88 Concert Magic songs are assigned to each of the 88 keys, and classified by song category into eight groups, such as *Children's Songs*, *American Classics*, *Christmas Songs* etc. Please refer to the separate 'Concert Magic Song List / Lesson Song List' booklet for a complete listing of available Concert Magic songs.

□ Step 1

Press and hold the CONCERT MAGIC button, then press the key to which the desired Concert Magic song is assigned.

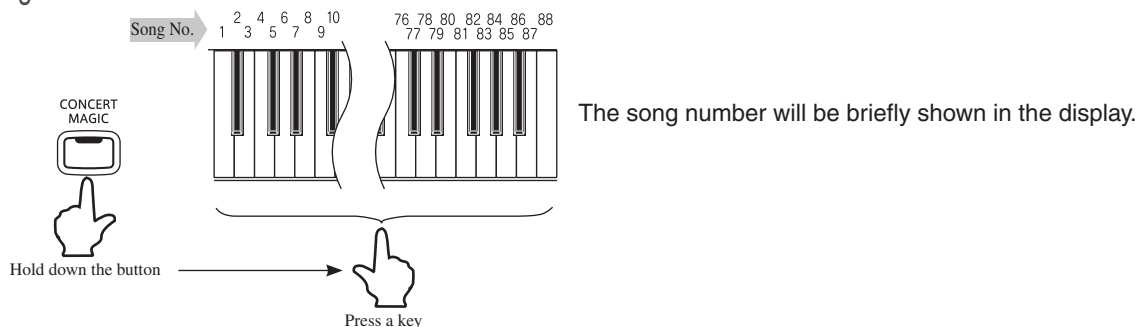

◇ LISTENING TO THE SONG

If the performer is already familiar with the selected Concert Magic song, he/she may wish to begin playing straight away. However, those unfamiliar with the piece may alternatively wish to listen to the song first, before attempting to play it.

□ Step 1

Press the PLAY/STOP button.

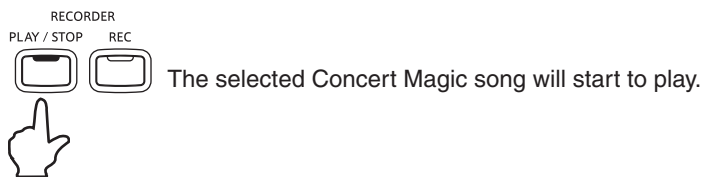

While listening, different Concert Magic songs can be selected by pressing the VALUE buttons.

□ Step 2

Press the PLAY/STOP button again to finish listening to the song.

◇ PERFORMING A SONG

□ Step 1

Tap out the rhythm of the selected song on any black or white key.

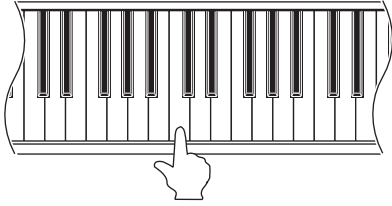

Concert Magic songs will respond to changes in playing style. As the keys are tapped harder, the music will grow louder; if the keys are tapped more softly, the music will become quieter. Tapping faster will cause the music to speed up, while tapping slower will make the music slow down accordingly. Using Concert Magic, even inexperienced pianists can sound like they have been playing for years, simply by pressing one key with one finger.

Concert Magic is a perfect method for small children to learn music, especially when developing a sense of rhythm. For older people who may believe it is too late to learn the piano, Concert Magic offers an enjoyable first step. With Concert Magic, the CN33 digital piano can be enjoyed by everyone in the family, even those who have never touched a musical instrument in their life.

◇ CONCERT MAGIC PART VOLUME BALANCE

When used with Concert Magic, the BALANCE slider adjusts the volume balance of the melody part and the accompaniment.

□ Step 1

Use the BALANCE slider to adjust the volume balance.

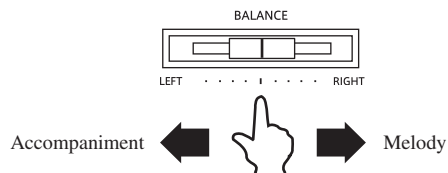

As the slider is moved to the right, the sound of the melody becomes louder and the accompaniment becomes softer. The balance changes in the opposite way when the slider is moved to the left.

◇ CONCERT MAGIC SONG ARRANGEMENT TYPES

After playing with Concert Magic for a while, performers may feel that such playing is too easy and that there is very little to learn. While it is true that some of the songs are very easy to play, even for beginners, there are also some songs which will prove challenging, and require practice to play proficiently.

Each of the 88 Concert Magic songs fall into one of three different arrangement types, depending on the skill level required to perform them.

■ EASY BEAT

These are the easiest songs to play. To perform them, simply tap out a constant steady beat on any key on the keyboard. Look at the following example, 'Für Elise'. Press the key with a steady sixteenth note rhythm.

Key on X X X X X X X X X X X X X X X X X X X X X X X X

The image shows a musical score for 'Für Elise' in 3/8 time. Above the staff, there are two rows of 'X' marks representing a steady sixteenth note rhythm. The treble clef staff contains a melody of sixteenth notes, and the bass clef staff contains a simple accompaniment of eighth notes.

■ MELODY PLAY

These songs are also quite easy to play, especially if they are familiar to the player. To perform them, tap out the rhythm of the melody on any key on the keyboard. Singing along as the rhythm is tapped can be helpful. Play 'Twinkle, Twinkle, Little Star' for example. Follow the melody's rhythm as shown.

Key on X X X X X X X X X X X X X X

The image shows a musical score for 'Twinkle, Twinkle, Little Star' in common time (C). Above the staff, there are two rows of 'X' marks representing the melody's rhythm. The treble clef staff contains a simple melody of quarter notes, and the bass clef staff contains a simple accompaniment of chords.

When performing fast songs with Concert Magic, it is sometimes easier to tap two different keys with two alternating fingers in order to play at greater speed.

■ SKILLFUL

These songs range in difficulty from moderately difficult to difficult. To perform them, tap out the rhythm of both the melody and the accompaniment notes on any key on the keyboard, such as 'Waltz of the Flowers' shown below.

Key on X X X X X X X X X X X X X

The image shows a musical score for 'Waltz of the Flowers' in 3/4 time. Above the staff, there are two rows of 'X' marks representing the rhythm of both the melody and the accompaniment. The treble clef staff contains a melody of quarter notes, and the bass clef staff contains a simple accompaniment of chords.

It may take a little practice to perform the Concert Magic songs proficiently. A good way to learn is to listen to these pieces first, and then try to tap out the rhythms that are heard.

- The separate 'Concert Magic Song List / Lesson Song List' booklet lists the arrangement type next to each song title as 'EB' for Easy Beat, 'MP' for Melody Play and 'SK' for Skillful.

◇ STEADY BEAT

Steady Beat allows Concert Magic songs to be played by simply tapping any key with a constant steady beat, regardless of the song arrangement type.

□ Step 1

Press and hold the CONCERT MAGIC button.



The currently selected Concert Magic mode will be shown in the LED display.

□ Step 2

While still holding the CONCERT MAGIC button, use the VALUE button to change the Concert Magic mode to STEADY BEAT (C-2).

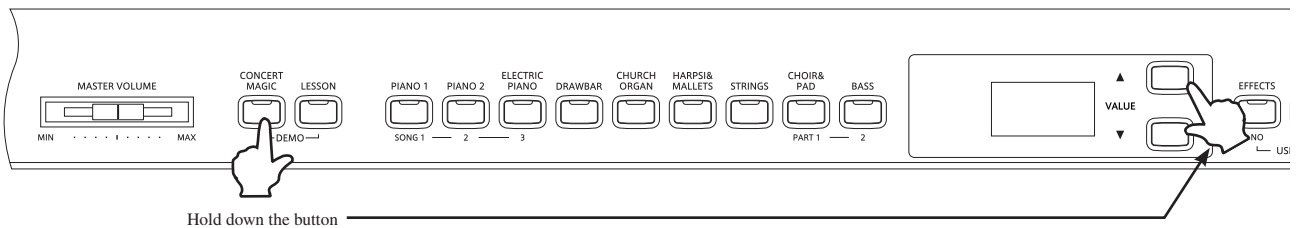

□ Step 3

Start by tapping any key with a constant steady beat.

The tapping speed will set the tempo for the song. Both the accompaniment and melody parts will be played automatically in time with the tapped tempo.

◇ CONCERT MAGIC DEMO MODES

There are three ways to listen to the Concert Magic songs in the DEMO mode.

◆ ALL PLAY

Press the CONCERT MAGIC button and then press the PLAY/STOP button without selecting a song. The CN33 digital piano will play back all of the Concert Magic songs in order.

◆ RANDOM PLAY

Press the CONCERT MAGIC button and then press the LESSON button. The CN33 digital piano will play back all of the Concert Magic songs in random order.

◆ CATEGORY PLAY

Press and hold the CONCERT MAGIC and LESSON buttons and press the piano key to which the desired song is assigned. The CN33 digital piano will play back the selected song and then continue to play the rest of the songs in the same category.

To stop the demo, press the PLAY/STOP button.

◇ CONCERT MAGIC PLAYBACK SPEED

The TEMPO button is also used to adjust the playback speed of Concert Magic songs.

□ Step 1

After selecting a Concert Magic song to play back, press and hold the TEMPO button.

120

The current tempo will be shown in the LED display.

□ Step 2

While holding down the TEMPO button, use the VALUE buttons to change the tempo.

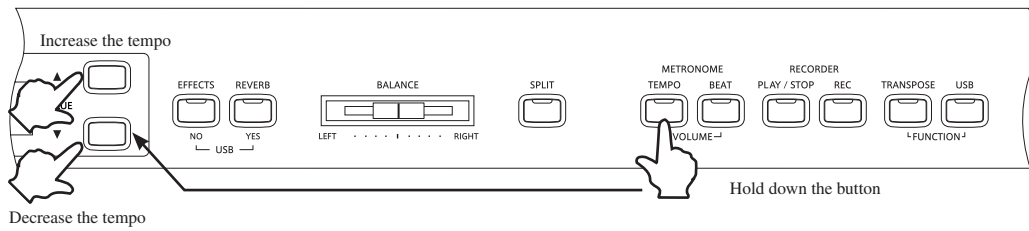

The tempo of the selected Concert Magic song can be adjusted either before play back, or while the song is playing.

4. LESSON FUNCTION

The CN33 digital piano's Lesson function helps performers to practice the piano with a collection of etudes from Czerny and Burgmüller, or songs from *Alfred's Basic Piano Library* and *Alfred's Premier Piano Course* lesson books (USA, Canada, Australia and UK only). It is possible to listen to each etude or song at various tempos, practicing the left and right hand parts separately, before eventually recording a practice session for self-evaluation.

Alfred's Basic Piano Library and *Alfred's Premier Piano Course* lesson books are sold separately. Please check with local dealers or contact Alfred's customer service by telephoning 818-892-2452 (USA & Canada), 0-95240033 (Australia), +44 (0)1279828960 (UK). Or alternatively, by e-mailing customerservice@alfred.com.

1) SELECTING A BOOK/SONG

□ Step 1

Press the LESSON button.

The LED indicator for the LESSON button will turn on to indicate that lesson mode is enabled.

An alphabet letter and a 2-digit number will be shown in the LED display. The alphabet letter refers to a song book and the 2-digit number refers to a song number.

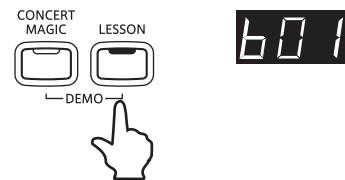

Lesson availability differs according to geographical location:

	Letter	Lesson Book Name
US, Canada, UK, Australia	A	Alfred's Premier Piano Course Lesson 1A
	B	Alfred's Premier Piano Course Lesson 1B
	C	Alfred's Basic Piano Library Lesson Book Level 1A
	D	Alfred's Basic Piano Library Lesson Book Level 1B
Rest of the World	B	Burgmüller: 25 Progressive Pieces, Opus 100
	C	Czerny: 30 Czerny Etudes de Mécanisme, Opus 849

□ Step 2

Press and hold the LESSON button, then press the ▲ or ▼ VALUE buttons to select the desired lesson book type.

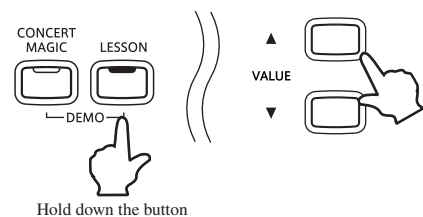

□ Step 3

Press the ▲ or ▼ VALUE buttons (without holding the LESSON button) to select the desired lesson song.

It is also possible to select a song directly by holding down the LESSON button and pressing a key on the keyboard. Please refer to the separate 'Concert Magic Song List / Lesson Song List' booklet for a complete listing of available lesson songs.



2) LISTENING TO AND PLAYING A SONG

□ Step 1

Press the **PLAY/STOP** button to play the selected song.

There will be a one bar count-in before the song starts to play.

Press the **PLAY/STOP** button to stop and reset the song.

If the **PLAY/STOP** button is pressed again, the song will restart from the beginning.

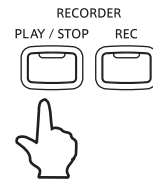

◇ EXITING THE LESSON FUNCTION

□ Step 1

Press the **LESSON** button.

The LED indicator of the **LESSON** button will turn off, and the CN33 digital piano will return to normal operation mode.

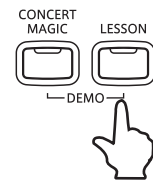

◇ PRACTICING THE LEFT AND RIGHT-HAND PARTS

The volume balance of the left and right-hand parts can be adjusted using the **BALANCE** slider.

□ Step 1

Use the **BALANCE** slider to adjust the volume balance.

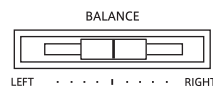

Decreases the volume of the right-hand part



Decreases the volume of the left-hand part

Moving the balance slider partially to the left will gradually decrease the volume of the right-hand part, allowing the right-hand part to be practiced while the pre-recorded part plays softly as a guide. When the balance slider is moved fully to the left, the pre-recorded right-hand part will be muted completely.

◇ ADJUSTING THE TEMPO OF A SONG

□ Step 1

Press and hold the **TEMPO** button then press the ▲ or ▼ **VALUE** buttons to increase or decrease the tempo of the song.

To reset the tempo to the default speed, select another song.

3) RECORDING A SONG PRACTICE

While in Lesson mode, song practice can be recorded for playback and self-evaluation. The pre-recorded left and right-hand parts will be heard while the song practice is recorded. As noted previously, the BALANCE slider may be used to mute either pre-recorded left or right-hand parts.

□ Step 1

Use the BALANCE slider to adjust the volume balance.

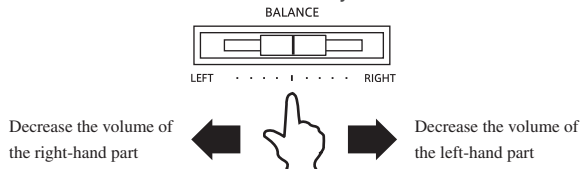

□ Step 2

Press the REC button.

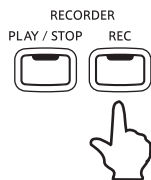

There will be a one bar count-in before the recording starts.

□ Step 3

Press the PLAY/STOP button again to stop the recording and reset the song to the beginning.

Recording will also stop automatically at the end of the lesson song.

◇ PLAYING BACK THE RECORDING

□ Step 1

Press the PLAY/STOP button to listen to the recording.

The recorded performance will be played. The left and right-hand playing volume can be changed using the BALANCE slider.

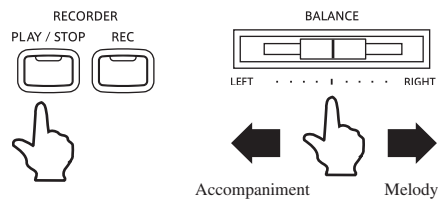

◇ ERASING THE RECORDING

□ Step 1

Press the PLAY/STOP and REC buttons simultaneously to erase the recording.

- Recordings made while using the Lesson function cannot be saved and are intended for temporary reference only. When changing to another song, exiting the Lesson function or turning off the CN33 digital piano power, Lesson recordings will be erased.
- Preset Lesson songs cannot be permanently overwritten or erased.

5. RECORDER

The RECORDER function records performances in a similar way to that of a tape recorder. However, the CN33 digital piano records songs as digital data, instead of audio data - storing the music inside the instrument. Because each song is stored digitally, it is possible to modify various aspects during playback, such as adjusting the tempo without changing the pitch, or selecting different sound types and effects settings. Once fully understood, the recorder function provides an easy to use tool for both practicing and playing the piano.

1) RECORDING (REC BUTTON)

The CN33 digital piano allows up to three different songs to be recorded, stored in memory, and played back at the touch of a button. Each song has two separate tracks called 'Parts' that can be recorded independently. This allows the left-hand part to be recorded first on one track, then the right-hand part to be recorded later on the other track, while listening to the first part.

When recording or playing back a song, each part (track) can be re-recorded or played back freely. Attempting to re-record a part will automatically erase all previously recorded performance information for that part, therefore when recording parts separately, it is most important to select the correct part carefully, in order to prevent accidentally overwriting a previously recorded part.

The REC button is used for recording.

The SONG buttons and PART buttons correspond to the SOUND SELECT buttons.

□ Step 1

Press and hold the REC button, then select a SONG (1, 2 or 3) and PART number (1 or 2).

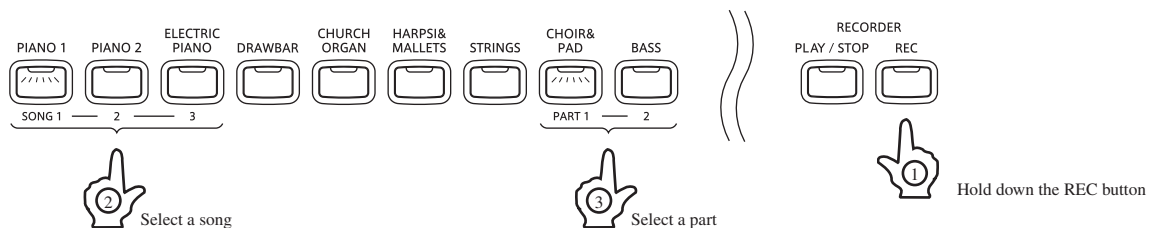

While pressing the REC button, the LED indicators for one SONG button and one PART button will start to flash, indicating the song and the part to be recorded.

During this time, the SONG and PART to be recorded can be changed freely by pressing the desired SONG or PART button.

If no PART is selected PART1 will be selected automatically.

When the REC button is released, the LED indicators for the selected SONG and PART buttons will stop flashing and the LED indicator for the REC button will turn on. This is the Standby state for recording. Furthermore, the LED indicator for the SOUND SELECT button will also turn on, allowing the sound for recording to be changed.

- Step 2
Start to play the piano.

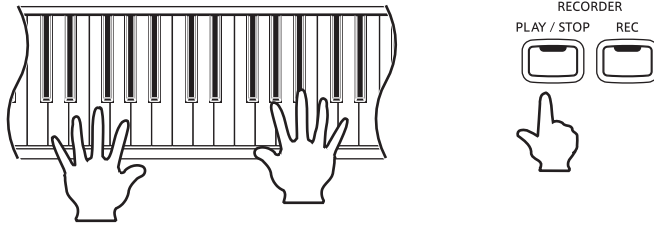

The recorder will automatically start recording with the first note played. During this time, the LED indicators for the REC and PLAY/STOP buttons will be turned on. Any changes made to the sound while recording will also be recorded. The recording can be started by pressing the PLAY/STOP button instead of pressing a key, allowing a blank bar to be inserted at the beginning of a song.

- Step 3
Press the PLAY/STOP button to stop recording.

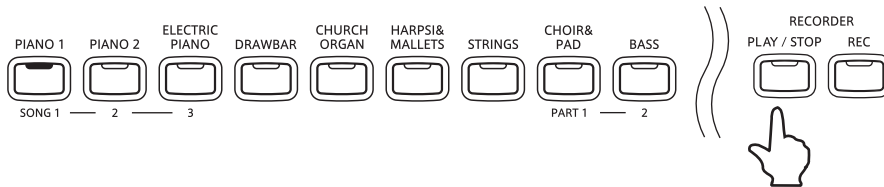

The LED indicators for the PLAY/STOP button and the REC button will turn off and the newly recorded part will be saved to memory automatically. Saving may take a few moments and during this time the piano will not respond to any other operations. To record the piece again, simply repeat the above procedure. The new recording will completely erase the previous one.

◇ RECORDING A SECOND PART

A second part can be recorded in the second track of the same song. After recording the first part, select the other track and record the second part.

- Step 1
Press and hold the REC button again and press the BASS button to select to record PART2.

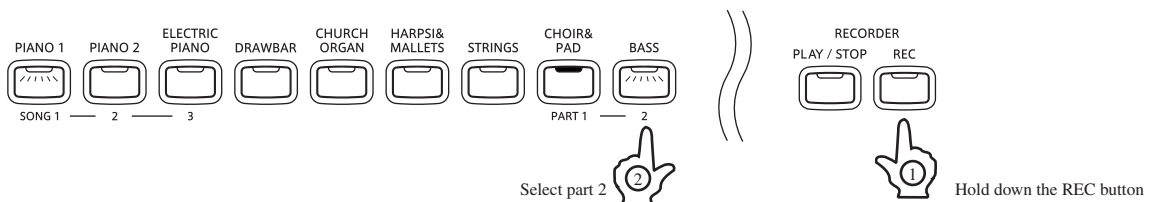

The LED indicators for the SONG1 button and PART2 button will start to flash, indicating that they are selected for recording. Furthermore, the LED indicator for the PART1 button will now be turned on, indicating that PART1 has already been recorded.

- **Step 2**
Start to play the piano.

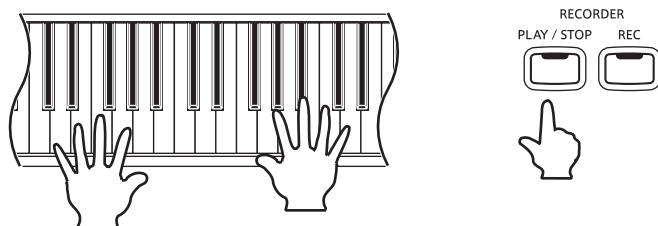

While recording the second part, the previously recorded first part will also play. During this time, the LED indicators for the REC button and PLAY/STOP button will be turned on.

To start playing back the first part and then recording the second part from a certain point, later in the song, press the PLAY/STOP button instead of playing the keyboard to start playback, then begin recording the second part when necessary.

- **Step 3**
Press the PLAY/STOP button to finish recording.

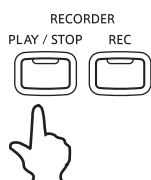

The LED indicators for the PLAY/STOP button and the REC button will turn off and the newly recorded part will be saved to memory automatically.

- The total recording capacity of the CN33 digital piano's memory is approximately 15,000 notes, with button and pedal presses also counted as one note.
When the maximum capacity is reached, recording will stop and all music recorded up until that point will be saved to memory automatically.
- Performance data stored inside the CN33 digital piano's memory will be saved even after turning off the power.
- It is possible to temporarily turn off (mute) a previously recorded part, for example PART1, before recording a new part, for example PART2. This function can be useful to avoid distraction while recording. To mute PART1, hold the PLAY/STOP button and press the PART1 button, the LED indicator for PART1 will turn off.
- Panel operations stored during recording:
 - Changes made to the sound type.
 - Shifts between DUAL and SPLIT modes.
- Panel operations NOT stored during recording:
 - Changes made to effect settings – the selected effect will be applied to the selected sound type.
 - Changes made to temp (the tempo set immediately before recording will be stored, however).
 - Changes made using the BALANCE slider in DUAL or SPLIT modes – the volume balance set immediately before recording will be stored, however.
 - Turning the TOUCH CURVE or TRANSPOSE functions ON or OFF – regardless of the transpose settings the performance will be replayed at the pitch originally used for the recording.

2) PLAYING BACK A SONG

The PLAY/STOP button is used to start and stop playback of the recorded song, and to also select which song and part is played.

□ Step 1

Press the PLAY/STOP button to start playing the recorded song.

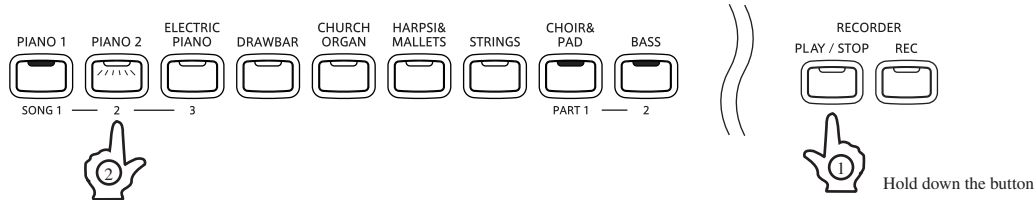

Press the PLAY/STOP button again to stop playback.

To select a different song for playback, hold the PLAY/STOP button and press the SOUND SELECT button that corresponds to the desired song. The song will begin playback when the two buttons are released.

- While the song is being played, performance information is also sent to supported devices as MIDI data (See page 47).
PART1 is sent on 1ch and PART2 is sent on 2ch. When recording in DUAL mode, additional information for PART1 is sent on 9ch and additional information for PART2 is sent on 10ch.

◇ PLAYING BACK RECORDED PARTS SEPARATELY

When selecting a song recorded with two parts, it is possible to playback PART1 and PART2 separately.

First hold the PLAY/STOP button. If LED indicators corresponding to PART1 and PART2 turn on, both parts have been recorded successfully. Releasing the PLAY/STOP button will begin playing PART1 and PART2 simultaneously.

□ Step 1

Press and hold the PLAY/STOP button, then press the SOUND SELECT button that corresponds to either PART1 or PART2.

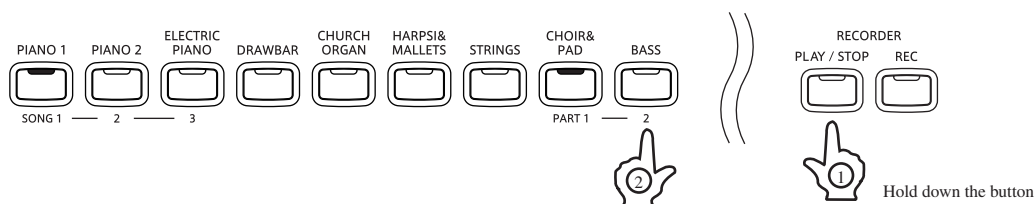

The LED indicator will turn off accordingly, indicating that the part will not be played back.

The song will begin playback when the PLAY/STOP button is released.

3) ERASING A SONG

This function allows any songs that are no longer listened to, to be cleared.

□ Step 1

Press and hold the REC and PLAY/STOP buttons.

The LED indicators will display which songs have been recorded.

□ Step 2

While holding the REC and PLAY/STOP buttons, select the desired song to be erased by pressing the corresponding SOUND SELECT button.

The LED indicator of the selected song will start to flash.

□ Step 3

While still holding the REC and PLAY/STOP buttons, select the desired PART to be erased by pressing the corresponding SOUND SELECT button.

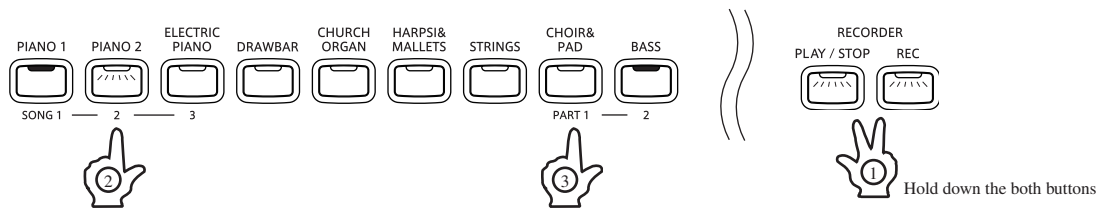

The LED indicator of the selected PART will turn off, indicating that the part has been erased.

In the diagram above, PART1 of Song 2 is erased.

When both PART1 and PART2 of a song are erased, the song becomes empty. Selecting the song only, without selecting PART1 and/or PART2, will not erase it.

- Repeat the steps above in order to erase a number of songs and parts.
- To erase all songs from memory at once, first turn off the power and then turn it on again, holding down both the REC button and the PLAY/STOP button.

6. USB OPERATIONS

The CN33 digital piano allows recorder songs to be loaded from and saved to a USB memory device. It is also possible to play songs directly, delete files, and to format the USB memory device.

1) USB PLAY

The USB Play function is used to play songs directly from a USB memory device, without loading it into one of the instrument's internal recorder memories.

The USB Play function recognises SMF (Standard MIDI File) format songs, however as the CN33 does not contain the full General MIDI/GM2 sound bank selection, some SMF song files may not be reproduced entirely accurately when played through the instrument.

- Step 1**
After connecting a USB device, press the USB button.

- Step 2**
Press the ▲ or ▼ VALUE buttons to select the USB Play function, then press the YES button.

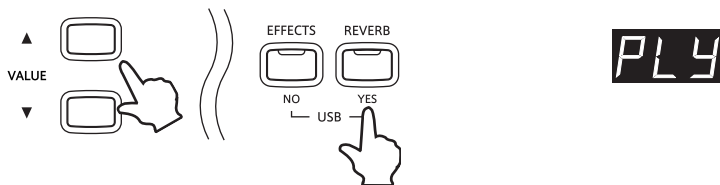

- Step 3**
Press the ▲ or ▼ VALUE buttons to select the song to PLAY, then press the PLAY/STOP button.

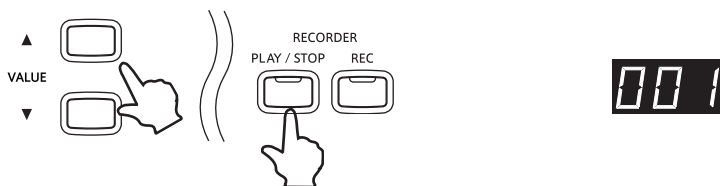

The selected song will start to play.

- CN33 format songs will be shown in the LCD display as U01, U02...U99. etc.
- SMF format songs will be shown in the LCD displayed as 001, 002... 999, etc.

If the PLAY/STOP button is pressed and held for a few second, the USB Play function will enter 'Chain Play' mode, first playing the selected song, then advancing automatically to the next song in numerical order.

- While the song is playing, press the ▲ or ▼ VALUE buttons to increase/decrease the playback volume, and the YES or NO buttons to fast forward or rewind the playing position.

- Step 4**
Press the USB button to exit the USB Play function and return to normal operation.

2) USB LOAD

The USB Load function allows recorder songs stored on a USB memory device to be loaded into the instrument's internal memory.

- **Step 1**
After connecting a USB device, press the USB button.

- **Step 2**
Press the ▲ or ▼ VALUE buttons to select the USB Load function, then press the YES button.

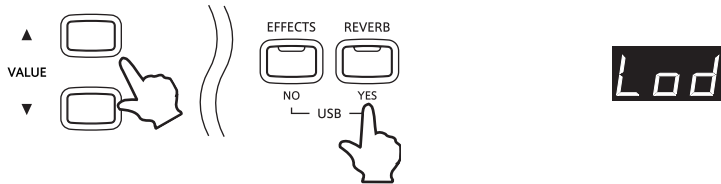

- **Step 3**
Press the ▲ or ▼ VALUE buttons to select the song to be loaded into internal memory.



- **Step 4**
Press the Song button to select the location (song number) that the song will be loaded into, then press the YES button.

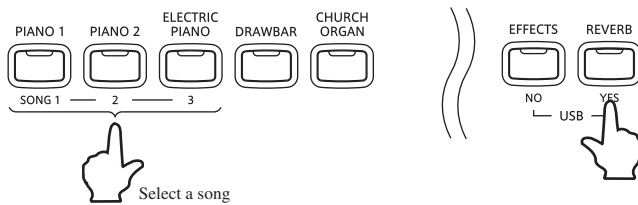

- Up to 3 different songs can be loaded and stored in internal memory.
- Any existing recorder song data will be replaced by the loaded song.
- After loading a song, please follow the '5-2 PLAYING BACK A SONG' instructions on pp.36

- **Step 5**
Press the USB button to exit the USB Load function and return to normal operation.

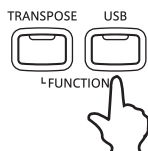

3) USB SAVE

The Save Song function allows recorder songs stored in the instrument's internal memory to be saved to a USB memory device.

- **Step 1**
After connecting a USB device, press the USB button.

- **Step 2**
Press the ▲ or ▼ VALUE buttons to select the USB Save function, then press the YES button.

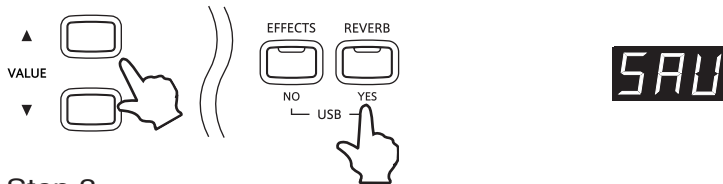

- **Step 3**
Press the Song button to select the recorder song to be saved to a USB memory device. If the selected recorder song contains song data, the button LED will flash.

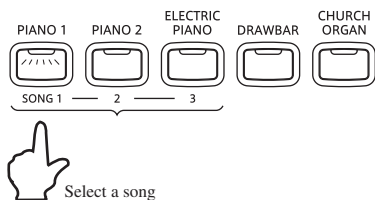

- **Step 4**
Press the ▲ or ▼ VALUE buttons to select the desired number for the song, then press the YES button.

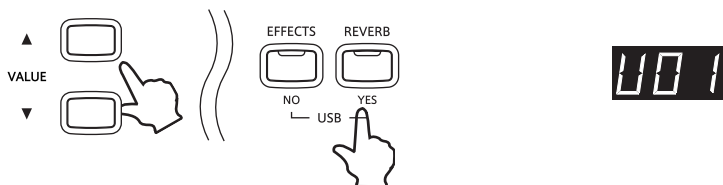

Overwriting the file:

If the song number already exists, 'Sur' will be shown in the display.

Press the YES button to confirm the song save operation, or the NO button to cancel.



- The saved song file will be stored in the root folder of the USB memory device. It is not possible to store the song file in a different folder.
- Renaming or re-saving the song file using a computer may prevent the song from being loaded into the instrument's internal memory.

- **Step 5**
Press the USB button to exit the USB Save function and return to normal operation.

4) USB DELETE

The Delete function allows song files stored on a USB memory device to be deleted.

□ Step 1

After connecting a USB device, press the USB button.

□ Step 2

Press the ▲ or ▼ VALUE buttons to select the USB Delete function, then press the YES button.

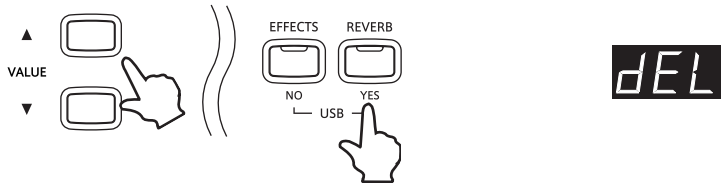

□ Step 3

Press the ▲ or ▼ VALUE buttons to select the file to be deleted, then press the YES button.

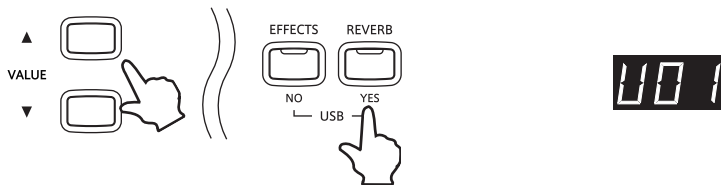

□ Step 4

A confirmation message will be shown in the display.

Press the YES button to confirm the song delete operation, or the NO button to cancel.



The selected song will be deleted.

□ Step 5

Press the USB button to exit the USB Delete function and return to normal operation.

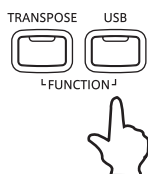

5) USB FORMAT

The Format function allows a USB memory device to be formatted, erasing all stored data.

□ Step 1

After connecting a USB device, press the USB button.

□ Step 2

Press the ▲ or ▼ VALUE buttons to select the USB Format function, then press the YES button.

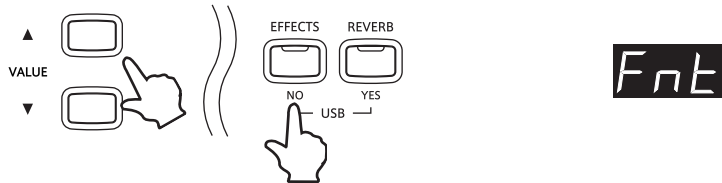

□ Step 3

An initial confirmation message will be shown in the display.

Press the YES button to confirm the format operation, or the NO button to cancel.

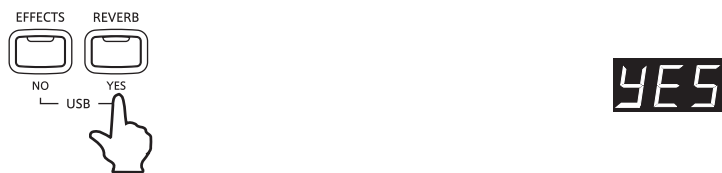

A second confirmation message will be shown in the display.

Press the YES button again to confirm the format operation, or the NO button to cancel.



The connected USB device will be formatted, erasing all stored data.

□ Step 4

Press the USB button to exit the USB Format function and return to normal operation.

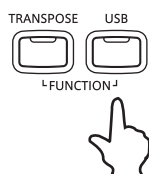

7. FUNCTION BUTTONS

The function settings are responsible for controlling various advanced parameters within the CN33 digital piano, and can be selected by pressing a combination of buttons.

◇ ENTERING A FUNCTION MODE

□ Step 1

Press and hold the TRANSPOSE and USB buttons, then press one of the other panel buttons shown below.

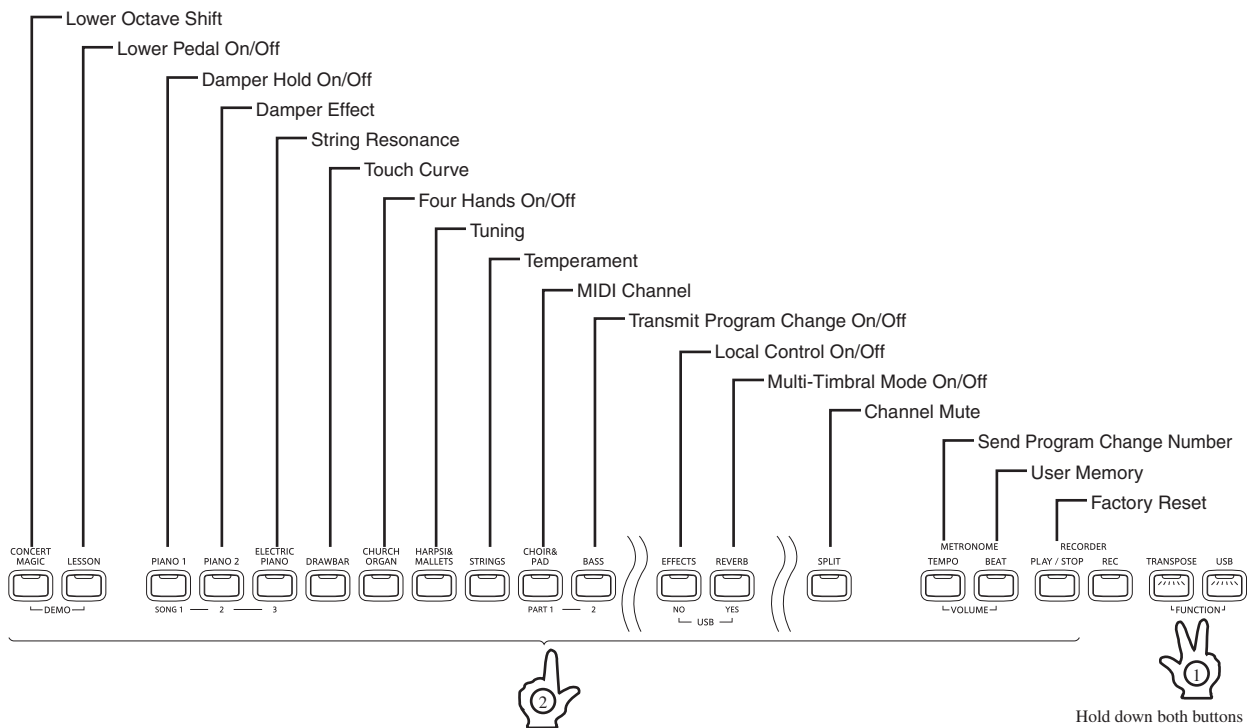

The LED indicator for the corresponding button will start to flash, indicating that the function is selected.

◇ EXITING A FUNCTION MODE

□ Step 1

Press any of the panel buttons shown below.

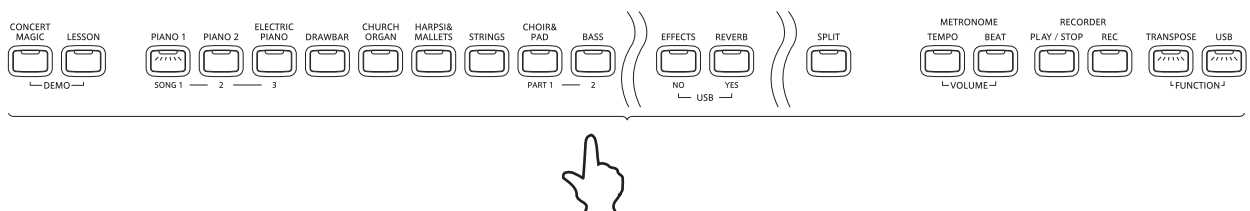

The LED indicator for the button will stop flashing and return to its normal state.

When the power is turned off, settings will be reset to the factory default value.

1) LOWER OCTAVE SHIFT

This function allows the lower part to be raised by one, two, or three octaves when using SPLIT mode.

□ Step 1

Press and hold the TRANSPOSE and USB buttons, then press the CONCERT MAGIC button.

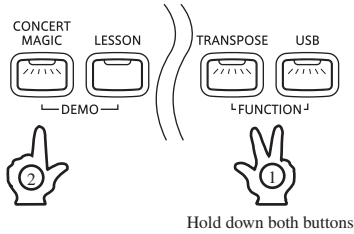

Hold down both buttons

The display will alternate between showing 'Lot' (Lower Octave) and a number, representing how many octaves the lower part is shifted up.

□ Step 2

Press the ▲ or ▼ VALUE buttons to set the desired lower octave shift range.

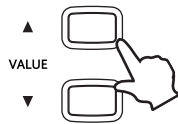

Lower Octave Shift

Lot

0 ~ 3

Lower Octave Shift can be set from 0 to 3.

■ The CN33 digital piano's lower octave shift setting defaults to '0' each time the power is turned on.

2) LOWER PEDAL ON/OFF

This function determines whether or not pressing the damper pedal will also sustain the Lower section sounds when in SPLIT mode. The default setting is off, which means the sustain pedal is not active for lower part sound. The sustain pedal will still be active for the upper sound.

□ Step 1

Press and hold the TRANSPOSE and USB buttons, then press the LESSON button.

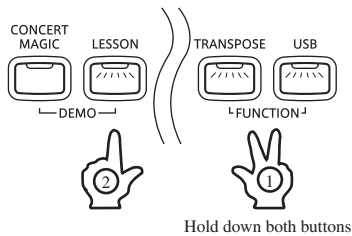

The display will alternate between showing 'LPd' (Lower Pedal) and on/off status. The default is off.

□ Step 2

Press the ▲ or ▼ VALUE buttons to toggle lower pedal on and off.

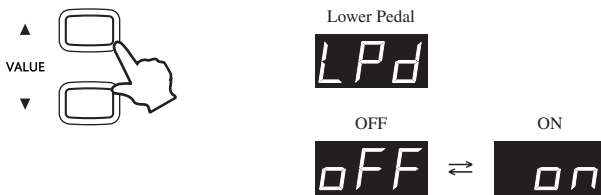

■ The CN33 digital piano's lower pedal setting defaults to 'OFF' each time the power is turned on.

3) DAMPER HOLD ON/OFF

This determines if the sound such as organ or strings should be held (on) or gradually decayed (off) when the damper pedal is depressed.

□ **Step 1**

Press and hold the TRANSPOSE and USB buttons, then press the PIANO 1 button.

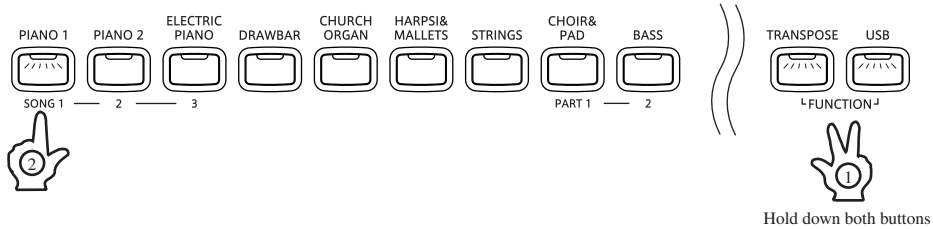

The display will alternate between showing 'dMP' (Damper) and on/off status. The default is off.

□ **Step 2**

Press the ▲ or ▼ VALUE buttons to toggle damper hold on and off.

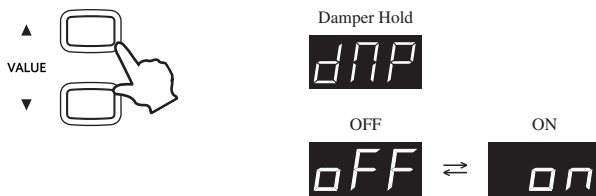

4) DAMPER EFFECT

When the damper pedal is depressed on an acoustic piano, all dampers are lifted up, allowing the strings to vibrate freely. When a note or chord is played on the piano with the damper pedal depressed, not only will the strings of the notes played vibrate, but also the strings of other notes, vibrating in sympathetic resonance. The Damper Effect function of the CN33 digital piano attempts to simulate this phenomenon.

□ Step 1

Press and hold the TRANSPOSE and USB buttons, then press the PIANO 2 button.

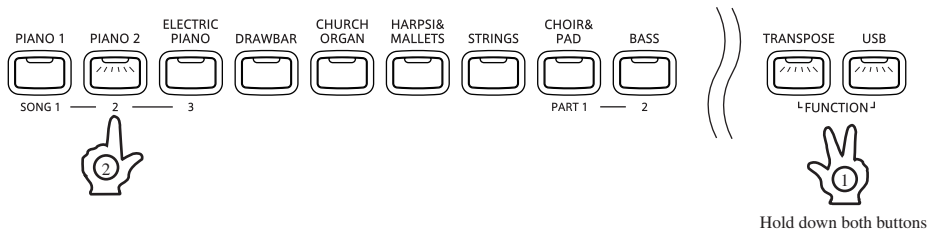

The display will alternate between showing 'dEF' (Damper Effect) and a number that represents the value.

□ Step 2

Press the ▲ or ▼ VALUE buttons to select the desired setting.

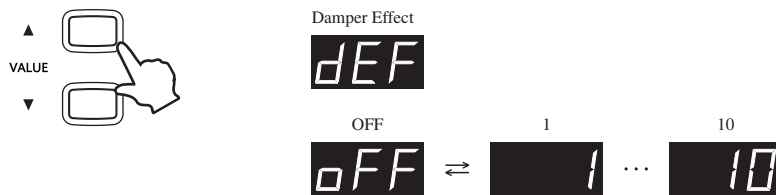

5) STRING RESONANCE

String Resonance refers to a phenomenon present among acoustic pianos, whereby the strings of held notes resonate 'sympathetically' with other notes of the same harmonic series. The String Resonance function of the CN33 digital piano attempts to simulate this phenomenon.

□ Step 1

Press and hold the TRANSPOSE and USB buttons, then press the ELECTRIC PIANO button.

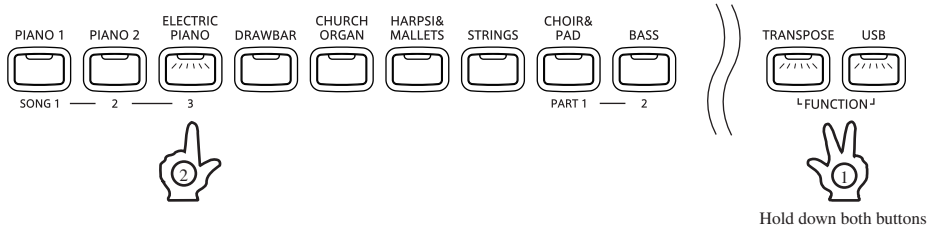

The display will alternate between showing 'Str' (String Resonance) and a number that represents the volume.

□ Step 2

Press the ▲ or ▼ VALUE buttons to set the volume within a range of 'Off', 1 to 10.

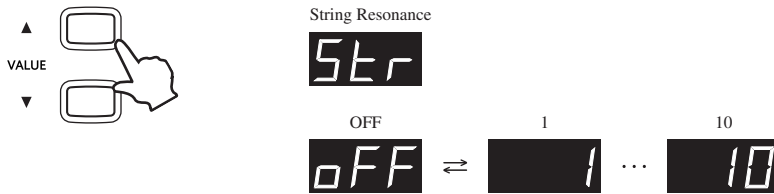

5 is the default setting.

String resonance will not be active when 'Off' is selected.

■ About string resonance

Even when the sustain pedal is not depressed on an acoustic piano, the strings for any notes held will be un-damped and will resonate freely in sympathy with the strings of other notes that are played if they are part of the same harmonic series. In addition, adjacent notes will also be resonated. The string resonance function simulates this phenomenon. This is called "string resonance."

For example, when you play the keys shown below while holding down the C key, the string of the C key resonates and produces a sound.

(Quietly press and hold down the C key, and then quickly tap each of the keys shown below. It should be possible to hear the string resonate.)

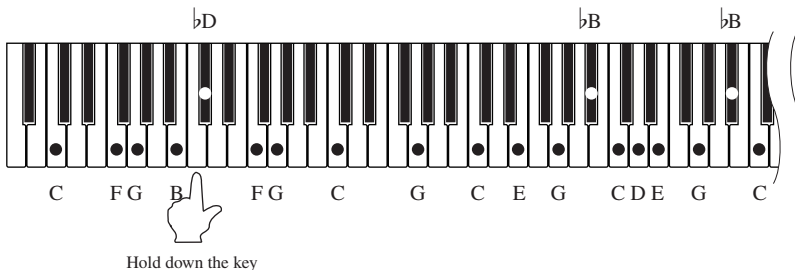

Hold down the key

- When a key is played while holding down an adjacent key, an acoustic piano produces a sound as a result of string resonance. The CN33 digital piano simulates this phenomenon.
- The string resonance volume defaults to '5' each time the power is turned off.
- String resonance is not active when the sustain pedal is depressed.
- The string resonance function is effective only for the acoustic piano sounds.

6) TOUCH CURVE

The TOUCH function allows different touch sensitivities for the keyboard to be selected, other than the standard touch of an acoustic piano. The sensitivity can be changed to one of five different types: Light 2, Light 1, Heavy 1, Heavy 2 or Off.

①Light 2	: For players with a delicate touch. Requires less striking force to achieve a forte note.
②Light 1	: For those still developing finger strength. A louder volume is produced even when playing with a soft touch.
③Normal	: Reproduces the standard touch sensitivity of an acoustic piano.
④Heavy 1	: Perfect for those with strong fingers. Requires a heavier touch to produce a loud volume.
⑤Heavy 2	: Requires more striking force to achieve a loud volume.
⑥Off	: A constant volume is produced regardless of how hard the keys are struck. This setting is suitable for sounds that have a fixed dynamic range such as Organ and Harpsichord.

□ Step 1

Press and hold the TRANSPOSE and USB buttons, then press the DRAWBAR button.

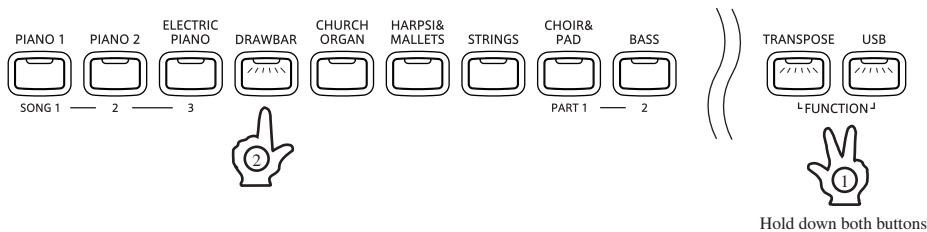

□ Step 2

Press the ▲ or ▼ VALUE buttons to select the desired TOUCH type.

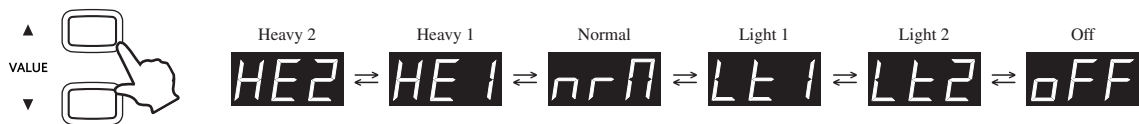

The currently selected touch type will be shown in the LED display.

- The touch setting is global for all of the internal sounds. It is not possible to have individual touch settings for each internal sound.
- When the power is turned off, the touch settings will return to the default setting of 'Normal'.
- Note: LIGHT and HEAVY do not represent the physical weight of the keys. The touch type affects the sensitivity of the keys, determining the volume level in response to the key movement.

7) FOUR HANDS ON/OFF

This function allows FOUR HANDS mode to be activated or deactivated using an alternative method.

□ Step 1

Press and hold the TRANSPOSE and USB buttons, then press the CHURCH ORGAN button.

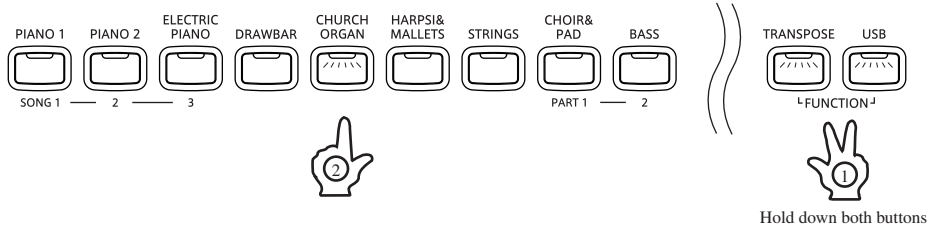

The display will alternate between showing '4Hn' (FOUR HANDS) and on/off status. The default is off.

□ Step 2

Press the ▲ or ▼ VALUE buttons to toggle FOUR HANDS on and off.



8) TUNING

The TUNING function allows the CN33 digital piano's pitch to be finely adjusted, and may prove useful when playing with other instruments.

□ Step 1

Press and hold the TRANSPOSE and USB buttons, then press the HARPSI & MALLETS button.

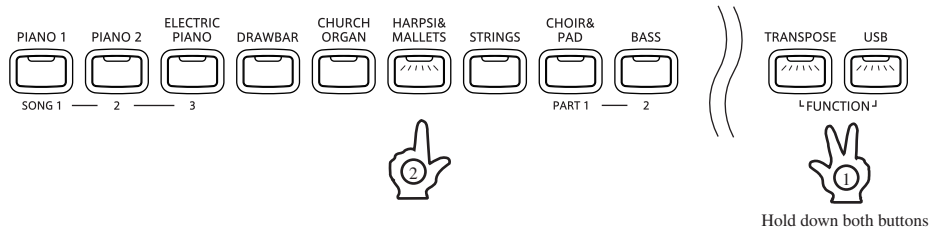

The display will alternate between showing 'tun' (Tuning) and a number representing the pitch for 'A' in Hz (Hertz).

□ Step 2

Press the ▲ or ▼ VALUE buttons to raise or lower the pitch.

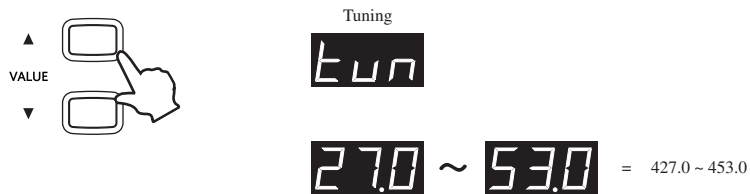

The pitch will increase or decrease by 0.5 Hz increments each time one of the VALUE buttons is pressed.

The range of adjustment is from 427.0 to 453.0 Hz (displayed as 27.0 – 53.0).

The factory default value is set to the modern standard A = 440.0 Hz (displayed as 40.0).

- When pressing a key while using tuning mode, the sound that was selected prior to entering tuning mode will be heard. To use a different sound while tuning, first exit the tuning mode, select the desired sound, then repeat 'Step 1' and 'Step 2' again.
- When the power is turned off, tuning settings will reset to the factory default value of 440.0 Hz (displayed as 40.0).

9) TEMPERAMENT

The CN33 digital piano offers immediate access to a variety of musical temperaments popular during the Renaissance and Baroque periods. It may prove interesting and educational to experiment with different temperaments, other than the modern 'equal temperament' standard this is dominant in music today.

BRIEF EXPLANATION OF TEMPERAMENTS

EQUAL TEMPERAMENT (PIANO ONLY)	This is the default temperament. If a piano sound is selected the tuning is stretched like an acoustic piano (EQUAL TEMPERAMENT). If any other type of sound is selected the tuning will be EQUAL (FLAT). An explanation of EQUAL TEMPERAMENT and EQUAL TEMPERAMENT (FLAT) is provided later in this section. If a piano sound is used in a layer with any other sound, then both sounds will use the EQUAL TEMPERAMENT (stretched) tuning.
MERSENNE PURE TEMPERAMENT (MAJOR) MERSENNE PURE TEMPERAMENT (MINOR)	This temperament, which eliminates dissonances for thirds and fifths, is still popular for choral music because of its perfect harmony. Performers must be aware which key they are playing in when using this temperament. Any key modulation will result in dissonances. When playing music in a particular key, the key of the temperament must also be correctly matched. When playing in a major key select Pure (Major) and when playing in a minor key select Pure (minor).
PYTHAGOREAN TEMPERAMENT	This temperament, which uses mathematical ratios to eliminate dissonance for fifths, is very limited for use with chords, but it produces very characteristic melodic lines.
MEANTONE TEMPERAMENT	This temperament, which uses a mean between a major and minor whole tone to eliminate dissonance for thirds, was devised to eliminate the lack of consonances experienced with certain fifths for the Mersenne pure temperament. It produces chords that are more beautiful than those with the equal temperament.
WERCKMEISTER III TEMPERAMENT KIRNBERGER III TEMPERAMENT	These two temperaments are placed in between Meantone and Pythagorean. For music with few accidentals, this temperament produces the beautiful chords of the mean tone, but as accidentals increase, the temperament produces the characteristic melodies of the Pythagorean temperament. It is used primarily for classical music written in the Baroque era to revive the original characteristics.
EQUAL TEMPERAMENT (FLAT)	This is an 'unstretched' equal temperament that divides the scale into twelve equal semitones. This produces the same chordal intervals in all twelve keys, and has the advantage of limitless modulation of the key. However the tonality of each key becomes less characteristic and no chord is in pure consonance.
EQUAL TEMPERAMENT	This is the most popular piano temperament. The hearing ability of a human is uneven and is not as accurate with high frequency and low frequency as it is with the middle range. This temperament's tuning is stretched to compensate for this so the sound will be heard naturally to the ears. This 'stretched' equal temperament is a practical variation of the 'unstretched' equal temperament which was invented on a mathematical basis.

Step 1

Press and hold the TRANSPOSE and USB buttons, then press the STRINGS button.

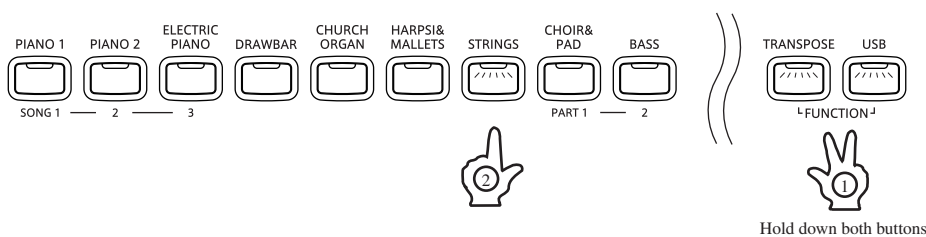

The display will alternate between showing 'tMP' (Temperament) and a symbol to indicate which type of temperament is in use.

□ Step 2

Press the ▲ or ▼ VALUE buttons to change the type of temperament.

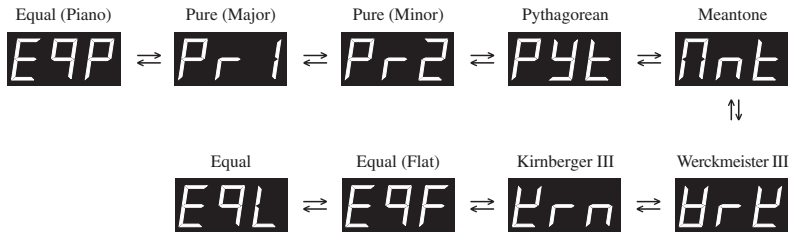
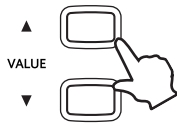

When the power is turned off, the temperament will reset to the factory default 'equal temperament (piano only)' type.

If a piano sound is selected when using the factory default 'equal temperament (piano only)' type, the tuning is stretched like an acoustic piano (EQUAL TEMPERAMENT). If any other type of sound is selected, the tuning will be EQUAL (FLAT).

- After selecting the desired temperament, please read the following section on selecting a key signature for the temperament before continuing.

◇ KEY SIGNATURE OF TEMPERAMENT

Limitless modulation of the key became available only after the invention of equal temperament. When using a temperament other than equal temperament, care must be taken to choose the key signature to play in. For example, if the song to be played is written in D major, 'D' would be chosen as the temperament key.

□ Step 1

Press one of the 88 piano keys to select the key signature of the temperament.

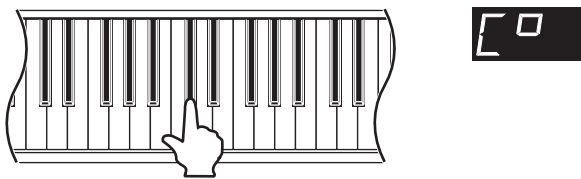

The note name of the key pressed will be shown in the display and chosen as the key of the temperament.

- Changing the key of the temperament will only change the 'balance' of the tuning, the pitch of the keyboard will remain unchanged. Use the TUNING or TRANSPOSE functions to change the pitch of the whole keyboard.
- The key of the temperament function will have no effect when equal temperament is selected.

C →		D# →		F# →		A →	
C# →		E →		G →		A# →	
D →		F →		G# →		B →	

◇ MIDI OVERVIEW

The term MIDI is an acronym for Musical Instrument Digital Interface, an international standard for connecting synthesizers, sequencers (MIDI recorders) and other electronic instruments so that they can exchange performance data.

The CN33 is equipped with two MIDI jacks for exchanging data: MIDI IN and MIDI OUT. Each uses a special cable with a DIN connector.

- MIDI IN : For receiving note, program change and other data.
- MIDI OUT : For sending note, program change and other data.

MIDI uses channels to exchange data back and forth between MIDI devices. There are receive (MIDI IN) and transmit (MIDI OUT) channels. Most musical instruments or devices with MIDI functions are equipped with both MIDI IN and OUT jacks and are capable of transmitting and receiving data via MIDI.

The receive channels are used to receive data from another MIDI device and the transmit channels are used to transmit data to another MIDI device.

■ Connection to an external sequencer

When connected as shown in the illustration below, songs played on the CN33 can be recorded using a MIDI recorder, with internal sounds (such as piano, harpsichord and vibraphone, etc.) controlled by the CN33's MULTITIMBRAL MODE function to create a multi-layer MIDI recording.

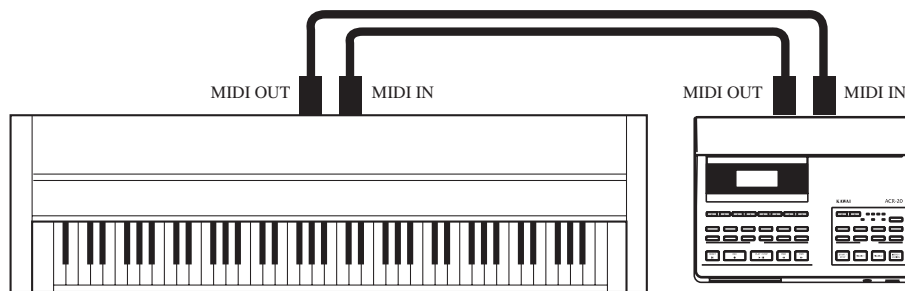

◇ CN33 MIDI functions

Transmit / receive keyboard note information	By transmitting MIDI data from the CN33 digital piano (MIDI OUT) a MIDI-connected keyboard can be played from the CN33 digital piano. Or alternatively, by receiving data (MIDI IN), the CN33 digital piano can be played from another MIDI-connected keyboard or device.
Transmit / receive channel setting	Specify transmit/receive channels within the range of 1 to 16.
Transmit / receive Program change (sound type) number	Transmit/receive program change data to/from a MIDI-connected musical instrument or device.
Transmit / receive pedal data	Transmit/receive sustain pedal and sustain pedal data from a MIDI-connected musical instrument or device. Sostenuto pedal data can also be transmitted.
Receive volume data	The CN33 digital piano will respond to MIDI volume data sent from a MIDI-connected musical instrument or device.
Multi-timbral setting	The CN33 digital piano is able to receive multiple channel MIDI data from a MIDI-connected musical instrument or device, when multi-timbral mode is turned on.
Transmit / receive exclusive data	Transmit/receive front panel or menu function settings as exclusive data.
Transmit recorder playback data	Songs recorded using the recorder can be played back from a MIDI-connected musical instrument or recorded by an external sequencer via the MIDI OUT jack.

Please refer to the 'MIDI implementation chart' (page 63) for further information regarding the CN33 digital piano's MIDI functions.

10) MIDI CHANNEL

This function is used to determine on which MIDI channel the CN33 digital piano will exchange MIDI information with external MIDI devices and instruments or a personal computer.

The selected channel will function as both the transmit and receive channel.

□ Step 1

Press and hold the TRANSPOSE and USB buttons, then press the CHOIR & PAD button.

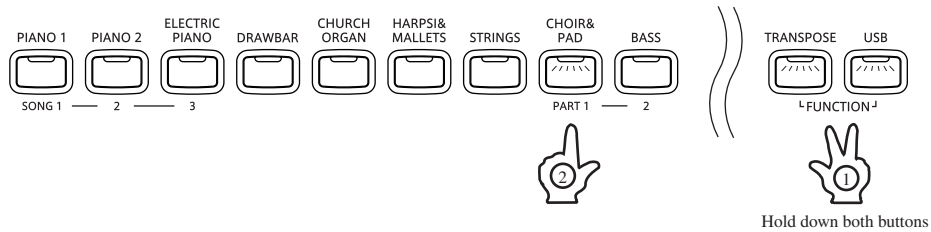

The display will alternate between showing 'Chn' (Channel) and the channel number. The default channel is 1.

□ Step 2

Press the ▲ or ▼ VALUE buttons to change the channel number.



The channel number can be set from 1 to 16.

- The CN33 digital piano's MIDI channel setting defaults to receiving MIDI channel information from all channels, 1 to 16. each time the power is turned on. This is called 'omni mode on'. The CN33 digital piano will switch to 'omni mode off' when a specific channel is selected using the MIDI channel function, and data will only be received on that specified channel. In order to specify channel 1 in the 'omni mode off' state, first select channel 2, then select channel 1.

11) TRANSMIT PROGRAM CHANGE ON/OFF

This function determines whether or not the CN33 digital piano will transmit program change information when pressing the SOUND SELECT buttons. When transmit program change is turned on, pressing the SOUND SELECT buttons will send the program change numbers as listed below.

Sound Button	Sound Name	Multi-Timbral mode			
		Off, On1	On2		
		Prog #	Bank MSB	Bank LSB	Prog #
PIANO 1	Concert Grand	1	121	0	1
	Studio Grand	2	121	1	1
	Mellow Grand	3	121	2	1
	Modern Piano	4	121	0	2
PIANO 2	Concert Grand 2	5	95	16	1
	Studio Grand 2	6	95	17	1
	Mellow Grand 2	7	95	18	1
	Rock Piano	8	121	1	2
ELECTRIC PIANO	Classic E.Piano	9	121	0	5
	Modern E.P.	10	121	0	6
	60's E.P.	11	121	3	5
	Modern E.P. 2	12	121	1	6
DRAWBAR	Jazz Organ	13	121	0	18
	Drawbar Organ	14	121	0	17
	Drawbar Organ 2	15	121	1	17
	Be 3	16	95	2	17
CHURCH ORGAN	Church Organ	17	121	0	20
	Diapason	18	95	7	20
	Full Ensemble	19	95	1	21
	Diapason Oct	20	95	6	20
HARPSI & MALLETS	Harpsichord	21	121	0	7
	Harpsichord 2	22	121	3	7
	Vibraphone	23	121	0	12
	Clavi	24	121	0	8
STRINGS	Slow Strings	25	95	1	45
	String Pad	26	95	8	49
	Warm Strings	27	95	1	49
	String Ensemble	28	121	0	49
CHOIR & PAD	Choir	29	121	0	53
	Choir 2	30	95	53	54
	New Age Pad	31	121	0	89
	Atmosphere	32	121	0	100
BASS	Wood Bass	33	121	0	33
	Finger Bass	34	121	0	34
	Fretless Bass	35	121	0	36
	W. Bass & Ride	36	95	1	33

In addition to the SOUND SELECT buttons, other button operations such as touch curve, dual, digital effects and reverb settings can be transmitted as MIDI exclusive data when the corresponding buttons are pushed. When set to off, no program change or other panel information will be transmitted via MIDI.

□ Step 1

Press and hold the TRANSPOSE and USB buttons, then press the BASS button.

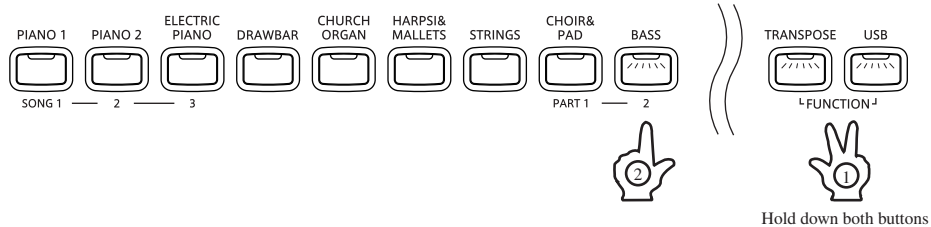

The display will alternate between showing 'PGM' (Program) and on/off status. The default is on.

□ Step 2

Press the ▲ or ▼ VALUE buttons to toggle transmit program change on and off.

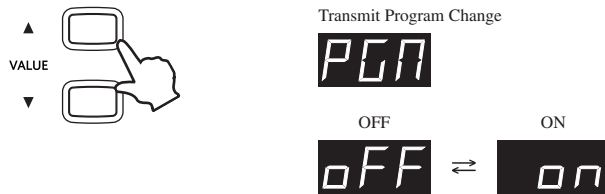

Program change numbers will also be transmitted when multi-timbral mode is on.

When using DUAL mode, on/off information and sound type settings are transmitted as exclusive data, but program change numbers will not be transmitted.

The CN33 digital piano's transmit program change setting defaults to 'ON' each time the power is turned on.

12) LOCAL CONTROL ON/OFF

This function determines whether the CN33 digital piano's sound will be played from the piano's keyboard ('ON') or only from an external MIDI instrument ('OFF'). Even with local control set to 'OFF' the piano's keyboard will still transmit to external MIDI devices and instruments or a personal computer.

□ Step 1

Press and hold the TRANSPOSE and USB buttons, then press the EFFECTS button.

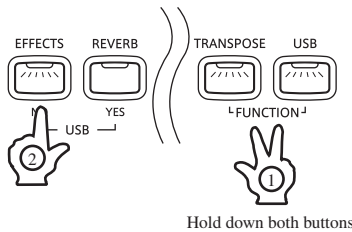

The display will alternate between showing 'LcL' (Local) and on/off status. The default is on.

□ Step 2

Press the ▲ or ▼ VALUE buttons to toggle local control on and off.

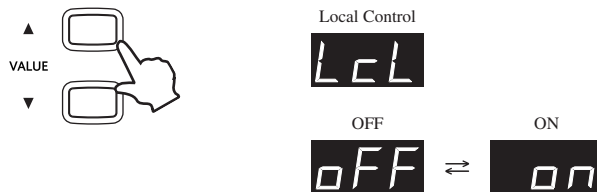

- When local control is set to 'OFF', there will be no sound heard when the keys are pressed.
- The CN33 digital piano's local control setting defaults to 'ON' each time the power is turned on.

13) MULTI-TIMBRAL MODE ON/OFF

This function allows the CN33 digital piano to receive data on more than one MIDI channel simultaneously. In this mode, the CN33 digital piano can play different musical parts with different sounds for each part.

With multi-timbral mode enabled, an external sequencer can be used to enjoy an ensemble performance playing multiple sound types (multi-timbral) on a single CN33 digital piano.

◆ Multi-Timbral On (On1 and On2)

This turns on the flexible 16 part multi-timbral capability. Individual MIDI channels can be turned on and off, and assigned any internal sound. The internal sound for each MIDI channel can be changed when the program change number for the desired sound is received from external MIDI device and instruments or a personal computer. The CN33 digital piano's normal program change numbers are assigned in On1 (Please see page 49 for a list of the program change numbers), and General MIDI program change numbers are assigned in On2.

◆ Multi-Timbral Off

This turns off the multi-timbral capability. Only one MIDI channel will be active and only the sound currently selected will be heard when a MIDI signal is received.

□ Step 1

Press and hold the TRANSPOSE and USB buttons, then press the REVERB button.

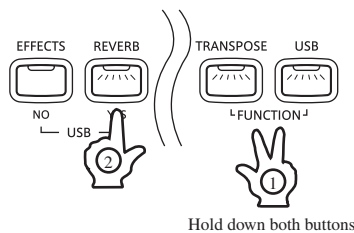

Hold down both buttons

The display will alternate between showing 'MLt' (Multi) and on/off status. The default is off.

□ Step 2

Press the ▲ or ▼ VALUE buttons to toggle multi-timbral on1, on2 and off.

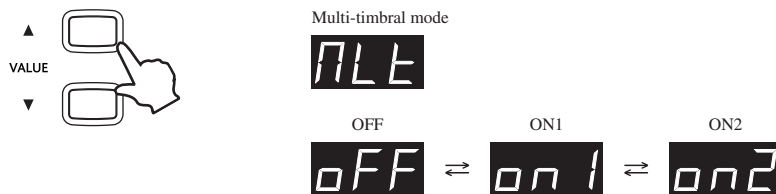

When the multi-timbral mode is OFF and MIDI information is received, only the currently selected internal sound will be heard.

When the multi timbral mode is ON, the internal sound that is heard corresponds to any program change number that was received from external MIDI devices and instruments or a personal computer. This sound may be different from the internal sound that is currently selected using the SOUND SELECT buttons on the panel.

When multi-timbral mode is ON, the ON/OFF setting for each individual MIDI receive channel can also be set (See page 55).

- The CN33 digital piano's multi-timbral mode defaults to 'OFF' each time the power is turned on.

14) CHANNEL MUTE

This function determines which MIDI channels are activated to receive MIDI information when multi-timbral mode is set to ON. Each of the 16 channels can be individually activated or deactivated.

□ Step 1

Press and hold the TRANSPOSE and USB buttons, then press the SPLIT button.

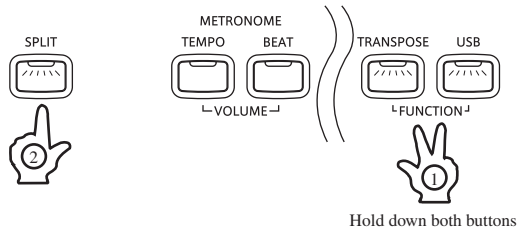

The display will alternate between showing 'P01' (Play 01) and 'On', indicating that the channel 1 is activated.

■ When multi-timbral mode is set to OFF, the 'channel mute' function can not be selected.

□ Step 2

Press the ▲ or ▼ VALUE buttons to toggle channel mute on and off.

To turn the other channels on and off, use the 16 left-most white keys to select a desired channel. The display will change to indicating the selected channel. Then use the value buttons to toggle channel mute on and off.

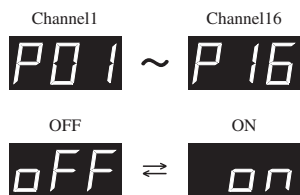
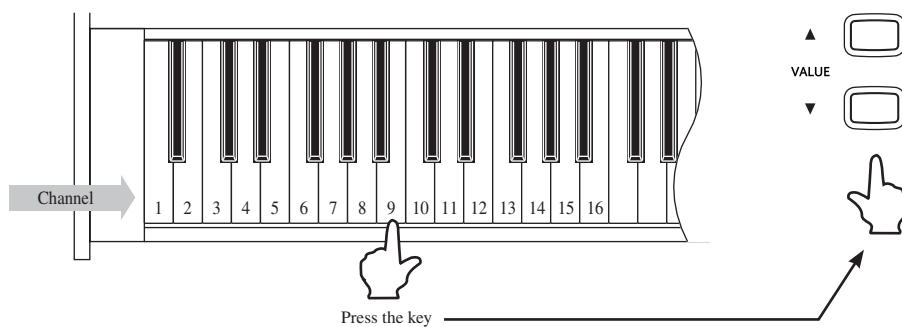

- When changing the channel mute settings, no sound will be heard when the keys are pressed to select the individual channels.
- When the multi-timbral mode is first turned ON after the power has been turned on, all MIDI receive channels 1-16 will be set to 'ON'. This is the default setting.

15) SEND PROGRAM CHANGE NUMBERS

This function allows the CN33 digital piano to send program change numbers beyond the 32 pre-defined numbers transmitted by the SOUND SELECT buttons. Using this function, any number from 1 to 128 can be sent.

□ Step 1

Press and hold the TRANSPOSE and USB buttons, then press the TEMPO button.

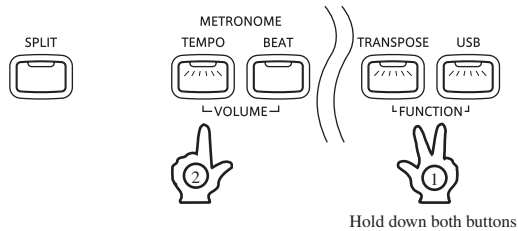

The display will alternate between showing 'PG#' (Program #) and a program change number.

□ Step 2

Press the ▲ or ▼ VALUE buttons to change the program change number.



□ Step 3

Press both ▲ and ▼ VALUE buttons simultaneously to send the program change number.



16) USER MEMORY

This function allows the CN33 digital piano to save the user-definable settings when the power is turned off. Once written to the memory, the saved settings will be recalled every time the power is turned on.

The following settings can be saved.

- ◆ Sound type including starting sound and primary sound for each category.
- ◆ Effects/Reverb settings
- ◆ Menu function settings
- ◆ Touch
- ◆ Transpose
- ◆ Tempo, beat, and sound volume of the metronome

□ Step 1

Press and hold the TRANSPOSE and USB buttons, then press the BEAT button.

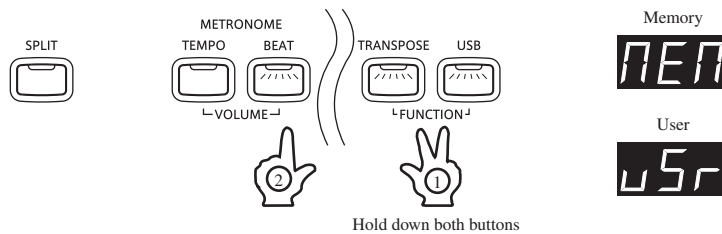

The display will alternate between showing 'MEM' (Memory) and 'uSr' (User).

□ Step 2

Press the REC button to execute the save operation.

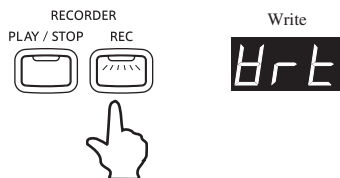

The save operation is completed when the display shows 'Wrt' (Write).

□ Step 3

When finished, press any one of the SOUND SELECT buttons to exit the menu.

17) FACTORY RESET

This function will appear only when the user memory function has been used.

This function resets the CN33 digital piano to the factory settings.

All parameters you saved in 'User Memory' will be reset to the factory preset values.

□ Step 1

Press and hold the TRANSPOSE and USB buttons, then press the Play /STOP button.

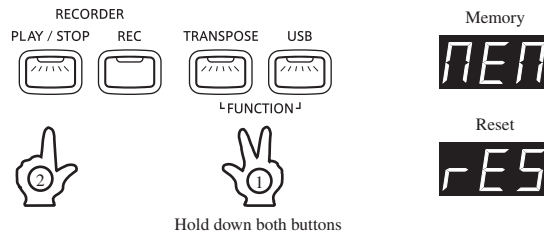

The display will alternate between showing 'MEM' (Memory) and 'RES' (Reset).

□ Step 2

Press the REC button to restore factory settings, and exit the menu.

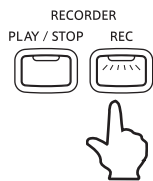

8. APPENDICES

◇ CONNECTING TO OTHER DEVICES

⚠ Caution • Do not directly connect the LINE IN and LINE OUT jacks of the CN33 together with a cable. An audio loop (oscillation sound) will occur, resulting in damage to the unit.

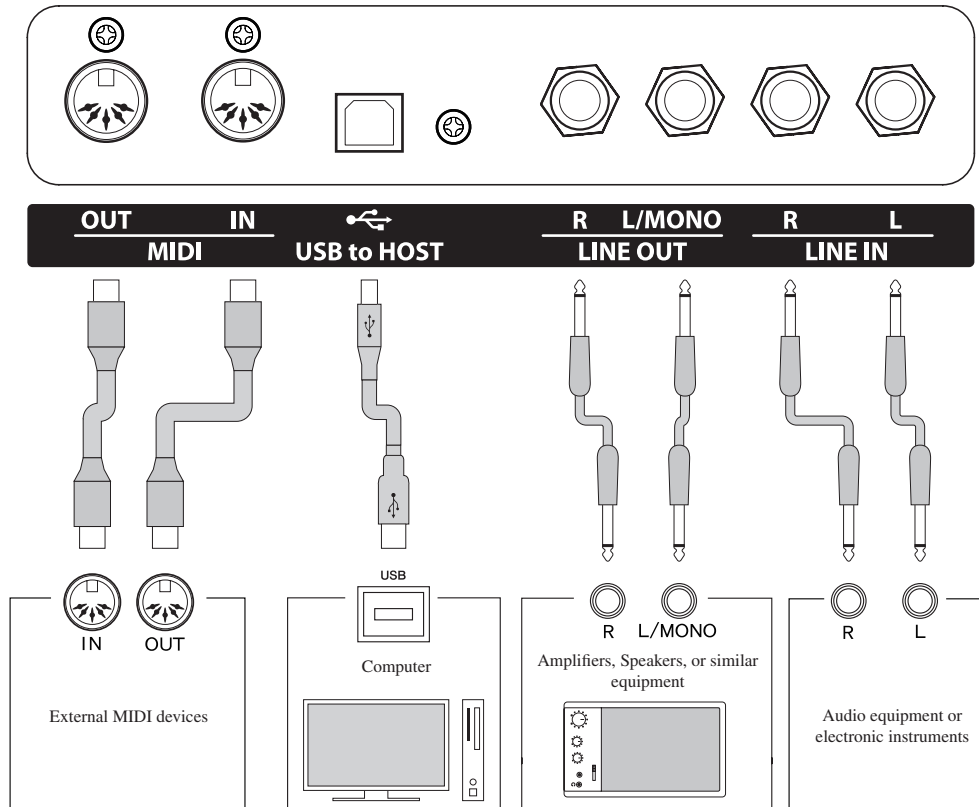

① MIDI JACKS

These jacks are used to connect external MIDI devices with the CN33 digital piano.

There are two terminals: MIDI IN and MIDI OUT.

② USB JACK

This jack is used to connect with a personal computer and exchange MIDI data.

When the CN33 digital piano is connected to a computer via a commercially available USB cable, the CN33 digital piano will be recognized as a MIDI device.

As with a regular MIDI interface, the CN33 digital piano will be able to transmit and receive MIDI messages.

There are A USB port and B USB port. Connect a computer to the A port and digital piano to the B port.

③ LINE OUT JACKS

These jacks provide stereo output of the piano's sound to amplifiers, tape recorders or similar equipment.

The audio signal coming through the LINE IN jacks is also routed to these jacks. The piano's sound is mixed with the LINE IN signals.

The CN33 digital piano's MASTER VOLUME slider can control the output level of its own sound while it does not control the LINE IN signal.

④ LINE IN JACKS

These jacks are used to connect a pair of stereo outputs from other audio equipment or electronic instruments to the piano's speakers.

The audio signal coming through these jacks bypasses the piano's volume control. To adjust the volume level, use the output control of the external device.

◇ USB MIDI

The CN33 digital piano features a 'USB to Host' type connector, allowing the instrument to be connected to a computer and utilised as a MIDI device. Depending on the type of computer and operating system installed, additional driver software may be required for USB MIDI communication to function correctly.

Operating System	USB MIDI Driver Support
Windows ME Windows XP (no SP, SP1, SP2, SP3) Windows XP 64-bit Windows Vista (SP1, SP2) Windows Vista 64-bit (SP1, SP2) Windows 7 Windows 7 64-bit	No additional USB MIDI driver software required. The standard (built-in) Windows USB MIDI driver will be installed automatically when the instrument is connected to the computer. After driver installation, ensure that the 'USB Audio Device' (Windows ME/Windows XP) or 'USB-MIDI' (Windows Vista/Windows 7) device is correctly selected in the application software.
Windows 98 SE Windows 2000 Windows Vista (no SP)	Additional USB MIDI driver software required. Please download the USB MIDI driver from the KAWAI website: ▶ http://www.kawai.co.jp/english After driver installation, ensure that the 'KAWAI USB MIDI' device is correctly selected in the application software.
Windows Vista 64-bit (no SP)	USB MIDI is not supported. Please upgrade to service pack 1 or service pack 2.
Mac OS X	No additional USB MIDI driver software required. The standard (built-in) Mac OS X USB MIDI driver will be installed automatically when the instrument is connected to the computer.
Mac OS 9	USB MIDI is not supported. Please use the standard MIDI IN/OUT connectors.

USB MIDI INFORMATION

- If the instrument's MIDI IN/OUT jacks and USB MIDI port are both connected simultaneously, the USB MIDI port will be given priority.
- Ensure that the instrument is turned off before attempting to connect the USB MIDI cable.
- When connecting the instrument to a computer using the USB MIDI port, there may be a short delay before communications begin.
- If the instrument is connected to a computer via a USB hub and USB MIDI communication becomes unreliable/unstable, please connect the USB MIDI cable directly to the one of the computer's USB ports.
- Disconnecting the USB MIDI cable suddenly, or turning the instrument on/off while using USB MIDI may cause computer instability in the following situations:
 - while installing the USB MIDI driver
 - while starting up the computer
 - while MIDI applications are performing tasks
 - while the computer is in energy saver mode
- If there are any further problems experienced with USB MIDI communication while the instrument is connected, please double-check all connections and relevant MIDI settings in the computer's operating system.

* 'MIDI' is a registered trademark of the Association of Manufacturers of Electronic Instruments (AMEI).

* 'Windows' is a registered trademark of Microsoft Corporation.

* 'Mac' and 'Mac OS' are registered trademarks of Apple Inc.

* Other company names and product names mentioned referenced herein may be registered trademarks or trademarks of respective owners.

◆ ASSEMBLY INSTRUCTIONS

- ⚠ Caution**
- Ensure that this instruction manual is read thoroughly before attempting to assemble the CN33 digital piano, and that two or more people work on assembly.
 - It may be necessary to tilt the unit by 90 degrees while assembling the CN33 digital piano. During this time, ensure that hands are not caught in the piano, keyboard lid, or score stand, and that the piano is not dropped on an individual's feet.

■ PARTS PROVIDED

Before attempting to assemble the CN33 digital piano unit, ensure that all parts are included. A Phillips-head screwdriver will also be required to assemble the unit (not included).

- (A) Piano (x 1)
- (B) Pedal board (x 1)
- (C) End panel (x 1 each for left and right)
- (D) Back panel (x 1)
- (E) Adjuster bolt (x 1)
- (F) Screw: $\phi 4 \times 16$ (x 4) (Silver)
- (G) Screw: $\phi 4 \times 20$ (x 4)
- (H) Screw: $\phi 4 \times 30$ (x 4)
- (I) Screw: M6 x 25 (x 4)
- (J) Cord clamp (x 2)
- (K) Headphone hook and screws (x 1 set)
- (L) Power cord (x 1)

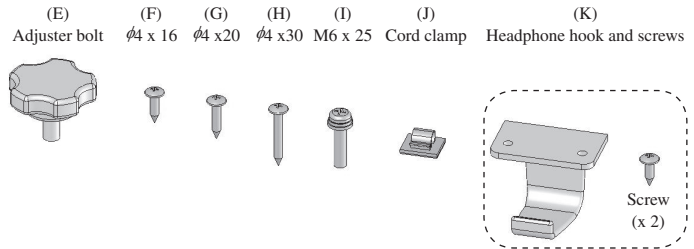

■ ASSEMBLY SEQUENCE

- ⚠ Caution**
- Be careful not to scratch or damage the floor, piano, or stand at the time of assembly.

1. Screw the adjuster bolt (E) into the threaded screw hole provided in the base of the pedal board.
2. Attach the pedal board (B) and end panels (C), sliding the front of the pedal board into the notch in the end panels. Ensure the metal bracket on the base of the end panel slides beneath the pre-attached screw in the pedal board.
3. Hold the pedal board (B) and end panels (C) together, then tighten the pre-attached screws on the left and right sides. Attach two additional screws (F) on each side, ensuring all screws are fastened tightly and that there are no large gaps between the assembled parts.
4. Unfasten and extend the pedal connection cable attached to the bottom of the pedal board.
5. Attach the back panel (D) to the stand assembly using screws (G) and (H) in the prepared holes. Loosely tighten the screws with the * symbol.

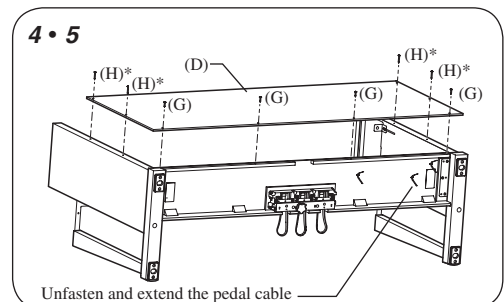
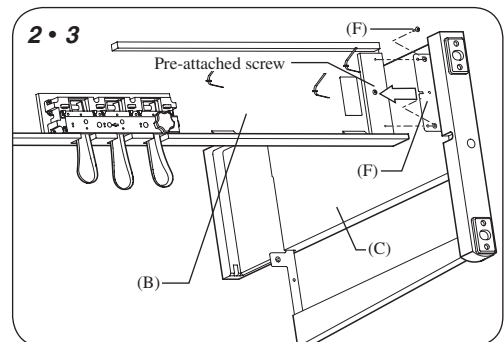
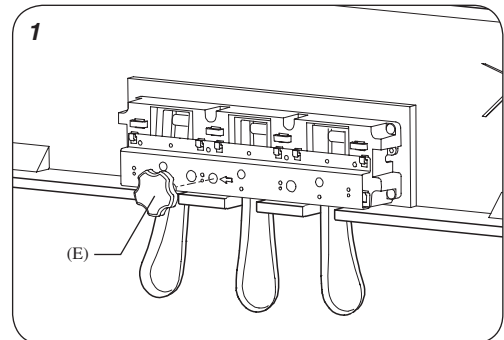

6. Place the stand upright so that the backside of the stand assembly rests against a wall, then slowly and carefully insert the piano. Ensure that more than two people work on the assembly. If attempting to insert the piano without resting the stand against a wall, support the back of the stand using your foot or leg to prevent the stand from sliding backwards.

⚠ Caution • Ensure that the piano is not dropped on an individual's feet, and that fingers, hands and feet are not caught in the piano.

7. Fasten the piano (A) to the stand with four screws (I).

⚠ Caution • Ensure that the piano and the stand are securely fastened together with the correct screws to prevent the possibility of the piano falling.

8. Fix the headphone hook and screws (K) if desired.

9. Tightly fasten the screws (H) (with the * symbol in step 5).

10. Insert the connector of the pedal cord into the receptacle, and fix the cord with the cord clamp (J).

11. Turn the adjuster bolt (E) at the bottom of the pedal stand until the bolt firmly touches the floor, supporting the pedal board.

⚠ Caution • Ensure that the adjuster bolt (E) firmly touches the floor, supporting the pedal board and preventing damage.
When moving the piano, shorten the adjuster bolt (E) and readjust after moving has been completed.

12. Connect the power cable (K) to the AC IN terminal on the base of the main body, then pass the cable through the back board aperture, and out to the rear of the instrument.

13. Remove the protective film from the display.

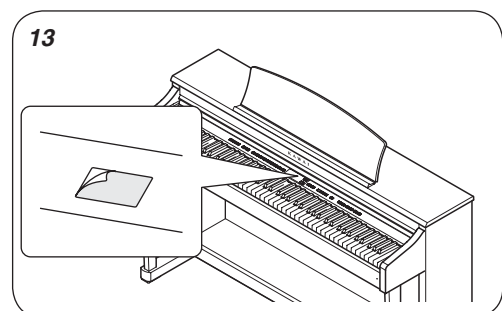
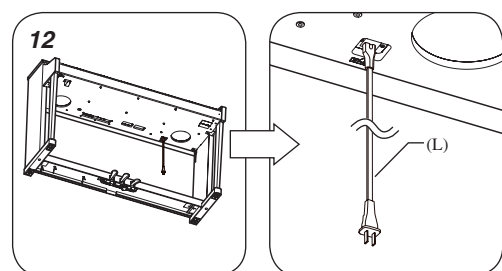
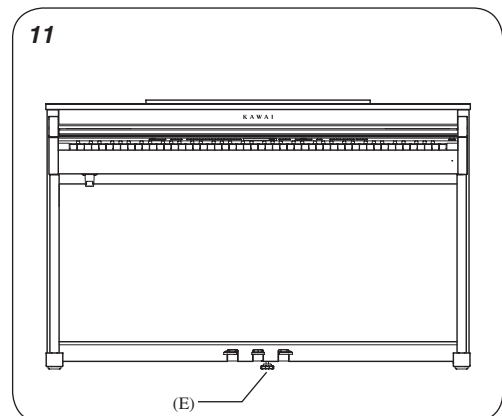
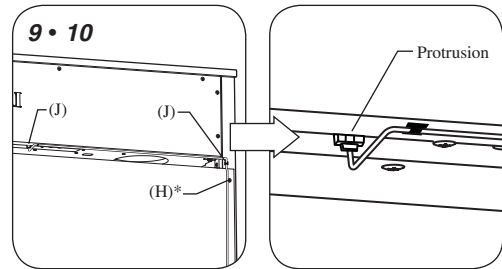
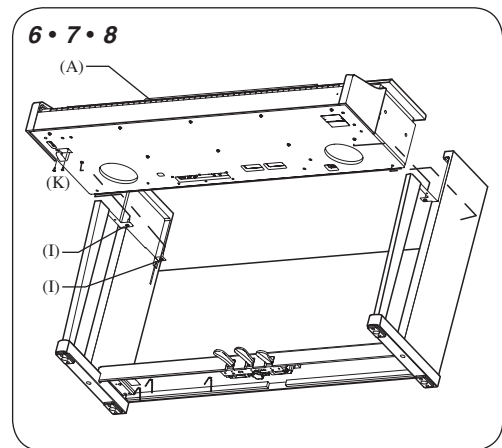

◇ SPECIFICATIONS

■ Keyboard	88 keys, Responsive Hammer Action with Ivory Touch and Let-Off
■ Polyphony	Max. 96 notes
■ Number of Sound	36
■ Sound Categories	Piano 1, Piano 2, Electric Piano, Drawbar, Church Organ, Harpsi & Mallets, Strings, Choir & Pad, Bass
■ Effects	Reverb (Room1/2, Stage, Hall1/2), Chorus, Tremolo, Delay (1/2/3), Rotary (1/2)
■ Temperaments	Equal (Piano Only), Mersenne pure (Major), Mersenne pure (minor), Pythagorea, Meantone, Werckmeister III, Kirnberger III, Equal (flat), Equal
■ Other Features	Demo (30 Preset Songs), Concert Magic (88 Preset Songs), Volume, Dual, Split, Four Hands, Balance Slider, Transpose, Tune, Lower Octave Shift, Lower Pedal On/Off, Touch Curve (Light 1, Light 2, Normal, Heavy 1, Heavy 2, Off), MIDI (16 part multi-timbral capability), Damper Hold, Damper Effect, String Resonance, User Memory, Factory Reset
■ Lesson Function	Right/left part balance adjustable, tempo adjustable. * Please refer to the separate 'Concert Magic & Lesson Song Lists' booklet for a complete listing of available lesson songs.
■ Recorder	2 tracks, 3 songs - total memory capacity approximately 15,000 notes.
■ Metronome	Time signatures: 1/4, 2/4, 3/4, 4/4, 5/4, 3/8, 6/8 Tempo: 10-400 BPM
■ USB Functions	SMF song player, Save user Song, Load user Song, Delete, Format
■ Pedals	Damper (half-peddalling supported), Soft, Sostenuto
■ Jacks	Headphones x 2, LINE IN (L, R), LINE OUT (L/MONO, R), MIDI (IN, OUT), USB to Host, USB to Device
■ Output Power	20 W x 2
■ Speakers	16 cm x 2
■ Key Cover	Sliding type
■ Power Consumption	45 W
■ Dimensions	1380 (W) x 470 (D) x 880 (H) mm (with music rack flattened)
■ Weight	54 kg

◇ MIDI EXCLUSIVE DATA FORMAT

1st byte	2nd byte	3rd byte	4th byte	5th byte	6th byte	7th byte	8th byte	9th byte	10th byte
1	2	3	4	5	6	7	8	9	10

- 1 F0 Start code
- 2 40..... KAWAI's ID number
- 3 00 - 0F MIDI channel
- 4 10, 30..... Function code (30 when setting MULTI TIMBRE ON/OFF)
- 5 04..... Indicates that the instrument is Electronic Piano
- 6 02..... Indicates that the piano is one of 'CA' or 'CN' series
- 7 data 1
- 8 data 2..... (See the table below.)
- 9 data 3
- 10 F7 End code

data 1	data 2	data 3	Function
00	00	—	Multi Timbre Off
00	01	—	Multi Timbre On 1
00	02	—	Multi Timbre On 2
0D	00-07	—	00: Effect Off, 01: Chorus, 02: Delay 1, 03: Delay 2, 04: Delay 3, 05: Tremolo, 06: Rotary 1, 07: Rotary 2
0E	00-03, 06, 07	—	00: Reverb Off, 01: Room 2, 02: Stage, 03: Hall 1, 06: Room 1, 07: Hall 2
14	00-7F	—	Dual/Split balance
16	1F-60	—	Tune, 40: 440 Hz
17	00, 7F	—	00: Program Change Off, 7F: Program Change On
18	00-05	—	00: Light 1, 01: Normal, 02: Heavy 1, 03: Off, 04: Light 2, 05: Heavy 2
19	00-03	—	Lower Octave Shift
20	00-23	00-23	Dual, data 2: Main sound, data 3: Layer sound
21	00-23	00-23	Split, data 2: Upper sound, data 3: Lower sound
22	00-23	00-23	Four Hands, data 2: Right sound, data 3: Left sound
25	00-08	00-0B	data 2: Temperament, data 3: Key
26	00, 7F	00-0F	Multi Timbre, data 2: 00 (On), 7F (Off), data 3: channel

◇ MIDI IMPLEMENTATION CHART

KAWAI DIGITATL PIANO
MODEL : CN33

Date : November 2008
Version : 1.0

Function		Transmit	Receive	Remarks
Basic channel	Default Changes	1 1 - 16	1 1 - 16	
Mode	Default Messages Altered	3 × *****	1 1, 3* ×	* The default for the OMNI mode is ON. Specifying MIDI channels automatically turns it OFF.
Note number	True voice	9 - 120** *****	0 - 127 0 - 127	** The value depends on the Transpose setting.
Velocity	Note ON Note OFF	○ 9nH v=1-127 × 9nH v=0	○ ×	
After touch	Key's Channel's	× ×	× ×	
Pitch bend		×	×	
Control change	0,32 7 11 64 66 67	○ × × ○ (Right pedal) ○ (Center pedal) ○ (Left pedal)	○ ○ ○ ○ ○ ○	Bank select Volume Expression pedal Sustain pedal Sostenuto pedal Soft pedal
Program change	True #	○ 0 - 127 *****	○***	*** See the Program Change Number Mapping in page 51.
System exclusive		○	○	On/Off Selectable
Common	Song Position Song Select Tune	× × ×	× × ×	
System Real time	Clock Commands	× ×	× ×	
Aux	Local On/Off All notes Off Active Sense Reset	× × ○ ×	○ ○ (123 - 127) ○ ×	
Notes				

Mode 1: omni mode On, Poly, Mode 2: omni mode On, Mono
Mode 3: omni mode Off, Poly, Mode 4: omni mode Off, Mono

○: Yes
×: No

KAWAI

THE FUTURE OF THE PIANO

CN33 Owner's Manual
KPSZ-0324 : 816781
OW1036E-I1001
Version 1
Printed in Indonesia

Copyright © 2010 KAWAI Musical Instruments Mfg. Co.,Ltd. All Rights Reserved.

Free Manuals Download Website

<http://myh66.com>

<http://usermanuals.us>

<http://www.somanuals.com>

<http://www.4manuals.cc>

<http://www.manual-lib.com>

<http://www.404manual.com>

<http://www.luxmanual.com>

<http://aubethermostatmanual.com>

Golf course search by state

<http://golfingnear.com>

Email search by domain

<http://emailbydomain.com>

Auto manuals search

<http://auto.somanuals.com>

TV manuals search

<http://tv.somanuals.com>