

KAWAI

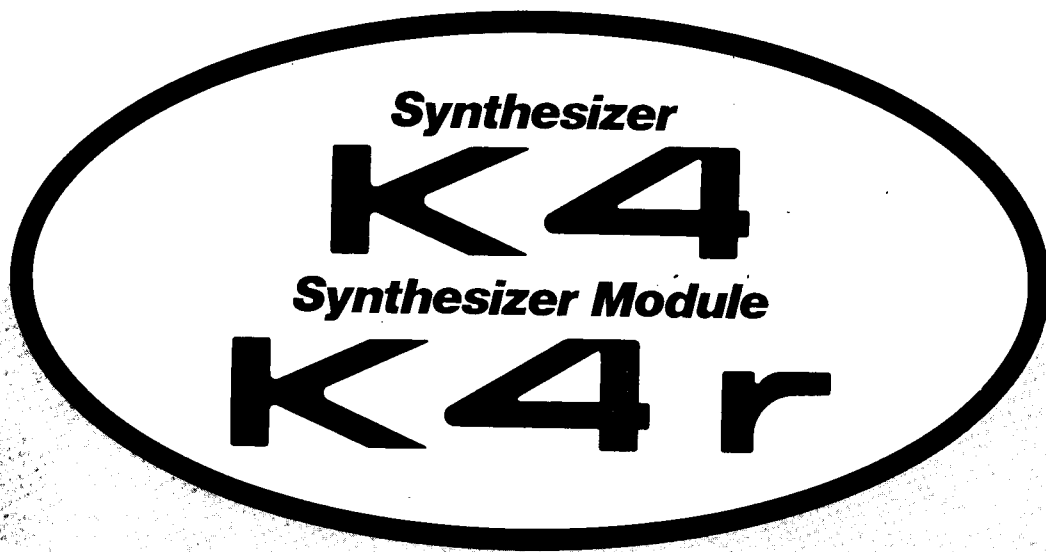

Owner's Manual

INTRODUCTION

Thank you for purchasing the Kawai K4/K4r synthesizer. This revolutionary new synthesizer uses 16-bit sampled and synthesized waveforms for optimum sound quality. The friendly user-interface and parameter structure of the Kawai K series has been retained, and new functions and features added to increase the K4/K4r's music making power.

Please read this manual thoroughly before using the K4/K4r. It has been written to allow you to get the most out of the instrument's capabilities with the least amount of effort.

■ K4 PANEL LAYOUT

[FRONT VIEW]

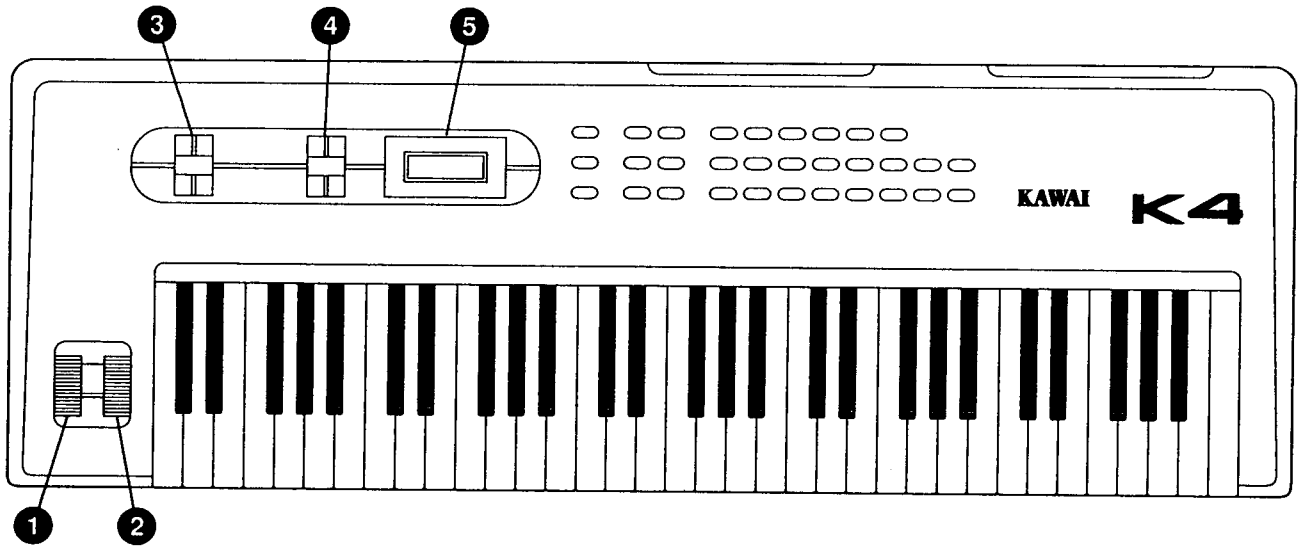

[REAR VIEW]

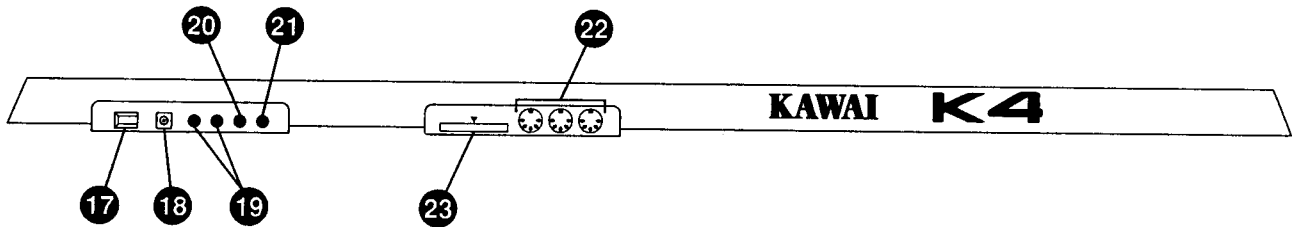

[CONTROL SWITCHES]

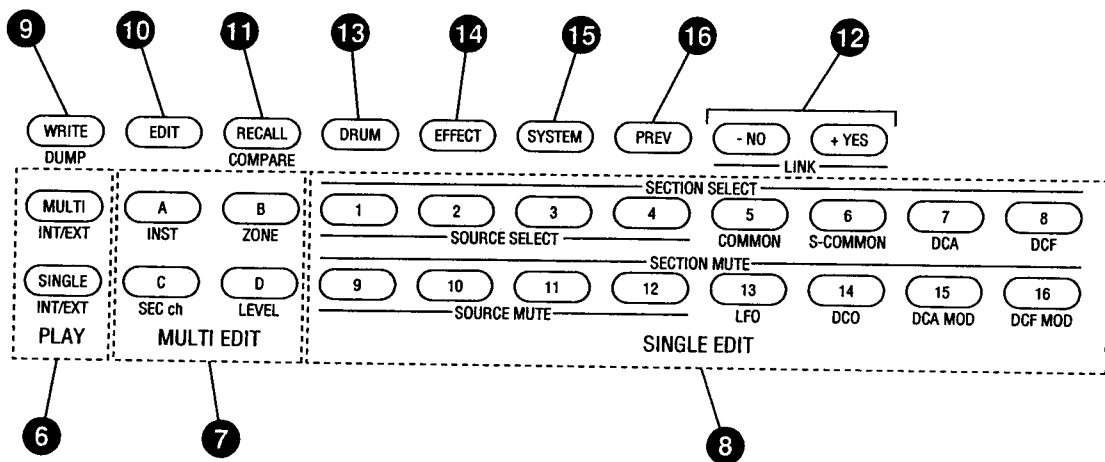

Contents of Panel Nomenclature

■ PLAY Mode

- MULTI** : Select Internal or Card MULTI Patch (P. 12)
- INT/EXT** : Select Internal or Card SINGLE Patch (P. 11)
- SINGLE** : Select Internal or Card SINGLE Patch (P. 11)
- INT/EXT** : Select Internal or Card SINGLE Patch (P. 11)
- NO** / **+ YES** : Select and Set LINK Play (P. 15)
- LINK** : Select and Set LINK Play (P. 15)
- PLAY** : Return to PLAY mode

■ SINGLE EDIT Mode

- EDIT** : Enter EDIT mode (P. 28–33)
- NO** / **+ YES** : Select Value (P. 28)
- PREV** : Return to Previous Parameter (P. 28)
- RECALL** : Compare with Sound before Editing (P. 28)
- COMPARE** : Compare with Sound before Editing (P. 28)
- WRITE** : Perform WRITE, followed by SAVE and LOAD (P. 26)
- 1** / **2** / **3** / **4** : Select EDIT Source (P. 32)
- 9** / **10** / **11** / **12** : Select Source Mute (P. 32)
- 5** : Select Source mode, Pressure, Wheel, etc. (P. 34)
- COMMON** : Select Source mode, Pressure, Wheel, etc. (P. 34)
- 6** : Select Velocity, KS (Keyboard Scaling) Curve, etc. (P. 43)
- S-COMMON** : Select Velocity, KS (Keyboard Scaling) Curve, etc. (P. 43)
- 7** : Set Volume Envelope (P. 48)
- DCA** : Select Cutoff, Resonance, etc. (P. 52)
- 8** : Select Cutoff, Resonance, etc. (P. 52)
- DCF** : Change Tuning and Tone with LFO (P. 40)
- 13** : Change Tuning and Tone with LFO (P. 40)
- LFO** : Change Tuning and Tone with LFO (P. 40)
- 14** : Set Waveform and Pitch (P. 46)
- DCO** : Set Waveform and Pitch (P. 46)
- 15** : Control Volume with Velocity and KS (P. 49)
- DCA MOD** : Control Volume with Velocity and KS (P. 49)
- 16** : Change Tone in real time (P. 54)
- DCF MOD** : Change Tone in real time (P. 54)
- PLAY** : Return to PLAY mode

■ MULTI EDIT Mode

- SECTION SELECT** : Set Instrument (SINGLE) to be edited (P. 60)
- SECTION MUTE** : Set MULTI Section Mute (P. 60)
- A** : Set MULTI Instrument (SINGLE) (P. 61)
- INST** : Set MULTI Instrument (SINGLE) (P. 61)
- B** : Set Play Range (P. 62)
- ZONE** : Set Play Range (P. 62)
- C** : Set MIDI Channels for MULTI Sections (P. 63)
- SEC ch** : Set MIDI Channels for MULTI Sections (P. 63)
- D** : Set Instrument Level and Output Destination (P. 64)
- LEVEL** : Set Instrument Level and Output Destination (P. 64)
- PLAY** : Return to PLAY mode

■ Other EDIT Modes

- DRUM** : Set DRUM Section, Manual Drums (P. 66)
- EFFECT** : Set EFFECT (K4 only) (P. 24, 71)
- OUTPUT** : Set Panpot or Individual Output (K4r only) (P. 24, 71)
- SYSTEM** : Set Tuning and MIDI (P. 77)
- WRITE** : Set MIDI Data Dump contents and Execute Dump (P. 82, 88)
- DUMP** : Set MIDI Data Dump contents and Execute Dump (P. 82, 88)
- PLAY** : Return to PLAY mode



■ K4/K4r Synthesizer Owner's Manual Contents

Features	2
Names of Parts	5
Contents	6
How to use this Manual	8
Chapter 1.: Introduction.....	9
1-1. Instrument Setup	10
1. Making Connections.....	10
1-2. Let's Play!	11
1. Selecting a PLAY Mode (SINGLE or MULTI)	11
2. Possibilities of MULTI PLAY Mode	13
3. Tuning and Transposing	14
4. LINK Play	15
5. DRUM Play	16
6. Play Using a Computer or Sequencer	17
1-3. The Fundamentals of MIDI.....	18
Chapter 2.: Applications	23
2-1. K4/K4r Structure of Patches	24
2-2. The Tone Editing Process.....	25
2-3. Saving and Loading Data	26
2-4. Before Entering EDIT Mode	28
2-5. Editing a SINGLE Patch	29
1. SINGLE Patch Configuration	29
2. SINGLE Patch Parameters.....	33
EDIT Group	33
COMMON Group	34
AUTO BEND.....	37
LFO Group	40
S-COMMON (Source COMMON) Group.....	43
VEL (Velocity) Curve	44
KS (Keyboard Scaling) Curve.....	45
DCO Group.....	46
DCA Group.....	48
DCA MOD(DCA Modulation) Group	49
DCF Group	52
DCF MOD (DCF Modulation) Group.....	54
Editing Capabilities	57
Writing a SINGLE Patch	58

■ K4/K4r Synthesizer Owner's Manual Contents

2-6. Editing a MULTI Patch	60
1. MULTI Patch Configuration	60
2. Using MULTI Patches	60
3. Choosing a Section to Edit	60
4. Editing Section Parameters	61
EDIT Group	61
INST Group	61
ZONE Group	62
SEC ch (Section Channel) Group	63
LEVEL Group	64
Writing MULTI Patches	65
2-7. Editing Sounds for the DRUM Section	66
1. DRUM Section Configuration	66
2. Creating the DRUM Section Tones	68
3. Writing the DRUM Section	70
2-8. EFFECT (K4) and OUTPUT (K4r) Settings	71
1. EFFECT Patches (K4 only)	71
2. OUTPUT Patches (K4r only)	71
3. Programming Parameters	72
4. Explanation of Effect Types (K4 only)	74
5. Writing EFFECT and OUTPUT Settings	76
2-9. SYSTEM Programming	77
SYS (SYSTEM) Group	77
TRS (Transmit) Group	78
RCV (Receive) Group	79
Chapter 3: Advanced Applications	81
3-1. MIDI DATA DUMP	82
3-2. Play Using a Sequencer or Computer	83
3-3. MULTI Real Time Play	85
3-4. MIDI for the Advanced User	88
Appendices	90
1. Error Messages	90
2. Troubleshooting	91
3. Parameter Reference Chart	91
4. DRUM Section and EFFECT Factory Settings	92
5. Blank Chart	92
MIDI Implementation Chart	95
INDEX	96
Specifications	99

■ How to use this manual

This manual is composed of three chapters and appendices as shown below.

Chapter 1.: Introduction

- Instrument Setup
- Let's Play!
- The Fundamentals of MIDI

Chapter 2.: Applications

- K4/K4r Structure of Patches
- The Tone Editing Process
- Saving and Loading Data
- Before Entering EDIT Mode: The Basics of Editing
- Editing a SINGLE Patch
- Editing a MULTI Patch
- Editing Sounds for the DRUM Section
- EFFECT (K4) and OUTPUT (K4r) Settings
- SYSTEM Programming

Chapter 3.: Advanced Applications

- MIDI DATA DUMP
- Play Using a Sequencer or Computer
- MULTI Real Time Play
- MIDI for the Advanced User

Appendices

- Error Messages
- Troubleshooting
- Parameter Reference Chart
- DRUM Section and EFFECT Factory Settings
- Blank Chart
- MIDI Implementation Chart

Index

Specifications

Page 6' explains the basic function of each panel switch and the page number for more detailed information. This page pulls out and can be seen while reading other pages.

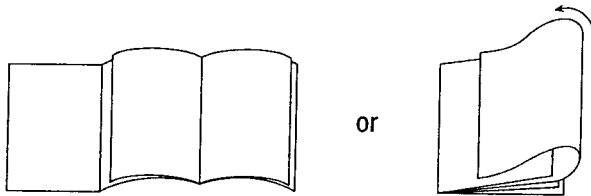

A section heading appears on the left or right side of each page, which makes it easy to locate a particular section of the manual. In addition, the primary subject covered on each page is shown in the upper right corner.

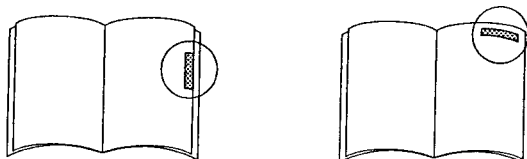

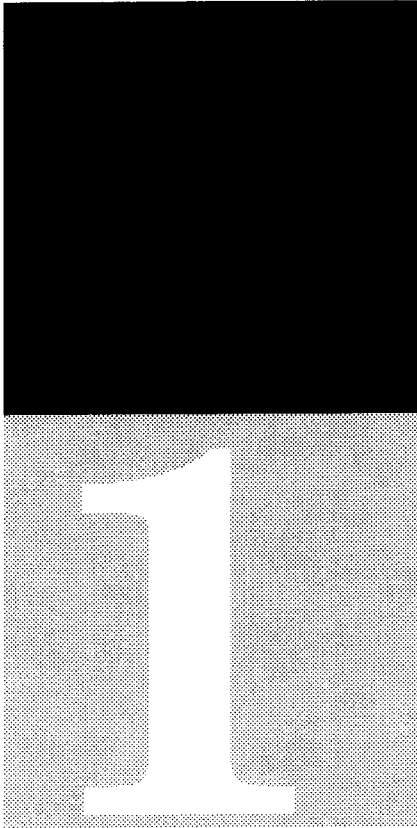

Chapter 1. Introduction

This chapter explains how to set up the K4/K4r and the functions available when playing.

1-1. Instrument Setup

1. Making Connections

1-2. Let's Play!

1. Selecting a PLAY mode (SINGLE or MULTI)
2. Possibilities of MULTI PLAY Mode
3. Tuning and Transposing
4. LINK Play
5. DRUM Play
6. Play Using a Computer or Sequencer

1-3. The Fundamentals of MIDI

1-1. Instrument Setup

1. Making Connections:

How to set the unit up quickly and easily

- (1) Connect the power adapter and keyboard amp. (or headphones) as shown in below.

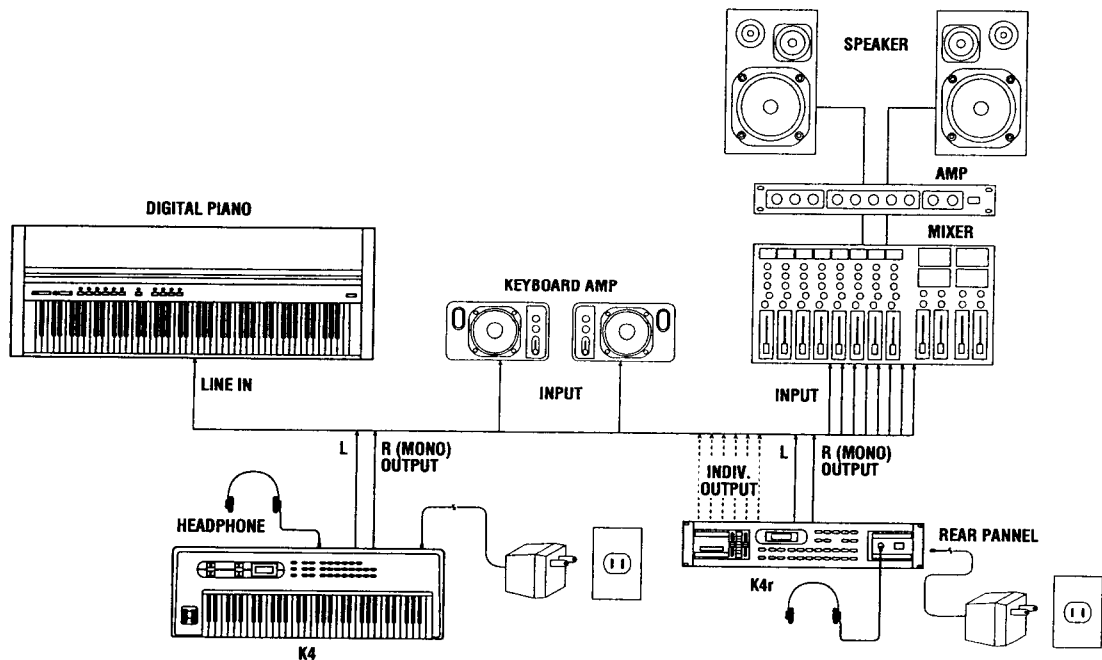

Note: The K4/K4r has no internal power amp. or speakers. In order to obtain sound output, you may either use headphones, or connect it to a keyboard amp. or PA system. It is possible to use home radio cassette players or audio amps, but caution should be paid to when the power is turned on and to volume, etc., in order to avoid damage to these appliances.

```
*KAWAI K-4*
SYNTHESIZER
```

```
*KAWAI K-4r*
SYNTHESIZER
```

```
SINGLE
IA-1 C. Grand
```

- (2) Turn the POWER switch at the right of the rear (K4r: front) panel on. This display lasts only a few seconds.
- (3) The unit is now ready to play.
- (4) The K4/K4r retains in memory the parameters in it when the power was turned off. When the POWER has been turned on again, you may call up the patch that was being played at that time by pressing the **RECALL**.
- (5) Turn on the power of amps and other equipment connected to the K4/K4r after turning the K4/K4r on, to protect the other equipment.

1-2. Let's Play!

First, let's take a look at the tones currently stored into the memory of the K4/K4r.

1. Selecting a PLAY Mode (SINGLE or MULTI)

With the K4/K4r, each single tone is referred to as a SINGLE Patch, and the combined setting of multiple patches is referred to as a MULTI Patch.

1) SINGLE PLAY

64 different SINGLE Patches may be stored into the internal memory of the K4/K4r. These are stored into the four banks, A–D, each of which can store 16 patches (for a total of 64). Cards may also be used to store an additional 64 patches, 16 in each of the four banks from A–D.

<Procedure>

- (1) Press **SINGLE** to select SINGLE PLAY.
- (2) With every further press of the **SINGLE**, the unit switches between the INT (inside the unit itself) and EXT (card) memories.

I: INT (internal) memory
E: EXT (card) memory

- (3) Select a bank from **A** to **D**.
- (4) Select a number from **1**–**16**.

- (5) When switching between SINGLE Patches, if the patches are in the same bank, repeat step 4. When they are in the same block, repeat steps 3 and 4.

```
SINGLE
IA-1  C. Grand
```



```
SINGLE
EA-1  Ultra 7th
```

Selection

```
SINGLE
IA-1  C. Grand
```

Bank Number Patch name
Block

A SINGLE Patch has now been selected.

Note: The tone patch names and numbers used in this manual are not necessarily the same as those on your K4/K4r.

2) MULTI PLAY

Sixty-four different MULTI Patches may be stored into the internal memory of the K4/K4r. Split and Layer play is possible with a maximum of eight different instruments (See P. 61). These are stored into the four banks, A–D, each of which can store 16 patches (for a total of 64). Cards may also be used to store an additional 64 patches, 16 in each of the four banks from A–D.

```
MULTI
IA-16  HORIZON
```



```
MULTI
EA-16  P:I:C:0
```

<Procedure>

- (1) Press **MULTI** to switch to MULTI PLAY.
 - (2) With every further press of the **MULTI**, the unit switches between the INT (inside the unit itself) and EXT (card) memories.
- I: INT (internal) memory
E: EXT (card) memory
- (3) Select a bank from **A** to **D**.
 - (4) Select a number from **1** – **16**.
- (5) When switching between MULTI Patches, if the patches are in the same bank, repeat step 4. When they are in the same block, repeat steps 3 and 4.

A MULTI Patch has now been selected.

Note: MULTI Patches contain numerous settings. Pressing a few keys on the keyboard is not enough to allow you to determine what kind of patch settings have been made: go ahead and play the keyboard from one end to the other, hitting the keys hard and hitting them softly, holding the keys down after you have pressed them, etc., to see what the current settings are.

2. Possibilities of MULTI PLAY Mode

This section explains the basic functions of the MULTI PLAY mode.

● SPLIT

The keyboard may be divided into a maximum of eight segments and each assigned a different (SINGLE Patch) tone. For instance, the low range might be assigned to the bass, the middle range to the piano and the high range to the strings to allow the playing of several different tones on different parts of the keyboard (ID 1–4). (See P. 86)

● VELOCITY Switch

Tones may be changed by varying the amount of force applied to the keys during play (at a maximum of two settings per key). For instance, key settings may be made so that a light strike will produce a bass tone, whereas a strong strike will produce a chopper bass tone. Differing tones may also be combined to produce a completely new tone (ID 5–8). (See P. 87)

● LAYER

A maximum of eight tones may be combined into a single sound. A very fat sound may be obtained by combining and slightly detuning similar tones, and a completely new sound created by combining different tones (ID 9–12). (See P. 85)

● MULTI tone generator

If each of the MIDI receiving channels of a MULTI Patch is set independently, a maximum of eight (nine including the DRUM Section) MIDI tone generator modules may be created. The unit keyboard may be used to play different tones or control external tone generators while the K4/K4r is played by a computer or MIDI sequencer such as the Q-80 (ID 13–16). (See P. 83)

All of the above functions may be freely combined in a single MULTI Patch.

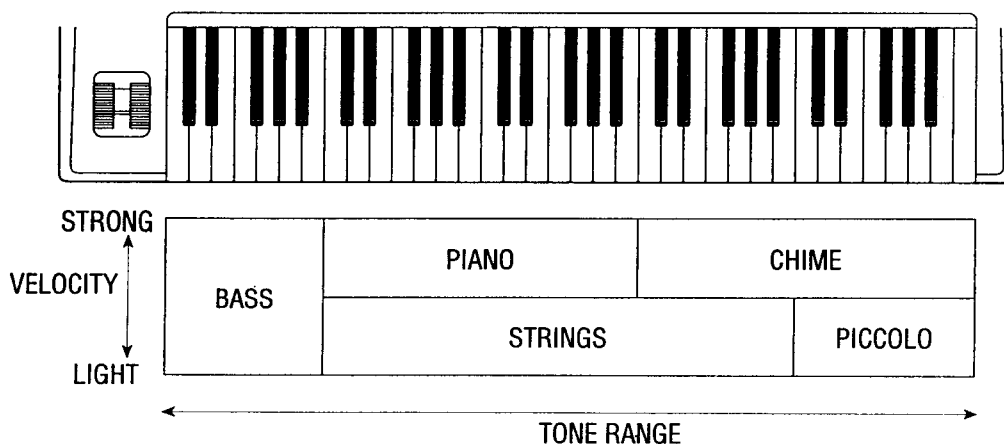

3. Tuning and Transposing

■ TUNE

(Value: -50 to 0 to +50)

TUNE enables fine tuning of the overall pitch of the K4/K4r, and is used when tuning the synthesizer to other instruments, like a piano.

Note: The pitch tuning of the K4/K4r is based on A3=440 Hz and can be raised or lowered up to a maximum of a half tone (100 cents) in increments of 2 cents.

```
SYSTEM/MIDI
                      =SYS
```

```
SYSTEM
TUNE                = 0
```

<Procedure>

- (1) Press **SYSTEM**.
- (2) Use the VALUE Slider or **+YES** and **-NO** to call up the SYS display.
- (3) Press **SYSTEM** several times to call up the TUNE display.
- (4) Use the VALUE Slider or **+YES** and **-NO** to fine tune the pitch.

■ TRANSPOSE

(Value: -12 to 0 to +12)

The pitch of the K4/K4r can also be transposed up or down in half tone units, allowing you to finger in any key as though it were the key of C.

```
SYSTEM/MIDI
                      =SYS
```

```
SYSTEM
TRANSPOSE          = 0
```

<Procedure>

- (1) Press **SYSTEM**.
- (2) Use the VALUE Slider or **+YES** and **-NO** to call up the SYS display.
- (3) Press **SYSTEM** several times to call up the TRANSPOSE display.
- (4) Set the VALUE Slider, **+YES** or **-NO**.

4. LINK Play

This function allows patches to be called up in a specified order during LINK Play by merely pressing the **+ YES** and **- NO**. Any eight of the 256 patches in the unit or card may be selected and stored regardless of whether they are MULTI or SINGLE Patches, in the unit, or on a card.

■ How to set a LINK

```
SYSTEM/MIDI
                =SYS
```

```
LINK    MIA-1
1st
```

<Procedure>

- (1) Press **SYSTEM**.
- (2) Use the VALUE Slider or **+ YES** and **- NO** to call up the SYS display.
- (3) Press **SYSTEM** several times to call up the LINK 1st display.
- (4) Use the VALUE Slider or **+ YES** and **- NO** to select the first patch in the LINK.
- (5) For the 2nd and later patches, repeat steps (3) and (4).
- (6) When there are 8 or fewer patches to be stored for a LINK, press **- NO** and turn off every time a patch is selected with (4).
- (7) To return to the PLAY mode while setting a LINK, first press **MULTI** or **SINGLE**, then chose the desired patch.

5. DRUM Play

The K4/K4r provides a separate DRUM Section independent of SINGLE Patches or the eight MULTI Patch Sections. A Q-80 MIDI sequencer, etc., may be used to play the DRUM Section while the keyboard is being played.

■ MANUAL DRUM

The DRUM Section may be controlled from the keyboard.

Notes: There are two DRUM Sections available in the K4/K4r when a Card is inserted in the Card Slot. One is Internal, the other is the Card (external). If you select an internal SINGLE or MULTI Patch, the internal DRUM Section is selected. Selecting an external SINGLE or MULTI Patch automatically selects the external DRUM Section.

To SAVE and LOAD the DRUM Section to the Card, see p. 70.

If the MIDI transmit channel of the controlling MIDI instrument and the DRUM Section receiving channel of the K4r (channel 10 at time of factory shipment) are not the same, no sound will be produced.

<Procedure>

```
DRUM
VOLUME      = 100
```

```
DRUM
RCV CH      = 10
```

- (1) Press **DRUM** to call up the DRUM Section.
- (2) Use the VALUE Slider or the **+YES** or **-NO** as required to adjust the volume of the DRUM Section.
- (3) Press **DRUM** to call up the receiving channel set display.
- (4) Use the VALUE Slider or the **+YES** or **-NO** as required to set the MIDI receiving channel.

6. Playing Using a Computer or Sequencer

One way to make effective use of the K4 MULTI Section is to use a Q-80 or other MIDI sequencer, or a computer for automatic play. In this way, 1 or 2 Sections can be played manually, while the DRUM Section can be controlled by a Q-80 or other MIDI sequencer or a computer. (See P. 83, 88)

■ Connection to an external MIDI device

The K4/K4r controlled by an external computer or recording with a Q-80 MIDI sequencer

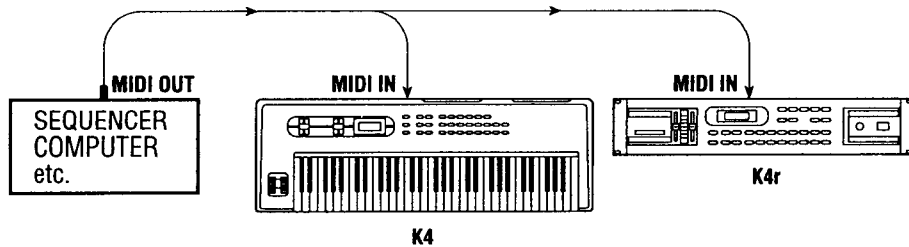

The K4 controlling to a MIDI tone generator

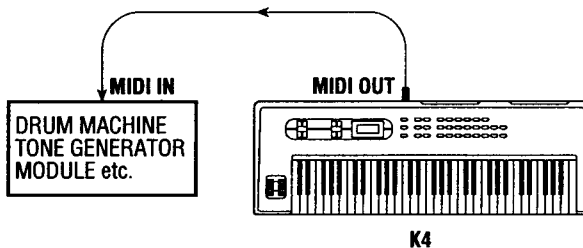

■ Note Information

Of the different types of performance data which can be transmitted via MIDI, the most basic is the note message. Note messages indicate such information as which key has been pressed with how much force, and when it was released.

■ Note Number

In order to enable the control instrument to differentiate between keys when they are played, a number is assigned to each, called a note number. Middle C (C3) is MIDI note number 60, and each note number corresponds to a half tone, or one key on the keyboard (MIDI divides the half tones from C-2 to G8 into 128 steps, numbering them in sequence from lowest to highest).

■ Velocity

This is a message which tells with how much force a key on the keyboard was pressed (velocity is detected not by the pressure on the key, but by the speed of its movement at the time the note on message is sent).

■ Aftertouch

Numerous kinds of effects may be obtained by pressing harder after a key has once been pressed. Aftertouch is a message which transmits the amount of pressure with which a key is being pressed.

■ Program Change

Most MIDI instruments currently in use allow settings, tones, and other data to be programmed. These programs can be switched by a message from the master instrument. This type of message is called a program change. Since MIDI standards say only that numbers from 0 to 127 can be used as program change data, the items in the tone memory that correspond to the program change numbers are different for every type of instrument.

■ Control Change

Besides information regarding when a key has been pressed and released and so on, volume, vibrato, hold, portamento on/off, damper and soft pedal on/off, pan and aftertouch information, etc., are functions which may be handled in many different ways as performance data. These are transmitted as control change messages.

■ Pitch Bend

This is a message which tells just how far the pitch bend wheel has been turned. The maximum amount of pitch bend is usually programmed in the synthesizer's patch data. Therefore, pitch range depth may differ between instruments.

■ Exclusive Messages

While MIDI is a standard accepted world-wide, in order to get the most out of the different types of equipment produced by different manufacturers, each produces to some extent, their own independent specifications. These are outside of the specifications prescribed by MIDI, and consist of messages for the transmission and reception of information unique to a particular piece of equipment. Called "system exclusive messages," these may be used to exchange tone data between equipment produced by the same manufacturer and for storing tone data to a computer.

■ Others

● LOCAL Control On/Off

LOCAL Control is a message for the transmission of keyboard and tone data within the MIDI system. When LOCAL Control is turned off, keyboard data is not sent to the internal tone generator, but only to the MIDI OUT jack. This function is often used for the external control of a MIDI tone generator module that is different than the keyboard being used, or to use only the keyboard as a MIDI keyboard controller.

● All Notes Off

This is a message which stops all sounds currently being produced.

● Active Sensing

The purpose of this message is to prevent a bad cable or connection from causing stuck notes.

● Reset

This message reinitializes the unit while the power is still on.

● Common

This indicates the selection or location of a song when a MIDI sequencer or drum machine are being played in sync.

● Real Time

This message indicates the timing clock or start/stop, etc., when a synthesizer, drum machine or other device are being played in sync.

Implementation chart`

Data which can be transmitted and received by MIDI equipment includes only that which is common to both the transmitter and receiver. MIDI is actually nothing more than a standard which enables the transmission of performance data via a MIDI cable; the implementation chart is merely a chart which states what the equipment is capable of. Each different type of equipment has its own characteristics, and capabilities. This goes for MIDI standards as well: some capabilities are not compatible with some types of equipment. That is why each MIDI unit comes with a list of the types of data it is capable of receiving and sending, called the MIDI implementation.

MIDI and rhythm performance

The K4/K4r has a rhythm sound generator, and although drum sounds can be played from the keyboard, it is generally more practical to create an ensemble using a Q-80 or other MIDI sequencer or drum machine. The rhythm sound generator may be used to create many different kinds of tones simultaneously. Because of the number of drum sounds in the K4/K4r, each sound is allocated to a single note number on the same MIDI channel.

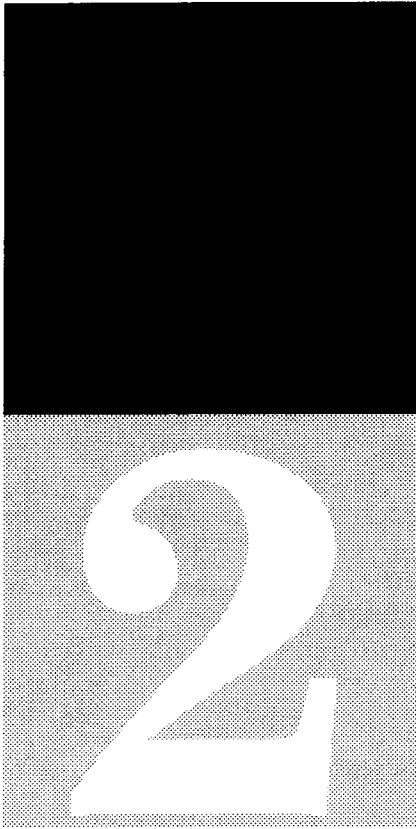

Chapter 2. Applications

This chapter explains the creation and editing of tone data, as well as how to combine the tones for a variety of setting and effects.

2-1. K4/K4r Structure of Patches

2-2. The Tone Editing Process

2-3. Saving and Loading Data

2-4. Before Entering EDIT Mode

2-5. Editing a SINGLE Patch

1. SINGLE Patch Configuration
2. SINGLE Patch Parameters

2-6. Editing a MULTI Patch

1. MULTI Patch Configuration
2. Using MULTI Patches
3. Choosing a Section to Edit
4. Editing Section Parameters

2-7. Editing Sounds for the DRUM Section

1. DRUM Section Configuration
2. Editing the DRUM Section
3. Writing the DRUM Section

2-8. EFFECT (K4) and OUTPUT (K4r) Settings

1. EFFECT Patches (K4 only)
2. OUTPUT Patches (K4r only)
3. Programming Parameters
4. Explanation of Effect Type (K4 only)
5. Writing EFFECT and OUTPUT Settings

2-9. SYSTEM Programming

1. SYS (SYSTEM) Group
2. TRS (Transmit) Group
3. RCV (Receive) Group

2-1 K4/K4r Structure of Patches

K4/K4r Configuration

Besides SINGLE and MULTI Patches, the K4 contains 32 EFFECT Patches; the K4r contains 32 OUTPUT Patches.

As shown in the structure, it is possible to feed the signal from a SINGLE Patch into the desired SUBMIX Channel (lettered A to H).

It is also possible to feed the signal from each of the eight Sections of a MULTI Patch into the SUBMIX Channel in the desired fashion.

Furthermore, one may feed each of the 61 tones of the DRUM Section into the SUBMIX Channels as with the SINGLE and MULTI patches.

The following structure shows the K4/K4r Patches.

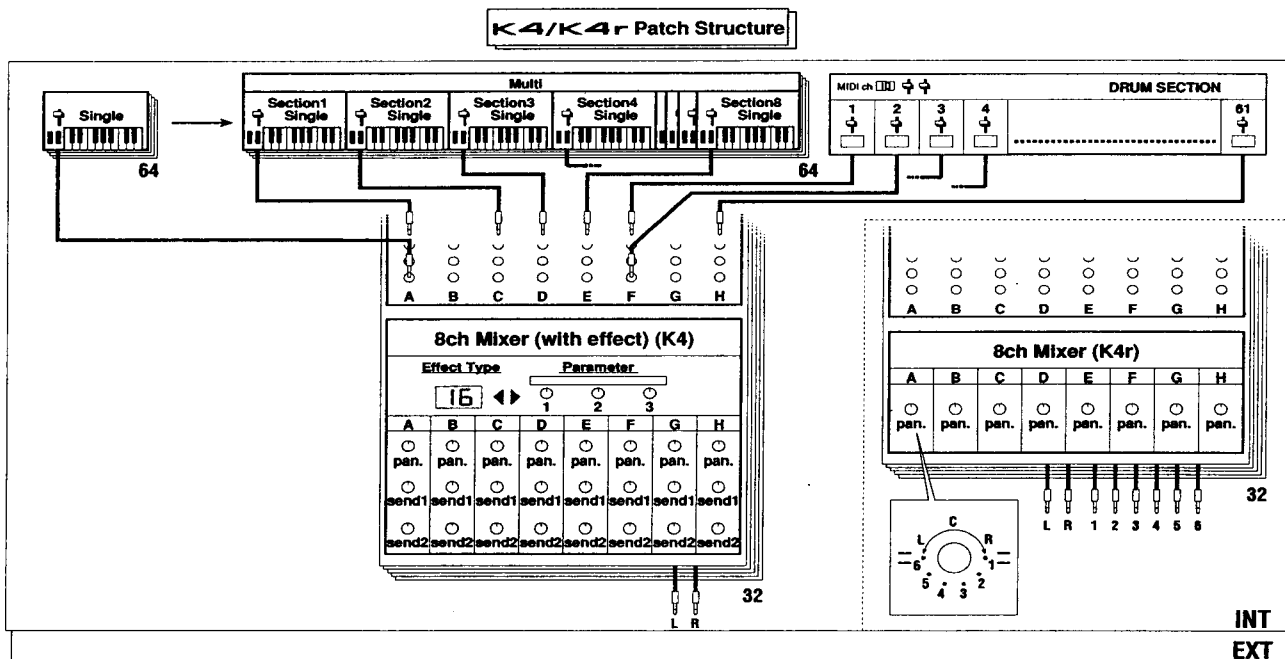

Notes: SUBMIX CH can be programmed to overlap. For example, the output signal from all eight Sections of a MULTI Patch can be fed into a single SUBMIX CH.

An EFFECT (K4) or OUTPUT (K4r) Setting number can be stored for each SINGLE and MULTI Patch. For SINGLE Patches see P. 33; for MULTI Patches see P. 61 and for DRUM Section see P. 68.

2-2. The Tone Editing Process

STRUCTURE OF PATCHES

The K4/K4r has many programmable parameters. When creating or editing sounds it is best to start with a goal and work to reach that goal.

- **Find a tone to serve as a basis for editing.**

Though "sound creation" may be your goal, creating a tone from scratch is generally quite difficult. It is easier and more effective to find and modify a preset tone which is close to the one you're attempting to create. Since the preset tones have been designed to make full use of the K4/K4r's capabilities, one can learn quite a bit about sound creation on the K4/K4r by modifying them.

- **Decide how to alter the tone.**

If you set a goal for editing then you will know which parameters must be altered. For example, if you wish to change the attack or some other amplitude parameters, then you must alter the DCA; to make the tone more or less brilliant, you must modify the DCF.

- **Change the waveform.**

It is possible to alter the feel of a tone by simply altering the waveform, even if all other parameters are unchanged. If a similar waveform is selected, the change will be subtle; using a much different waveform will create a very different sound.

- **Combine sounds.**

You can make use of MULTI PLAY in sound creation as well, to create a wide variety of sounds. You can layer the same sound and perhaps detune the pitch a little, to create a sound much deeper than the original tone alone. Or you can combine a number of different tones to create an orchestra-like sound. The possibilities are limited only by your imagination.

- **Add effects (K4 only).**

There are usually effects added to sounds such as those you hear on the radio or CD's. Effects are an important element in the creation of complete, polished sounds. The K4r is designed to be used with external effects devices.

- **Manipulate settings.**

Manipulating settings such as Velocity and Modulation, especially in combination in a MULTI Patch, can create even more realistic and sophisticated sounds.

2-3. Saving and Loading Data

The memory of the K4/K4r can hold 64 SINGLE Patches and 64 MULTI Patches (the latter containing up to 8 single tones each), for a total of 128 patches, plus DRUM Section and EFFECT (K4) or OUTPUT (K4r) Settings. At the time your synthesizer left the factory, the "factory presets" (a selection of patches and settings designed to make good use of the K4/K4r's capabilities) were stored in its memory. You will find that editing these tones to create new ones suiting your taste an easy and pleasant task. Tones so edited can be stored in the memory, and will be described later; but the data originally stored there will be erased. In case you want to keep the factory presets, you should either store them in an optional card (DC-16) or copy them by MIDI DATA DUMP into a computer or a sequencer such as the Q-80.

Notes: Be sure to use only the designated memory card (DC-16).

When using a card, please read the accompanying instruction manual carefully.

Do not cut the synthesizer's power during a LOAD or SAVE operation, as it may destroy any data stored in the card and/or the synthesizer's memory.

Should you wish to SAVE or LOAD individual patches, or DRUM Section, EFFECT (K4) or OUTPUT (K4r) Settings, please refer to the descriptions of the WRITE operations in each section. (For SINGLE Patches, see P. 58; for MULTI Patches, see P. 65; for EFFECT (K4) or OUTPUT (K4r) Settings, see P. 76; and for the DRUM Section, see P. 70.)

CARD FORMAT

New cards and cards which have been used in other machines must be formatted before they can be used with the K4/K4r.

Note: When the FORMAT procedure is performed, all data already stored in the card will be erased. PROTECT will not work when formatting, so be sure to check the contents of a card before you format it.

<Procedure>

- (1) Insert the card into the card slot (in the rear panel of the K4, or the front panel of the K4r) so that the ▼ mark and the ▲ mark are aligned.
- (2) Press repeatedly until CARD FORMAT appears on the display.
- (3) Press to FORMAT, or to quit.
- (4) If you press , the message SURE? will appear on the display to ask for confirmation.
- (5) Press again to continue, or to quit.
- (6) Continue with the SAVE operation.

```
CARD FORMAT
EXEC?=Y/N
```

```
CARD FORMAT
SURE?=Y/N
```

```
COMPLETED!
```

```
CANCELED!
```

DATA SAVE

This procedure copies all patch, EFFECT (K4) or OUTPUT (K4r) Setting and DRUM Section data from the synthesizer to the card.

Note: When the SAVE procedure is performed all data already stored in the card will be erased.

<Procedure>

```
SAVE TO CARD
EXEC?=Y/N
```

+YES

```
COMPLETED!
```

-NO

```
CANCELED!
```

- (1) Press **WRITE** repeatedly until SAVE appears on the display.
- (2) Press **+YES** to SAVE, or **-NO** to quit.
- (3) If you press **+YES**, the message SURE? will appear on the display to ask for confirmation.
- (4) Press **+YES** again to continue, or **-NO** to quit.
- (5) Press **WRITE** repeatedly until card PROTECT appears on the display.
- (6) To protect the card data, set the memory PROTECT switch to ON. (See DATA LOAD below)

DATA LOAD

This procedure copies all patch, EFFECT (K4) or OUTPUT (K4r) Setting and DRUM Section data from the card into the synthesizer.

Note: When the LOAD procedure is performed all data already stored in the synthesizer will be erased.

<Procedure>

```
INTERNAL
PROTECT =ON
```

```
LOAD FROM CARD
EXEC?=Y/N
```

```
LOAD FROM CARD
SURE?=Y/N
```

+YES

```
COMPLETED!
```

-NO

```
CANCELED!
```

- (1) Insert the card into the card slot (in the rear panel of the K4, or the front panel of the K4r) so that the ▼ mark and the ▲ mark are aligned.
- (2) Press **WRITE** repeatedly until internal PROTECT appears on the display.
- (3) Press **-NO** to turn the PROTECT switch to OFF.
- (4) Press **WRITE** repeatedly until LOAD appears on the display.
- (5) Press **+YES** to LOAD, or **-NO** to quit.
- (6) If you press **+YES**, the message SURE? will appear on the display to ask for confirmation.
- (7) Press **+YES** again to continue, or **-NO** to quit.
- (8) To protect internal patch data, return the Internal PROTECT switch to ON.

2-4. Before Entering EDIT Mode

The Basics of Editing

Editing is the creation or alteration of synthesizer tones and settings. This operation can be performed in the EDIT mode.

Note: You will need to use the WRITE operation to store edited data for future use.

```
TONE WRITE
TO           =IA-1
```

```
TONE WRITE
EXEC?=Y/N
```

Note: Data that is not stored using the WRITE operation will not be changed in the memory. Therefore, feel free to try editing the preset data and see how each setting change affects the actual sound produced.

How to Enter EDIT Mode

You may edit SINGLE patches in SINGLE EDIT mode, and MULTI Patches in MULTI EDIT mode. Entering EDIT mode is the same in either case.

```
SINGLE
IA-1 C. Grand
```

```
SIA-1 C. Grand
VOLUME      =100
```

<Procedure>

- (1) Call up the patch to be edited on the display.
- (2) Press **EDIT** to enter EDIT mode.

Calling up Parameters and Assigning Values on the K4/K4r

Parameters are divided into groups according to function, and then assigned to various switches.

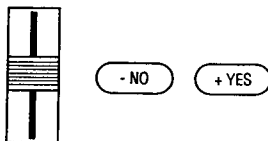

<Procedure>

- (1) The parameter groups are assigned to switches A, B, C, D, and 1 through 16 on the panel. Press the switch for the proper parameter group repeatedly until the desired parameter appears on the display.
- (2) If you accidentally pass the parameter you want, press **PREV** to return to it.
- (3) The VALUE Slider may be used to change the value greatly; to change it slightly, press **+YES** or **-NO**.
- (4) To compare the edited sound with the original, press **RECALL COMPARE**. The value before editing will appear on the display, and by playing the keyboard you can hear the original sound.
- (5) Press the **RECALL** again to continue editing.
- (6) To stop editing, press **SINGLE** or **MULTI**.

```
RECALL
```

Note: If you accidentally leave EDIT mode, press **RECALL**. The following display will appear, and you can return to EDIT mode by pressing **EDIT**.

2-5. Editing a SINGLE Patch

1. SINGLE Patch Configuration

This section describes the process from the pressing of a key on the keyboard (that is, the reception of a KEY ON signal) to the actual production of a sound, and explains how each part of the K4/K4r operates.

■ The Sound Production Process

The K4/K4r configuration consists of three blocks: DCO, DCA, and DCF. The K4 adds a fourth, EFFECT.

● DCO

The DCO receives information from the keyboard concerning which key is pressed, and outputs the preselected basic tone (either DC or PCM waveform) at the pitch of the key that was pressed.

● DCA

The DCA adjusts the volume of the signal sent from the DCO. It does not merely set the output volume of the signal; it determines the change in the signal's volume over a period in time as well.

● DCF

The DCF adjusts the sound quality of the tone sent from the DCA. The DCF basically operates like a tone control; however, they are essentially different in that the DCF adjustment can be set to vary over time.

● EFFECT (K4 only)

It is also possible to add a digital effect to the sounds produced by the synthesizer unit. Synthesized sounds often lack the warmth and ambience of acoustic instruments. It is therefore helpful to add a sense of spatial depth with effects such as Reverb, Chorus and Delay, or distort the sound with Overdrive, to give it a greater sense of realism.

● INDIVIDUAL OUTPUT (K4r only)

In addition to the stereo left and right output jacks, the K4r has six Individual Output jacks. In SINGLE PLAY mode, for example, by outputting the DRUM Section through the stereo jacks, the snare through Individual Output jack #1, the kick through jack #2, and the SINGLE Patch through jack #3, it is possible to process each sound differently through an external effects devices.

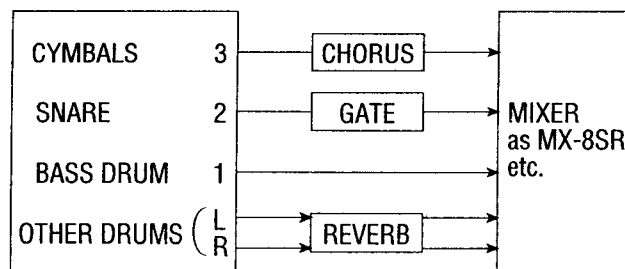

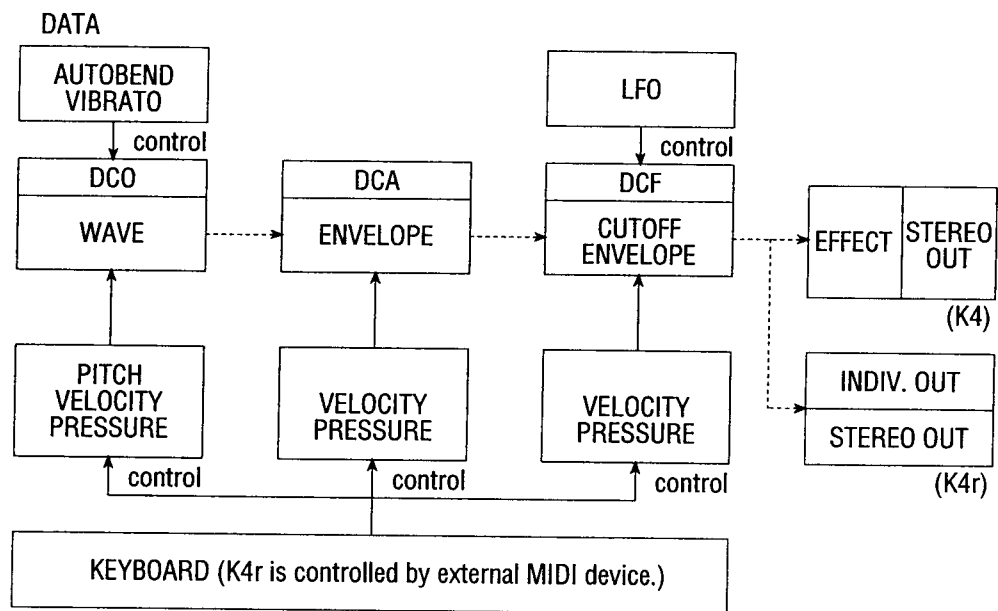

■ The K4/K4r Tone Generator

The K4/K4r produces sounds by a system known as DMS Tone Generation. Natural sounds exhibit complex variations in harmonic composition which are very difficult, if not impossible, to reproduce artificially using a single waveform, as would be the case with a conventional synthesizer. DMS Tone Generation makes sound creation easy by temporarily separating the sound into its component elements. It is comparatively easy to create even complex harmonic variations by combining these elements. The K4/K4r is capable of separating a tone into up to four such elements.

■ The K4/K4r's Internal Waveforms

By combining the characteristics of PCM and DC waveforms, the K4/K4r allows free creation of a wide variety of tones.

● PCM Waveforms

Conventional synthesizers were able to produce only waveforms such as triangle or sawtooth waves having comparatively simple harmonic configurations. They could not produce metallic sounds and other tones with complicated harmonic components. The K4/K4r has solved this problem by making use of PCM waveforms.

Note: *PCM, or Pulse Code Modulation, is a method of reproducing sounds such as those of acoustic instruments by converting them into a digital signal and recording them. The K4/K4r's internal PCM waveforms have a reproduction quality equal to that of a CD.*

● DC (Digital Cyclic) Waveforms

DC waveforms consist of Cyclical PCM sounds which have been analyzed and recombined so that they are easy to process. It is useful to combine DC waveforms with PCM waveforms or with other DC waveforms for best results.

■ AM (Ring Modulation)

AM (Ring Modulation) is a system which combines two signals to create a single, more complex signal. One waveform is used to modulate or cause a change in the other, so unlike the DCF, which reduces harmonics, this system can produce new harmonics which were not included in either original waveform, allowing the creation of metallic, distorted or otherwise forceful sounds.

Note: *Keep in mind that it is important to give careful consideration to the extent of level modulation when using AM. (See P. 35)*

■ Choosing a Source to Edit

Each Source must be set individually for SINGLE Patches.

<Procedure>

- (1) Select the Source to be edited using the Source Select switches 1, 2, 3, or 4.

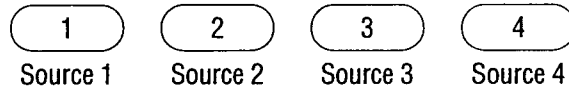

- (2) To listen to a Source's sound individually, use the Source Mute switches 9, 10, 11, and 12 to mute the other Sources temporarily.

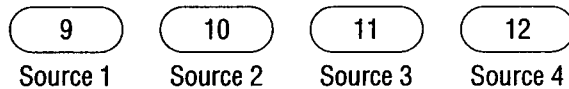

- (3) When editing filter parameters, select the desired Filter using the Source Select switches 1, 2 (for Filter 1) and 3, 4 (for Filter 2) as below:

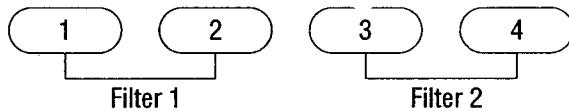

■ Display During Editing

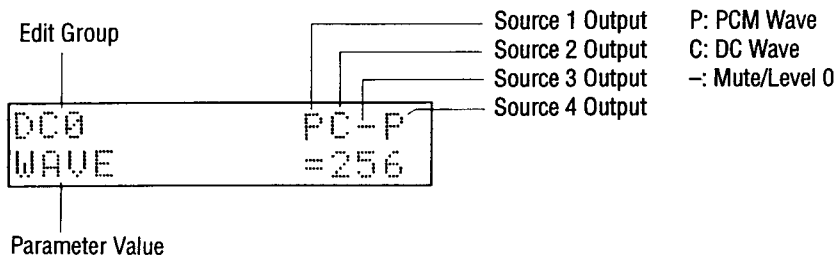

2. SINGLE Patch parameters

■ EDIT Group

```
SIA-1 C. Grand
VOLUME =100
```

● VOLUME

(Value: 0–100)

This controls the volume of all SINGLE Patches. The differences in volume between patches are adjusted so as to avoid any unnaturalness when switching between patches.

```
SIA-1 C. Grand
EFFECT PACH= 32
(OUTPUT)
```

● EFFECT (K4)/OUTPUT (K4r)

(Value: 1–32)

This allows selection from among the 32 EFFECT (K4)/OUTPUT (K4r) Settings made previously. (See P. 24, 71)

```
SIA-1 ABCDEFGHIJ
SUBMIX CH = H
```

● SUBMIX CH

(Value: A–H)

K4

A single EFFECT may contain as many as eight different OUTPUT mode settings that determine the level of EFFECT and sound image orientation. This allows you to select which type mode among these eight modes to use. (See P. 24, 71)

K4r

The K4r has stereo L, R and six Individual Output jacks. Eight OUTPUT mode settings may be made regarding whether orientation is to be determined by stereo L, R and whether to provide output through a single source, from which the mode to be used may be selected. (See P. 24, 71)

Note: The K4r does not have EFFECT Settings.

```
SIA-1 ABCDEFGHIJ
NAME 1st = A
```

● NAME 1st-10th

Edited patches are given names consisting of ten characters.

Notes: Move the cursor with the **EDIT** and **PREV** then select a number or letter with the VALUE Slider, **+YES** and **-NO**.

The following list gives the characters which may be used for a patch name.

Valid name characters

```
■, !, ", #, $, %, &, ', (, ), *, +, -, ., /
0, 1, 2, 3, 4, 5, 6, 7, 8, 9
:, ;, <, =, >, ?, @
A, B, C, D, E, F, G, H, I, J, K, L, M, N, O, P, Q, R, S, T, U, V, W, X, Y, Z
[, \, ], ^, -, `
a, b, c, d, e, f, g, h, i, j, k, l, m, n, o, p, q, r, s, t, u, v, w, x, y, z
{, |, }, →, ←
```

■ COMMON Group

These are set to act on all Sources of a SINGLE Patch.

- Source mode
- AM 1 → 2
- AM 3 → 4
- POLY mode
- Pressure → Freq.
- Wheel Assign
- Wheel Depth
- AUTO BEND Time
- AUTO BEND Depth
- AUTO BEND KS (Keyboard Scaling)
- AUTO BEND Velocity

● Source mode

(Value: NORM, TWIN, DBL)

Combinations of DCO and DCA are called "Sources." With the K4/K4r, four Sources may be combined to create a tone.

```
COMMON          PCCP
SOURCE MODE=DBL
```

This sets the Source combination and how the Filter will be used with the Source.

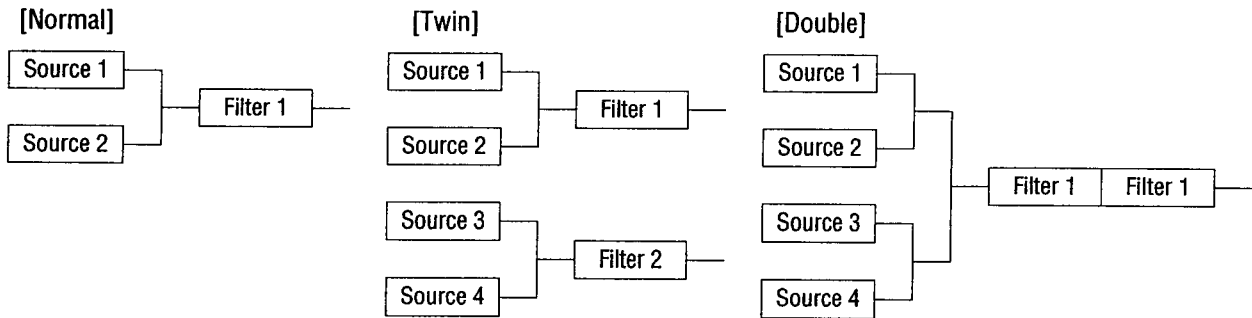

Note: Choosing "TWIN" or "DBL" makes the K4/K4r an 8-voice polyphonic instrument – that is, limited to sounding a maximum of 8 notes at a time.

```
COMMON      PCCP
AM 1>2      =ON
```

(3>4)

● **AM (Ring Modulation)**

(Value: ON,OFF)

This sets whether the Ring Modulation wave type is to be used with Source 1 (3). When this value is ON, wave 1 (3) is used to distort wave 2 (4).

Note: When AM is in use, Source Mute is enabled. A setting may be made as to whether to output the sound or mute for the modulator side. (See P. 32)

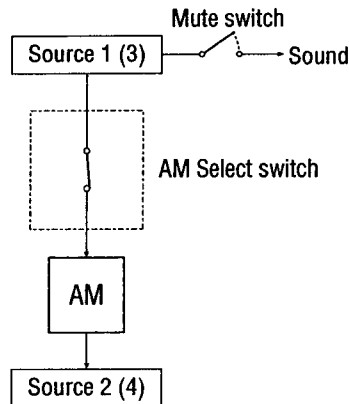

● **POLY mode**

(Value: PLY1, PLY2, SOL1, SOL2)

Sets the way the SINGLE Patch is to sound.

```
COMMON
POLY MODE  =PLY1
```

● **PLY1 (Poly 1)**

This mode cuts off the previous note each time the same note is struck.

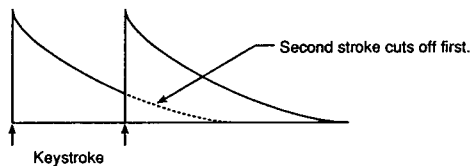

● **PLY2 (Poly 2)**

This mode allows the previous note to sound each time the key is struck. When the number of tones which may be created at one time is exceeded, the tone of the next key pressed will take priority.

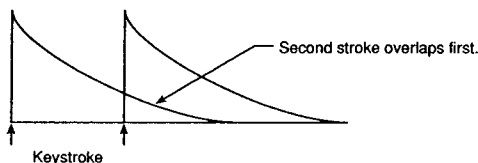

- **SOL1 (Solo 1)**

This is used to produce only monophonic sound without harmony.

Note: When one key is held down and another key pressed, when the second key pressed is released, the tone produced by the first key will still be made.

With a SINGLE Patch, because the K4/K4r can be used as a monophonic synthesizer, it is outstanding as a fat lead synthesizer for rock music. When a key is pressed down and held and the next key pressed, after the second key is released, the sound of the first key remains. This works well with fast passages.

- **SOL2 (Solo 2)**

This is basically the same in principle as SOL1 above, but when a second or further keys are pressed while a first is being held down, there is no attack phase for those following the first. This is good for producing real tone variation, such as for a distorted lead guitar or solo violin.

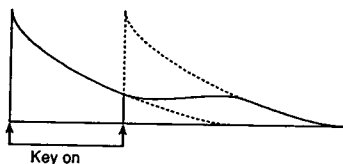

- **BENDER RANGE**

(Value: 0-12)

```
COMMON      PCCP
BNDR RANGE = 12
```

This sets the amount of pitch variation when using Pitch Bend. The range is from a semitone to a maximum of one octave variation.

- **PRESS FREQ**

(Value: -50 to 0 to +50)

```
COMMON      PCCP
PRESS>FREQ = -50
```

Sets the level of Aftertouch (the effect of pressing a key even harder once again after having pressed and held it down). When this is a negative value, this decreases with the increase in pressure applied to the key.

The type and level of effect of Aftertouch varies with the tone setting.

● **WHEEL ASSIGN**

(Value: VIB, LFO, DCF)

Sets the type of effect that will take place when the Modulation Wheel has been used.

```

WHEEL      PCCP
ASSIGN     =VIB
    
```

VIB → causes the Vibrato Effect.
 LFO → causes the Wah wah Effect.
 DCF → adjusts Filter Cutoff

● **WHEEL DEPTH**

(Value: -50 to 0 to +50)

Adjusts the level of effect when the Modulation Wheel has been used. When this is a positive value, the effect increases with the increase in the amount of use of the Wheel.

```

WHEEL      PCCP
DEPTH     =-50
    
```

■ **AUTO BEND**

Pitch Bend can be set to go into effect automatically upon the strike of a key. When the set value is made small, the pitch changes of sounds characteristic to ethnic and lead instruments can be reproduced. When the value is made large, effects such as tabla and electric tom can be created.

● **TIME**

(Value: 0-100)

Sets the Auto Bend depth duration.

```

AUTO BEND PCCP
TIME      =100
    
```

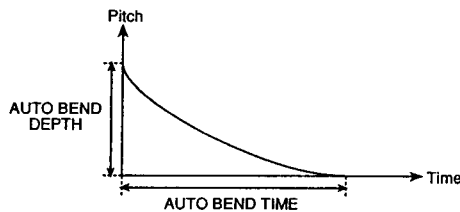

Value	Effect
0	No effect
5	}
100	

Sets the amount of time before Vibrato takes effect after a key is pressed.

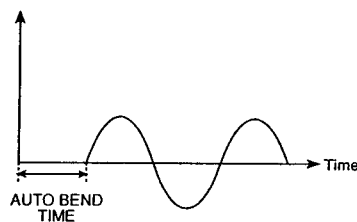

● DEPTH

(Value: -50 to 0 to +50)

Sets the pitch variation amplitude for Auto Bend.

```
AUTO BEND PCCP
DEPTH      =-50
```

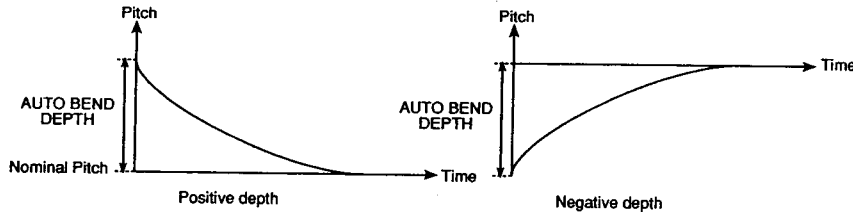

Value	Effect
+50	Pitch drops to nominal value
}	}
0	No effect
}	}
-50	Pitch rises to nominal value

● KS TIME

(Value: -50 to 0 to +50)

The Auto Bend time duration can vary with the location on the keyboard. This variation is determined by the KS Curve. (See P. 45)

```
AUTO BEND PCCP
KS>TIME   =-50
```

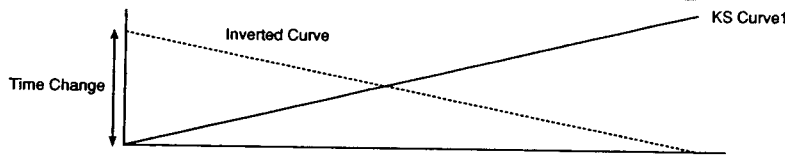
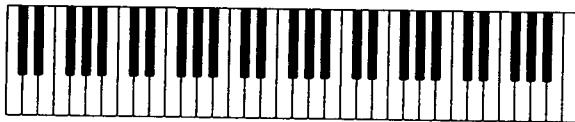

Value	Effect
+50	Maximum effect with normal KS curve
}	}
0	No effect
}	}
-50	Maximum effect with inverted KS curve

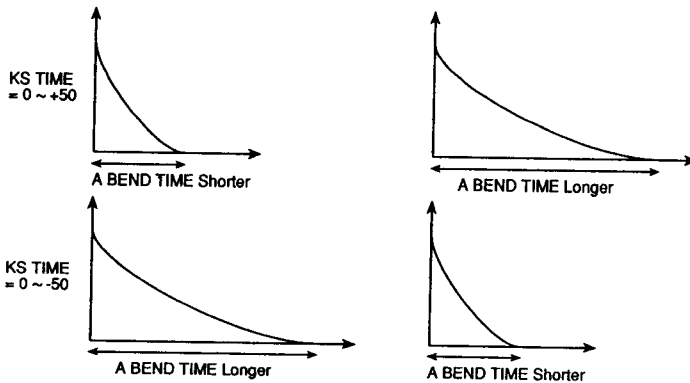

● **VEL DEPTH**

(Value: -50 to 0 to +50)

Auto Bend pitch depth of change can be varied depending on the amount of pressure placed on the keys while playing.

```
AUTO BEND PCCP
VEL>DEPTH =-50
```

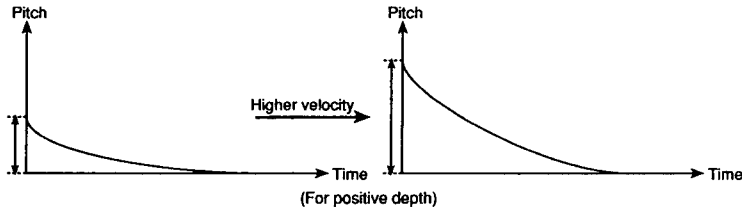

Value	Effect
+50	Depth increases with velocity
}	}
0	No effect
}	}
-50	Depth decreases with velocity

SINGLE EDIT

■ LFO GROUP

Vibrato may be obtained by adding LFO to the DCO, and a Wah wah effect by adding LFO to DCF.

- VIBRATO Shape
- VIBRATO Speed
- VIBRATO Depth
- VIBRATO Pressure Depth
- LFO Shape
- LFO Speed
- LFO Delay
- LFO Depth
- LFO Pressure Depth

■ VIBRATO

An Effect which creates oscillations in pitch.

● SHAPE

(Value: TRI, SAW, SQR, RND)

Sets how the pitch is to be shaped.

```
VIBRATO    PCCP
SHAPE      =TRI
```

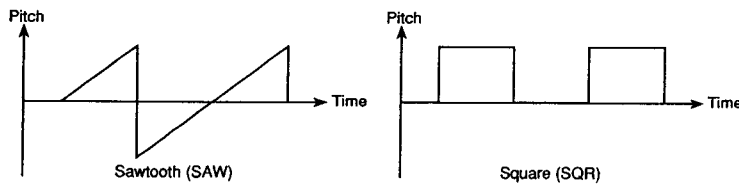

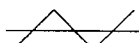
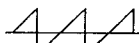
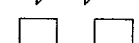
Value	Effect
TRI	 Triangle
SAW	 Sawtooth
SQR	 Square
RND	Random variation

```
VIBRATO    PCCP
SPEED      =100
```

● SPEED

(Value: 0-100)

Sets Vibrato speed.

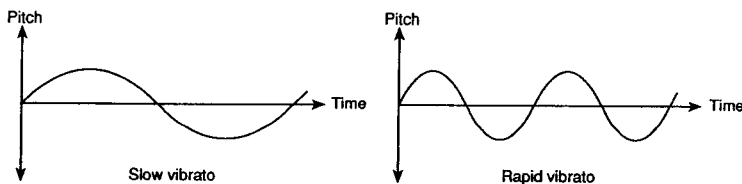

Value	Effect
0	Slow vibrato
5	
100	Rapid vibrato

```
VIBRATO PCCP
DEPTH =-50
```

● **DEPTH**

(Value: -50 to 0 to +50)

Sets the depth of change of Vibrato pitch variation. The Vibrato for each source may be turned ON and OFF with the DCO Group VIBRATO/AUTO BEND. (See P. 47)

The amount of time after a key is pressed until Vibrato takes effect can be set with COMMON Group AUTO BEND TIME. (See P. 37)

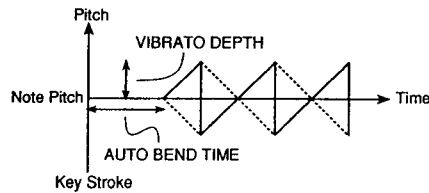

Value	Effect
+50	Maximum vibrato with normal waveform
{	}
0	No vibrato
{	}
-50	Maximum vibrato with inverted waveform

```
VIBRATO PCCP
PRESS DEPTH=-50
```

● **PRESS DEPTH**

(Value: -50 to 0 to +50)

The depth of Vibrato pitch change may be adjusted by the amount of pressure placed on the key while playing.

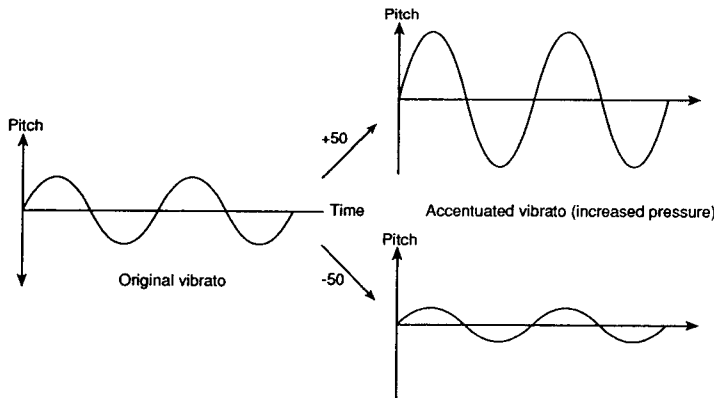

Value	Effect
+50	Increased vibrato
{	}
0	No effect
{	}
-50	Decrease vibrato

■ LFO

Varies tone according to the LFO cycle (for a LFO Modulation "Wah wah")



● SHAPE

(Value: TRI, SAW, SQR, RND)

Sets how the pitch is to be shaped.

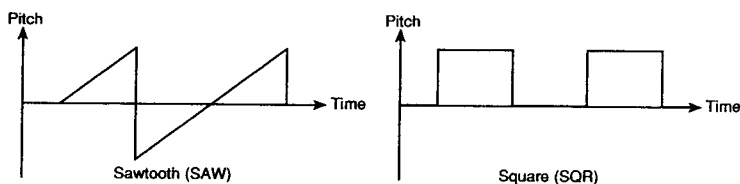
```
LFO          PCCP
SHAPE        =SAW
```

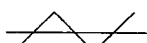
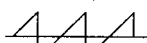

Value	Effect
TRI	 Triangle
SAW	 Sawtooth
SQR	 Square
RND	Random variation

● SPEED

(Value 0-100)

Sets LFO Modulation speed.

```
LFO          PCCP
SPEED        =100
```

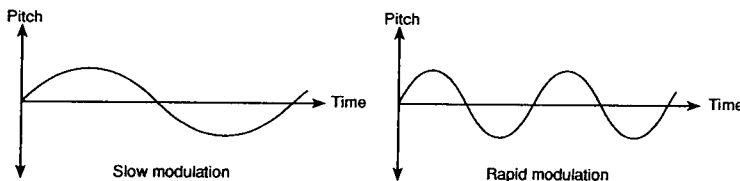

Value	Effect
0	Slow modulation
50	Medium modulation
100	Rapid modulation

● DELAY

(Value- 0-100)

Sets the amount of time before LFO Modulation takes effect after a key has been pressed.

```
LFO          PCCP
DELAY        =100
```

● DEPTH

(Value: -50 to 0 to +50)

Sets the depth of change of the LFO Modulation tone.

```
LFO          PCCP
DEPTH        =-50
```

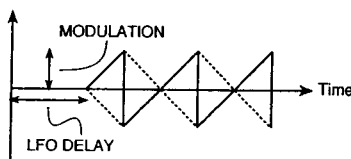

Value	Effect
+50	Maximum modulation with normal waveform
0	No modulation
-50	Maximum modulation with inverted waveform

● **PRESS DEPTH**

(Value: -50 to 0 to +50)

Depth of LFO Modulation tone change may be adjusted depending upon the amount of pressure placed on the key when playing.

```
LFO          PCCP
PRESS DEPTH=-50
```

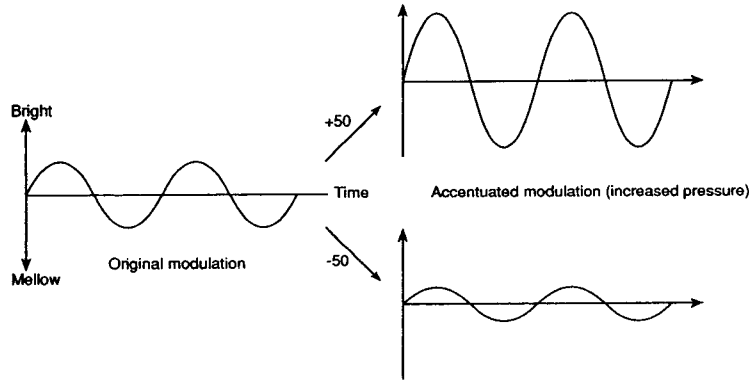

Value	Effect
+50	Increased modulation
}	}
0	No effect
}	}
-50	Decrease modulation

■ **SOURCE COMMON (S-COMMON) Group**

This sets the following parameters for each Source:

- DELAY
- VEL CURVE
- KS CURVE

● **DELAY**

(Value: 0 to 100)

This sets the time for each source from the point the key is struck to the point when attack begins.

```
S.COMMON    PCCP
DELAY       =100
```

Note: For NORMAL and DOUBLE this follows the value selected for Source 1, and for TWIN it follows the value selected for Sources 1 and 3.

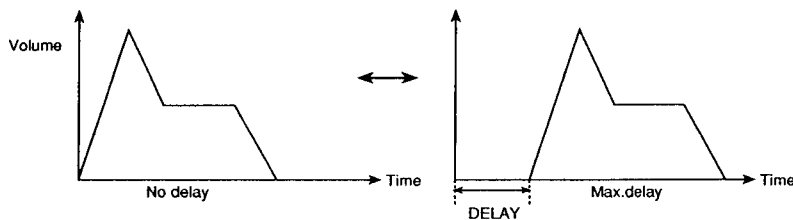

Value	Effect
0	0
}	}
100	Max. delay

■ VEL (Velocity Curve) Chart

● VEL (Velocity) CURVE

(Value: 1 to 8)

```
S.COMMON      PCCP
VEL CURVE    = 8
```

You can select the way in which volume and tone are changed by how hard the key is struck, choosing from the following eight curves.

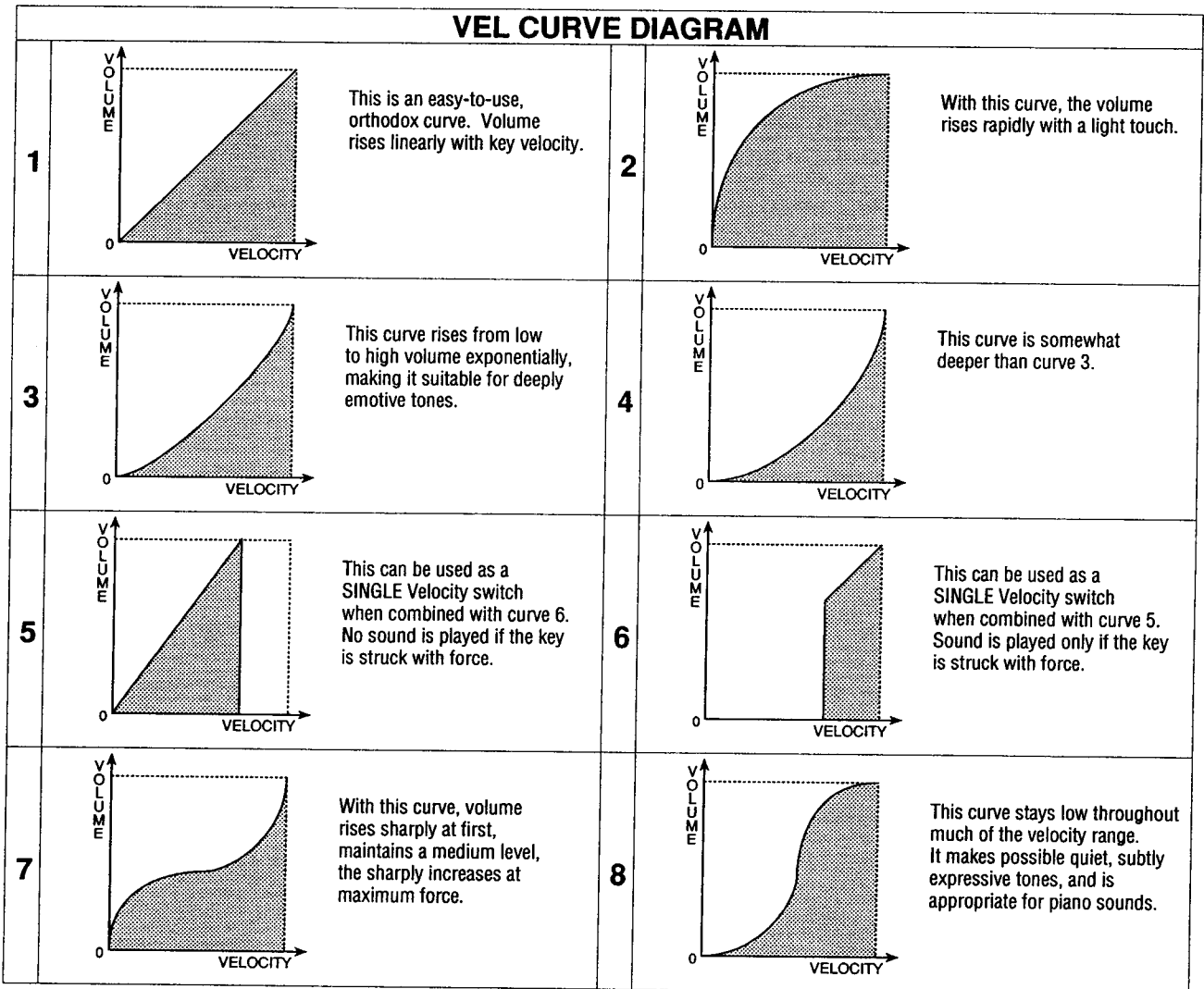

KS (Keyboard Scaling) Chart

KS (Keyboard Scaling) CURVE

(Value: 1 to 8)

This changes tone and volume according to the position of the key that is struck. You can select how these changes are made from the following eight curves.

```
S.COMMON      PCCP
KS CURVE      = 8
```

See "Editing Capabilities" on P. 57 for an explanation of how to copy.

SINGLE EDIT

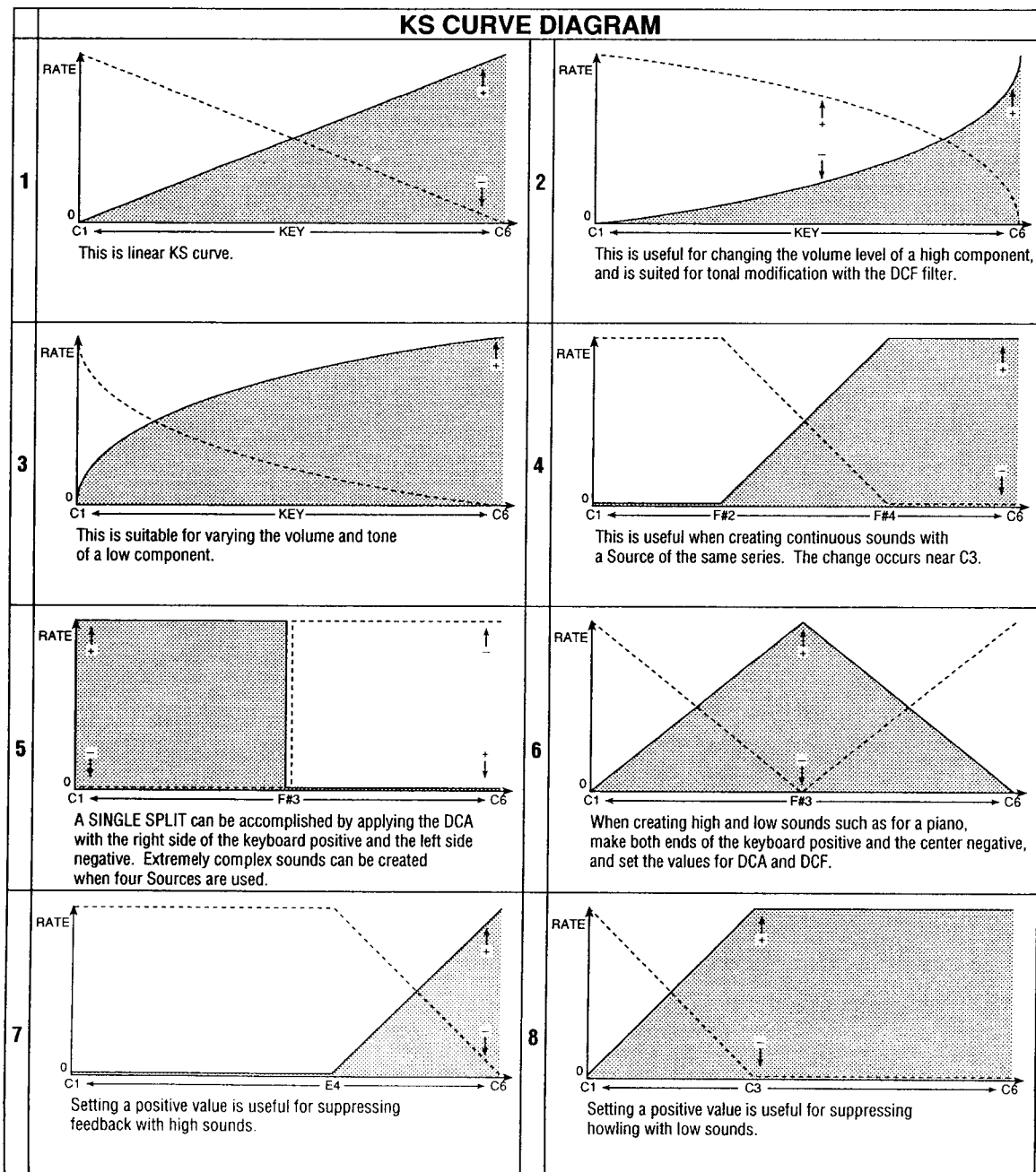

■ DCO Group

The DCO sets the values for waveform and pitch.

- WAVE
- KEY TRACK
- COARSE
- FINE
- FIXED KEY
- PRESSURE → Freq.
- VIBRATO/AUTO BEND

● WAVE

(Value: 1 to 96 (C), 97 to 256 (P))

```
DCO      PCCP
WAVE     =256
```

This selects the desired waveform for each Source from the 256 waveforms available.

See the WAVE LIST packed with the unit for available waveforms.

● KEY TRACK

(Value: ON or OFF)

```
DCO      PCCP
KEY TRACK =ON
```

This selects whether pitch is to change depending on the key struck. The keys scale normally when ON, but will be fixed at the pitch specified by FIXED KEY when OFF. (See P. 47)

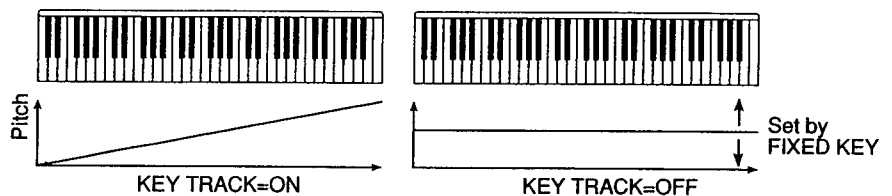

● COARSE

(Value: -24 to 0 to +24)

```
DCO      PCCP
COARSE   =-24
```

This sets the pitch of each Source in half steps. You can make settings within a range of two octaves up or down.

● FINE

(Value: -50 to 0 to +50)

```
DCO      PCCP
FINE     =-50
```

Fine tune the pitch of the Sources.

DCO	PCCP
FIXED KEY	=C -1

● FIXED KEY

(Value: C-1 to G8)

Fix the pitch of each Source to a particular pitch.

Note: This setting can only be made when KEY TRACK is OFF. (See P. 46)

DCO	PCCP
PRESS	=ON

● PRESSURE FREQUENCY

(Value: ON or OFF)

This selects whether Aftertouch will affect the pitch.

Note: This is handy for violin, sax or other solo series tones.

DCO	PCCP
VIB/A.BEND	=ON

● VIBRATO/AUTO BEND

(Value: ON or OFF)

This selects whether Vibrato and Auto Bend will affect the pitch. (See P. 40)

■ DCA Group

The DCA sets the values for volume of a sound over time.

- LEVEL
- ATTACK
- DECAY
- SUSTAIN
- RELEASE

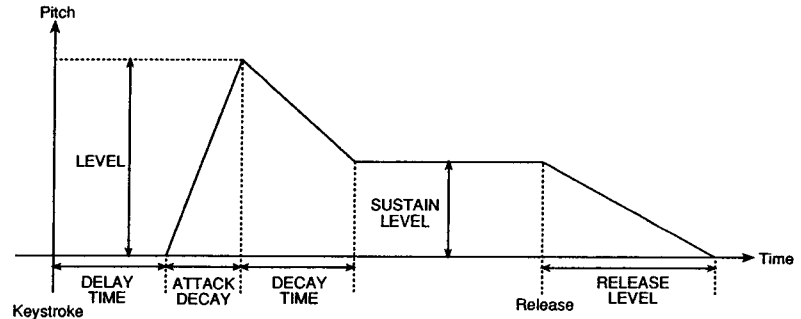

```
DCA          PCCP
LEVEL        =100
```

● LEVEL

(Value: 0 to 100)

This adjusts the initial level for each Source.

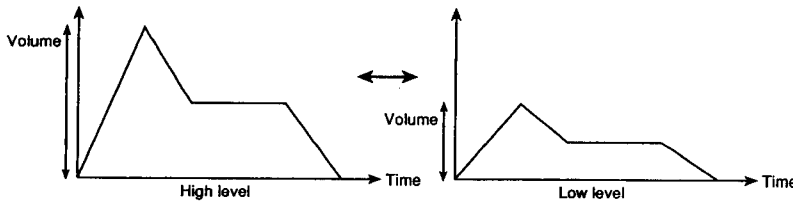

Value	Effect
0	No output (mute)
100	Maximum level

● ATTACK

(Value: 0 to 100)

This sets the time from the start of the sound until peak volume is reached (for each Source).

```
DCA          PCCP
ATTACK       =100
```

● DECAY

(Value: 0 to 100)

This sets the time from peak volume to the sustain level (for each source).

```
DCA          PCCP
DECAY        =100
```

● SUSTAIN

(Value: 0 to 100)

This sets the stable level which will be maintained as long as the key is held down (for each Source).

```
DCA          PCCP
SUSTAIN      =100
```

```
DCA          PCCP
RELEASE     =100
```

● **RELEASE**

(Value: 0 to 100)

This sets the time from the point when the key is released until the sound disappears (for each Source).

■ **DCA MODULATION (DCA MOD) Group**

The DCA MOD is used to modulate the level with the keys.

- VEL DEPTH
- PRESSURE DEPTH
- KS DEPTH
- TIME MODULATION VELOCITY
- TIME MODULATION RELEASE VELOCITY
- TIME MODULATION KS

● **VEL (Velocity) DEPTH**

(Value: -50 to 0 to +50)

This adjusts the amount of change in volume by how hard the key is struck (for each Source). Setting a negative value makes the sound quieter the harder you hit the key.

```
DCA MOD     PCCP
VEL DEPTH  =-50
```

Note: This sets the change according to the S-COMMON Velocity Curve. (See P. 44)

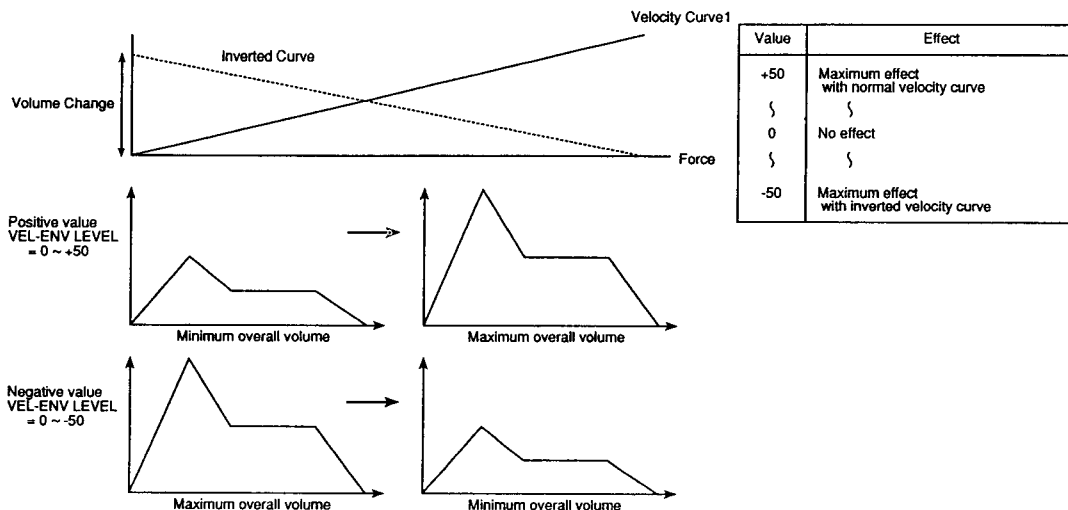

● **PRESSURE DEPTH**

(Value: -50 to 0 to +50)

This adjusts the volume according to how hard the key is pressed (for each Source). Setting a negative value makes the sound quieter the harder you press the key.

```
DCA MOD     PCCP
PRESS DEPTH=-50
```

```
DCA MOD      PCCP
KS DEPTH     =-50
```

● **KS (Keyboard Scaling) DEPTH**

(Value: -50 to 0 to +50)

This changes the volume level according to the position of the struck key (for each Source). Setting a positive value increases the volume according to the KS Curve set with S-COMMON, while a negative value will decrease the volume according to the inverse of the KS Curve. (See P. 45)

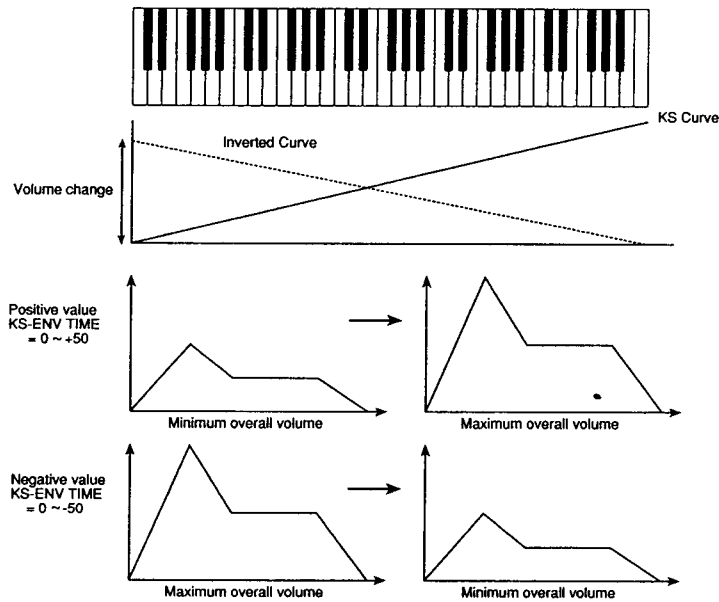

Value	Effect
+50	Maximum effect with normal KS curve
{	{
0	No effect
{	{
-50	Maximum effect with inverted KS curve

● **TIME MODULATION VELOCITY (VEL)**

(Value: -50 to 0 to +50)

```
TIME MOD     PCCP
VEL          =-50
```

This controls the envelope time according to how hard the key is struck (for each Source). Setting a positive value changes the attack according to the Velocity Curve set with S-COMMON, while a negative value will change the attack according to the inverse of the Velocity Curve. (See P. 44)

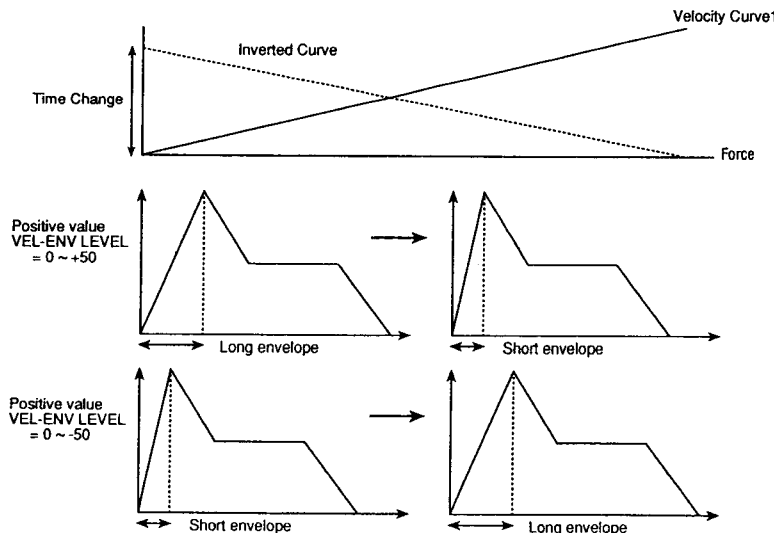

Value	Effect
+50	Maximum effect with normal velocity curve
{	{
0	No effect
{	{
-50	Maximum effect with inverted velocity curve

```
TIME MOD      ECCP
RELEASE VEL=-50
```

● TIME MODULATION RELEASE VELOCITY

(Value: -50 to 0 to +50)

This adjusts the release time according to how hard the key is struck (for each Source).

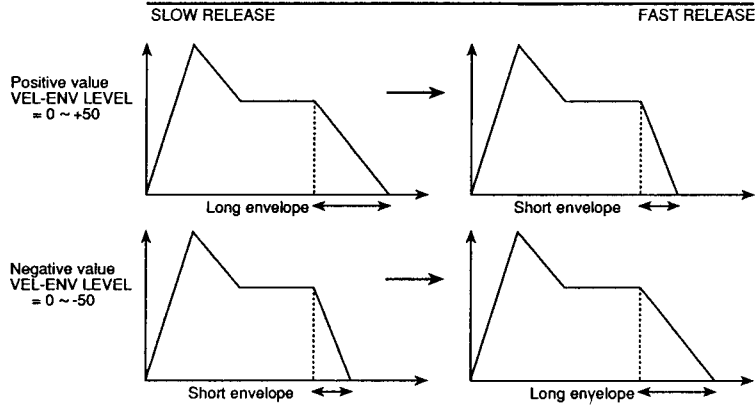

```
TIME MOD      ECCP
KS            =-50
```

● TIME MODULATION KS

(Value: -50 to 0 to +50)

This changes the attack and decay times of the envelope according to the position of the key struck (for each Source). Setting a positive value makes these changes according to the KS Curve set with S-COMMON, while a negative value will make changes according to the inverse of the KS Curve. (See P. 45)

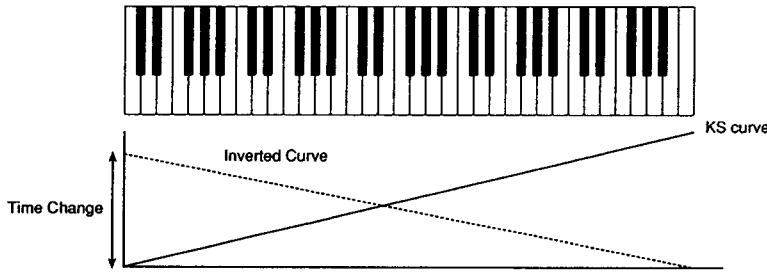

Value	Effect
+50	Maximum effect with normal KS curve
{	{
0	No effect
{	{
-50	Maximum effect with inverted KS curve

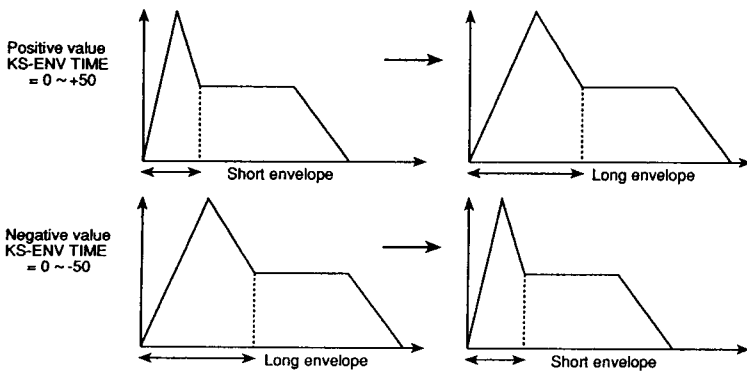

■ DCF Group

The DCF sets the values for the tone filter.

- CUTOFF
- RESONANCE
- VELOCITY DEPTH
- PRESSURE DEPTH
- KS DEPTH
- LFO

Note: When in the TWIN Source mode, select the Filter by pressing a Source Select (1 to 4). You can select the Filters for Sources 1 and 2 with switches 1 and 2, and the Filters for Sources 3 and 4 with switches 3 and 4.

● CUTOFF

(Value: 0 to 100)

```
DCF          PCCF
CUTOFF      =100
```

The basic function is the same as an analog Low Pass Filter. A tone generator waveform containing many harmonics is adjusted by a Low Pass Filter, which cuts off all harmonics above a specified Cutoff value. The higher this value is, the more brilliant the sound.

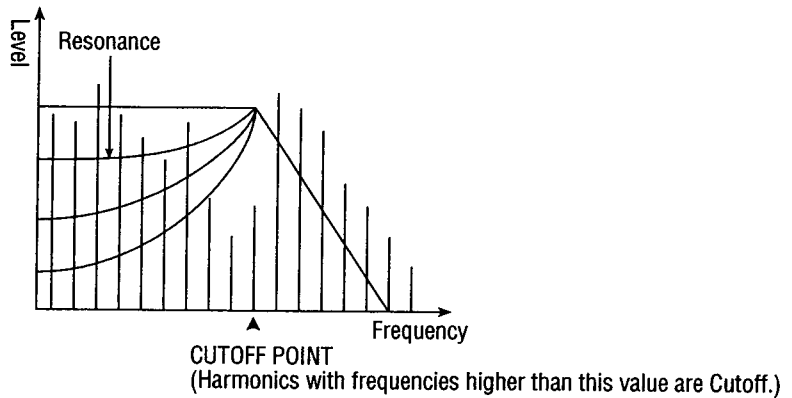

Note: No sound will be played if you set this value too low.

DCF	PCCP
RESONANCE	= 7

● RESONANCE

(Value: 0 to 3 (NORM, TWIN), 0 to 7 (DBL))

This sets the level near the Cutoff Frequency. The larger you set this value, the more emphasis is given to the particular harmonic, resulting in a sharp, ringing tone.

Note: Especially sharp timbres can be created in the DOUBLE Source mode. The tone will be distorted if you set this value too high.

DCF	PCCP
VEL DEPTH	= -50

● VELOCITY DEPTH (VEL DEPTH)

(Value: -50 to 0 to +50)

This adjusts the amount Velocity Modulation of the filter Cutoff Frequency. Setting a positive value makes the sound brighter the harder the key is struck. Setting a negative value makes the sound less brilliant the harder the key is struck. (See P. 44)

DCF	PCCP
PRESS DEPTH	= -50

● PRESSURE DEPTH

(Value: -50 to 0 to +50)

This adjusts the Cutoff according to how hard the key is pressed. Setting a positive value makes the sound brighter the harder you press the key. Setting a negative value makes the sound less brilliant the harder you press the key.

DCF	PCCP
KS DEPTH	= -50

● KS DEPTH

(Value: -50 to 0 to +50)

This changes the Cutoff according to the position of the struck key. Setting a positive value changes the tone according to the KS Curve set with S-COMMON, while a negative value will change the tone according to the inverse of the KS Curve. (See P. 45)

Note: For NORMAL and DOUBLE this is according to the KS Curve selected for Source 1, and for TWIN this is according to the KS Curve selected for Sources 1 and 3.

DCF	PCCP
LFO	= ON

● LFO

(Value: ON or OFF)

This selects whether the Cutoff Frequency will be modulated by the LFO. The speed of tone oscillation is set with the LFO. (See P. 40)

■ DCF MODULATION (DCF MOD) Group

These settings are used when changing the tone with an envelope (temporal change). The Cutoff Point set for DCF is taken as a standard (Level 0) for making changes in level over time.

- ENVELOPE DEPTH
- VELOCITY DEPTH
- ATTACK
- DECAY
- SUSTAIN
- RELEASE
- TIME MODULATION VELOCITY
- TIME MODULATION RELEASE VELOCITY
- TIME MODULATION KS

When in the TWIN Source mode, select the Filter by pressing a Source Select (1 to 4) in the same way as you did for editing with the DCF. You can select the Filters for Sources 1 and 2 with switches 1 and 2, and the Filters for Sources 3 and 4 with switches 3 and 4.

Note: For NORMAL and DOUBLE this is according to the Delay, Velocity Curve and KS Curve selected for Source 1, and for TWIN this is according to the Delay, Velocity Curve and KS Curve selected for Sources 1 and 3.

● ENVELOPE DEPTH

(Value: -50 to 0 to +50)

DCF MOD	PCCP
ENU DEPTH	=-50

This sets the amount of Cutoff Modulation by the DCF's envelope. Setting a positive value raises the Cutoff Frequency as the level of the envelope curve becomes higher, for a brighter sound. Setting a negative value lowers the Cutoff Frequency as the level of the envelope curve becomes higher, for a less brilliant tone.

```
DCF MOD      PCCP
VEL DEPTH    =-50
```

● VELOCITY DEPTH (VEL DEPTH)

(Value: -50 to 0 to +50)

This controls the envelope level according to how hard the key is struck. The change is according to the Velocity Curve set for S-COMMON. (See P. 44)

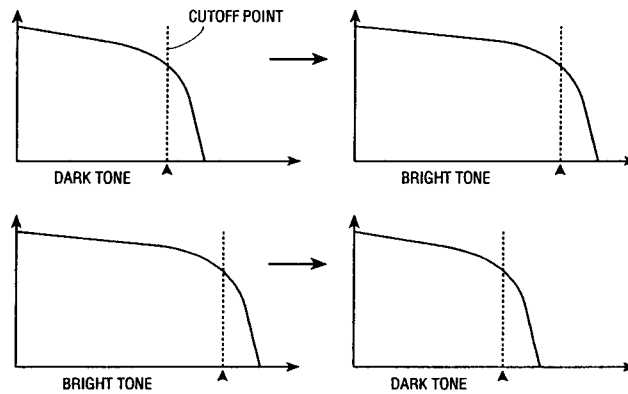

```
DCF MOD      PCCP
ATTACK       =100
```

● ATTACK

(Value: 0 to 100)

This sets the speed of the envelope attack. The larger the value, the slower the tone will change.

```
DCF MOD      PCCP
DECAY        =100
```

● DECAY

(Value: 0 to 100)

This sets the time until the attack level drops to a sustained Cutoff Frequency level.

```
DCF MOD      PCCP
SUSTAIN      =-50
```

● SUSTAIN

(Value: 0 to 100)

This sets the Cutoff Frequency level which will be maintained until the key is released.

```
DCF MOD      PCCP
RELEASE      =100
```

● RELEASE

(Value: 0 to 100)

This sets the time from the point when the key is released until the envelope level drops to zero. If the key is released before the tone rises to the Sustain level, the level will dwindle to zero from its current value at the time set for Release.

● **TIME MODULATION VELOCITY (ATTACK)**

(Value: -50 to 0 to +50)

```
TIME MOD   PCCP
VEL        =-50
```

This adjusts the attack time according to how hard the key is struck. Setting a positive value changes the attack according to the Velocity Curve set with S-COMMON, while a negative value will change the attack according to the inverse of the Velocity Curve. (See P. 44)

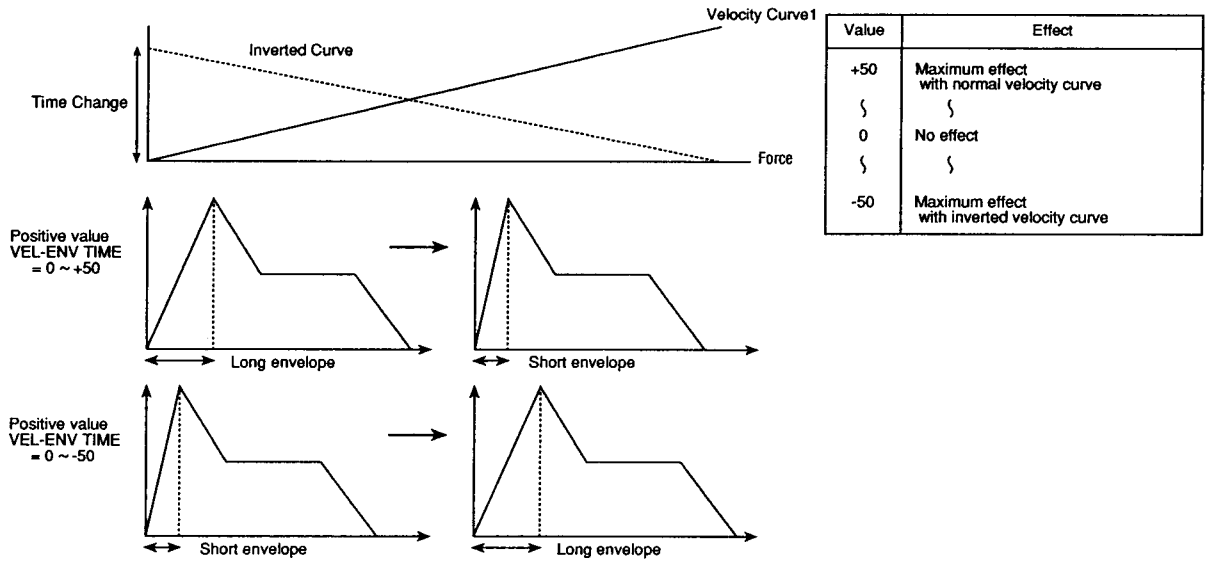

● **TIME MODULATION RELEASE VELOCITY**

(Value: -50 to 0 to +50)

```
TIME MOD   PCCP
RELEASE VEL=-50
```

This adjusts the release time according to how fast the key is released.

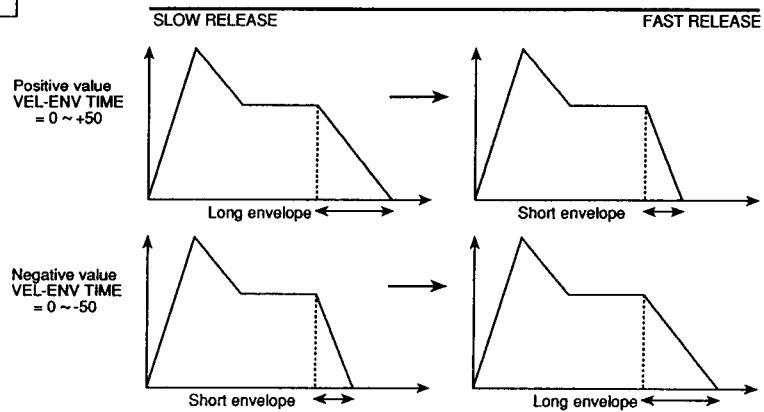

● **TIME MODULATION KS**

(Value: -50 to 0 to +50)

```
TIME MOD   PCCP
KS         =-50
```

This changes the attack and decay times of the envelope according to the position of the key struck. Setting a positive value makes these changes according to the KS Curve set with S-COMMON, while a negative value will make changes according to the inverse of the KS Curve. (See P. 45)

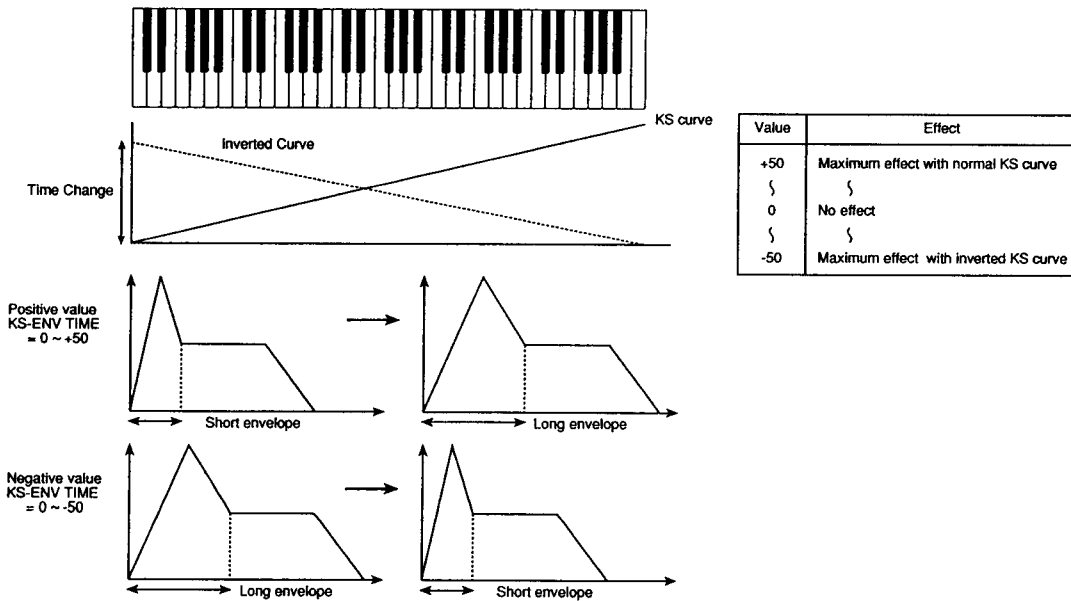

■ **Editing Capabilities**

The COPY function is a handy shortcut if there is a Source or Filter similar to the one you want to use in a different patch or even the current patch. First of all, select the patch containing the Source or Filter you want to use.

<Procedure>

```
COPY       PCCP
FROM SINGLE=IA-16
```

- (1) Press the **6** S-COMMON several times until the PATCH SELECT display is displayed.
- (2) Select the patch with the VALUE Slider or **+ YES** and **- NO**.
- (3) Next, select the Source or Filter that you want to copy. Values are as follows.

- S1: Copy the entire contents of Source 1.
- ⋮
- S4: Copy the entire contents of Source 4.
- ⋮
- F1: Copy the entire contents of Filter 1.
- F2: Copy the entire contents of Filter 2.

Note: The COPY function copies from a patch as stored in memory. If you want to copy a Source or Filter from a patch being edited, write it to memory before performing the COPY.

```
COPY          PCCP
FROM SOURCE=S1
```

<Procedure>

(1) Press the several times until SOURCE SELECT is displayed.

(2) Select the Source or Filter with the VALUE Slider.

```
COPY          PCCP
FROM EXEC?=Y/N
```

(3) The message "EXEC?" will then appear. Press to copy or to cancel.

```
COPY          PCCP
FROM SURE?=Y/N
```

(4) If you pressed in step (3), the message "SURE?" will appear to ask you for confirmation. Press to copy or to cancel.

■ Writing a SINGLE Patch

This is done to store the edited patch in memory.

If you write the data any data previously stored will be written over. Save patches you don't want to lose on the optionally available card (DC-16), or store it in a computer or sequencer such as the Q-80 using the MIDI DATA DUMP. (See P. 82)

```
RECALL
```

Note: Press the if you mistakenly leave the EDIT mode. The screen shown left will be displayed, and you can return to the mode you left by pressing the .

<Procedure>

Note: First of all, turn off the PROTECT for the unit (or card) so that writing can be done.

```
INTERNAL
PROTECT      =OFF
```

(1) While in the SINGLE EDIT mode, press the several times to display the PROTECT screen.

```
CARD
PROTECT      =ON
```

(2) Press the to turn off the PROTECT.

(3) Press the several times to display the WRITE screen.

```
TONE WRITE
TO          =IA-1
```

- (4) Use the VALUE Slider or the and to select the number of the patch to be written, and then press the .
- (5) The message "EXEC?" will then appear. Press to execute writing or to cancel.

```
TONE WRITE SIA-1
TO          EXEC?=Y/N
```

- (6) If you pressed in step (5), the message "SURE?" will appear to ask you for confirmation. Press to execute writing or to cancel.
- (7) Press the several times to display the PROTECT screen, and then turn the PROTECT switch back on.

Note: A new card must be formatted before it can be written to (P. 26).

2-6. Editing a MULTI Patch

1. MULTI Patch Configuration

A MULTI Patch is a combination of up to eight SINGLE Patches. A MULTI Patch is divided into Sections which each consist of a SINGLE Patch plus various parameters that tie sound generation to Key Velocity, Keyboard Range, MIDI Channel, Tuning, Transposition, Level, and Output to play various sounds using the keyboard or MIDI.

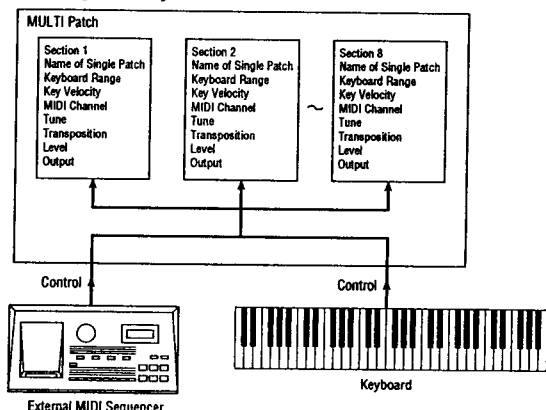

2. Using MULTI Patches

MULTI Patches have no parameters for creating tones – MULTI Patch parameters are used to set how the tone of each Section is to be played. A number of tones can be played at the same time by setting all parameters but the tone name to the same values. A Velocity switch, where a different tone is played depending on how hard the key is struck, can be created by changing only the Velocity value. A detuned effect can be obtained by varying the pitch by a slight amount. Many tones can be played independently from a sequencer or computer by setting each to a different MIDI channel. By manipulating the MULTI Patch settings in this way, you can add a wide variety of effects to your performances.

3. Choosing a Section to Edit

This is used when editing Sections individually.

<Procedure>

- (1) Select the Section to be edited with the Section Select keys (1 through 8).

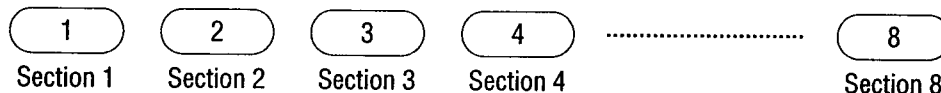

- (2) If you want to listen to the Section sounds individually, press the appropriate Section Mute (9 through 16) to temporarily cancel the sound of the other Sections.

■ Display During Editing

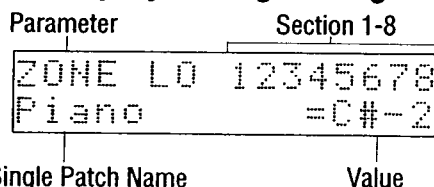

1-16: The MIDI channel of each Section
 -: Muted Section

4. Editing Section Parameters

■ EDIT Group

Sets common Section parameters.

- VOLUME
- EFFECT (K4)/OUTPUT (K4r) Patch
- NAME

```
MIA-1  Q R S T U V W X Y Z
VOLUME      = 100
```

- **VOLUME**

(Value: 0 to 100)

This controls the volume of the entire MULTI Patch. Adjust the differences in volume between patches so that there is no unnatural change in loudness when patches are switched.

```
MIA-1  Q R S T U V W X Y Z
EFFECT PACH= 32
```

- **EFFECT Patch (OUTPUT Patch)**

(Value: 1-32)

Select the EFFECT to be used from the 32 EFFECT Patches previously set (K4 only – OUTPUT Setting is used on the K4r). (See P. 24, 71)

```
MIA-1  Q R S T U V W X Y Z
OUTPUT PACH= 32
```

- **NAME (1st through 10th)**

Name the edited MULTI Patch. Up to 10 characters can be utilized, in the same way as for SINGLE Patches.

```
MIA-1  Q R S T U V W X Y Z
NAME      1st= Q
```

■ INST Group

Select the SINGLE Patches to be used in the Sections.

- **SINGLE Patch Selection**

- **SINGLE**

(Value: INT – IA-1 to ID-16, EXT – EA-1 to ED-16)

Select SINGLE Patches.

Note: The unit's internal MULTI Patches cannot use SINGLE Patches on the cards. Similarly, the card's MULTI Patches cannot use the machine's internal SINGLE Patches.

```
SINGLE  2180359104
Piano  = IA-1
```

Use the VALUE Slider or YES and NO to select the SINGLE Patch. Switches A through D are used to select the EDIT parameters, and 1 through 16 are used to select Sections and for muting.

Note: Since SINGLE tones used in a MULTI Patch are controlled by patch numbers, changing the contents of a SINGLE Patch will also change the sound within the MULTI Patch.

■ ZONE Group

This sets the range for each Section.

- ZONE LO
- ZONE HI
- VEL SW

● ZONE LO/HI

(Value: C-2 to G8)

Set the upper and lower limits for the tone range of the Sections.

```
ZONE LO 218-59104
Piano    =C#2
```

```
ZONE HI 2181359104
Piano    =G 4
```

Note: Setting ZONE LO to a higher value than ZONE HI causes the middle range to be silent, with both the upper and lower ends played.

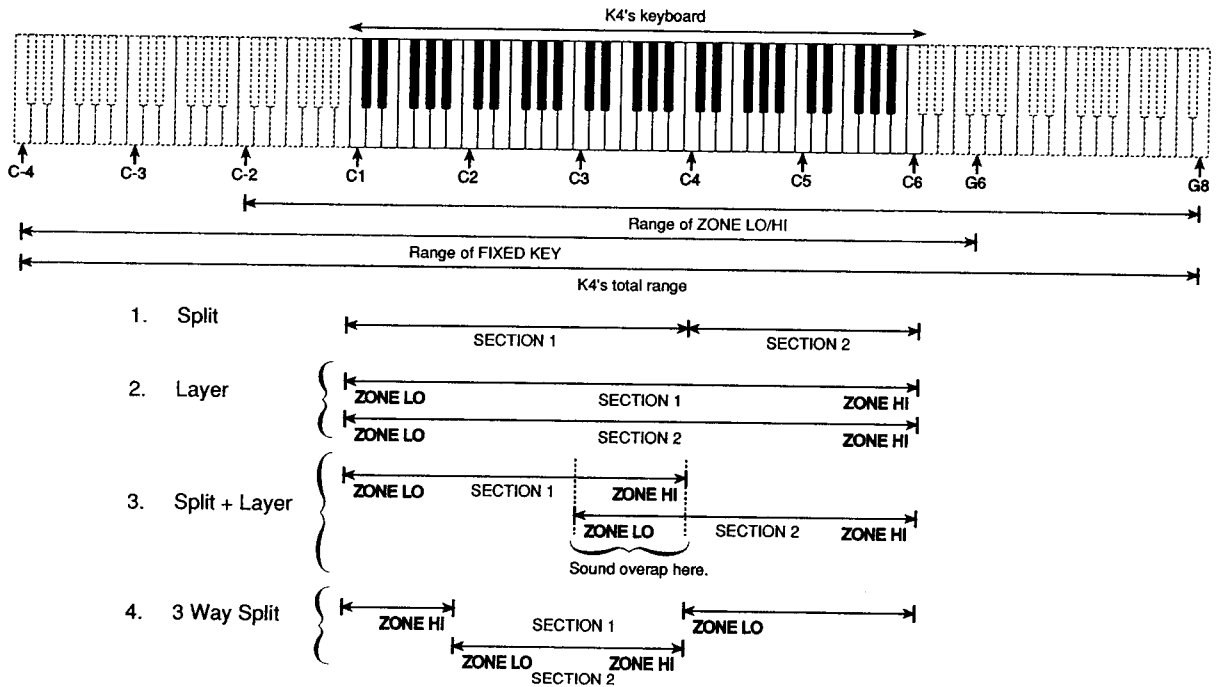

● **VEL SW (Velocity Switch)**

(Value: SOFT, LOUD, or ALL)

You can switch tones according to how hard you hit the keys (Velocity switch) by changing this setting for the Sections.

```
VEL SW  2181359104
Piano   =LOUD
```

Notes: *SOFT: Played only when keys are lightly struck*
LOUD: Played only when keys are struck heavily
ALL: Played under all conditions

The velocity switch point at which switching between SOFT and LOUD takes place is set using SYSTEM/VEL SW POINT. (See P. 77)

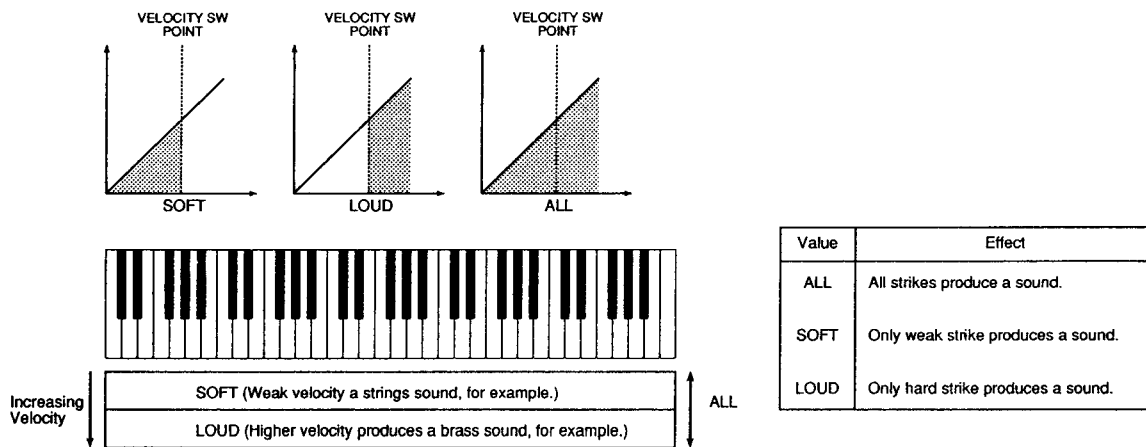

■ **SEC Ch (Section Channel) Group**

Set the MIDI channels for the Sections.

- RCV Ch
- PLAY Mode

● **RCV Ch (Receiving channel)**

(Value: 1 through 16)

Set the MIDI receiving channel for each Sections.

```
RCV CH  2181359104
Piano   = 2
```

● **PLAY Mode**

(Value: KYBD, MIDI, MIX)

Sets the section to play from the keyboard (KYBD), from MIDI, or both (MIX).

```
MODE    2181359104
Piano   =MIDI
```

■ LEVEL Group

Set the level and other parameters for Sections.

- LEVEL
- TRANSPOSE
- TUNE
- SUBMIX CH

LEVEL	2181359104
Piano	=100

● LEVEL

Value: 0 through 100)

Set the level for each Section.

TRANS	2181359104
Piano	= -24

● TRANSPOSE

(Value: -24 to 0 to +24)

This transposes the pitch of the Sections up or down in half steps. By layering a Section in normal pitch with Sections transposed by five and 12 half steps, you can play harmonies in a fifth and a full octave with one finger.

Settings can be made within a range of two octaves.

Note: TRANSPOSE does not effect SINGLE Patches with the DCO key track OFF.
(See P. 46)

TUNE	2181359104
Piano	= -50

● TUNE

(Value: -50 to 0 to +50)

This performs fine tuning for Section pitches. You can create a thicker sound by slightly varying the pitch of several Sections with the same tone.

Settings can be made within a range of one half tone.

SUBMIX	2181359104
Piano	= H

● SUBMIX CH

(Value: A through H)

Within an EFFECT or OUTPUT Setting, you can set eight types of SUBMIX CHes which determine the level of the effect and the orientation of the sound image.

Here, the mode to be used by each Section is selected from among these eight settings. (See P. 24, 71)

■ Writing MULTI Patches

Save the edited patch in memory.

RECALL

Notes: Press the **RECALL** if you mistakenly leave the EDIT mode. The screen shown left will be displayed, and you can return to the mode you left by pressing the **EDIT**.

If you write the data any data previously stored will be written over. Save patches you don't want to lose on the optionally available card (DC-16), or store them in a computer or sequencer such as the Q-80 using the MIDI DATA DUMP. (See P. 27, 82)

Make sure that the PROTECT is OFF, and perform the following procedure.

<Procedure>

TONE WRITE
TO =IA-1

- (1) Press the **WRITE** to display the following screen.
- (2) Select the number of the patch you want to write with the VALUE Slider, and press **WRITE**.
- (3) The message "EXEC?" will then appear. Press **+ YES** to execute writing or **- NO** to cancel.
- (4) If you pressed **+ YES** in step (3), the message "SURE?" will appear to ask you for confirmation. Press **+ YES** to execute writing or **- NO** to cancel. If necessary, set the PROTECT to ON.

Note: A new card must be formatted before it can be written to. (See P. 26)

2-7. Editing Sounds for the DRUM Section

1. DRUM Section Configuration

The DRUM Section is a tone generator Section for rhythm which is different from the tone generator for SINGLE and MULTI Patches. A set of 61 patches, one for each key C1 through C6 (MIDI note numbers 36 through 96) can be programmed and played simultaneously with the SINGLE and MULTI Patches. The DRUM Section is also programmed on the card and either the internal or external one can be used. The maximum number of notes that can be played at the same time, including SINGLE and MULTI Patches, is 16.

```

DRUM          C 6
WAVE         S1  =256
    
```

The DRUM Section utilizes two Sources for each key, and settings for Wave, Decay, Tune, and Level can be made for each Source.

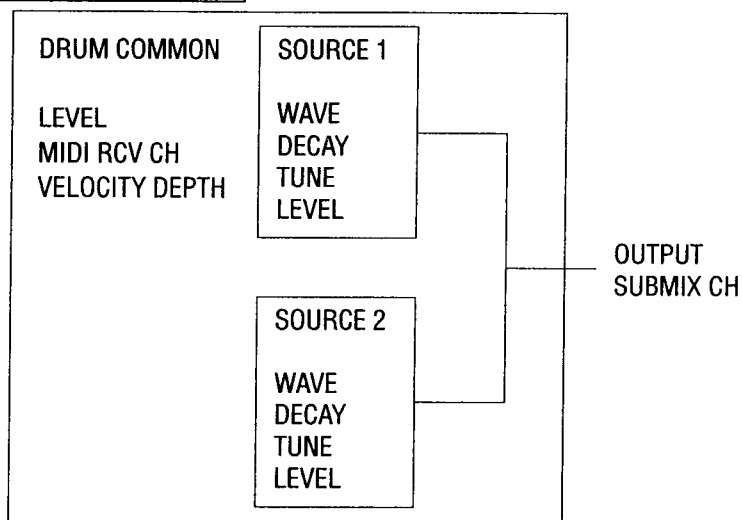

Note: The EFFECT and SUBMIX CH Settings for the DRUM Section use the EFFECT Settings for the currently selected SINGLE or MULTI Patch (K4 only – OUTPUT values Stereo L R, 1 ~ 6 are used for the K4r).

■ EDIT Screen

DRUM	C 6
WAVE S1	=256
Parameter	Value

Selected Key

■ EDIT Procedure

Common Parameters

● VOLUME

(Value: 0 to 100)

DRUM	
VOLUME	=100

This controls the volume of the entire DRUM Section. Adjust the differences in volume for SINGLE Patch and MULTI Patch Sections so that there is no unnatural change in loudness when the DRUM Section is called up.

Note: The  also works during DRUM EDIT to allow the sound being created to be compared with the sound before editing.

● MIDI RCV Ch (Receiving channel)

(Value: 1 through 16)

DRUM	
RCV CH	= 10

Set the MIDI receiving channel for the DRUM Section.

Note: This is independent of the OMNI ON/OFF for SYSTEM/MIDI. (See P. 79)

● VEL (Velocity) DEPTH

(Value: -50 to 0 to +50)

DRUM	
VEL DEPTH	=+23

Sets the depth of level change according to how hard the key is struck.

2. Creating DRUM Section Tones

DRUM	C 6
KEY	=C 6

● KEY

(Value: C1 to C6)

Designate the keys to be set.

Note: The key to be set can also be selected by pressing the desired key directly, in any of the DRUM Section EDIT screens.

DRUM	C 6
WAVE S1	=256

● WAVE S1 and S2

(Value: 1 through 256)

Designate the WAVES for Sources 1 and 2.

Note: The same waveforms available for SINGLE Patches (1 to 256) can be used.

DRUM	C 6
WAVE S2	=256

● DECAY S1 and S2

(Value: 1 to 100)

Set the DECAY for Sources 1 and 2.

DRUM	C 6
DECAY S1	=100

DRUM	C 6
DECAY S2	=100

● TUNE

(Value: -50 to 0 to +50)

Adjust the pitch of the Sources. Settings can be made within a range of one octave up or down.

DRUM	C 6
TUNE S1	=-50

DRUM	C 6
TUNE S2	=-50

● LEVEL

(Value: 0 to 100)

Adjust the volume levels for the Sources.

DRUM	C 6
LEVEL S1	=100

DRUM	C 6
LEVEL S2	=100

● SUBMIX CH

(Value: A to H)

Within an EFFECT (OUTPUT) Setting, you can set eight types of SUBMIX CHes which determine the level of the effect and the orientation of the sound image. Here, the SUBMIX CH to be used as the instrument (DRUM) to be allotted to each key is selected from among these eight settings. (See P.24, 71)

DRUM	C 6
SUBMIX CH	= H

● COPY

(Value: C1 to C6)

You can copy the settings made from another other key. For example, to create a tomtom sound that is identical with another setting except for pitch, you can skip the trouble of creating the second setting from scratch by copying the first one and changing only the pitch.

```
COPY      C 6
FROM      KEY=C 1
```

<Procedure>

- (1) Select the key to be copied to (by pressing it).
- (2) Press the **DRUM** several times to display the COPY screen.
- (3) Select the key you want to copy by pressing it, and then press the **DRUM**.
- (4) The message "EXEC?" will then appear. Press **+YES** to copy or **-NO** to cancel.
- (5) If you pressed **+YES** in step (4), the message "SURE?" will appear to ask you for confirmation. Press **+YES** to copy or **-NO** to cancel.

3. Writing the DRUM Section to memory

Save the edited DRUM Section in memory.

Note: If you write the data any data previously stored will be written over. Save DRUM Section data you don't want to lose on the optionally available Card (DC-16), or store it in a computer or sequencer such as the Q-80 using the MIDI DATA DUMP. (See P. 82)

<Procedure>

Note: Make sure that the PROTECT is OFF, and perform the following procedure.

```
DRUM WRITE
TO           =INT
```

(1) Press the to display the following screen.

```
DRUM WRITE
EXEC?=Y/N
```

(2) Select INT (internal) or EXT (card) with the VALUE Slider or and , and then press the .

(3) The message "EXEC?" will then appear. Press to execute writing or to cancel.

```
DRUM WRITE
SURE?=Y/N
```

(4) If you pressed in step (3), the message "SURE?" will appear to ask you for confirmation. Press to execute writing or to cancel.

Note: If necessary, set the PROTECT to OFF.

A new card must be formatted before it can be written to (See P. 26).



```
COMPLETED!
```

```
CANCELED!
```

2-8. EFFECT (K4) and OUTPUT (K4r) Settings

1. EFFECT Patches (K4 only)

The K4 can store 32 EFFECT Patches internally and 32 more on a card. An EFFECT Patches can be selected as any one of the 16 DIGITAL EFFECTS of the K4 and added to the desired tone.

In addition to this, eight types of SUBMIX CHes can be stored for an EFFECT Patches. The Stereo Orientation (PAN) and Level of the Effect (EFFECT SEND) are stored for each SUBMIX CH (PAN only for the K4r).

Selecting an EFFECT Setting for a SINGLE Patch means to specify which EFFECT will be applied to the patch, and selecting the SUBMIX CHes for an EFFECT Setting means to specify the Level of the Effect as well as its sound image orientation.

PAN and EFFECT DEPTH can be selected as desired for each SUBMIX CH. You can select only one EFFECT Setting for an entire MULTI Patch, but you can set a SUBMIX CH for each of the Sections (1 through 8).

The EFFECT and SUBMIX CH Settings for the DRUM Section use the EFFECT Settings for the currently selected SINGLE or MULTI Patch (K4 only – OUTPUT values are used for the K4r).

2. OUTPUT Patches (K4r only)

While the K4r has no EFFECTS, it is equipped with six independent OUTPUT jacks as well as left and right Stereo jacks (the K4 has only left and right Stereo jacks). The OUTPUT Patch is where data on how SINGLE Patches, MULTI Patches, and the DRUM Section are connected to these eight output jacks is stored. The only parameter within SUBMIX CHes is PAN. The K4r can be used in the same way as the K4.

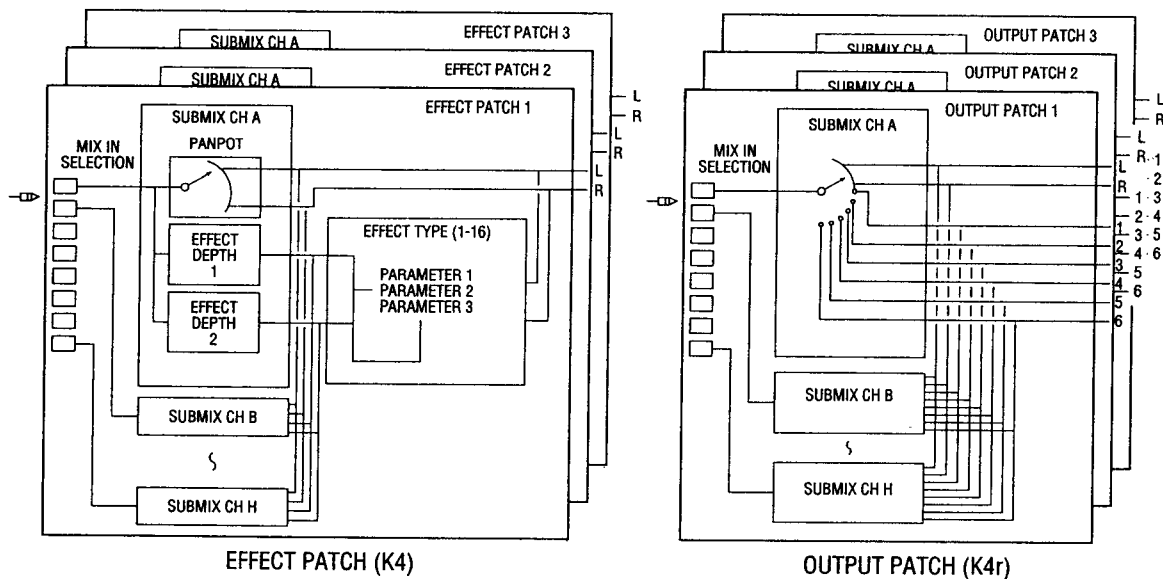

Note: By using headphones, you can monitor the sound of the right and left outputs, although the Individual Outputs (1–6) can not be heard. (K4r)

With VOLUME Slider, you can control the output level of the R/MONO, & L and PHONES outputs. The Individual Outputs are not affected. (K4r)

3. Programming Parameters

<Procedure>

```
SIA-1 ABCDEFGHIJ
EFFECT PACH= 32

MIA-1 ABCDEFGHIJ
OUTPUT PACH= 32
```

- (1) Select the EFFECT (K4) or OUTPUT (K4r) Setting while in the SINGLE or MULTI EDIT mode. (See P. 33, 61)
- (2) Press the **EFFECT** (or **OUTPUT** for the K4r).

● **EFFECT TYPE (K4 only)**

(Value: 1 to 16)

Set which of the 16 built-in DIGITAL EFFECTS is to be used.

<Procedure>

```
EFFECT PACH 32
TYPE          = 1
```

- (1) Press the **EFFECT** several times to display the EFFECT TYPE Setting screen.
- (2) Make the setting using the VALUE Slider or the **+YES** and **-NO**.

● **Parameters 1 to 3 (See P. 92')**

EFFECT No.	EFFECT NAME	PARAMETER 1	VALUE	PARAMETER 2	VALUE	PARAMETER 3	VALUE
1.	REVERB 1	PRE.DELAY		REV.TIME		STONE	
2.	REVERB 2	PRE.DELAY		REV.TIME		STONE	
3.	REVERB 3	PRE.DELAY		REV.TIME		STONE	
4.	REVERB 4	PRE.DELAY		REV.TIME		STONE	
5.	GATE REVERB	PRE.DELAY		GATE TIME		STONE	
6.	REVERSE GATE	PRE.DELAY		GATE TIME		STONE	
7.	Normal DELAY	FEED BACK		STONE		DELAY	
8.	Stereo PANPOT DELAY	FEED BACK		L/R DELAY		DELAY	
9.	CHORUS	WIDTH		FEED BACK	0-7	RATE	0-30
10.	OVER DRIVE+ FLANGER	DRIVE	0-7	FL.TYPE	0-7	1 + 2 BAL	0-30
11.	OVER DRIVE- Normal DELAY	DRIVE		DELAY TIME		1 + 2 BAL	
12.	OVER DRIVE+ REVERB	DRIVE		REV.TIME		1 + 2 BAL	
13.	Normal DELAY+ Normal DELAY	DELAY1		DELAY2		1 + 2 BAL	
14.	Normal DELAY+ Stereo Pan.DELAY	DELAY1		DELAY2		1 + 2 BAL	
15.	CHORUS+ Normal DELAY	CHORUS		DELAY		1 + 2 BAL	
16.	CHORUS+ Stereo Pan.DELAY	CHORUS		DELAY		1 + 2 BAL	

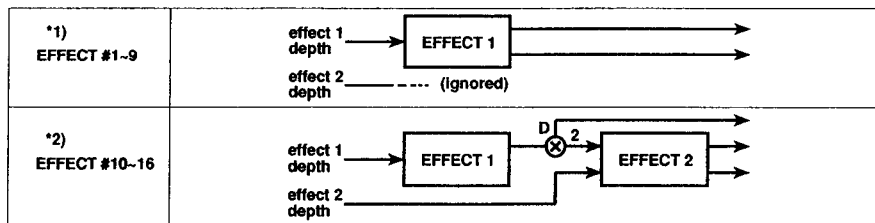

**1→2 BAL* in PARAMETER 3 controls the balance between the sound passing through only Effect 1 and the sound passing through both Effect 1 and 2.

```
EFFECT PACH 32
PRE.DELAY = 7
```

<Procedure>

- (1) Press the **EFFECT** several times to display the EFFECT Parameter Setting screen.
- (2) Make the Setting using the VALUE Slider or the **+YES** and **-NO**.

● SUBMIX CH EDIT

(Value: A through H)

Select the SUBMIX CH to be edited. (See P. 24, 71)

(OUTPUT)

```
EFFECT PACH  32
SUBMIX EDIT=  H
```

<Procedure>

- (1) Press the **EFFECT** several times to display the SUBMIX CH Select screen (K4 only – use the **OUTPUT** on the K4r).
- (2) Select with the VALUE Slider or the **+YES** and **-NO**.
- (3) Repeat steps (1) and (2) is you want to edit other SUBMIX CHes.

● PAN

(Value: -7 (Right) to 0 (Center) to +7 (Left), INDIV 1 to INDIV 6 [K4r])

Note: Determine the sound image orientation of the tone using the SUBMIX CH. When you use the K4r's card on K4, the patches assigned INDIV1 through INDIV6 are output from center.

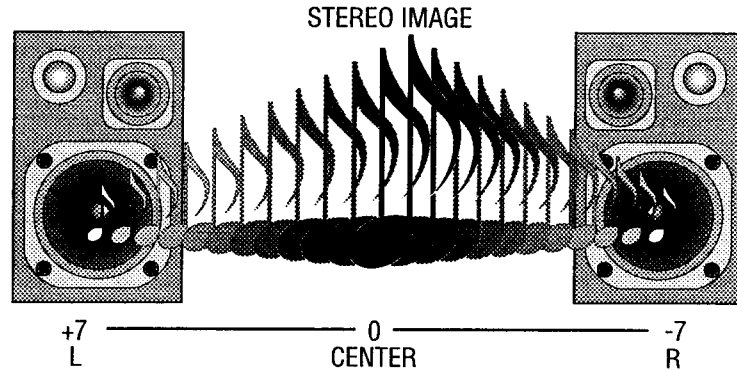

(OUTPUT)

```
EFFECT PACH  H
PAN          = +7
```

<Procedure>

- (1) Press the **EFFECT** several times to display the PAN Setting screen (K4 only – use the **OUTPUT** on the K4r).
- (2) Make the setting with the VALUE Slider or the **+YES** and **-NO**.

● EFFECT SEND 1 and 2 (K4 only)

(Value: 0 to 100)

Set the level of the Effect.

Effect modes 1 through 9 are Single type Effects (only one type of Effect is applied).

(OUTPUT)

```
EFFECT PACH  H
SEND 1      =100
```

<Procedure>

- (1) Press the **EFFECT** several times to display the SEND Setting screen (K4 only – use the **OUTPUT** on the K4r).
- (2) Make the Setting with the VALUE Slider or the **+YES** and **-NO**.
- (3) Set SEND 2 with EFFECT Type 10 through 16.

4. Explanation of Effect Types

● REVERB

Reverb can simulate sound in a room, whether a bathroom, garage, concert hall, or the Taj Mahal. There are several parameters that affect reverb.

Reverb Time is how long the reverb will sound. This approximates the size and "liveness" of the room.

Predelay is the time before any reverb effect starts. In an actual room this is related to the distance between the source and the nearest wall surface, which provides the *first reflection* of the sound and starts the sound reverberating throughout the room. Naturally in a large room the Predelay would be longer; in a small room, shorter.

Tone relates to the construction of the room, whether tile (bright) or carpet (dull).

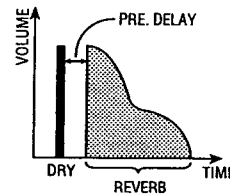

● GATE REVERB

Gated reverb is reverb processed through a gate. The gate cuts off the reverberation before it decays naturally, a popular effect in recording studios. Good for drums.

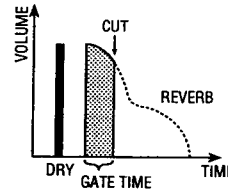

● REVERSE GATE

In this type, the original sound plays normally, but the reverb is sampled and then played in reverse. Great for drums especially snare.

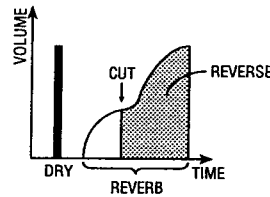

● NORMAL DELAY

This effect produces a repeating delay, that decays gradually to zero. Delay Time adjusts the time between repeats, Feedback adjusts the relative level between each successive repeat, tone adjusts the timbre of the delay. This is useful for many situations, for example bass guitar using a short delay time and a small amount of feedback, or a synth solo with long decay and no feedback.

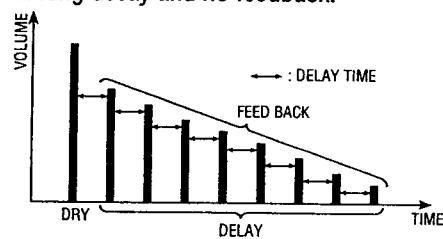

● STEREO PAN DELAY

This is the same as the normal delay except the repeats alternate from left and right outputs. Width controls the panning between center and extreme Left/Right.

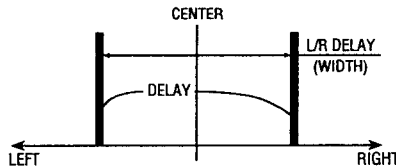

● CHORUS

Chorus creates slight variations in pitch and time, like a rotating organ speaker, resulting in enhanced dimensionality of sound. Chorus is created by delaying a sound by a very small amount (1 to 2 milliseconds) and mixing the delayed sound with itself. The traditional 'sweeping chorus' sound is caused by modulating the delay time with an LFO. In the K4, the chorus has controls for the speed of modulation (rate) and the amount of modulation (width).

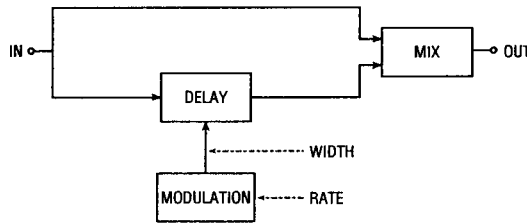

● FLANGER

Flanging is similar to chorusing, except a feedback control allows the delayed signal to be delayed again, similar to a repeating echo except the repeat times are so short that a deeper modulation effect is caused. Flanging is useful for guitar and other electric sounds.

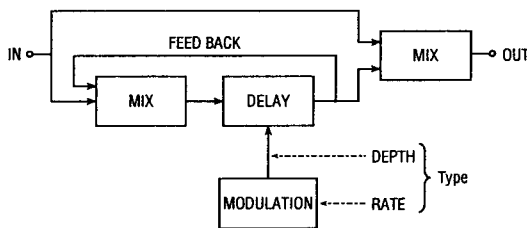

● OVER DRIVE

Overdrive adds a clipping distortion to the sound, milder than a fuzz tone but more useful. Drive controls the amount of clipping. Try it with guitar or organ.

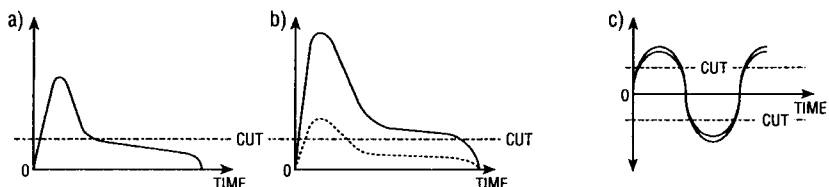

5. Writing EFFECT (K4) and OUTPUT (K4r) Settings

<Procedure>

Note: Make sure that the PROTECT is OFF, and perform the following procedure.

(OUTPUT)

```
EFFECT WRITE
TO           =I 1
```

(OUTPUT)

```
EFFECT WRITE
EXEC?=Y/N
```

```
EFFECT WRITE
SURE?=Y/N
```

+ YES

```
COMPLETED!
```

- NO

```
CANCELED!
```

- (1) Press the to display the following screen.
- (2) Select INT (internal) or EXT (card) with the VALUE Slider or and , and then press the .
- (3) Select the number of the EFFECT to be written with the VALUE Slider or the and , and then press the .
- (4) The message "EXEC?" will then appear. Press to execute writing or to cancel.
- (5) If you pressed in step (4), the message "SURE?" will appear to ask you for confirmation. Press to execute writing or to cancel.

Notes: If necessary, set the PROTECT to OFF.
A new card must be formatted before it can be written to. (See P. 26)

2-9. SYSTEM Programming

This sets the values that affect the entire K4/K4r unit. These values can be divided broadly into the following three groups.

- SYS (SYSTEM)
- TRS (MIDI Transmit)
- RCV (MIDI Receive)

■ SYS (SYSTEM) Group

- TUNE
- TRANSPOSE
- LOCAL CONTROL
- VELOCITY SWITCH POINT

● TUNE

(Value: -50 to 0 to +50)
See P. 14.

● TRANSPOSE

(Value: -12 to 0 to +12)
See P. 14.

● LOCAL CONTROL (K4 only)

(Value: ON or OFF)

LOCAL CONTROL is a function for disconnecting the K4 keyboard from the internal tone generator. (For details, see "The Fundamentals of MIDI" on P. 18.)

ON: The keyboard is connected to the tone generator.

OFF: The keyboard is separated from the tone generator.

Note: This is handy when using the K4 as a MULTI tone generator for a MIDI sequencer or computer. If you don't hear any sound on the K4 when playing the keyboard, make sure local control is on.

● VELOCITY SWITCH POINT (VEL SW POINT)

(Value: 1 to 128)

The Velocity Switch Point at which switching between SOFT and LOUD takes place is set using the MULTI PLAY and Velocity Switches. (See P. 63, 87)

```
SYSTEM
LOCAL          =ON
```

```
SYSTEM
VELSW POINT=64
```

■ TRS (TRANSMIT) Group

These are the settings for MIDI Transmission.

- TRANSMIT CHANNEL
- PROGRAM CHANGE
- PRESSURE
- BENDER
- MODULATION
- HOLD
- VELOCITY

```
MIDI
TRS CH      = 1
```

● TRANSMIT CHANNEL (TRS CH)

(Value: 1 to 16)

Sets the channel for MIDI Transmission.

```
MIDI
TRS PGM     =ON
```

● PROGRAM CHANGE (TRS PGM)

(Value: ON or OFF)

Selects whether a Program Change is to be transmitted.

```
MIDI
TRS PRS     = ON
```

● PRESSURE (TRS PRS) (K4 only)

(Value: ON or OFF)

Selects whether Pressure data is to be transmitted.

```
MIDI
TRS BND     =ON
```

● BENDER (TRS BND) (K4 only)

(Value: ON or OFF)

Selects whether Bender data is to be transmitted.

```
MIDI
TRS MOD     =ON
```

● MODULATION (TRS MOD) (K4 only)

(Value: ON or OFF)

Selects whether Modulation data is to be transmitted.

```
MIDI
TRS HOLD    =ON
```

● HOLD (TRS HOLD) (K4 only)

(Value: ON or OFF)

Selects whether Hold pedal data is to be transmitted.

```
MIDI
TRS VEL     =ON
```

● VELOCITY (TRS VEL) (K4 only)

(Value: ON or OFF)

Selects whether Velocity data is to be transmitted.

■ RCV (RECEIVE) Group

These are the settings for MIDI Reception.

- RECEIVE CHANNEL
- OMNI ON/OFF
- PROGRAM CHANGE
- PRESSURE
- BENDER
- MODULATION
- VOLUME
- HOLD
- VELOCITY
- EXCLUSIVE

<Procedure>

- (1) Press the **SYSTEM** to display the SYSTEM COMMAND Select screen.
- (2) Select "RCV" with the **+ YES** and **- NO**.

```
MIDI
RCV CH      = 1
```

● RECEIVE CHANNEL (RCV CH)

(Value: 1 to 16)

Sets the channel for MIDI Reception.

```
MIDI
OMNI       =ON
```

● OMNI

(Value: ON or OFF)

Selects OMNI ON or OFF. If OMNI is On, data on any channel will be received and played when in SINGLE mode.

```
MIDI
RCV PGM    =NORM
```

● PROGRAM CHANGE (RCV PGM) (See P. 88)

(Value: OFF, NORM, SECT or LINK)

Selects whether a Program Change is to be recognized.

OFF: All data will be ignored.

NORM: Switches between SINGLE Patches (0 to 63) and MULTI Patches (64 to 127).

SECT: Switches between SINGLE Patches in the eight MULTI Patch Sections which have matching MIDI channels.

LINK: Switches the K4/K4r to the next patch in the LINK series.

SINGLE	1	2	3	4	5	6	7	8	9	10	11	12	13	14	15	16
A	0	1	2	3	4	5	6	7	8	9	10	11	12	13	14	15
B	16	17	18	19	20	21	22	23	24	25	26	27	28	29	30	31
C	32	33	34	35	36	37	38	39	40	41	42	43	44	45	46	47
D	48	49	50	51	52	53	54	55	56	57	58	59	60	61	62	63
MULTI	1	2	3	4	5	6	7	8	9	10	11	12	13	14	15	16
A	64	65	66	67	68	69	70	71	72	73	74	75	76	77	78	79
B	80	81	82	83	84	85	86	87	88	89	90	91	92	93	94	95
C	96	97	98	99	100	101	102	103	104	105	106	107	108	109	110	111
D	112	113	114	115	116	117	118	119	120	121	122	123	124	125	126	127

Notes: These program change numbers are used for both internal and external memory.
 If you want to change from internal to external patch banks (or vice versa), you should send an EXCLUSIVE Message for K4/K4r before sending program change number. The data format of MIDI EXCLUSIVE Message is as See P. 88
 This SYSTEM EXCLUSIVE Message is also transmitted when the "SINGLE: INT/EXT" or "MULTI: INT/EXIT" switches.

```
MIDI
RCV PRS      =ON
```

● **PRESSURE (RCV PRS)**
 (Value: ON or OFF)
 Selects whether Aftertouch data is to be recognized.

```
MIDI
RCV BND      =ON
```

● **BENDER (RCV BND)**
 (Value: ON or OFF)
 Selects whether Bender data is to be recognized.

```
MIDI
RCV MOD      =ON
```

● **MODULATION (RCV MOD)**
 (Value: ON or OFF)
 Selects whether Modulation data is to be recognized.

```
MIDI
RCV VOL      =SECT
```

● **VOLUME (RCV VOL)**
 (Value: OFF, NORM, SECT)
 Selects whether Volume data is to be recognized.

```
MIDI
RCV HOLD     =ON
```

● **HOLD (RCV MOD)**
 (Value: ON or OFF)
 Selects whether Hold data is to be recognized.

```
MIDI
RCV VEL      =ON
```

● **VELOCITY (RCV VEL)**
 (Value: ON or OFF)
 Selects whether Velocity data is to be recognized.

```
MIDI
RCV EXCL     =ON
```

● **EXCLUSIVE (RCV EXCL)**
 (Value: ON or OFF)
 Selects whether SYSTEM EXCLUSIVE data is to be recognized.

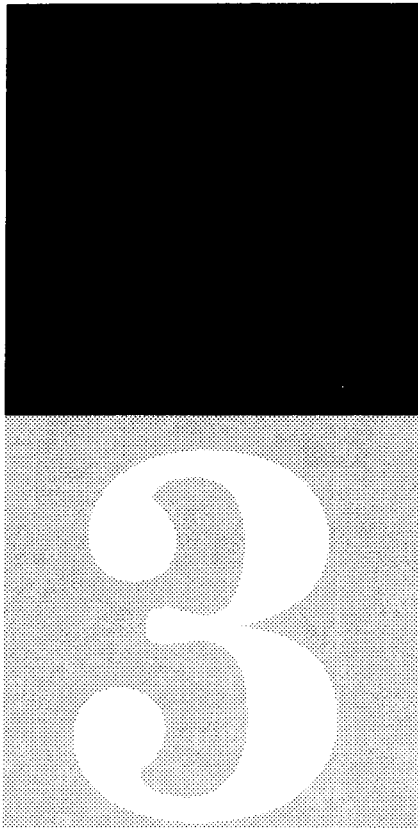

Chapter 3. Advanced Applications

This chapter explains advanced techniques and information for the player and composer when using the K4/K4r and MIDI.

3-1. MIDI DATA DUMP

3-2. Play Using a Sequencer or Computer

3-3. MULTI Real Time Play

3-4. MIDI for the Advanced User

3-1. MIDI DATA DUMP

The K4/K4r can execute MIDI Data Dumps of individual patches, blocks of patches, or the entire patch memory.

Data control is easy when a sequencer with a MIDI Data Dump function such as the Q-80 is used. With the Q-80, data equivalent to about 40 times the storage capacity of the K4/K4r can be saved on a 2DD disk.

Parameter	TONE	*SGL	*MLT	EFCT	*EFF	DRUM	ALL
Dump Data				(OUT)	(*OUT)	(*OUT)	
SINGLE	1Patch	64Patch					ALL
MULTI	1 Patch		64Patch				
DRUM						1KIT	
EFFECT				1Patch	32Patch		
Comment	*1	*2	*2	*1	*2	*2	*2

*1 Selected Patch

*2 INT (Internal) or EXT (Card)

Before performing the MIDI Data Dump, select the patches set for the EFFECT (OUTPUT) Settings or Patches and Blocks which you wish to transmit.

Example: Transmit EFFECT setting #17

<Procedure>

```
MIA-1 NYLBI DICE
EFFECT PACH= 1
```

```
MIDI
DUMP SELECT=EFCT
```

```
DATA DUMP
EXEC?=Y/N
```

- Choose SINGLE or MULTI PLAY, press , and select the following screen.
- Select "17" with the VALUE Slider or and .
- Press several times to display the MIDI Data Dump Select screen. Select "EFFC" with the VALUE Slider or and .
- Press once to display the MIDI Data Dump Select screen.

Note: If necessary, ready the connected instrument for receiving the MIDI Data Dump.

```
DATA DUMP
SURE?=Y/N
```

```
COMPLETED!
```

```
CANCELED!
```

- After you press , you will be asked if you are sure – press again to confirm. The message "COMPLETED!" will be displayed when the dump has finished.

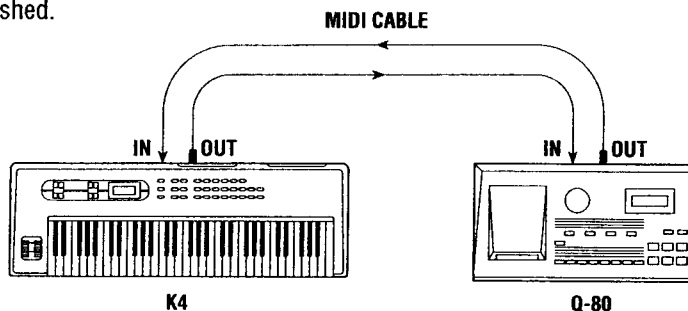

Refer to the "DATA DUMP" command for the Q-80 Owner's Manual for the Q-80.

3-2. Play Using a Sequencer or Computer

With the MULTI mode, the K4/K4r can function as a synthesizer and drum sound source with up to eight parts. This means that an extremely simple setup such as the K4 (or K4r) and a Q-80 or other MIDI sequencer (or computer) can produce an extensive range of sounds.

Let's use the procedure shown below to actually connect a MIDI sequencer for performance.

● MIDI Sequencer Connection

In this example, a Kawai Q-80 is used as the sequencer. Connect it to the K4/K4r as shown in the illustration.

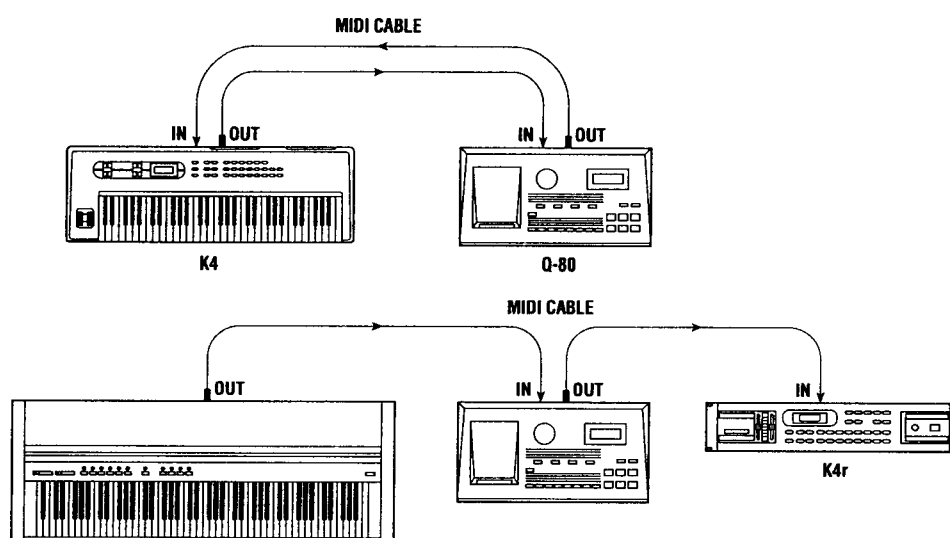

● Setting the SYSTEM LOCAL ON/OFF

Since the K4 itself can be used as a control keyboard or sound source, selecting a LOCAL ON/OFF Setting is necessary. The LOCAL Setting should be set to OFF (no sound output from the keyboard) when MULTI Performances on a sequencer or computer are being played with the K4. (Does not affect K4r.)

<Procedure>

```
SYSTEM
LOCAL      =OFF
```

Press **SYSTEM** several times until "SYSTEM LOCAL" is displayed. Turn off LOCAL using **+YES** and **-NO**. (See P. 77)

* This separates the keyboard and sound generator of the K4 so that no sound will be output unless the MIDI Transmit and Receive Channels are matched (except when set at OMNI ON). (See P. 79)

If you are using the Q-80 sequencer, set ECHO to THRU in order to output sound from the K4/K4r (see the Q-80 Owner's Manual). On other sequencers, this function has various names such as "Patch thru", "loop", etc.

● MULTI Settings

Decide what Sections will be played, and what tones and MIDI Channels they will use. The settings for this are made in the same way as for MULTI real time play. Here we will use the MULTI ID-13 which is preset. The following table shows you what settings to make for this MULTI.

Section number	Timbre	Receive MIDI channel
1	IB-6 Big Brass	1
2	IA-10 ChoperBass	2
3	IA-2 Bright EP	3
DRUM		10

Let's use this MULTI to play a demo song on the sequencer.

● Demo Song Input

Input the following demo song score into the sequencer. (Refer to the sequencer's manual for an explanation on how to input music.)

Brass

E. Piano

Bass

Drums

$\text{♩} = 98$

$\text{♩} = \text{♩}$

$C\#M7^{\flat 9}$

$A^{\flat}M7/B^{\flat}$ $D^{\flat}7^{\flat 9}.13$ $C\#M7^{\flat 9}$ $B^{\flat}\#7^{\flat 9}$ $E^{\flat}7^{\flat 9}.13$ $A^{\flat}M7^{\flat 9}$ $D^{\flat}M7^{\flat 9}$ $C\#M7^{\flat 9}$

Listen to the song after you have input it. The song is only four bars long, so it might be best to repeat it.

What did you think? As you can see, quite a large range of performances can be obtained simply by connecting the K4/K4r to a sequencer or computer. Also, while the demo song used only four sections, the K4/K4r allows you to play using up nine different sections, including the DRUM Section. When doing this, you should be sure not to play more than 16 voices simultaneously including the DRUM Section.

3-3. MULTI Real Time Play

MULTI allows you to create a variety of features using SINGLE Patch Settings. A number of examples of these settings are shown below – experiment with them to make yourself familiar with how they work.

● LAYER (UNISON)

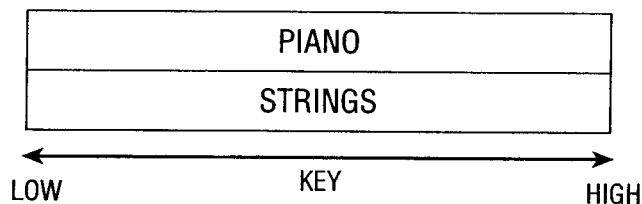

For ID-1, as you can see in the illustration above, a PIANO Sound is layered over a STRINGS Sound when a single key is pressed.

UNISON Settings can be made using data like that shown below.

MULTI NO.: ID-1	VOL: 86	EFFECT: Chorus (K4 only)				NAME: LAYER 1			
SW	PARAMETER	SEC1	SEC2	SEC3	SEC4	SEC5	SEC6	SEC7	SEC8
A	SINGLE	ID-2	IA-3	MUTE	MUTE	MUTE	MUTE	MUTE	MUTE
	INST ASSIGN	C Grand	Strings						
B	ZONE LO	C-4	C-4						
	ZONE HI	G6	G6						
	VEL SW	ALL	ALL						
C	RCV CH	1	1						
	SEC ch (MODE)	KYBD	KYBD						
D	LEVEL	85	50						
	LEVEL TRANS	0	0						
	TUNE	0	0						
	SUBMIX CH	A	A						

* When playing a number of LAYER (UNISON) tones, set MODE for the K4 to KYBD, and RCV CH for the K4r to the same one.

3-4. MIDI for the Advanced User

● Control Change Messages

Control Change Number	Transmit	Receive	Remarks
1 Modulation	○ (K4r X)	○	0 ~ 127
6 Value Slider	○	○	0 ~ 127
7 Volume	X	○	0 ~ 127
64 Hold	○ (K4r X)	○	0, 127
100, 101 RPC	○ (0,1)	○ (0,1)	

● Program Change Messages

SINGLE	1	2	3	4	5	6	7	8	9	10	11	12	13	14	15	16
A	0	1	2	3	4	5	6	7	8	9	10	11	12	13	14	15
B	16	17	18	19	20	21	22	23	24	25	26	27	28	29	30	31
C	32	33	34	35	36	37	38	39	40	41	42	43	44	45	46	47
D	48	49	50	51	52	53	54	55	56	57	58	59	60	61	62	63

MULTI	1	2	3	4	5	6	7	8	9	10	11	12	13	14	15	16
A	64	65	66	67	68	69	70	71	72	73	74	75	76	77	78	79
B	80	81	82	83	84	85	86	87	88	89	90	91	92	93	94	95
C	96	97	98	99	100	101	102	103	104	105	106	107	108	109	110	111
D	112	113	114	115	116	117	118	119	120	121	122	123	124	125	126	127

Notes: These program change numbers are used for both internal and external memory.

If you want to change from internal to external patch banks (or vice versa), you should send an EXCLUSIVE Message for K4/K4r before sending program change number.

The data format of MIDI EXCLUSIVE Message is as below:

```

FO 40 00 30 04 00(INT) or 02(EXT) 00 F7
    
```

This SYSTEM EXCLUSIVE is also transmitted when the SINGLE or MULTI INT/EXT.

● System Exclusive Messages

(1). EXCLUSIVE Data Format

Status	F0H	SYSTEM EXCLUSIVE Message
Kawai ID number	40H	
Channel number	0nH	
Function number		
Group number	00H	
Model ID number	04H	
Subcommand 1		
Subcommand 2		
Data		
Data		
EOX		EXCLUSIVE Data END

(2) Dump Request

Depending on the type of Dump Request, the values in the following table are substituted for function number, subcommand 1, and subcommand 2 in the EXCLUSIVE Data Format shown in item 1) above.

Dump request type			Function number	Subcommand 1	Subcommand 2
ONE DUMP	SINGLE	INT	00H	00H	00H-3FH
		MULTI			40H-7FH
				EFFECT	01H
		DRUM			
	SINGLE			EXT	02H
		40H-7FH			
		MULTI		03H	00H-1FH
ALL DUMP	INT	02H	00H	00H	
	EXT		02H	00H	
ALL SINGLE	INT	01H	00H	00H	
	EXT		02H		
ALL MULTI	INT		00H	40H	
	EXT		02H		
ALL EFFECT	INT	01H	01H	00H	
	EXT		03H		
ALL DRUM	INT	00H	01H	20H	
	EXT		03H		

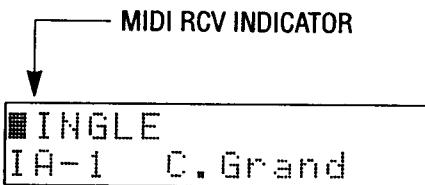

Notes: MIDI RCV INDICATOR
 Every time the K4/K4r receives MIDI data, the sign appears at the upper left corner.

ADVANCED USER

APPENDICES

A-1. Error Messages

An error message will be displayed if an operation is incorrect or contains some error. If an error message appears, check this section and take action as explained to correct the problem.

Messages Appearing During WRITE or SAVE/LOAD Operations

Message	Cause	Response
PROTECTED!	The WRITE PROTECT parameter for the destination (internal memory or card) is ON.	Turn off WRITE PROTECT for the internal memory or card. (See P. 27)
NO CARD!	A LINK, WRITE, SAVE, or LOAD operation was attempted with the card not inserted.	Insert the card correctly.
ID ERROR!	An attempt was made to select a Patch using a card not formatted for the K4/K4r.	Use a correct card, or reformat it. (See P. 26)
CAN'T WRITE!	An attempt was made to SAVE data to a ROM card.	Use a RAM card.

Messages Appearing When the Batteries Need Replacing

Message	Cause	Response
CHECK! INTERNAL BATTERY	The backup battery for the K4/K4r is almost dead.	Contact your Kawai Service Center.

A-2. Troubleshooting

Since the K4/K4r is equipped with a wide variety of functions, depending on the settings, it may not operate as expected. Also, sound may not be output due to connected amplifiers or other equipment. This chart explains troubleshooting for these types of problems.

Problem	Possible cause	Page to see
No sound	Is the VOLUME too low? Adjust the VOLUME on the K4/K4r or any connected amplifiers or other equipment.	P. 5
	Can sound be heard through headphones when connected? If sound is heard, the problem cause may be with connected equipment or cords. Check connections	P. 5, 10
	(When in the SINGLE or MULTI PLAY mode) Is the Section volume or VOLUME level too low?	P. 33, 61, 64
	(When in the MULTI PLAY mode) Is the Section PLAY mode set for MIDI?	P. 67, 63, 79
	Is the MIDI function LOCAL CONTROL turned off?	P. 77
	Is the volume level for the K4/K4r too low because of MIDI volume data from external MIDI equipment? Turn the power off, and then on again.	P. 80
	After lowering the volume on the amplifier or other connected equipment, turn the power off and then on again.	P. 10
Sound is distorted	Is the connection to the amplifier's IN jack secure?	P. 10
DRUM Section does not play	Is the volume level for the DRUM Section too low?	P. 67
	Is the MIDI channel for the DRUM Section set correctly?	P. 67
Pitch is out of tune	Are TRANSPOSE and TUNE set correctly?	P. 14, 64
	Is the master tuning setting incorrect? If the pitch of a particular patch is out of tune, check the parameter setting for that patch.	P. 46, 68
The pitch of a pressed key is not played	Are the COARSE and FINE Settings for the Sources correct?	P. 46
No chord produced	Is the SOLO mode set?	P. 35
MIDI data cannot be transmitted or received correctly.	Are the MIDI functions for the transmitting and receiving equipment set correctly?	P. 63, 67, 79

A-3. Parameter Reference Chart

The technical parameters for a SINGLE Patch are shown below.

SINGLE EDIT

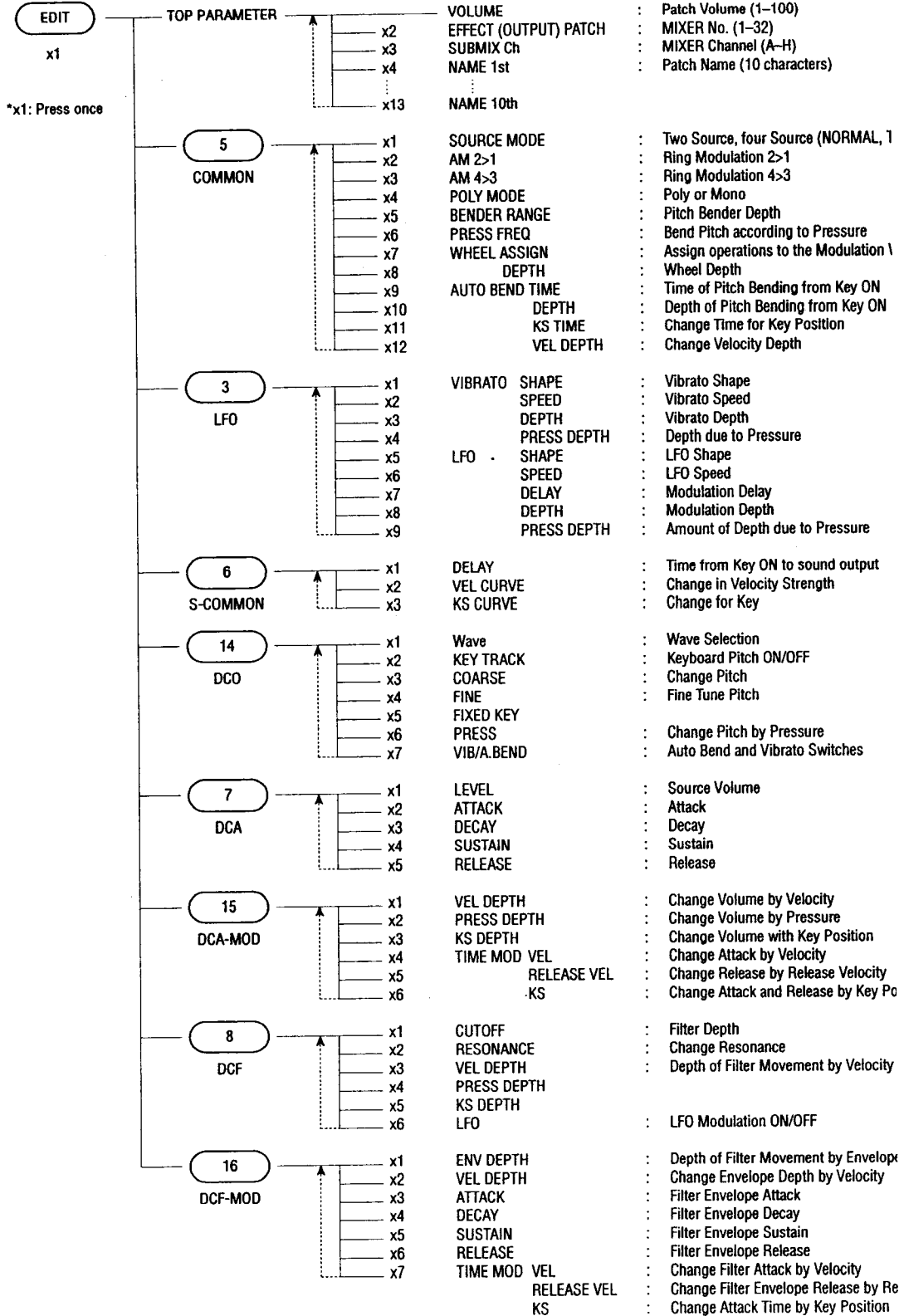

A-5. Blank Chart

K4 PARAMETER LIST

PATCH

SINGLE EDIT	VOLUME						
	EFFECT PATCH (OUTPUT PATCH)						
	SUBMIX CH						
	NAME						
	COMMON	SOURCE MODE					
		AM					
		POLY MODE					
		BENDER RANGE					
		PRESS FREQ					
		WHEEL ASSIGN					
		DEPTH					
		AUTO BEND TIME					
		DEPTH					
		KS TIME					
	VEL DEPTH						
	LFO	VIBRATO SHAPE					
		SPEED					
		DEPTH					
		PRESS DEPTH					
		DCF-LFO SHAPE					
		SPEED					
		DELAY					
		DEPTH					
		PRESS DEPTH					
				S1	S2	S3	
	S-COMMON	DELAY					
		VEL CURVE					
		KS CURVE					
	DCO	WAVE					
		KEY TRACK					
		COARSE					
		FINE (FIXED KEY)					
		PRESS FREQ					
		VIB/A.BEND					
	DCA	LEVEL					
		ATTACK					
		DECAY					
		SUSTAIN					
	DCA MOD	RELEASE					
		VEL DEPTH					
		PRESS DEPTH					
		KS DEPTH					
		TIME MOD ATTACK					
		RELEASE					
	DCF	KS					
		CUT OFF					
		RESONANCE					
		VEL DEPTH					
		KS DEPTH					
	DCF MOD	LFO					
		ENV DEPTH					
		VEL DEPTH					
		ATTACK					
		DECAY					
		SUSTAIN					
		RELEASE					
		TIME MOD ATTACK					
		RELEASE					
		KS					

PATCH

MULTI EDIT	VOLUME								
	EFFECT PATCH (OUTPUT PATCH)								
	NAME								
	SECTION		1	2	3	4	5	6	7
	INST	SINGLE							
		NO. NAME							
	ZONE	ZONE LO							
		HI							
		VEL SW							
	SEC CH	RCV CH							
		MODE							
	OUTPUT	LEVEL							
		TRANS							
		TUNE							
		SUBMIX CH							

A-4. DRUM SECTION and EFFECT Factory Settings

CARD NAME	KEY NAME	NOTE NO	WAVE S1 S2	DECAY S1 S2	TUNE S1 S2	LEVEL S1 S2	SUBMIX CH			
BD 1	C1	96	97	97	31	31	-3	95	96	H
RIMSHOT 1	CR1	97	103	103	45	46	+1	96	98	B
SD 1	D1	98	101	101	39	37	+3	93	98	B
Claps 1	DR1	99	118	118	27	23	+6	+5	90	A
SD 2	E1	100	102	101	45	41	-9	+5	95	B
LO E TOM	F1	101	106	106	50	38	-49	-21	94	F
WHCL 1	FR1	102	107	107	57	57	+12	+12	95	E
LO TOM 1	G1	103	104	100	93	41	-23	-17	90	F
WHCL 2	GR1	104	108	108	35	48	+4	+4	95	E
MID E TOM	A1	105	106	106	50	38	-18	+20	94	B
WHCL 3	HR1	106	108	108	50	48	0	0	78	E
MID TOM 1	B1	107	104	106	83	41	-6	-11	97	B
HI E TOM	C2	108	106	106	50	35	-5	+20	95	E
GLASH	CR2	109	112	112	65	65	-2	-2	92	E
HI TOM 1	D2	110	105	104	43	43	+8	+4	95	E
RIDE EDGE	DR2	111	115	115	55	55	0	0	85	F
CLASH 2	E2	112	112	112	57	48	-13	-13	90	G
RIDE CUP	F2	113	117	117	59	48	0	0	92	F
Tamb.	FR2	114	123	123	35	43	0	0	85	A
Splash	G2	115	112	112	55	43	+18	+18	83	B
Cowbell	GR2	116	119	119	35	35	-2	-2	92	B
MUTE CRASH	A2	117	112	112	47	41	-2	-2	92	E
SD 3	AR2	118	99	99	28	25	0	0	90	B
MUTE RIDE	B2	119	116	116	45	46	-1	-1	92	F
Hi Bongo	C3	120	120	120	29	28	+50	+50	95	E
Lo Bongo	CR3	121	120	120	29	29	+31	+31	96	F
Hi Mute Conga	D3	122	121	121	29	25	+12	+12	80	E
Hi Conga	DR3	123	120	120	41	35	-4	-4	87	E
Lo Conga	E3	124	120	120	41	16	-18	-18	91	F
Hi Timbale	F3	125	125	125	42	38	+2	+2	80	E
Lo Timbale	FR3	126	125	125	42	38	-16	-16	85	F
Hi Agogo	G3	127	119	119	30	30	+50	+50	88	E
Lo Agogo	GR3	128	119	119	30	30	+29	+29	88	E
Shaker	A3	129	126	127	32	34	0	0	84	B
Miracas	AR3	130	127	127	32	34	+5	+5	86	A
Cha 1	B3	131	139	138	38	38	-13	-13	68	B
Cha 2	C4	132	139	139	38	38	-13	-13	68	B
Shi-tai	CR4	133	130	130	43	41	+2	+2	81	A
Click	D4	134	133	133	33	30	-3	-3	92	A
Chaver	DR4	135	124	124	33	33	0	0	95	A
BRUSH 1	E4	136	237	193	43	46	+6	+11	57	B
BRUSH 2	F4	137	192	192	51	49	-18	-18	43	B
Pole	FR4	138	134	134	44	41	-3	-3	95	A
Timpany	G4	139	129	129	51	51	-23	-23	95	F
Timpany	GR4	140	129	129	49	46	+0	+0	85	E
Timpany	AR4	141	129	129	47	47	+12	+12	95	E
BD 2	B4	142	99	127	47	37	-4	-50	95	H
BD 3	C5	143	125	98	22	45	-28	-13	82	H
BD 4	CR5	144	1	1	38	0	30	+3	95	H
SD 4	D5	145	106	192	1	40	26	+28	61	B
SD 5	DR5	146	103	103	32	37	0	0	108	B
SD 6	E5	147	101	101	50	52	-25	-3	91	B
BD 5	F5	148	97	104	33	42	+8	+50	92	H
WHCL 3	FR5	149	107	102	14	29	-1	+50	85	E
Claps 2	G5	150	118	116	33	47	+5	-50	94	B
HH FOOT	GR5	151	110	110	54	49	+3	+3	43	A
SD 7	A5	152	102	102	37	37	+3	+3	95	B
HH Drop	AR5	153	138	138	45	45	-42	-42	84	A
Door Knock	B5	154	137	137	34	35	-1	-1	94	B
Metal Hit	C6	155	132	132	44	27	-7	-7	94	A

TYPE	REVERB	SUBMIX	A	B	C	D	E	F	G	H	
1	P 1	REVERB 1	PAN	0	0	+7	+4	-4	-7	0	
A 2	2	SEND1	10	45	45	45	45	100	0	0	
M 3	31	SEND2	0	0	0	0	0	0	0	0	
2	P 1	REVERB 1	SUBMIX	A	B	C	D	E	F	G	H
A 2	5	PAN	0	0	+7	+7	+4	-4	-7	0	
M 3	3	SEND1	10	45	45	45	45	100	0	0	
3	P 1	REVERB 2	SUBMIX	A	B	C	D	E	F	G	H
A 2	6	PAN	0	0	+7	+7	+4	-4	-7	0	
M 3	10	SEND1	10	30	30	30	30	100	0	0	
4	P 1	REVERB 2	SUBMIX	A	B	C	D	E	F	G	H
A 2	6	PAN	0	0	+7	+7	+4	-4	-7	0	
M 3	3	SEND1	24	45	45	45	45	100	0	0	
5	P 1	REVERB 3	SUBMIX	A	B	C	D	E	F	G	H
A 2	3	PAN	0	0	+7	+7	+4	-4	-7	0	
M 3	15	SEND2	0	0	0	0	0	0	0	0	
6	P 1	REVERB 3	SUBMIX	A	B	C	D	E	F	G	H
A 2	0	PAN	0	0	+7	+7	+4	-4	-7	0	
M 3	2	SEND1	10	20	20	20	20	100	0	0	
7	P 1	REVERB 4	SUBMIX	A	B	C	D	E	F	G	H
A 2	2	PAN	0	0	+7	+7	+4	-4	-7	0	
M 3	4	SEND2	0	0	0	0	0	0	0	0	
8	P 1	REVERB 4	SUBMIX	A	B	C	D	E	F	G	H
A 2	6	PAN	0	0	+7	+7	+4	-4	-7	0	
M 3	24	SEND2	0	0	0	0	0	0	0	0	
9	P 1	REVERB 1	SUBMIX	A	B	C	D	E	F	G	H
A 2	0	PAN	+7	+5	+2	0	-2	-5	-7	0	
M 3	3	SEND1	30	30	30	30	30	30	0	0	
10	P 1	GATE REVERB	SUBMIX	A	B	C	D	E	F	G	H
A 2	1	PAN	0	0	+7	+7	+4	-4	-7	0	
M 3	24	SEND2	18	66	45	45	45	100	0	0	
11	P 1	REVERSE GATE	SUBMIX	A	B	C	D	E	F	G	H
A 2	2	PAN	0	0	+7	+7	+4	-4	-7	0	
M 3	5	SEND1	18	45	45	45	45	100	0	0	
12	P 1	OVER DRIVE + REV.	SUBMIX	A	B	C	D	E	F	G	H
A 2	7	PAN	0	0	0	0	0	0	0	0	
M 3	3	SEND1	12	48	97	12	48	97	97	0	
13	P 1	REVERB 1	SUBMIX	A	B	C	D	E	F	G	H
A 2	5	PAN	0	0	0	0	0	0	0	0	
M 3	6	SEND1	8	12	30	50	72	84	97	0	
14	P 1	REVERB 2	SUBMIX	A	B	C	D	E	F	G	H
A 2	6	PAN	0	0	0	0	0	0	0	0	
M 3	29	SEND2	60	60	60	60	60	60	60	0	
15	P 1	REVERB 3	SUBMIX	A	B	C	D	E	F	G	H
A 2	6	PAN	0	0	0	0	0	0	0	0	
M 3	5	SEND1	8	12	30	50	72	84	97	0	
16	P 1	REVERB 4	SUBMIX	A	B	C	D	E	F	G	H
A 2	6	PAN	0	0	0	0	0	0	0	0	
M 3	24	SEND2	60	60	60	60	60	60	60	0	

TYPE	Normal DELAY	SUBMIX	A	B	C	D	E	F	G	H	
17	P 1	Normal DELAY	PAN	0	0	0	0	0	0	0	
A 2	3	SEND1	12	30	48	64	72	84	97	0	
M 3	23	SEND2	60	60	60	60	60	60	60	0	
18	P 1	Normal DELAY	PAN	0	0	0	0	0	0	0	
A 2	0	PAN	0	0	0	0	0	0	0	0	
M 3	7	SEND1	12	30	48	64	72	84	97	0	
19	P 1	ST. PAN DELAY	SUBMIX	A	B	C	D	E	F	G	H
A 2	4	PAN	0	0	0	0	0	0	0	0	
M 3	5	SEND1	12	30	48	64	72	84	97	0	
20	P 1	ST. PAN DELAY	SUBMIX	A	B	C	D	E	F	G	H
A 2	3	PAN	0	0	0	0	0	0	0	0	
M 3	6	SEND1	12	30	48	64	72	84	97	0	
21	P 1	Normal DELAY X 2	SUBMIX	A	B	C	D	E	F	G	H
A 2	3	PAN	0	0	0	0	0	0	0	0	
M 3	0	SEND2	0	8	17	26	35	43	52	0	
22	P 1	CHORUS + PAN DLY	SUBMIX	A	B	C	D	E	F	G	H
A 2	4	PAN	0	0	0	0	0	0	0	0	
M 3	6	SEND1	97	97	97	40	40	40	97	0	
23	P 1	Normal & PAN DELAY	SUBMIX	A	B	C	D	E	F	G	H
A 2	3	PAN	0	0	0	0	0	0	0	0	
M 3	18	SEND2	60	60	60	60	60	60	60	0	
24	P 1	Normal & PAN DELAY	SUBMIX	A	B	C	D	E	F	G	H
A 2	7	PAN	0	0	0	0	0	0	0	0	
M 3	31	SEND2	60	60	60	60	60	60	60	0	
25	P 1	CHORUS	SUBMIX	A	B	C	D	E	F	G	H
A 2	7	PAN	0	0	0	0	0	0	0	0	
M 3	4	SEND1	12	30	48	64	72	84	97	0	
26	P 1	CHORUS	SUBMIX	A	B	C	D	E	F	G	H
A 2	5	PAN	0	0	0	0	0	0	0	0	
M 3	5	SEND1	12	30	48	64	72	84	97	0	
27	P 1	OV. DRIVE + FLANG.	SUBMIX	A	B	C	D	E	F	G	H
A 2	7	PAN	0	0	0	0	0	0	0	0	
M 3	24	SEND2	0	0	0	60	60	60	97	0	
28	P 1	CHORUS + N.DELAY	SUBMIX	A	B	C	D	E	F	G	H
A 2	7	PAN	0	0	0	0	0	0	0	0	
M 3	14	SEND2	28	28	28	28	28	28	28	0	
29	P 1	CHORUS + PAN DLY	SUBMIX	A	B	C	D	E	F	G	H
A 2	7	PAN	0	0	0	0	0	0	0	0	
M 3	3	SEND1	97	97	97	40	40	40	97	0	
30	P 1	OV. DRIVE + N.DELAY	SUBMIX	A	B	C	D	E	F	G	H
A 2	7	PAN	0	0	0	0	0	0	0	0	
M 3	12	SEND2	28	28	13	34	0	0	0	0	
31	P 1	CHORUS + PAN DLY	SUBMIX	A	B	C	D	E	F	G	H
A 2											

CARD NAME			VOLUME		RCV CH		VELO DEPTH				
INST	KEY NAME	NOTE NO.	WAVE S1	S2	DECAY S1	S2	TUNE S1	S2	LEVEL S1	S2	SUBMIX CH
	C 1	36									
	C#1	37									
	D 1	38									
	D#1	39									
	E 1	40									
	F 1	41									
	F#1	42									
	G 1	43									
	G#1	44									
	A 1	45									
	A#1	46									
	B 1	47									
	C 2	48									
	C#2	49									
	D 2	50									
	D#2	51									
	E 2	52									
	F 2	53									
	F#2	54									
	G 2	55									
	G#2	56									
	A 2	57									
	A#2	58									
	B 2	59									
	C 3	60									
	C#3	61									
	D 3	62									
	D#3	63									
	E 3	64									
	F 3	65									
	F#3	66									
	G 3	67									
	G#3	68									
	A 3	69									
	A#3	70									
	B 3	71									
	C 4	72									
	C#4	73									
	D 4	74									
	D#4	75									
	E 4	76									
	F 4	77									
	F#4	78									
	G 4	79									
	G#4	80									
	A 4	81									
	A#4	82									
	B 4	83									
	C 5	84									
	C#5	85									
	D 5	86									
	D#5	87									
	E 5	88									
	F 5	89									
	F#5	90									
	G 5	91									
	G#5	92									
	A 5	93									
	A#5	94									
	B 5	95									
	C 6	96									

OPTION DATA

1	TYPE		SUBMIX	A	B	C	D	E	F	G	H
	P 1		PAN								
	A 2		SEND1								
2	M 3		SEND2								
	TYPE		SUBMIX	A	B	C	D	E	F	G	H
	P 1		PAN								
3	A 2		SEND1								
	M 3		SEND2								
	TYPE		SUBMIX	A	B	C	D	E	F	G	H
4	P 1		PAN								
	A 2		SEND1								
	M 3		SEND2								
5	TYPE		SUBMIX	A	B	C	D	E	F	G	H
	P 1		PAN								
	A 2		SEND1								
6	M 3		SEND2								
	TYPE		SUBMIX	A	B	C	D	E	F	G	H
	P 1		PAN								
7	A 2		SEND1								
	M 3		SEND2								
	TYPE		SUBMIX	A	B	C	D	E	F	G	H
8	P 1		PAN								
	A 2		SEND1								
	M 3		SEND2								
9	TYPE		SUBMIX	A	B	C	D	E	F	G	H
	P 1		PAN								
	A 2		SEND1								
10	M 3		SEND2								
	TYPE		SUBMIX	A	B	C	D	E	F	G	H
	P 1		PAN								
11	A 2		SEND1								
	M 3		SEND2								
	TYPE		SUBMIX	A	B	C	D	E	F	G	H
12	P 1		PAN								
	A 2		SEND1								
	M 3		SEND2								
13	TYPE		SUBMIX	A	B	C	D	E	F	G	H
	P 1		PAN								
	A 2		SEND1								
14	M 3		SEND2								
	TYPE		SUBMIX	A	B	C	D	E	F	G	H
	P 1		PAN								
15	A 2		SEND1								
	M 3		SEND2								
	TYPE		SUBMIX	A	B	C	D	E	F	G	H
16	P 1		PAN								
	A 2		SEND1								
	M 3		SEND2								

17	TYPE		SUBMIX	A	B	C	D	E	F	G	H
	P 1		PAN								
	A 2		SEND1								
18	M 3		SEND2								
	TYPE		SUBMIX	A	B	C	D	E	F	G	H
	P 1		PAN								
19	A 2		SEND1								
	M 3		SEND2								
	TYPE		SUBMIX	A	B	C	D	E	F	G	H
20	P 1		PAN								
	A 2		SEND1								
	M 3		SEND2								
21	TYPE		SUBMIX	A	B	C	D	E	F	G	H
	P 1		PAN								
	A 2		SEND1								
22	M 3		SEND2								
	TYPE		SUBMIX	A	B	C	D	E	F	G	H
	P 1		PAN								
23	A 2		SEND1								
	M 3		SEND2								
	TYPE		SUBMIX	A	B	C	D	E	F	G	H
24	P 1		PAN								
	A 2		SEND1								
	M 3		SEND2								
25	TYPE		SUBMIX	A	B	C	D	E	F	G	H
	P 1		PAN								
	A 2		SEND1								
26	M 3		SEND2								
	TYPE		SUBMIX	A	B	C	D	E	F	G	H
	P 1		PAN								
27	A 2		SEND1								
	M 3		SEND2								
	TYPE		SUBMIX	A	B	C	D	E	F	G	H
28	P 1		PAN								
	A 2		SEND1								
	M 3		SEND2								
29	TYPE		SUBMIX	A	B	C	D	E	F	G	H
	P 1		PAN								
	A 2		SEND1								
30	M 3		SEND2								
	TYPE		SUBMIX	A	B	C	D	E	F	G	H
	P 1		PAN								
31	A 2		SEND1								
	M 3		SEND2								
	TYPE		SUBMIX	A	B	C	D	E	F	G	H
32	P 1		PAN								
	A 2		SEND1								
	M 3		SEND2								

Synthesizer
MODEL K4/K4r

MIDI Implementation Chart

Date: Aug. 1989
Version: 1.0

Function ...		Transmitted	Recognized	Remarks
Basic Channel	Default Changed	1—16 1—16	1—16 1—16	Memorized
Mode	Default Messages Altered	— X * * *	1, 3 OMNI ON/OFF	Memorized MONO ignored
Note Number	: True Voice	24—108 * * *	0—127 0—127	
Velocity	Note ON Note OFF	* *	* *	
After Touch	Key's Ch's	X *	X *	
Pitch Bender		*	*	
Control Change	1	*	*	Modulation
	7	X	*	Volume
	64	*	*	Hold 1
	101, 101 6	* (0, 1) *	* (0, 1) *	RPC Data entry
Prog Change	: True #	* ***	* 0—127	
System Exclusive		*	*	
System Common	: Song Pos : Song Sel : Tune	X X X	X X X	
System Real Time	: Clock : Commands	X X	X X	
Aux Messages	: Local ON/OFF : All Notes OFF : Active Sense : Reset	X ○ (123) ○ X	○ ○ (123~127) ○ X	
Notes	* Can be set to ○ or X Memorized even after turning off the power RPC #0=Pitch Bender sensitivity #1=Master fine tuning Values are given by Data entry			

Mode 1 : OMNI ON, POLY
Mode 3 : OMNI OFF, POLY

Mode 2 : OMNI ON, MONO
Mode 4 : OMNI OFF, MONO

○ : Y
X : N

OPTION DATA

INDEX

A		DECAY (DRUM)	68
AFTERTOUCHE (DCA)	49	DELAY (S-COMMON)	43
AFTERTOUCHE (DCF)	53	DRUM DECAY	68
AFTERTOUCHE (DCO)	36, 47	DRUM FACTORY SETTING	92'
AFTERTOUCHE (LFO)	41, 43, 47	DRUM INST COPY	69
AM	31, 35	DRUM KEY No.	68, 92
ATTACK (DCA)	48	DRUM MANUAL PLAY	16
ATTACK (DCF-MOD)	55	DRUM SUB MIX CH (EFFECT/OUTPUT)	68
AUTO BEND DEPTH	38	DRUM RCV CH	67
AUTO BEND KS TIME	38	DRUM TUNE	68
AUTO BEND TIME	37	DRUM VELO DEPTH	67
AUTO BEND VEL DEPTH	39	DRUM VOLUME	67, 68
B		DRUM WAVE	68
1→2 BAL	72	DUMP	82
BENDER RANGE	36	DUMP REQUEST	89
BLANK CHART	92	E	
C		EDIT DRUM	67
CARD	26	EDIT EFFECT (K4)	72
COARSE	46	EDIT MULTI	60
COMMON	34	EDIT OUTPUT (K4r)	72
COMPARE	28	EDIT SINGLE	32
COMPUTER USE	88	EFFECT	24, 71
CONFIGURATION OF DRUM	66	EFFECT FACTORY SETTING	92'
CONFIGURATION OF EFFECT	24, 71	EFFECT SUB MIX CH EDIT	73
CONFIGURATION OF K4	24	EFFECT TYPE (K4)	72, 74
CONFIGURATION OF MULTI	60	EFFECT PATCH (K4)	24, 33, 61, 71
CONFIGURATION OF OUTPUT	24, 71	EFFECT PARAMETER (K4)	72
CONFIGURATION OF SINGLE	29, 91'	EFFECT SEND (K4)	24, 71
COPY DRUM	69	EFFECT DEPTH (K4)	24, 71
COPY FILTER	57	ENV DEPTH (DCF-MOD)	54
COPY SOURCE	57	ERROR MESSAGES	90
CUTOFF	52	EXT	11, 12, 24
D		F	
DATA DUMP	82	FACTORY SETTING (DRUM)	92'
DC (DIGITAL CYCRIC)	31	FACTORY SETTING (EFFECT: K4/K4r)	92'
DCA	48	FILTER	52
DCA-MOD	49	FILTER COPY	57
DCF	52	FINE	46
DCF-MOD	54	FIXED KEY	47
DCO	46	FORMAT (CARD)	26
DECAY (DCA)	48		
DECAY (DCF-MOD)	55		

H		N	
HEADPHONES	5, 71	NAME (MULTI MODE)	61
HOLD (K4)	5	NAME (SINGLE)	33
I		O	
INDIVIDUAL OUT	71, 73	OFF VELOCITY (DCA)	51
INST OR SINGLE (MULTI MODE)	61	OFF VELOCITY (DCF)	56
INT	11, 12, 24	OMNI	79
K		OUTPUT SET	24, 33, 61, 71
KEY PRESSURE	AFTER TOUCH	P	
KEY TRACK	46	PAN (EFFECT)	24, 71
KEYBOARD SCALING	45	PAN (OUTPUT)	24, 71
KS CURVE	45	PARA OUT	24, 71
KS DEPTH (DCA-MOD)	50	PARAMETER REFERENCE CHART	91'
KS DEPTH (DCF)	53	PATCH SELECT	11, 12, 15
L		PITCH BEND	36
LAYER	13, 85	POLY MODE	35
LEVEL (DCA)	48	PRESS (FREQ)	36, 47
LEVEL (MULTI MODE)	64	PRESS DEPTH (DCA-MOD)	49
LFO (DCF)	42	PRESSURE	AFTER TOUCH
LFO (DCO)	VIBRATO	PREV (PREVIOUS)	28
LFO DELAY (DCF)	42	PROGRAM CHANGE	20, 78, 79, 88
LFO DEPTH (DCF)	42	PROTECT	27
LFO PERSS DEPTH (DCF)	43	R	
LFO SHAPE (DCF)	42	RCV CH (DRUM)	67
LFO SPEED (DCF)	42	RCV CH (MULTI MODE)	63
LINK PLAY	15	RCV CH (SYSTEM)	79
LINK SET	15	RECALL	28
LOAD FROM CARD	27	RELEASE (DCA)	49
LOCAL (SYSTEM)	77, 83	RELEASE (DCF-MOD)	55
M		RELEASE VELOCITY (DCA)	51
MIDI	18	RELEASE VELOCITY (DCF)	56
MIDI DATA DUMP	82	REL VEL	RELEASE VELOCITY
MIDI EXCLUSIVE ON/OFF	80	RESONANCE	53
MIDI IMPLEMENTATION CHART	95	S	
MIDI OMNI	79	S-COMMON	43
MIDI RCV	79	SAVE TO CARD	27
MIDI RCV CH (SYSTEM)	79	SECTION MUTE	60
MIDI TRS	78	SECTION SELECT	60
MIDI TRS CH	78	SEQUENCE PLAY	17, 83, 88
MODULATION WHEEL	5, 37	SINGLE (MULTI MODE)	61
MULTI PLAY	12, 83, 85	SINGLE PLAY	11

SOURCE COPY	57	VIBRATO DEPTH	41
SOURCE MODE	34	VIBRATO PRESS DEPTH	41
SOURCE MUTE	32	VIBRATO SHAPE	40
SOURCE SELECT	32	VIBRATO SPEED	40
SPLIT	13, 86	VOLUME (DRUM)	67
STRUCTURE	34	VOLUME (MULTI MODE)	61
SUB MIX CH	24, 33, 71	VOLUME (SINGLE MODE)	33
SUB MIX CH (DRUM)	68	VOLUME (UNIT)	5
SUB MIX CH (MULTI MODE)	64		
SUB MIX CH EDIT (EFFECT)	73	W	
SUSTAIN (DCA)	48	WAH WAH	LFO
SUSTAIN (DCF-MOD)	55	WAVE	31
SYSTEM LOCAL	77	WAVE (DRUM)	68
SYSTEM RCV	79	WHEEL ASSIGN	37
SYSTEM SYS	77	WRITE	below
SYSTEM TRANSPOSE	14	WRITE DRUM	70
SYSTEM TRS	78	WRITE EFFECT	76
SYSTEM TUNE	14	WRITE MULTI	65
SYSTEM VEL SW POINT	77	WRITE OUTPUT	76
		WRITE SINGLE	58
T			
TIME MOD VEL (ATTACK) (DCA-MOD)	50	Z	
TIME MOD VEL (ATTACK) (DCF-MOD)	56	ZONE (MULTI MODE)	62
TIME MOD KS (DCA-MOD)	51		
TIME MOD KS (DCF-MOD)	57		
TIME MOD REL VEL (DCA-MOD)	51		
TIME MOD REL VEL (DCF-MOD)	56		
TRANS (MULTI MODE)	64		
TRANSPOSE (SYSTEM)	14		
TROUBLE SHOOTING	91		
TUNE (DRUM)	68		
TUNE (MULTI MODE)	64		
TUNE (SYSTEM)	14		
V			
VALUE SET	28		
VARIABLE	60		
VEL CURVE	44		
VEL DEPTH (DCA-MOD)	49		
VEL DEPTH (DCF)	53		
VEL DEPTH (DCF-MOD)	55		
VEL SW (MULTI MODE)	63, 87		
VEL SW POINT (SYSTEM)	77		
VELOCITY	VEL		
VIB/A.BEND	47		

K4/K4r Specifications

KEYBOARD (K4)	61, WEIGHTED, w/Attack & Release Velocity and Aftertouch pressure
SOUND SYSTEM	(K4r: 2U rack-mounted digital synthesizer module)
MAX POLYPHONY	16 Bit PCM & DC WAVES (TOTAL 256 WAVES)
PROGRAM MEMORY	NORMAL:16, TWIN&DOUBLE:8 (32 SOURCES)
	INTERNAL: 128 (64 SINGLE/64 MULTI) + 61 DRUM
	DC-16 MEMORY CARD: 128 (64 SINGLE/64 MULTI) + 61 DRUM
SINGLE EDIT	<p>EDIT VOLUME, EFFECT PATCH (OUTPUT PATCH), SUBMIX CH, NAME</p> <p>5 SOURCE MODE, AM, POLY MODE, BENDER RANGE, PRESS > FREQ, COMMON WHEEL ASSIGN, DEPTH, AUTO BEND TIME, DEPTH, KS > TIME, VEL > DEPTH</p> <p>13 VIBRATO SHAPE, SPEED, DEPTH, PRESS DEPTH, DCF-LFO SHAPE, SPEED, LFO DELAY, DEPTH, PRESS DEPTH</p> <p>6 DELAY, VEL CURVE, KS CURVE, COPY S-COMMON</p> <p>14 WAVE, KEY TRACK, COARSE (FINE), FIXED KEY, PRESS on off, DCO VIB/A.BEND on off</p> <p>7 LEVEL, ATTACK, DECAY, SUSTAIN, RELEASE DCA</p> <p>15 VEL DEPTH, PRESS DEPTH, KS DEPTH, TIME MOD-VEL, RELEASE VEL, KS DCA MOD</p> <p>8 CUTOFF, RESONANCE, VEL DEPTH, PRESS DEPTH, KS DEPTH, LFO DCF</p> <p>16 ENV DEPTH, VEL DEPTH, ATTACK, DECAY, SUSTAIN, RELEASE, DCF MOD TIME MOD-VEL, RELEASE VEL, KS</p>
MULTI EDIT	<p>EDIT VOLUME, EFFECT PATCH (OUTPUT PATCH) NAME</p> <p>A SINGLE ASSIGN INST</p> <p>B ZONE LO, HI, VELOCITY SWITCH ZONE</p> <p>C RCV CH, (K4: MODE) SEC ch</p> <p>D LEVEL, TRANS, TUNE, SUBMIX CH LEVEL</p> <p>DRUM DRUM: (COMMON) VOLUME, RCV CH, VEL DEPTH</p>
DRUM EDIT	<p>(EACH KEY) KEY, WAVE S1, S2, DECAY S1, S2, TUNE S1, S2, LEVEL S1, S2, SUBMIX CH, COPY</p>
EFFECT EDIT	<p>EFFECT :K4 TYPE, PARAMETER 1, 2, 3, SUBMIX CH EDIT, PAN, SEND 1, 2</p>
SYSTEM	<p>OUTPUT :K4r SUBMIX CH EDIT, PAN/INDIV.</p> <p>SYSTEM SYS: TUNE, TRANSPOSE, LOCAL, VEL SW POINT, LINK 1-8 TRS: CHANNEL, PGM, (K4: PRS, BEND, MOD, HOLD, VEL) RCV: CHANNEL, OMNI, PGM, PRS, BEND, MOD, VOL, HOLD, VEL, EXCLUSIVE</p>
WRITE/DUMP	<p>WRITE WRITE, DATA DUMP, INT PROTECT, CARD PROTECT SAVE/LOAD, DUMP CARD FORMAT</p>
FRONT AND REAR	VOLUME, PATCH SELECT SW, DRUM SW, EFFECT SW (K4r: OUTPUT), (K4: WHEEL X 2)
PANEL CONTROLS & jacks	WRITE SW, POWER SW, DC IN, OUTPUT STEREO L/R (MONO) (K4r: +1-6), PHONE jack, CARD SLOT, MIDI IN/OUT/THRU
DISPLAY	16 x 2 LCD backlit
DIMENSIONS (mm)	K4: 1020 (W) x 310.8 (D) x 88.5 (H), K4r: 483 (W) x 218.5 (D) x 88 (H)
WEIGHT	K4: 7.3 kg, K4r: 2.8 kg
POWER CONSUMPTION	K4: 5.8 W, K4r: 6.8 W

CARD NAME			VOLUME		RCV CH		VELO DEPTH		SUBMIX CH	
INST	KEY NAME	NOTE NO.	WAVE S1	S2	DECAY S1	S2	TUNE S1	S2		LEVEL S1
	C 1	36								
	C#1	37								
	D 1	38								
	D#1	39								
	E 1	40								
	F 1	41								
	F#1	42								
	G 1	43								
	G#1	44								
	A 1	45								
	A#1	46								
	B 1	47								
	C 2	48								
	C#2	49								
	D 2	50								
	D#2	51								
	E 2	52								
	F 2	53								
	F#2	54								
	G 2	55								
	G#2	56								
	A 2	57								
	A#2	58								
	B 2	59								
	C 3	60								
	C#3	61								
	D 3	62								
	D#3	63								
	E 3	64								
	F 3	65								
	F#3	66								
	G 3	67								
	G#3	68								
	A 3	69								
	A#3	70								
	B 3	71								
	C 4	72								
	C#4	73								
	D 4	74								
	D#4	75								
	E 4	76								
	F 4	77								
	F#4	78								
	G 4	79								
	G#4	80								
	A 4	81								
	A#4	82								
	B 4	83								
	C 5	84								
	C#5	85								
	D 5	86								
	D#5	87								
	E 5	88								
	F 5	89								
	F#5	90								
	G 5	91								
	G#5	92								
	A 5	93								
	A#5	94								
	B 5	95								
	C 6	96								

OPTION DATA

1	TYPE			SUBMIX	A	B	C	D	E	F	G	H
	P	1		PAN								
	A	2		SEND1								
	R	3		SEND2								
2	TYPE			SUBMIX	A	B	C	D	E	F	G	H
	P	1		PAN								
	A	2		SEND1								
	R	3		SEND2								
3	TYPE			SUBMIX	A	B	C	D	E	F	G	H
	P	1		PAN								
	A	2		SEND1								
	R	3		SEND2								
4	TYPE			SUBMIX	A	B	C	D	E	F	G	H
	P	1		PAN								
	A	2		SEND1								
	R	3		SEND2								
5	TYPE			SUBMIX	A	B	C	D	E	F	G	H
	P	1		PAN								
	A	2		SEND1								
	R	3		SEND2								
6	TYPE			SUBMIX	A	B	C	D	E	F	G	H
	P	1		PAN								
	A	2		SEND1								
	R	3		SEND2								
7	TYPE			SUBMIX	A	B	C	D	E	F	G	H
	P	1		PAN								
	A	2		SEND1								
	R	3		SEND2								
8	TYPE			SUBMIX	A	B	C	D	E	F	G	H
	P	1		PAN								
	A	2		SEND1								
	R	3		SEND2								
9	TYPE			SUBMIX	A	B	C	D	E	F	G	H
	P	1		PAN								
	A	2		SEND1								
	R	3		SEND2								
10	TYPE			SUBMIX	A	B	C	D	E	F	G	H
	P	1		PAN								
	A	2		SEND1								
	R	3		SEND2								
11	TYPE			SUBMIX	A	B	C	D	E	F	G	H
	P	1		PAN								
	A	2		SEND1								
	R	3		SEND2								
12	TYPE			SUBMIX	A	B	C	D	E	F	G	H
	P	1		PAN								
	A	2		SEND1								
	R	3		SEND2								
13	TYPE			SUBMIX	A	B	C	D	E	F	G	H
	P	1		PAN								
	A	2		SEND1								
	R	3		SEND2								
14	TYPE			SUBMIX	A	B	C	D	E	F	G	H
	P	1		PAN								
	A	2		SEND1								
	R	3		SEND2								
15	TYPE			SUBMIX	A	B	C	D	E	F	G	H
	P	1		PAN								
	A	2		SEND1								
	R	3		SEND2								
16	TYPE			SUBMIX	A	B	C	D	E	F	G	H
	P	1		PAN								
	A	2		SEND1								
	R	3		SEND2								

17	TYPE			SUBMIX	A	B	C	D	E	F	G	H
	P	1		PAN								
	A	2		SEND1								
	R	3		SEND2								
18	TYPE			SUBMIX	A	B	C	D	E	F	G	H
	P	1		PAN								
	A	2		SEND1								
	R	3		SEND2								
19	TYPE			SUBMIX	A	B	C	D	E	F	G	H
	P	1		PAN								
	A	2		SEND1								
	R	3		SEND2								
20	TYPE			SUBMIX	A	B	C	D	E	F	G	H
	P	1		PAN								
	A	2		SEND1								
	R	3		SEND2								
21	TYPE			SUBMIX	A	B	C	D	E	F	G	H
	P	1		PAN								
	A	2		SEND1								
	R	3		SEND2								
22	TYPE			SUBMIX	A	B	C	D	E	F	G	H
	P	1		PAN								
	A	2		SEND1								
	R	3		SEND2								
23	TYPE			SUBMIX	A	B	C	D	E	F	G	H
	P	1		PAN								
	A	2		SEND1								
	R	3		SEND2								
24	TYPE			SUBMIX	A	B	C	D	E	F	G	H
	P	1		PAN								
	A	2		SEND1								
	R	3		SEND2								
25	TYPE			SUBMIX	A	B	C	D	E	F	G	H
	P	1		PAN								
	A	2		SEND1								
	R	3		SEND2								
26	TYPE			SUBMIX	A	B	C	D	E	F	G	H
	P	1		PAN								
	A	2		SEND1								
	R	3		SEND2								
27	TYPE			SUBMIX	A	B	C	D	E	F	G	H
	P	1		PAN								
	A	2		SEND1								
	R	3		SEND2								
28	TYPE			SUBMIX	A	B	C	D	E	F	G	H
	P	1		PAN								
	A	2		SEND1								
	R	3		SEND2								
29	TYPE			SUBMIX	A	B	C	D	E	F	G	H
	P	1		PAN								
	A	2		SEND1								
	R	3		SEND2								
30	TYPE			SUBMIX	A	B	C	D	E	F	G	H
	P	1		PAN								
	A	2		SEND1								
	R	3		SEND2								
31	TYPE			SUBMIX	A	B	C	D	E	F	G	H
	P	1		PAN								
	A	2		SEND1								
	R	3		SEND2								
32	TYPE			SUBMIX	A	B	C	D	E	F	G	H
	P	1		PAN								
	A	2		SEND1								
	R	3		SEND2								

Synthesizer
MODEL K4/K4r

MIDI Implementation Chart

Date: Aug. 1989
Version: 1.0

Function ...		Transmitted	Recognized	Remarks
Basic Channel	Default Changed	1—16 1—16	1—16 1—16	Memorized
Mode	Default Messages Altered	— X * * *	1, 3 OMNI ON/OFF	Memorized MONO ignored
Note Number	: True Voice	24—108 * * *	0—127 0—127	
Velocity	Note ON Note OFF	* *	* *	
After Touch	Key's Ch's	X *	X *	
Pitch Bender		*	*	
Control Change	1	*	*	Modulation
	7	X	*	Volume
	64	*	*	Hold 1
	101, 101 6	* (0, 1) *	* (0, 1) *	RPC Data entry
Prog Change	: True #	* ***	* 0—127	
System Exclusive		*	*	
System Common	: Song Pos : Song Sel : Tune	X X X	X X X	
System Real Time	: Clock : Commands	X X	X X	
Aux Messages	: Local ON/OFF : All Notes OFF : Active Sense : Reset	X ○ (123) ○ X	○ ○ (123-127) ○ X	
Notes	* Can be set to ○ or X Memorized even after turning off the power RPC #0=Pitch Bender sensitivity #1=Master fine tuning Values are given by Data entry			

Mode 1 : OMNI ON, POLY
Mode 3 : OMNI OFF, POLY

Mode 2 : OMNI ON, MONO
Mode 4 : OMNI OFF, MONO

○ : Y
X : N

OPTION DATA

INDEX

A		DECAY (DRUM)	68
AFTERTOUC (DCA)	49	DELAY (S-COMMON)	43
AFTERTOUC (DCF)	53	DRUM DECAY	68
AFTERTOUC (DCO)	36, 47	DRUM FACTORY SETTING	92'
AFTERTOUC (LFO)	41, 43, 47	DRUM INST COPY	69
AM	31, 35	DRUM KEY No.	68, 92
ATTACK (DCA)	48	DRUM MANUAL PLAY	16
ATTACK (DCF-MOD)	55	DRUM SUB MIX CH (EFFECT/OUTPUT)	68
AUTO BEND DEPTH	38	DRUM RCV CH	67
AUTO BEND KS TIME	38	DRUM TUNE	68
AUTO BEND TIME	37	DRUM VELO DEPTH	67
AUTO BEND VEL DEPTH	39	DRUM VOLUME	67, 68
		DRUM WAVE	68
B		DUMP	82
1→2 BAL	72	DUMP REQUEST	89
BENDER RANGE	36		
BLANK CHART	92	E	
		EDIT DRUM	67
C		EDIT EFFECT (K4)	72
CARD	26	EDIT MULTI	60
COARSE	46	EDIT OUTPUT (K4r)	72
COMMON	34	EDIT SINGLE	32
COMPARE	28	EFFECT	24, 71
COMPUTER USE	88	EFFECT FACTORY SETTING	92'
CONFIGURATION OF DRUM	66	EFFECT SUB MIX CH EDIT	73
CONFIGURATION OF EFFECT	24, 71	EFFECT TYPE (K4)	72, 74
CONFIGURATION OF K4	24	EFFECT PATCH (K4)	24, 33, 61, 71
CONFIGURATION OF MULTI	60	EFFECT PARAMETER (K4)	72
CONFIGURATION OF OUTPUT	24, 71	EFFECT SEND (K4)	24, 71
CONFIGURATION OF SINGLE	29, 91'	EFFECT DEPTH (K4)	24, 71
COPY DRUM	69	ENV DEPTH (DCF-MOD)	54
COPY FILTER	57	ERROR MESSAGES	90
COPY SOURCE	57	EXT	11, 12, 24
CUTOFF	52		
		F	
D		FACTORY SETTING (DRUM)	92'
DATA DUMP	82	FACTORY SETTING (EFFECT: K4/K4r)	92'
DC (DIGITAL CYCRIC)	31	FILTER	52
DCA	48	FILTER COPY	57
DCA-MOD	49	FINE	46
DCF	52	FIXED KEY	47
DCF-MOD	54	FORMAT (CARD)	26
DCO	46		
DECAY (DCA)	48		
DECAY (DCF-MOD)	55		

H		N	
HEADPHONES	5, 71	NAME (MULTI MODE)	61
HOLD (K4)	5	NAME (SINGLE)	33
I		O	
INDIVIDUAL OUT	71, 73	OFF VELOCITY (DCA)	51
INST OR SINGLE (MULTI MODE)	61	OFF VELOCITY (DCF)	56
INT	11, 12, 24	OMNI	79
K		OUTPUT SET	24, 33, 61, 71
KEY PRESSURE	AFTER TOUCH	P	
KEY TRACK	46	PAN (EFFECT)	24, 71
KEYBOARD SCALING	45	PAN (OUTPUT)	24, 71
KS CURVE	45	PARA OUT	24, 71
KS DEPTH (DCA-MOD)	50	PARAMETER REFERENCE CHART	91
KS DEPTH (DCF)	53	PATCH SELECT	11, 12, 15
L		PITCH BEND	36
LAYER	13, 85	POLY MODE	35
LEVEL (DCA)	48	PRESS (FREQ)	36, 47
LEVEL (MULTI MODE)	64	PRESS DEPTH (DCA-MOD)	49
LFO (DCF)	42	PRESSURE	AFTER TOUCH
LFO (DCO)	VIBRATO	PREV (PREVIOUS)	28
LFO DELAY (DCF)	42	PROGRAM CHANGE	20, 78, 79, 88
LFO DEPTH (DCF)	42	PROTECT	27
LFO PERSS DEPTH (DCF)	43	R	
LFO SHAPE (DCF)	42	RCV CH (DRUM)	67
LFO SPEED (DCF)	42	RCV CH (MULTI MODE)	63
LINK PLAY	15	RCV CH (SYSTEM)	79
LINK SET	15	RECALL	28
LOAD FROM CARD	27	RELEASE (DCA)	49
LOCAL (SYSTEM)	77, 83	RELEASE (DCF-MOD)	55
M		RELEASE VELOCITY (DCA)	51
MIDI	18	RELEASE VELOCITY (DCF)	56
MIDI DATA DUMP	82	REL VEL	RELEASE VELOCITY
MIDI EXCLUSIVE ON/OFF	80	RESONANCE	53
MIDI IMPLEMENTATION CHART	95	S	
MIDI OMNI	79	S-COMMON	43
MIDI RCV	79	SAVE TO CARD	27
MIDI RCV CH (SYSTEM)	79	SECTION MUTE	60
MIDI TRS	78	SECTION SELECT	60
MIDI TRS CH	78	SEQUENCE PLAY	17, 83, 88
MODULATION WHEEL	5, 37	SINGLE (MULTI MODE)	61
MULTI PLAY	12, 83, 85	SINGLE PLAY	11

SOURCE COPY	57	VIBRATO DEPTH	41
SOURCE MODE	34	VIBRATO PRESS DEPTH	41
SOURCE MUTE	32	VIBRATO SHAPE	40
SOURCE SELECT	32	VIBRATO SPEED	40
SPLIT	13, 86	VOLUME (DRUM)	67
STRUCTURE	34	VOLUME (MULTI MODE)	61
SUB MIX CH	24, 33, 71	VOLUME (SINGLE MODE)	33
SUB MIX CH (DRUM)	68	VOLUME (UNIT)	5
SUB MIX CH (MULTI MODE)	64		
SUB MIX CH EDIT (EFFECT)	73	W	
SUSTAIN (DCA)	48	WAH WAH	LFO
SUSTAIN (DCF-MOD)	55	WAVE	31
SYSTEM LOCAL	77	WAVE (DRUM)	68
SYSTEM RCV	79	WHEEL ASSIGN	37
SYSTEM SYS	77	WRITE	below
SYSTEM TRANSPOSE	14	WRITE DRUM	70
SYSTEM TRS	78	WRITE EFFECT	76
SYSTEM TUNE	14	WRITE MULTI	65
SYSTEM VEL SW POINT	77	WRITE OUTPUT	76
		WRITE SINGLE	58
T			
TIME MOD VEL (ATTACK) (DCA-MOD)	50	Z	
TIME MOD VEL (ATTACK) (DCF-MOD)	56	ZONE (MULTI MODE)	62
TIME MOD KS (DCA-MOD)	51		
TIME MOD KS (DCF-MOD)	57		
TIME MOD REL VEL (DCA-MOD)	51		
TIME MOD REL VEL (DCF-MOD)	56		
TRANS (MULTI MODE)	64		
TRANSPOSE (SYSTEM)	14		
TROUBLE SHOOTING	91		
TUNE (DRUM)	68		
TUNE (MULTI MODE)	64		
TUNE (SYSTEM)	14		
V			
VALUE SET	28		
VARIABLE	60		
VEL CURVE	44		
VEL DEPTH (DCA-MOD)	49		
VEL DEPTH (DCF)	53		
VEL DEPTH (DCF-MOD)	55		
VEL SW (MULTI MODE)	63, 87		
VEL SW POINT (SYSTEM)	77		
VELOCITY	VEL		
VIB/A.BEND	47		

K4/K4r Specifications

KEYBOARD (K4)	61, WEIGHTED, w/Attack & Release Velocity and Aftertouch pressure
SOUND SYSTEM	(K4r: 2U rack-mounted digital synthesizer module)
MAX POLYPHONY	16 Bit PCM & DC WAVES (TOTAL 256 WAVES)
PROGRAM MEMORY	NORMAL:16, TWIN&DOUBLE:8 (32 SOURCES)
	INTERNAL: 128 (64 SINGLE/64 MULTI) + 61 DRUM
SINGLE EDIT	DC-16 MEMORY CARD: 128 (64 SINGLE/64 MULTI) + 61 DRUM
	EDIT VOLUME, EFFECT PATCH (OUTPUT PATCH), SUBMIX CH, NAME
	5 COMMON SOURCE MODE, AM, POLY MODE, BENDER RANGE, PRESS > FREQ, WHEEL ASSIGN, DEPTH, AUTO BEND TIME, DEPTH, KS > TIME, VEL > DEPTH
	13 LFO VIBRATO SHAPE, SPEED, DEPTH, PRESS DEPTH, DCF-LFO SHAPE, SPEED, DELAY, DEPTH, PRESS DEPTH
	6 S-COMMON DELAY, VEL CURVE, KS CURVE, COPY
	14 DCO WAVE, KEY TRACK, COARSE (FINE), FIXED KEY, PRESS on off, VIB/A.BEND on off
	7 DCA LEVEL, ATTACK, DECAY, SUSTAIN, RELEASE
	15 DCA MOD VEL DEPTH, PRESS DEPTH, KS DEPTH, TIME MOD-VEL, RELEASE VEL, KS
	8 DCF CUTOFF, RESONANCE, VEL DEPTH, PRESS DEPTH, KS DEPTH, LFO
	16 DCF MOD ENV DEPTH, VEL DEPTH, ATTACK, DECAY, SUSTAIN, RELEASE, TIME MOD-VEL, RELEASE VEL, KS
MULTI EDIT	EDIT VOLUME, EFFECT PATCH (OUTPUT PATCH) NAME
	A INST SINGLE ASSIGN
	B ZONE ZONE LO, HI, VELOCITY SWITCH
	C SEC ch RCV CH, (K4: MODE)
DRUM EDIT	D LEVEL LEVEL, TRANS, TUNE, SUBMIX CH
	DRUM DRUM: (COMMON) VOLUME, RCV CH, VEL DEPTH
	(EACH KEY) KEY, WAVE S1, S2, DECAY S1, S2, TUNE S1, S2, LEVEL S1, S2, SUBMIX CH, COPY
EFFECT EDIT	EFFECT :K4 TYPE, PARAMETER 1, 2, 3, SUBMIX CH EDIT, PAN, SEND 1, 2
SYSTEM	OUTPUT :K4r SUBMIX CH EDIT, PAN/INDIV.
	SYSTEM SYS: TUNE, TRANSPOSE, LOCAL, VEL SW POINT, LINK 1-8
	TRS: CHANNEL, PGM, (K4: PRS, BEND, MOD, HOLD, VEL)
	RCV: CHANNEL, OMNI, PGM, PRS, BEND, MOD, VOL, HOLD, VEL, EXCLUSIVE
WRITE/DUMP	WRITE DUMP WRITE, DATA DUMP, INT PROTECT, CARD PROTECT SAVE/LOAD, CARD FORMAT
FRONT AND REAR PANEL CONTROLS & jacks	VOLUME, PATCH SELECT SW, DRUM SW, EFFECT SW (K4r: OUTPUT), (K4: WHEEL X 2) WRITE SW, POWER SW, DC IN, OUTPUT STEREO L/R (MONO) (K4r: +1-6), PHONE jack, CARD SLOT, MIDI IN/OUT/THRU
DISPLAY	16 x 2 LCD backlit
DIMENSIONS (mm)	K4: 1020 (W) x 310.8 (D) x 88.5 (H), K4r: 483 (W) x 218.5 (D) x 88 (H)
WEIGHT	K4: 7.3 kg, K4r: 2.8 kg
POWER CONSUMPTION	K4: 5.8 W, K4r: 6.8 W

Free Manuals Download Website

<http://myh66.com>

<http://usermanuals.us>

<http://www.somanuals.com>

<http://www.4manuals.cc>

<http://www.manual-lib.com>

<http://www.404manual.com>

<http://www.luxmanual.com>

<http://aubethermostatmanual.com>

Golf course search by state

<http://golfingnear.com>

Email search by domain

<http://emailbydomain.com>

Auto manuals search

<http://auto.somanuals.com>

TV manuals search

<http://tv.somanuals.com>