

Digital Piano

KSP 5/10/30

OWNER'S MANUAL

Basic Operation

KAWAI

A NOTE OF THANKS

Thank you for choosing a
Kawai KSP Series Digital Piano.

Your new Kawai KSP Series digital piano is a truly innovative instrument offering the very latest in leading-edge music technology. Its development relied upon Kawai's long years of experience and success in the manufacture of musical instruments.

A diverse array of 128 (129: KSP30) instrument sounds, 64 rhythms for a wide range of pleasing styles, and a powerful auto orchestra capability give you the musical resources to create exciting "full band" performances with just your own two hands!

This manual explains the basic procedures for operating your new KSP Series piano. We urge you to read it carefully -- before you begin to play -- to help ensure optimal use of the instrument's powerful features.

Enjoy your new piano ... and thank you again for choosing Kawai!

TABLE OF CONTENTS

STARTING TO PLAY	2
PLAYING DIFFERENT SOUNDS	4
PLAYING DRUM SOUNDS	6
USING THE PEDAL	7
USING THE REVERB FUNCTION	8
PLAYING RHYTHMS	10
PERFORMING WITH AUTO ORCHESTRA	12
ADJUSTING AUTO ORCHESTRA VOLUME	14
LISTENING TO A DEMO PERFORMANCE	15

STARTING TO PLAY

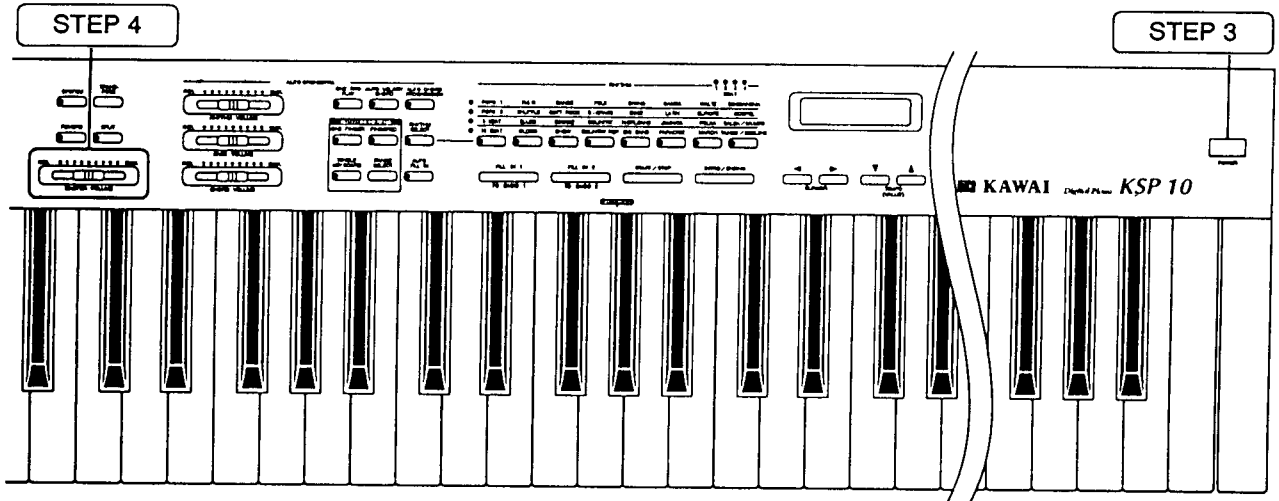

STEP 1 Insert the female end of the AC power cord into the multi-prong AC IN jack on the rear of the unit as shown in the figure at the right.

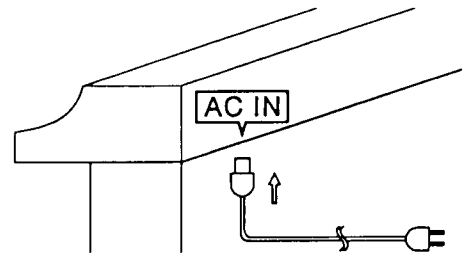

STEP 2 Insert the plug end of the AC power cord into the wall outlet.

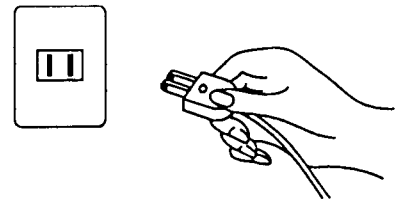

STEP 3 Press the power switch to turn the unit ON.

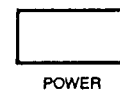

STEP 4 Adjust the volume with the MASTER VOLUME slide control.

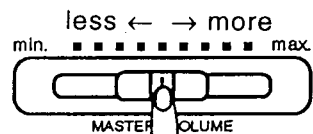

STEP 5 Start playing.

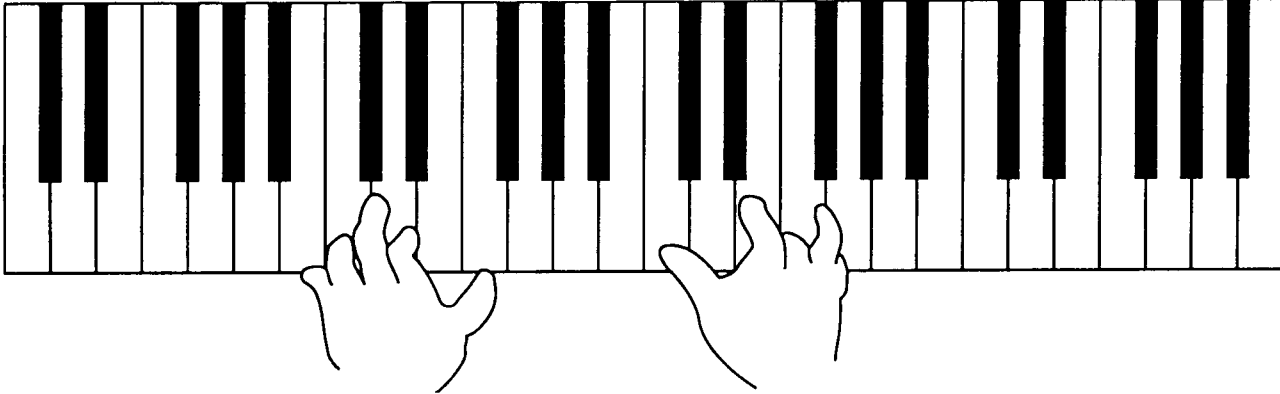

You will hear a beautifully realistic piano sound.

KSP10 / 30

• Setting up the music stand

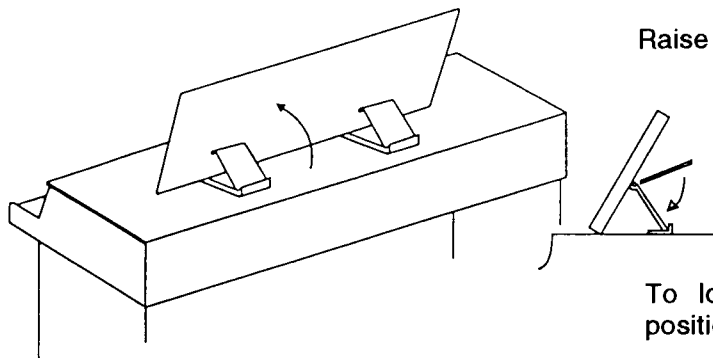

Raise the music stand up towards you.

Now set the metal fixture as shown in the figure so the music stand will not fall.

To lower the stand back to the horizontal position, raise the metal fixture.

• Listening with headphones

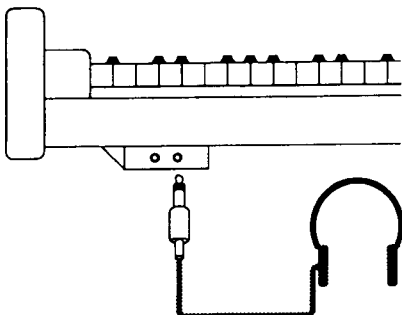

Two headphone terminals are located at the left, under the keyboard as shown. Plugging in the headphones will cut off sound from the main speakers. This feature is convenient for practice at night or other times when you do not wish to disturb people around you.

Note: Two pairs of headphones can be connected simultaneously. (KSP10 / 30)

PLAYING DIFFERENT SOUNDS

A variety of other sounds can be played. Try playing some of them.

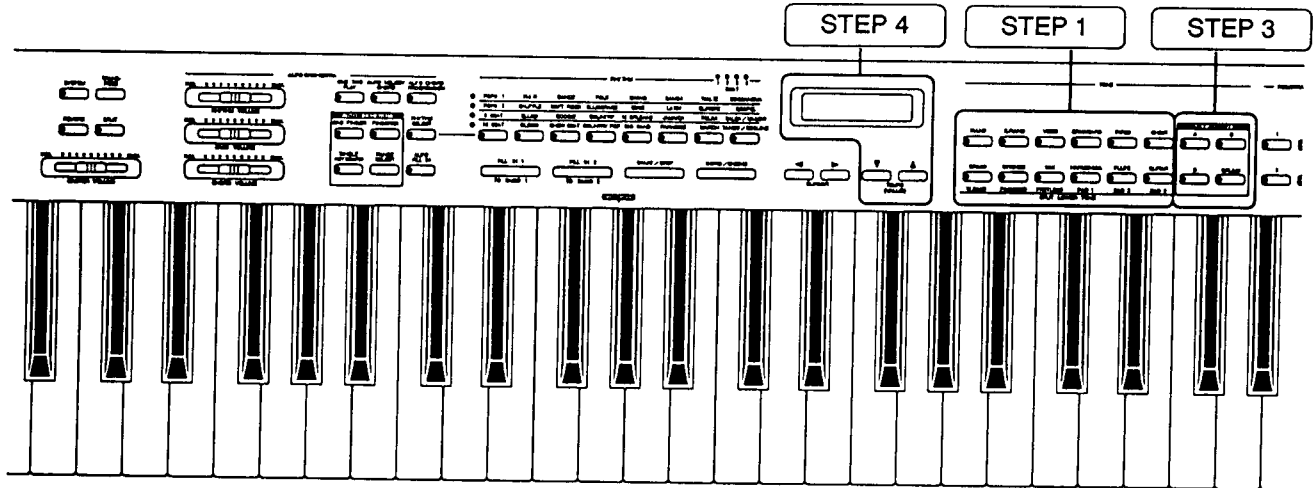

STEP 1 Press the button for a sound you would like to hear.

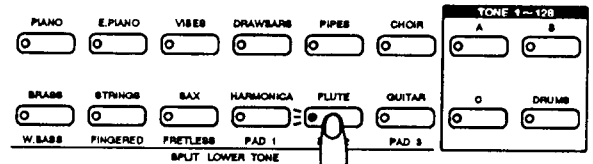

In this case, the sound of a flute was chosen. The sound name is shown at the top of the display.

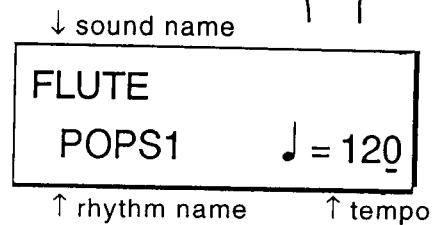

STEP 2 Try pressing some keys.

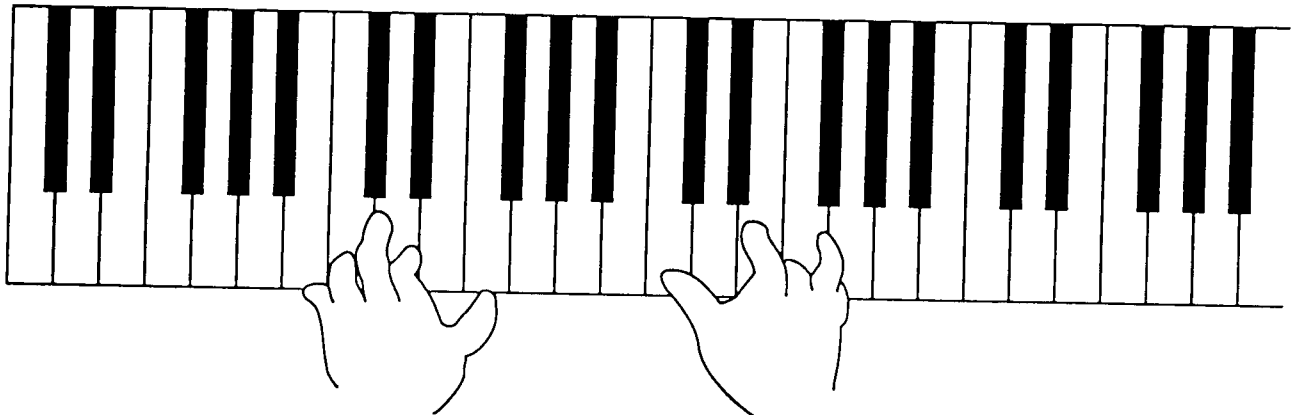

A flute sound can be heard.

STEP 3

Press either the A, B or C button when selecting a sound not on the panel display.

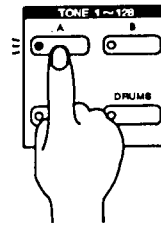

When the A button is pressed, the alto sax sound is chosen and shown in the display.

066 ALTO SAX
POPS1 ♩ = 120

STEP 4

Press the TEMPO (VALUE) button several times while watching the display. Notice that the sounds change. When the button is held down, the numbers change in increments of 10.

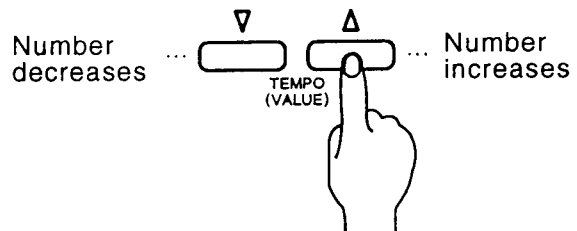

Select the sound you want from a total of 128 sounds, numbering from 001 to 128. In this case, oboe (sound No. 69) was chosen. (Refer to the sound chart on the back cover page of the Auto Chord Progression Chart.)

069 OBOE
POPS1 ♩ = 120

STEP 5

Try pressing some keys.

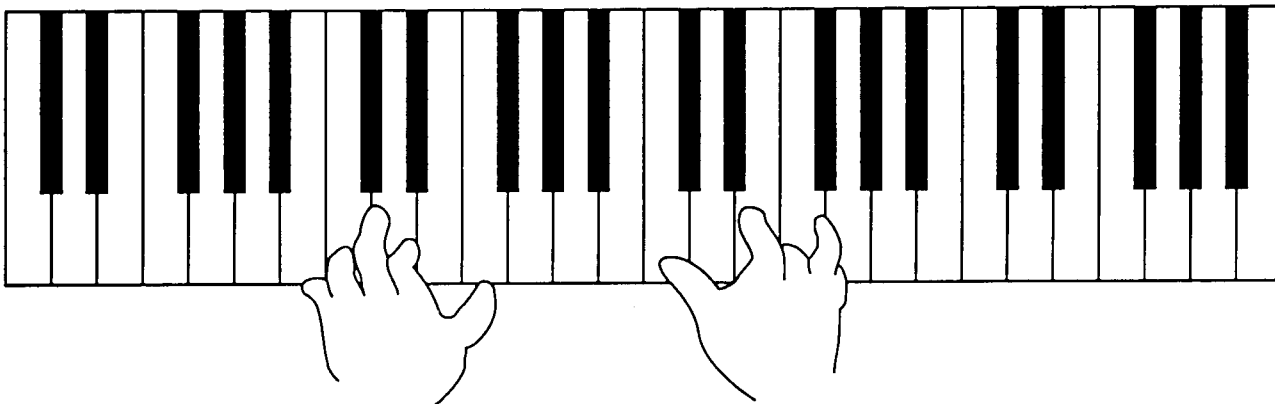

An oboe sound can be heard.

PLAYING DRUM SOUNDS

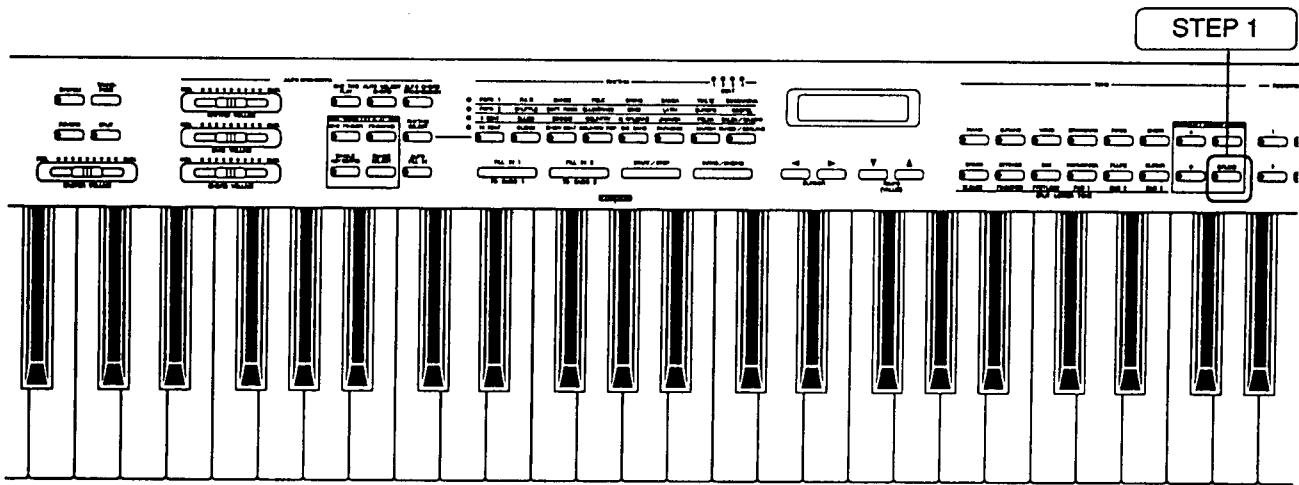

STEP 1 Press the DRUMS button.



STEP 2 Try pressing a key.

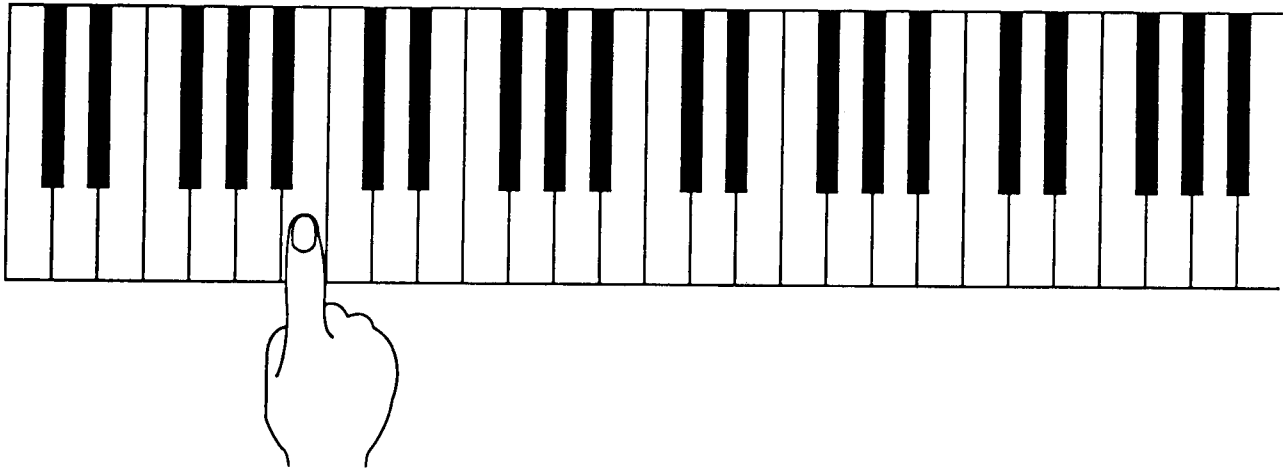

Every key that is pressed will cause a different drum/percussion sound to be heard.

Note: Different combinations of drum sets can be selected.
(Refer to page 8 of the Advanced Operation.)

USING THE PEDAL

- KSP30 pedal arrangement

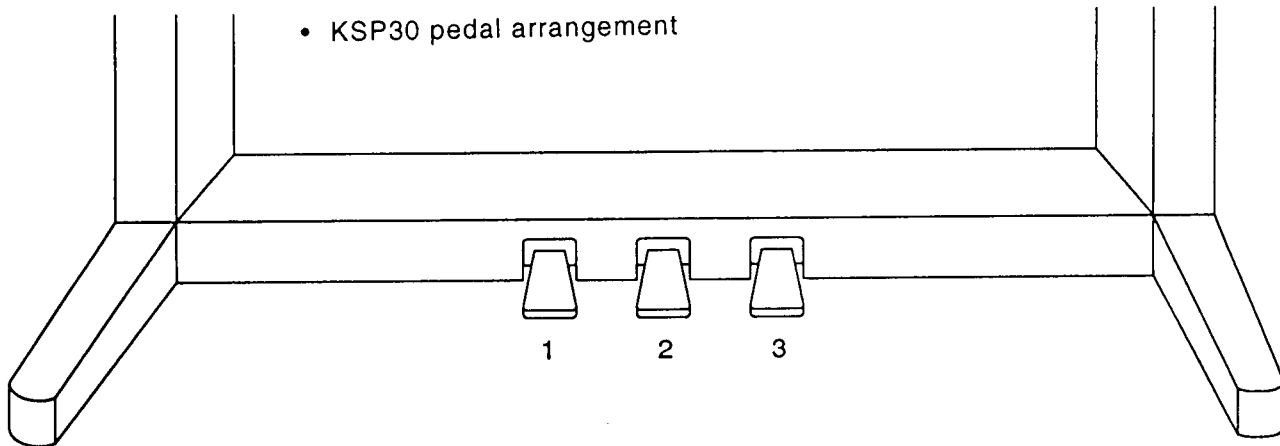

- KSP5 / 10 Pedal arrangement

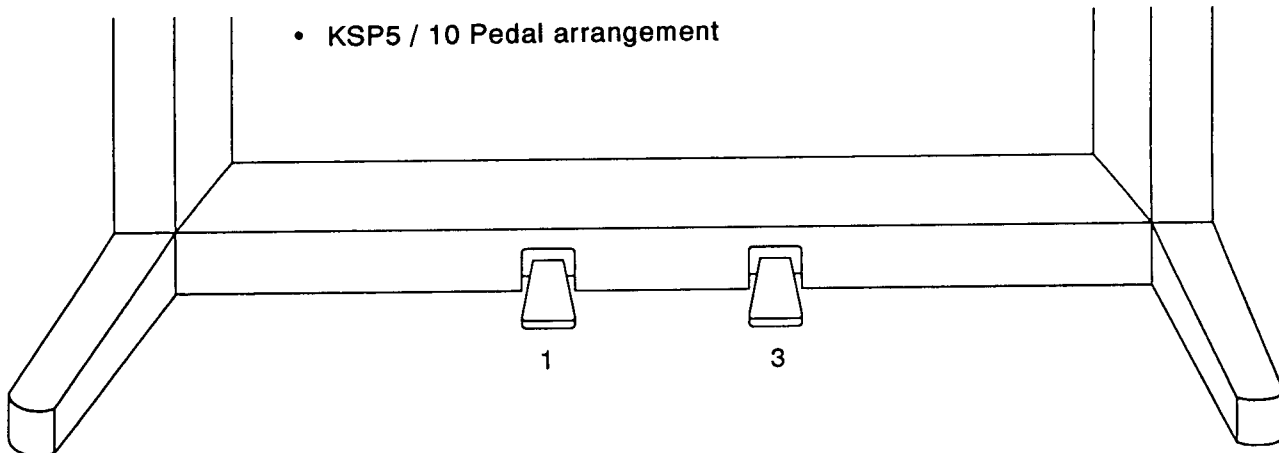

- 1 Left PedalPressing the left pedal softens the sound. Various other functions can also be assigned to this pedal.
(Refer to page 34 of the Advanced Operation.)
- 2 Sostenuto Pedal ... Pressing this pedal while a key is still being held down by a finger (KSP30 only) activates the sustain function for that sound only.
- 3 Damper Pedal Pressing this pedal activates the sustain function. This function can be separately controlled for the upper and lower keyboards.
(Refer to page 35 of the Advanced Operation.)

USING THE REVERB FUNCTION

You can use the reverb function in your performance. The reverb function adds a residual echo effect to the sound, providing a richer and deeper feeling to the music.

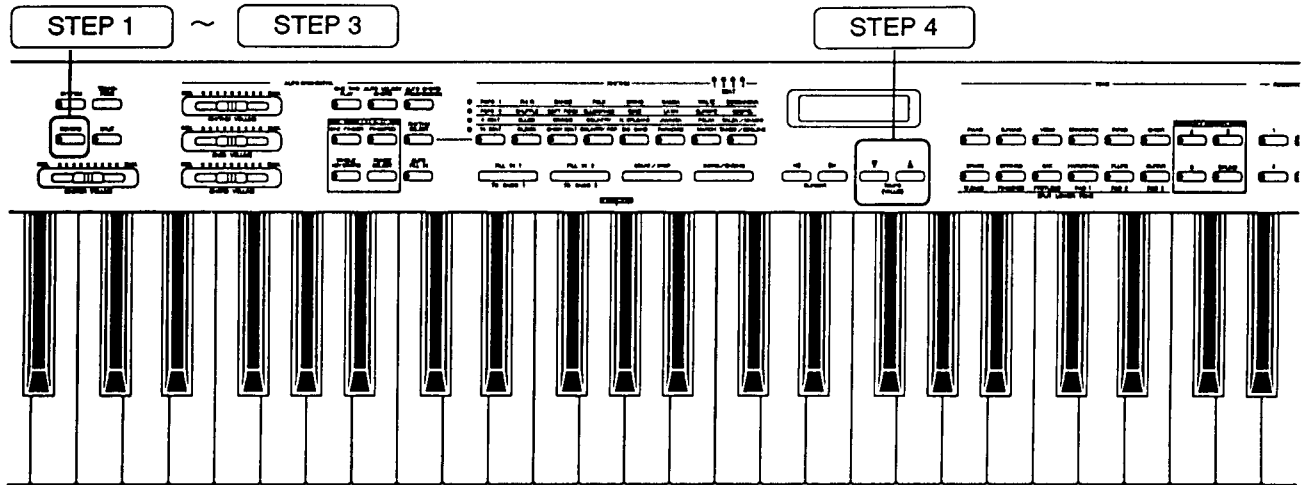

STEP 1 The reverb effect is activated when the REVERB lamp is lit.
(The reverb effect is automatically activated when the power is turned on.)



STEP 2 Pressing the reverb button turns off the REVERB lamp and cancels the reverb effect.



STEP 3 Pressing the reverb button again lights the REVERB lamp, and the reverb effect is again activated. For a few seconds, the display shows the message in the figure on the right.
(If you don't proceed to Step 4, the display will return to normal after about 3 seconds.)



REVERB TYPE
= LARGE ROOM

STEP 4

Pressing the TEMPO (VALUE) button repeatedly at this time (while the display is changed) allows you to select the type of reverb you desire.
(The display will return to normal about 3 seconds after you've selected a reverb setting.)

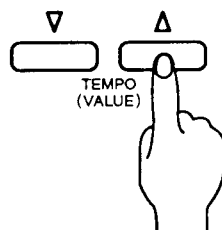

REVERB TYPE
= HALL

Types of reverb and their effects are as listed below.

- SMALL ROOM Gives a reverb sound similar to playing in a small room with a pronounced echo effect.
- LARGE ROOM Gives a deeper reverb sound than when playing in the above SMALL ROOM.
- HALL Gives a reverb sound similar to playing in a small concert hall.
- CHURCH Gives a reverb sound similar to playing in a large concert hall or church.
- COSMIC Gives a reverb sound that creates an image of "wide and open" spaces.
- DELAY Gives a reverb sound like a delayed echo.

STEP 5

Play the keys and experience the reverb effect.

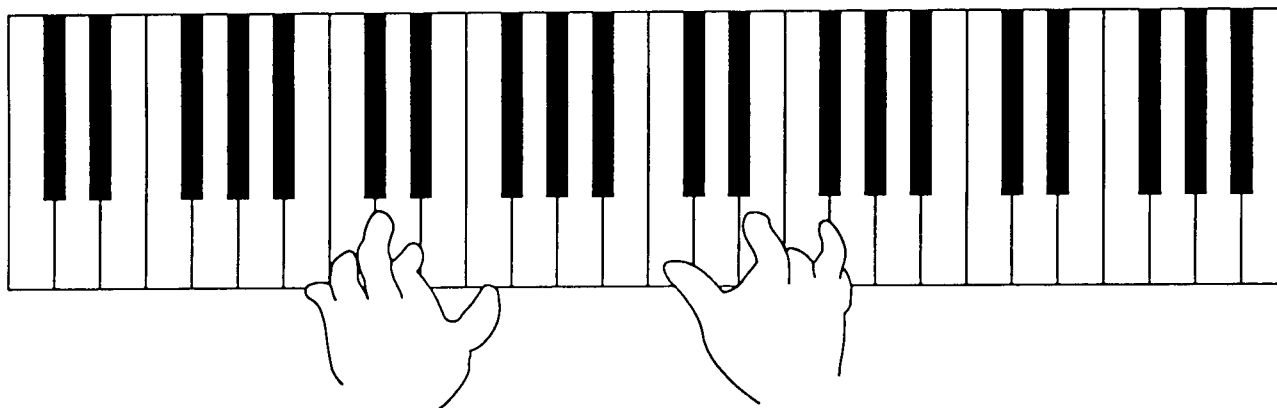

PLAYING RHYTHMS

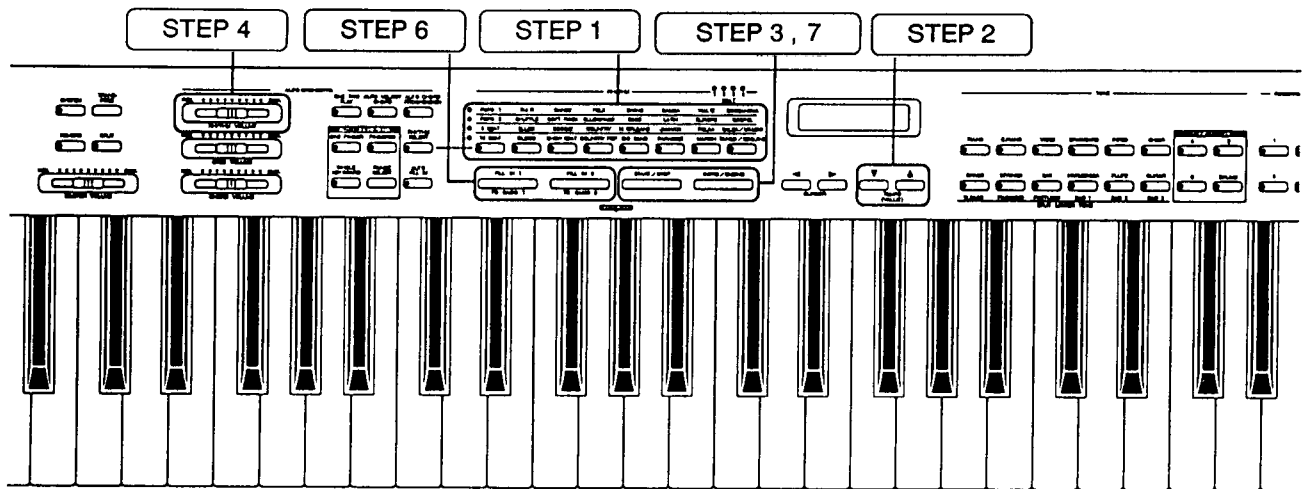

STEP 1

Select a favorite rhythm with the rhythm buttons. For instance, to select COUNTRY, press the button below COUNTRY several times.

Its lamp will light as shown in the figure on the right. The rhythm name is shown in the display.

In addition, pressing the RHYTHM SELECT button while COUNTRY is still displayed allows selection of an additional COUNTRY rhythm. Pressing the RHYTHM SELECT button again turns off the lamp and returns you to the original country rhythm.

POPS 1	R & R	DANCE	FOLK	SWING	SAMBA	WALTZ	BOSSANOVA
POPS 2	SHUFFLE	SOFT ROCK	B - GRASS	DIXIE	LATIN	EUROPE	GOEPEL
8 BEAT	BLUES	BOOGIE	COUNTRY	N. ORLEANS	JAMAICA	POLKA	SALSA / MAMBO
16 BEAT	OLDIES	SHOW	COUNTRY POP	BIG BAND	PARADISE	MARCH	TANGO / BEGUINE

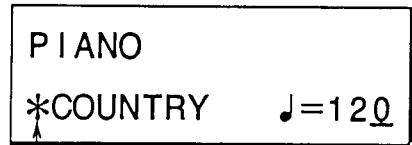

This mark will then be displayed.

This function allows you to select two types of patterns for each rhythm name.

STEP 2

Adjust the speed of the rhythm (tempo). Press the TEMPO (VALUE) button to adjust the tempo as needed.

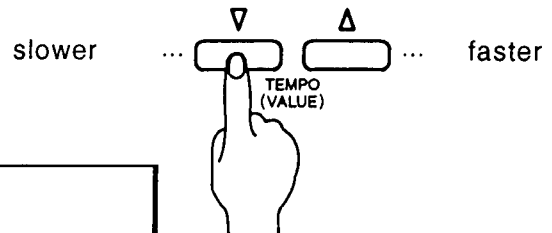

STEP 3

Start the rhythm.
Basic pattern 1 (BASIC 1) is automatically selected.

- Press the START/STOP button to start the rhythm immediately.
- Press the INTRO/ENDING button to start the intro before the rhythm begins.

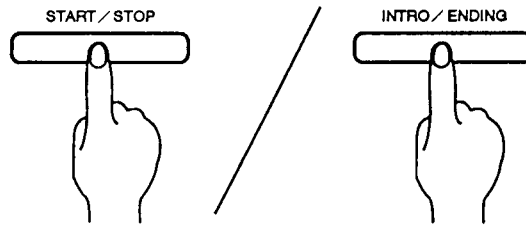

STEP 4

Adjust the rhythm volume.
Adjust as needed with the RHYTHM VOLUME slide control.

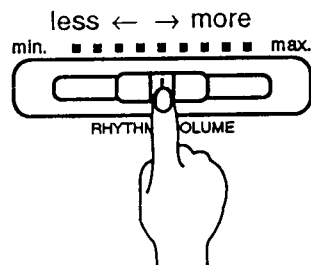

STEP 5

Play in time with the rhythm.

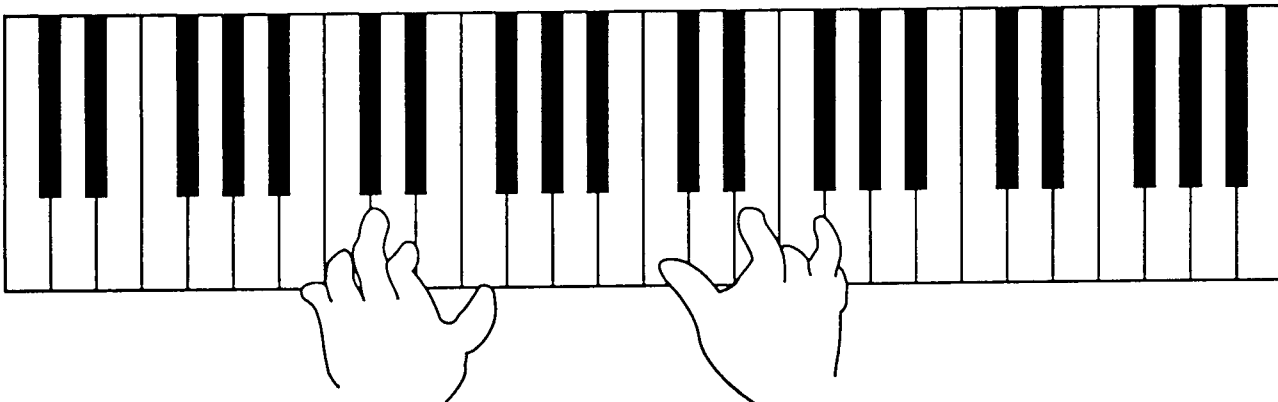

STEP 6

To make a change in the rhythm (FILL IN):

Press FILL IN 1 to change to basic pattern 1 (BASIC 1).

Press FILL IN 2 to change to basic pattern 2 (BASIC 2).

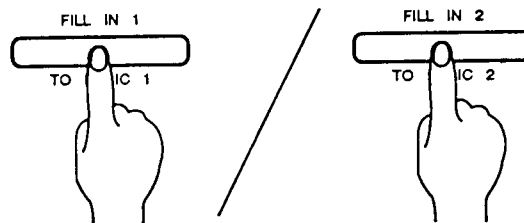

STEP 7

Stop the rhythm.

- Press the START/STOP button to stop the rhythm immediately.
- Press the INTRO/ENDING button to play the "Ending" pattern.

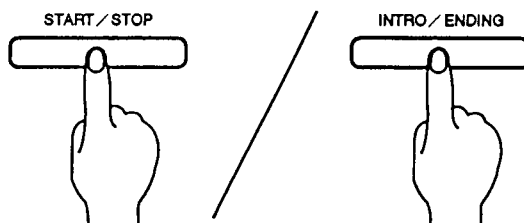

PERFORMING WITH AUTO ORCHESTRA

The Auto Orchestra (Auto Accompaniment) function allows an accompaniment pattern to automatically play in time with the rhythm by just specifying the left-hand chords.

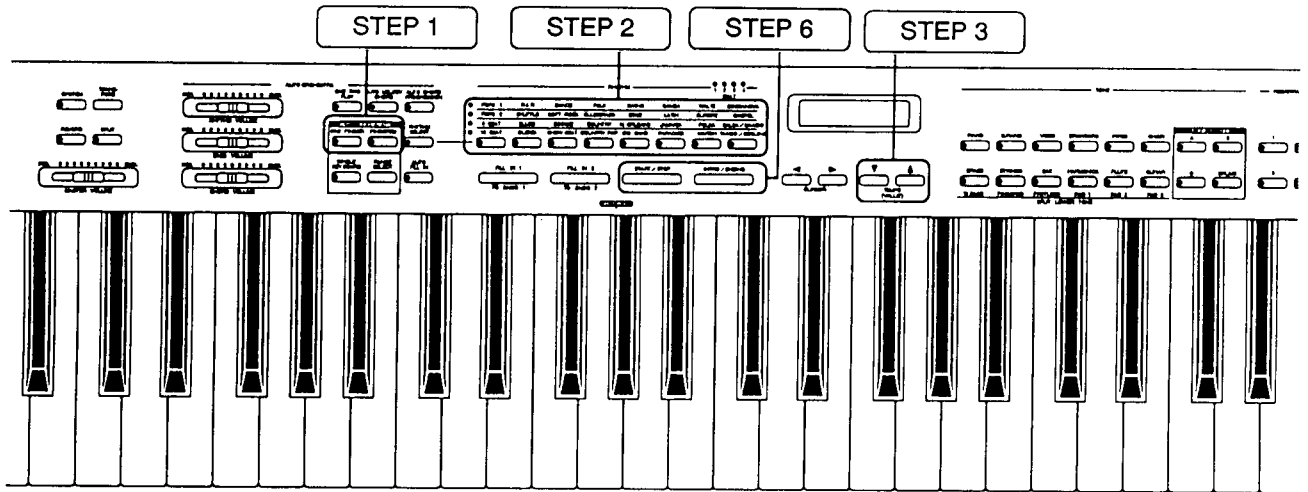

STEP 1 Press the **ONE FINGER** button or the **FINGERED** button.



or

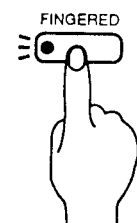

- When the **ONE FINGER** button is pressed

Auto Orchestra is controlled with just one finger, so full left-hand chords do not have to be pressed. For instance, you can choose a major chord with just one finger and choose other types of chords (minor, seventh, etc.) by pressing down keys with more than two fingers.

- When the **FINGERED** button is pressed

Auto Orchestra is controlled by pressing the usual chords with the left hand. (Refer to Chord Form on page 44 of the Auto Chord Progression Chart.)

STEP 2 Select a favorite rhythm with the rhythm buttons.

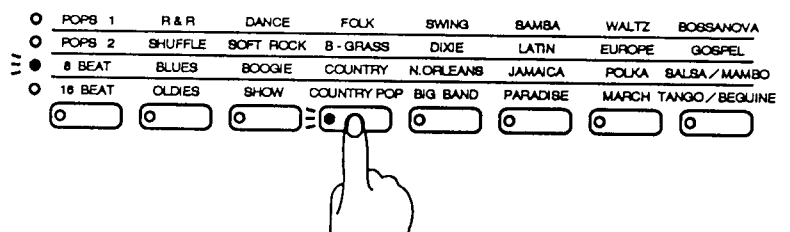

STEP 3

Adjust the speed of the rhythm (tempo). Press the TEMPO (VALUE) button to adjust the tempo as needed.

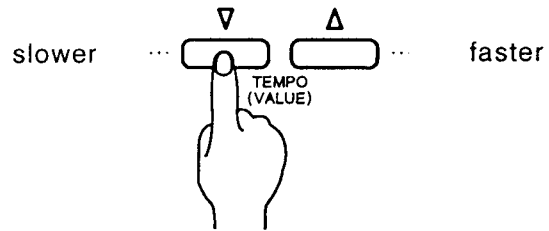

STEP 4

Start the accompaniment.

Auto Orchestra starts when a left-hand chord is pressed.

As shown in the figure on the right, hold down chords on the left side of the keyboard using the keys located to the left of the position labeled as the [SPLIT POINT].

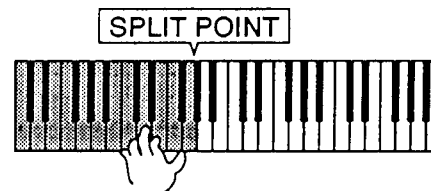

Note: Auto Orchestra will not start when selecting the DRUMS sound. Start Auto Orchestra after selecting sounds other than the DRUMS sound.

STEP 5

Play a melody with your right hand in time with the accompaniment.

Play the keys with your right hand as shown in the figure on the right, using keys to the right of the position labeled as the [SPLIT POINT].

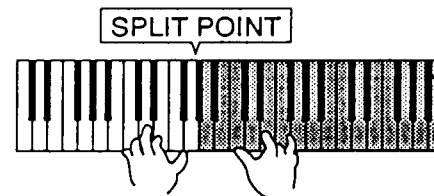

STEP 6

Stop the accompaniment. Press the START/STOP button or the INTRO/ENDING button.

Cancel Auto Orchestra by pressing the ONE FINGER or the FINGERED button. The matching lamp will turn off. The original display then reappears.

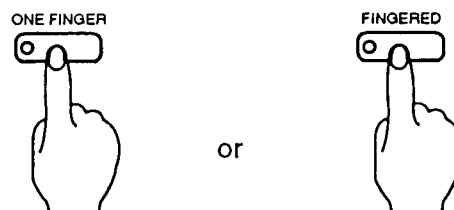
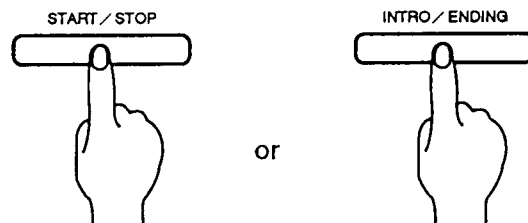

ADJUSTING AUTO ORCHESTRA VOLUME

The volume of each Auto Orchestra part can be adjusted.

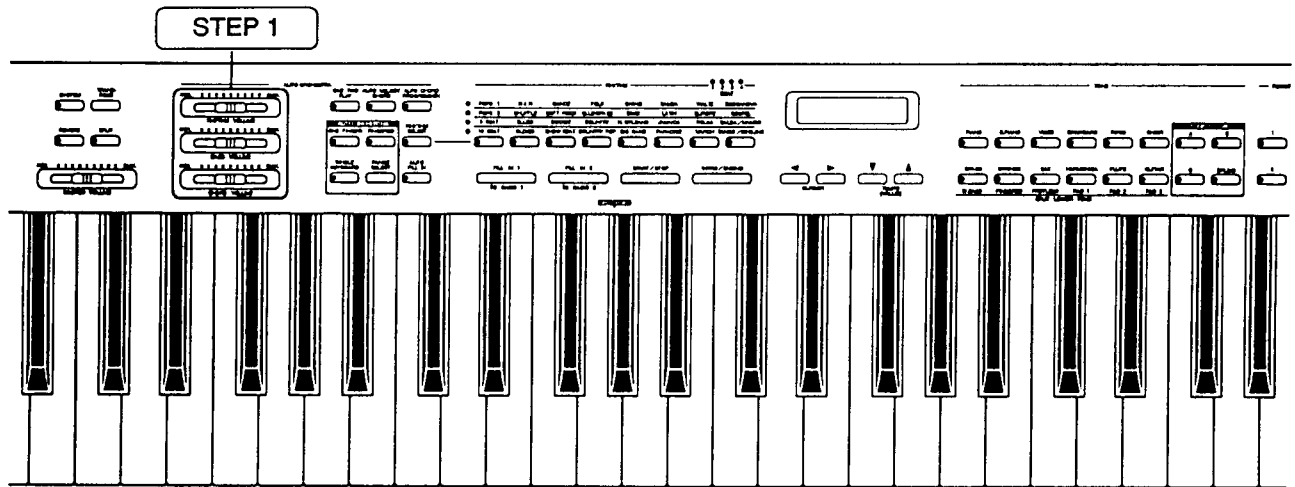

STEP 1 Operate the volume control for each Auto Orchestra part.

- Adjust the drum/percussion volume as desired with the RHYTHM VOLUME control.

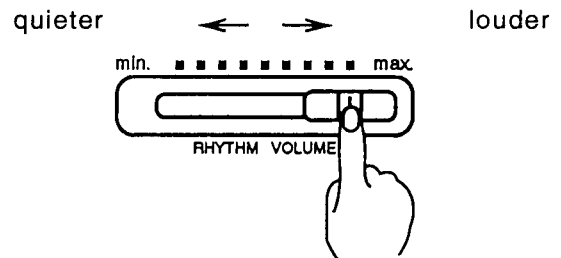

- Adjust the bass volume as desired with the BASS VOLUME control.

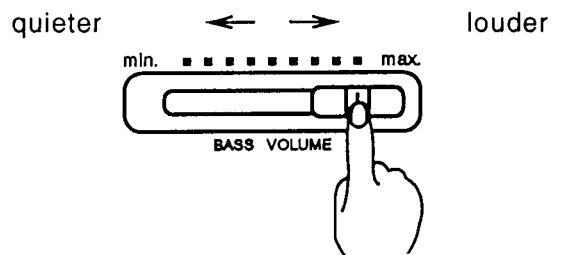

- Adjust the chord volume as desired (for sounds such as piano background) with the CHORD VOLUME control.

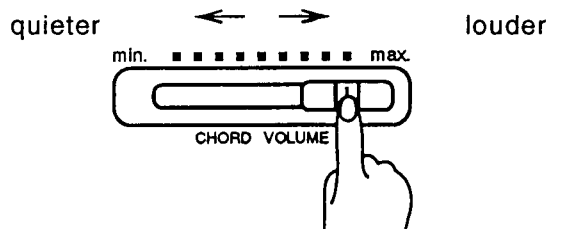

- Note:**
- No sound can be heard when the controls are moved all the way to the left.
 - When the master volume control is set to a low level, the sound will not increase even when the individual volume controls are increased.

LISTENING TO A DEMO PERFORMANCE

This digital piano has been equipped with a demonstration performance. Listen to the demo performance and experience the fine sounds available for your own performance.

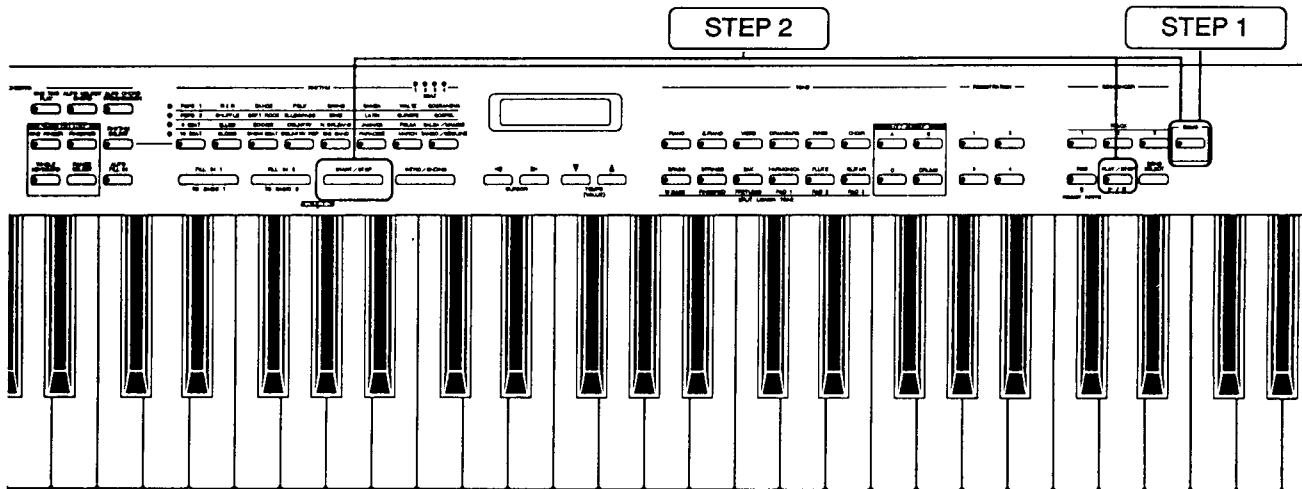

STEP 1

Press the DEMO button.
The demo performance will begin.

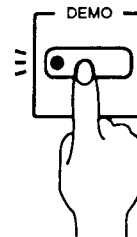

DEMONSTRATION
Quit by [DEMO] key

Note:

- During a demo performance some panel buttons may not function when pushed.
- During a demo performance the keys will not produce sound when pressed.

STEP 2

The demo performance will stop when either the demo button, the START/STOP button or the PLAY/STOP button are pressed.

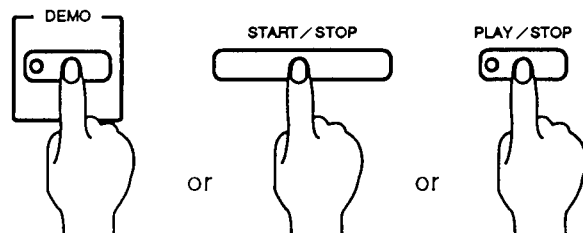

KAWAI

**Kawai Musical Instruments Manufacturing Co.,Ltd.
200 Terajima-cho, Hamamatsu, Japan**

OW926E-L 英基礎編

Printed in Japan

Free Manuals Download Website

<http://myh66.com>

<http://usermanuals.us>

<http://www.somanuals.com>

<http://www.4manuals.cc>

<http://www.manual-lib.com>

<http://www.404manual.com>

<http://www.luxmanual.com>

<http://aubethermostatmanual.com>

Golf course search by state

<http://golfingnear.com>

Email search by domain

<http://emailbydomain.com>

Auto manuals search

<http://auto.somanuals.com>

TV manuals search

<http://tv.somanuals.com>