

KAWAI MIDI KEYBOARD

MIDI KEY II

MDK 61 II

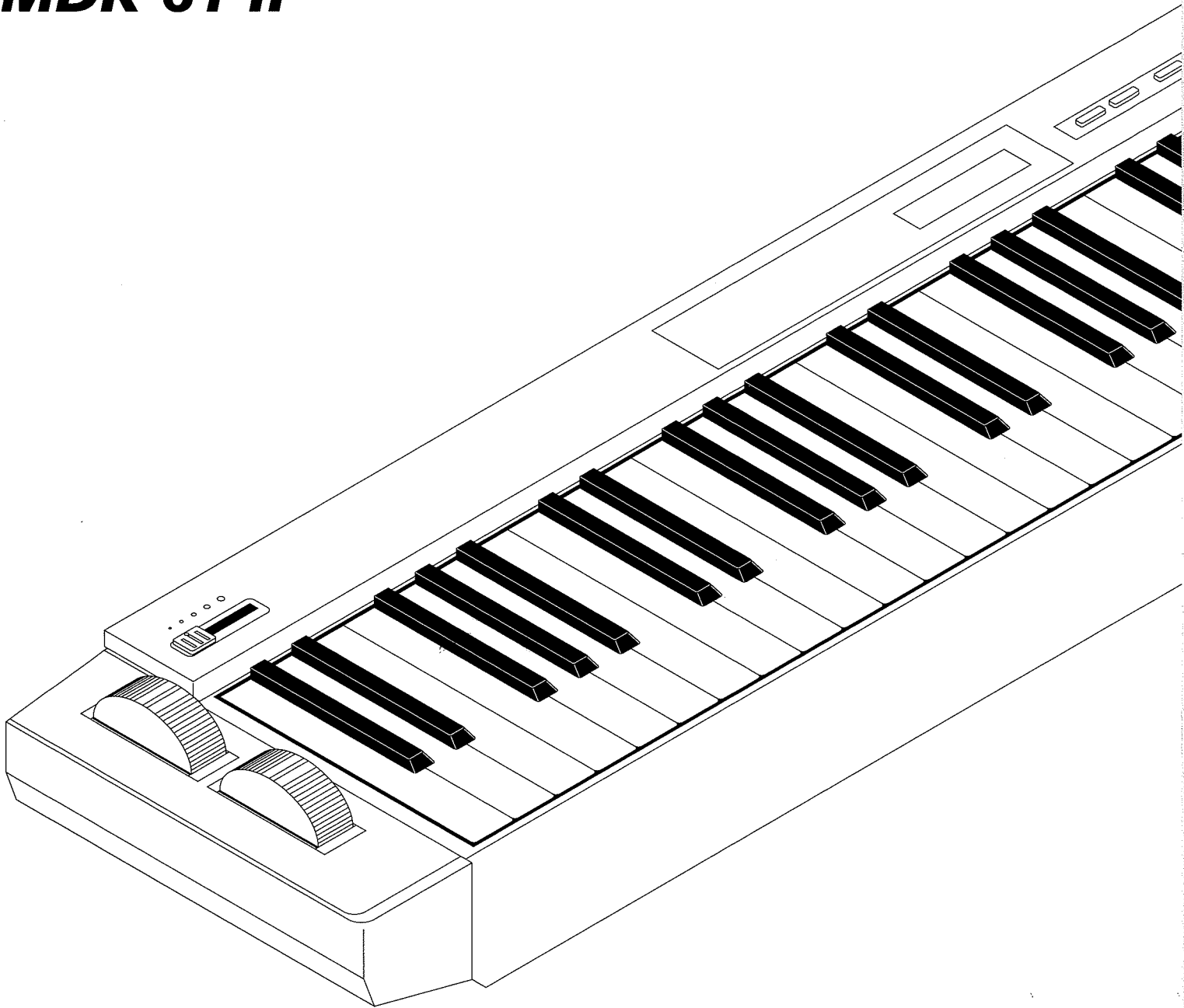

Owner's Manual

NOTE: This equipment has been tested and found to comply with the limits for a class B digital device, pursuant to Part 15 of the FCC Rules. These limits are designed to provide reasonable protection against harmful interference in a residential installation.

This equipment generates, uses and can radiate radio frequency energy and, if not installed and used in accordance with the instructions, may cause harmful interference to radio communications. However, there is no guarantee that interference will not occur in a particular installation. If this equipment does cause harmful interference to radio or television reception, which can be determined by turning the equipment off and on, the user is encouraged to try to correct the interference by one or more of the following measures:

- Reorient or relocate the receiving antenna.
- Increase the separation between the equipment and receiver.
- Connect the equipment into an outlet on a circuit different from that to which the receiver is connected.
- Consult the dealer or an experienced radio/TV technician for help.

This digital apparatus does not exceed the Class B limits for radio noise emissions from digital apparatus set out in the Radio Interference Regulations of the Canadian Department of Communications.

■ Thank you for purchasing the Kawai MIDI keyboard MDK61 II "MIDI KEY II"!

This Owner's Manual contains valuable information that will help you make full use of this instrument's many capabilities. Read it carefully and keep it handy for future reference.

■ FEATURES

1. **Complete MIDI Controls in Slim & Compact Body**

61-note velocity sensitive keyboard, 2 WHEELS, 10 numeric, 4 function switches, and LED are all provided in MIDI KEY II's small body. These allow you to quickly and easily control any MIDI messages.

2. **Support for MIDI Bank Select**

MIDI standards can handle 12,384 (128 x 128) banks, each composed of 128 program. The MIDI KEY II can send full pairs consisting of a MSB for the bank (control change No. 0) of 0 to 127 and a LSB for the bank (control change No. 32) of 0 to 127, enabling selection of all bank numbers.

3. **Assignable Controller WHEEL**

Functions such as control change, pressure, and key velocity can be assigned to this WHEEL.

4. **10 Selectable VELOCITY CURVES**

The MIDI KEY II has 10 VELOCITY CURVES. Select any of them according to your playing style and the response of your tone module.

5. **Advanced PROGRAM CHANGE Transmission**

In accordance with the new MIDI specifications, the MIDI KEY II is able to transmit PROGRAM CHANGE 0 – 127. The PROGRAM MEMORY function enables you to send a specified PROGRAM CHANGE by pressing just one switch.

■ Care and Maintenance

Proper Care

Your MIDI KEY II is a delicate musical instrument. To prevent breakdowns and ensure years of reliable, trouble-free service, shield it from:

- Direct sunlight and exposure to the elements
- Extremes in temperature or humidity
- Dusty environment
- Vibration...especially during transport

Power Supply

- Use only AC adaptor shipped with the MIDI KEY II and connect it only to a power supply with a voltage within the limits stated on the ratings plate on the backs.
- Make sure that all power switches are off before changing equipment connections.
- Check all equipment connections before applying the power.
- Do not connect to the same circuit as a heavy load or equipment that generates line noise.

Line Noise Reset

The high-speed microprocessor at the core of the MIDI KEY II is extremely sensitive to line noise and sudden fluctuations in the supply voltage. Should it "lock up" under such conditions, simply turn the MIDI KEY II's power off for a few seconds and then reapply the power.

Cleaning

- Clean the instrument with a soft cloth, a mild detergent, and lukewarm water.
- Never use harsh or abrasive cleansers or organic solvents.

Battery Backup

The lithium battery that protects the memory contents while the power to the unit is off is good for more than five years of normal use. We recommend, however, that you have your nearest authorized service representative replace it promptly after five years.

CONTENTS

FEATURES	1
Care and Maintenance	2
CONTENTS	3
Name of Parts	4
1. Preparation before Using	6
2. Setting the MIDI TRANSMIT channel (MIDI CH)	7
3. VOLUME SLIDER	8
4. BENDER (PITCH BEND) WHEEL	8
5. Selecting a VELOCITY CURVE (VEL CURVE)	9
6. WHEEL ASSIGN (WHEEL)	10
7. OCTAVE SHIFT	11
8. TRANSPOSE	13
9. Sending a PROGRAM CHANGE number (PROG)	14
10. PROGRAM MEMORY	15
11. Bank Select	15
12. GM RESET	17
SPECIFICATIONS	20
MIDI IMPLEMENTATION CHART	21

Name of Parts

● Top View

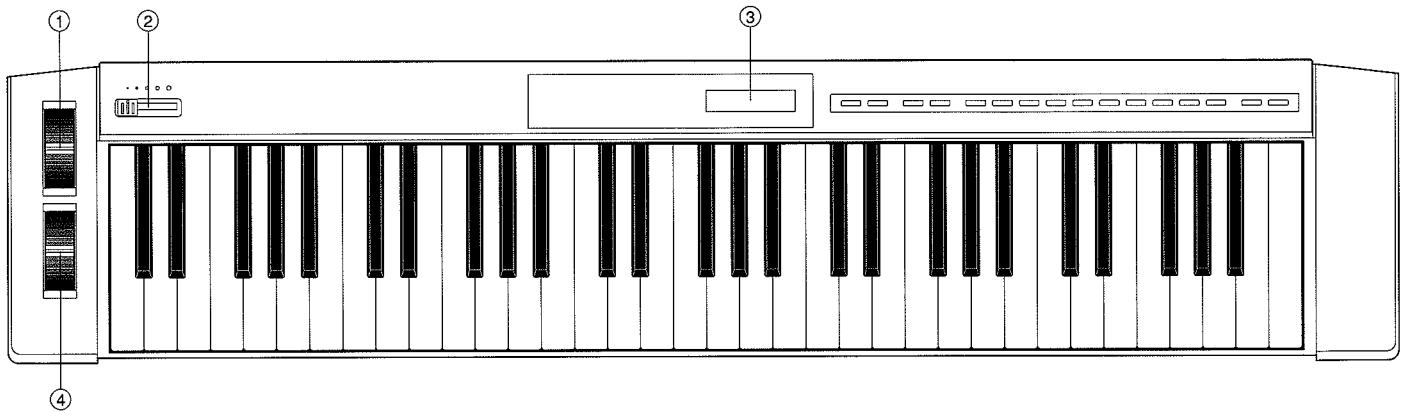

● Switches

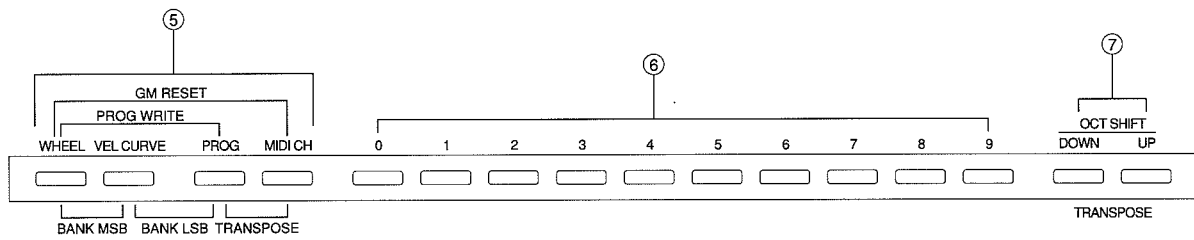

● Rear View

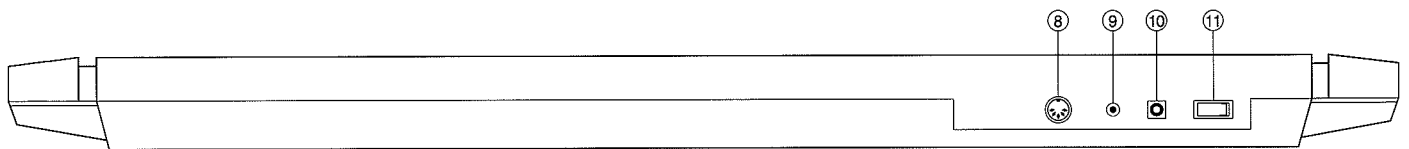

① **WHEEL**

The control information on p.10 is assigned to this WHEEL.

② **VOLUME SLIDER**

Sends MIDI VOLUME messages to control the volume level of connected MIDI instruments. (See p.8 "VOLUME SLIDER".)

③ **DISPLAY (LED)**

Shows any function number and its value, and the status of OCTAVE SHIFT. (p.11)

④ **BENDER (PITCH BEND) WHEEL**

Sends MIDI PITCH BEND messages to connected MIDI instruments. (See p.8.)

⑤ **Function Switches**

These are pressed to set various functions (BANK, TRANSPOSE, or WHEEL assignments; VELOCITY CURVE settings; PROGRAM NUMBER transmission; MIDI TRANSMIT channel; PROGRAM MEMORY; or GM reset).

⑥ **Numeric Keys (0 – 9)**

Used to set the value for all functions, and to send PROGRAM MEMORY numbers. (See p.15 "PROGRAM MEMORY".)

⑦ **UP/DOWN (TRANSPOSE) switches**

Used to set the TRANSPOSE value (→p.13), and to shift the MIDI KEY II's pitch one octave higher and lower. (See p.11 "OCTAVE SHIFT".)

⑧ **MIDI OUT Jack**

Outputs all of MIDI KEY II's MIDI messages. Use a MIDI cable to connect the MIDI KEY II to other MIDI devices.

⑨ **HOLD Jack**

When an optional foot switch (ex: Kawai F-1) is connected, the MIDI KEY II sends MIDI DAMPER messages when the switch is actuated, similar to the damper pedal of an acoustic piano.

⑩ **DC IN Jack**

Used to connect the AC adaptor.

⑪ **POWER Switch**

Turns the MIDI KEY II's power on and off.

1 Preparation before using

Step 1 Connect the MIDI KEY II and other MIDI equipments.

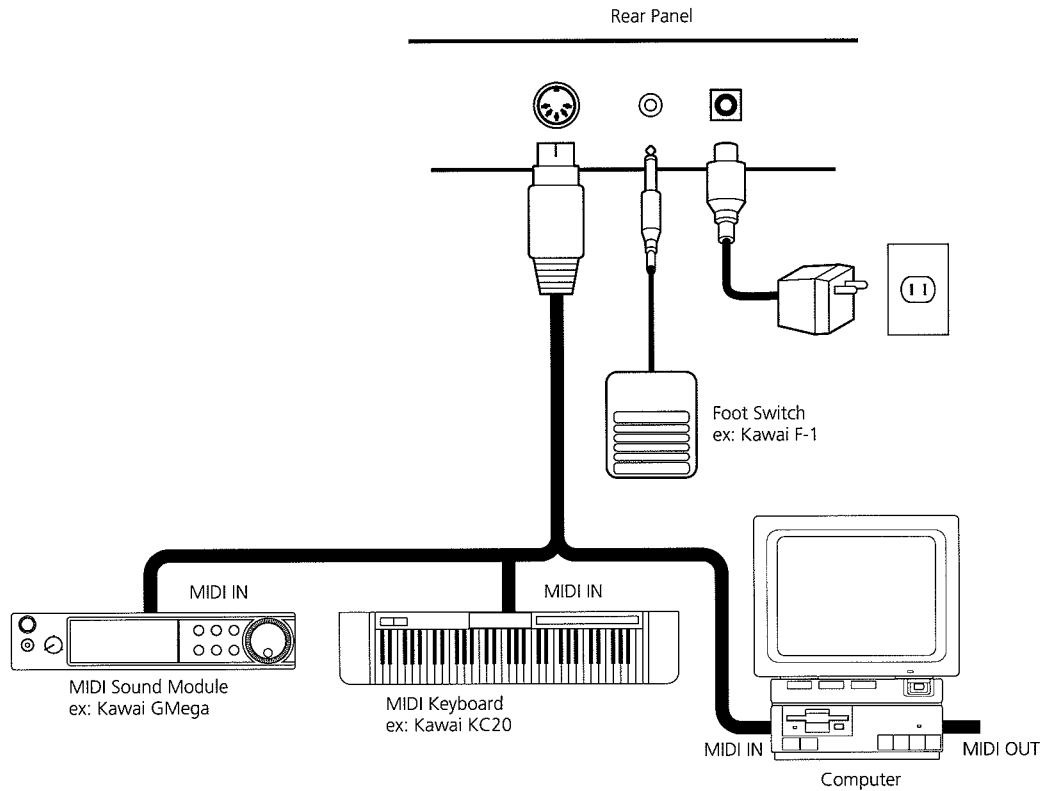

Step 2 Turn the MIDI KEY II's power on.
LED (display) shows as follows.

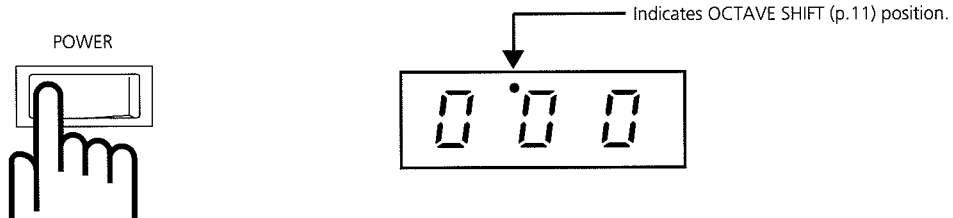

Step 3 Turn all other equipments' power on.

2 Setting the MIDI TRANSMIT channel (MIDI CH)

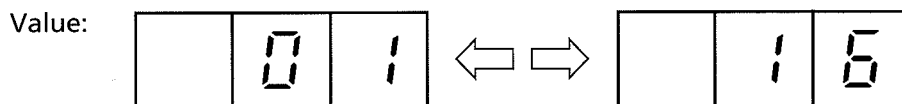

First set the MIDI KEY II's MIDI TRANSMIT channel.

The MIDI KEY II sends all MIDI messages on this MIDI channel.

Be sure to match the channel with the RECEIVE channel of connected equipment.

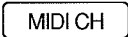
Step 1 Hold down  switch and....
(LED starts to flash showing the TRANSMIT channel now set on MIDI KEY II.)

Step 2 Press one (or two) of the numeric keys to change the channel.

<Examples>

● CH2

MIDI CH

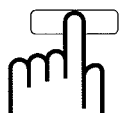

While holding down the MIDI CH switch...

2



Press 2 key.

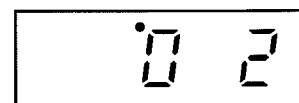

● CH16

MIDI CH

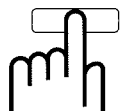

While holding down the MIDI CH switch...

1

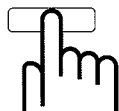

6

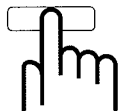

Press 1 and 6 keys successively.

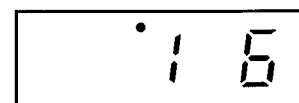

LED changes to the pressed number.

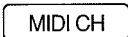
Step 3 Release the  switch.
Now the new TRANSMIT CHANNEL is set on MIDI KEY II.
(LED returns as before pressing  switch.)

Notes

- ★ The TRANSMIT channel set here remains even if MIDI KEY II's power is turned off.
- ★ Settings for the MIDI TRANSMIT channel cannot be made while a key on the keyboard is depressed.
- ★ When changing the MIDI TRANSMIT channel, the following information for the channel before the change is transmitted.
HOLD1 = OFF
HOLD2 = OFF
Sostenuto = OFF
BENDER = 40H (central position)

3 VOLUME SLIDER

Moving the VOLUME SLIDER transmits MIDI VOLUME messages to connected equipment. This allows you to control the volume of connected device (ex: synthesizer, module) from your MIDI KEY II.

Step 1 To raise the volume:
Move the SLIDER to the right.

Step 2 To lower the volume:
Move the SLIDER to the left.

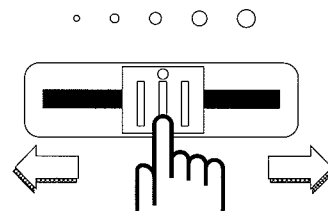

4 BENDER (PITCH BEND) WHEEL

Moving the BENDER WHEEL transmits MIDI BENDER (PITCH BEND) messages to connected equipment. This allows you to bend the pitch of sound up (or down) to personalize your performance.

Step 1 To bend up the pitch:
Move the WHEEL away from you.

Step 2 To bend down the pitch:
Move the WHEEL towards you.

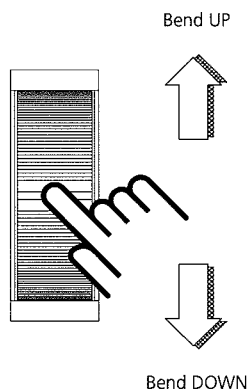

5 Selecting a VELOCITY CURVE (VEL CURVE)

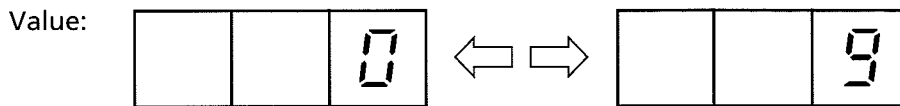

The MIDI KEY II's VELOCITY CURVES determine the relationship between how hard the keys are struck and the corresponding velocity that the MIDI KEY II transmits.

The MIDI KEY II allows you to select from 10 VELOCITY CURVES.

Step 1 Hold down the **VEL CURVE** switch and...
(LED starts to flash showing the VELOCITY CURVE now set on MIDI KEY II.)

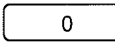
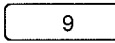
Step 2 Press one of the numeric keys ( - ) to select a VELOCITY CURVE.
The 10 key numbers correspond to the 10 VELOCITY CURVES as follows.

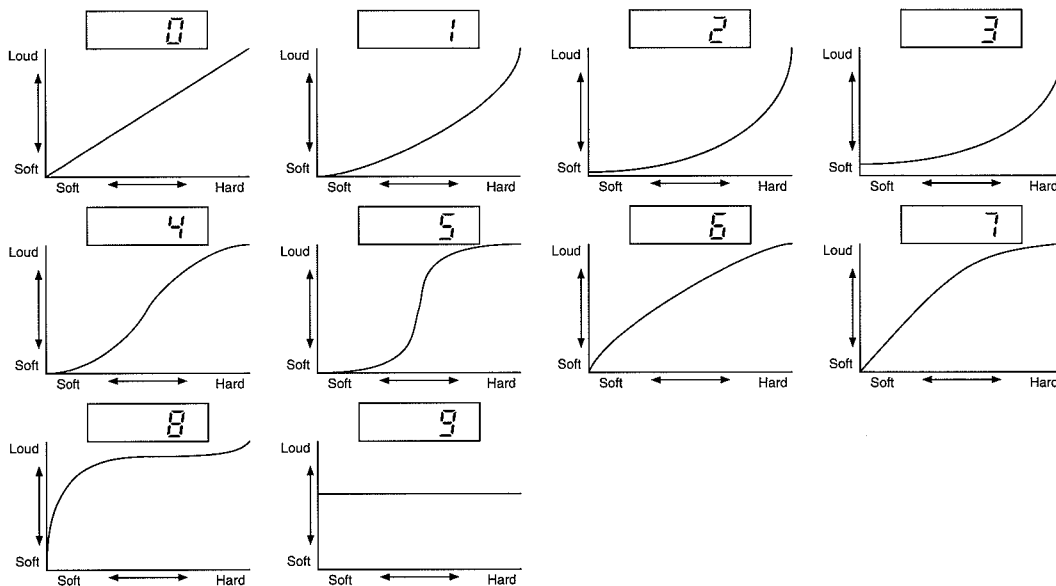
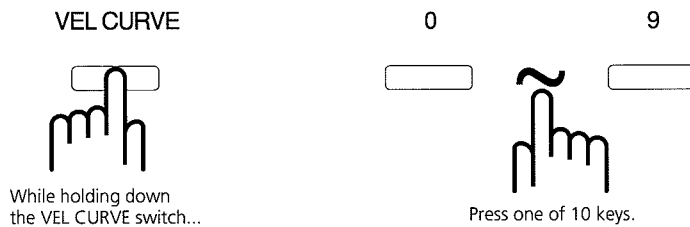

Notes

- ★ The VELOCITY CURVE set here remains even if the MIDI KEY II's power is turned to off.
- ★ The VELOCITY CURVE set here is ineffective if the "VELOCITY" function is assigned to the WHEEL. (See p.10 "WHEEL ASSIGN")

6 WHEEL ASSIGN (WHEEL)

The MIDI KEY II can assign various types of control information to the WHEEL, and then transmit that information when the WHEEL is rotated.

In this mode, rotating the WHEEL determines what kind of information is to be transmitted. The control number list on p.18 is a typical example.

Note

- ★ Settings for the following control numbers cannot be made.
0 or 32 (Bank Select)
96 to 101
122 to 127

Now let's try assigning control number 10 – PAN (pan pot) – to the WHEEL for the MIDI KEY II.

PAN (Pan Pot)

If the receiving sound source module or synthesizer is equipped with this pan pot function, the sound can be shifted to the left or right with this control information.

Step 1

While holding down the **WHEEL** switch, use the numeric keys (0-9) to input "10." The display flashes while the **WHEEL** switch is held down.

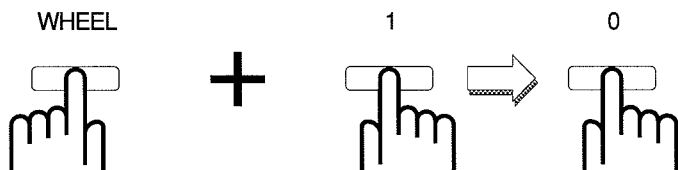

Step 2

Releasing the **WHEEL** switch completes the setting.

Notes

- ★ When setting a three-digit control number, do not release the **WHEEL** switch until the entry of the third digit has ended completely.
- ★ When the power to the unit has been turned off and then on again, the WHEEL function is set for MODULATION.
- ★ The settings that have been shown are effective only when the receiving instrument is equipped with these functions.
- ★ When setting control number 132, you can use the WHEEL to set the velocity value for the note information that is sent now.
- ★ Parameter numbers 120 (ALL SOUND OFF) and 121 (RESET ALL CONTROLLERS) are sent by rotating the WHEEL farther than its central position to enable the minimum value.

7 OCTAVE SHIFT

This shifts the pitch of the keyboard up or down by one or two octaves.

Transmission is normally within the range of note numbers 36 to 96, but the UP and DOWN switches can be used to transmission note numbers 48 to 108 and 60 to 120, or 24 to 84 and 12 to 72. The current setting for OCTAVE SHIFT is indicated by the position of the dot on the display.

Step 1 To shift the pitch one octave higher:
Press the **OCT SHIFT UP** switch once.

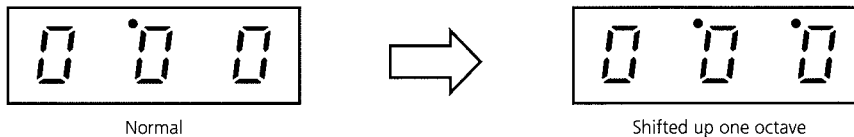

Step 2 To shift the pitch two octaves higher:
Press the **OCT SHIFT UP** switch once more.

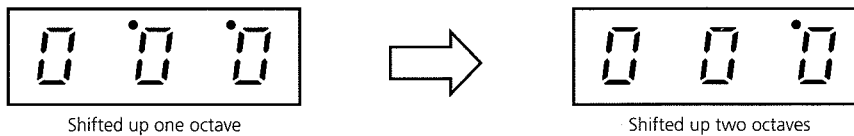

Step 3 To shift the pitch one octave lower:
Press the **OCT SHIFT DOWN** switch once.

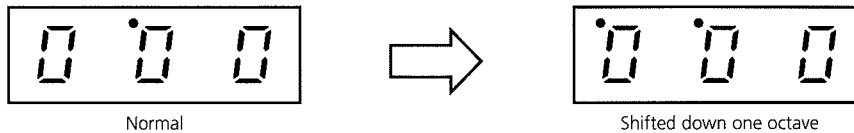

Step 4 To shift the pitch two octaves lower:
Press the **OCT SHIFT DOWN** switch once more.

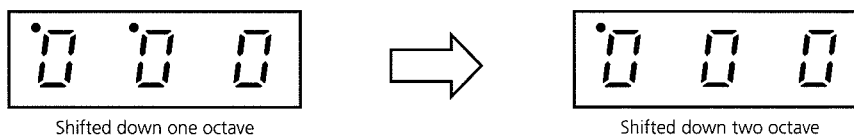

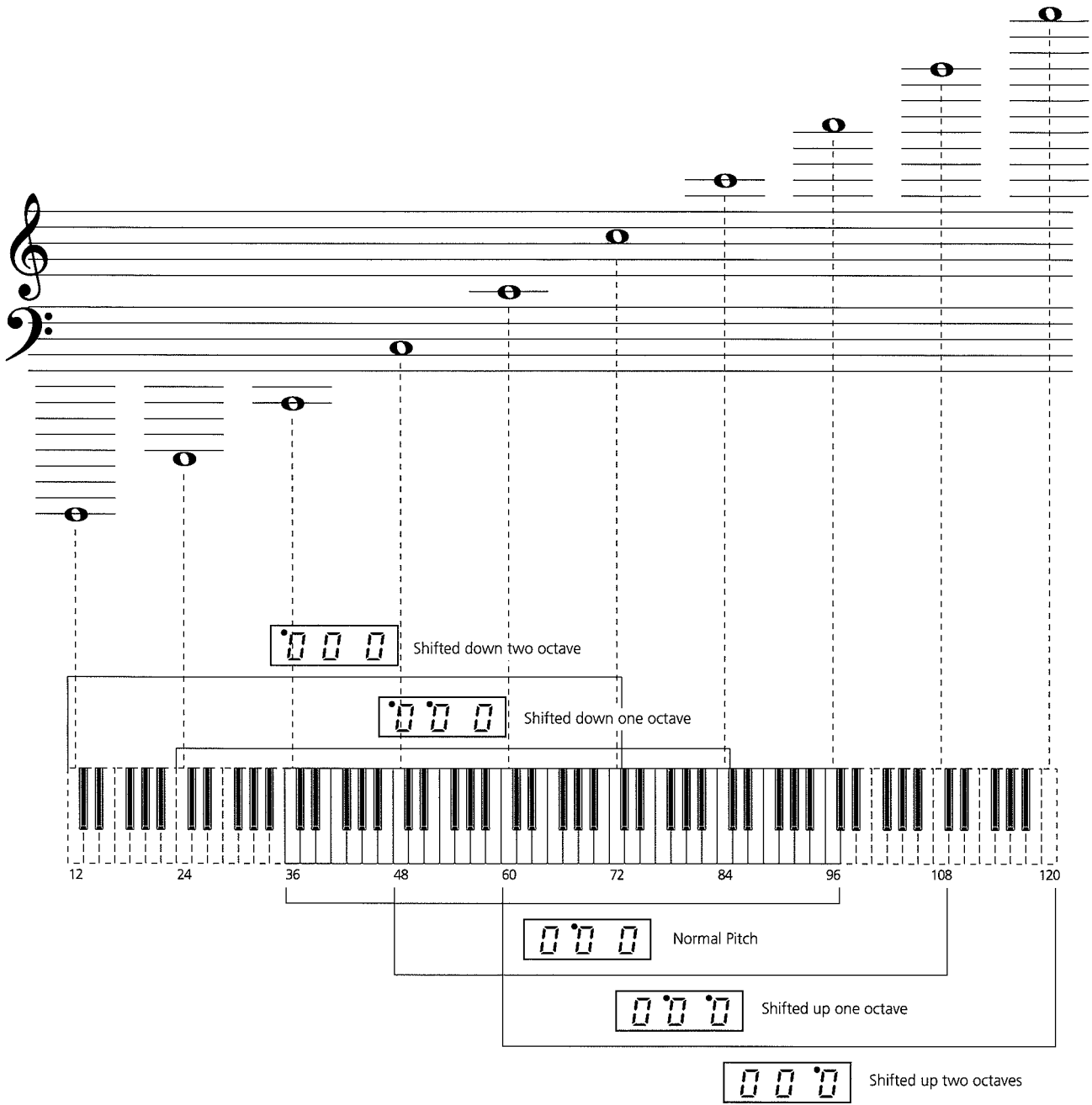

Note

★ Turning the power off always resets the shifted pitch to NORMAL pitch (dot: center of the display).

8 TRANSPOSE

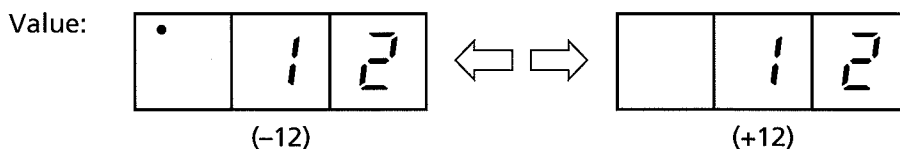

This function shifts the entire pitch of the MIDI KEY II in semitone units.

You can transpose the pitch by 24 half steps (12 higher / 12 lower). Using this function with OCTAVE SHIFT allows you to shift the MIDI KEY II's pitch by up to 72 half steps (6 octaves).

Step 1 Simultaneously press the **PROG** and **MIDI CH** switches.



Step 2 While holding down the **PROG** and **MIDI CH** switches, press the **UP** or **DOWN** switch to transpose the pitch up or down a half-step. The setting can be made within the range of 12 (+12) to -12 (-12).

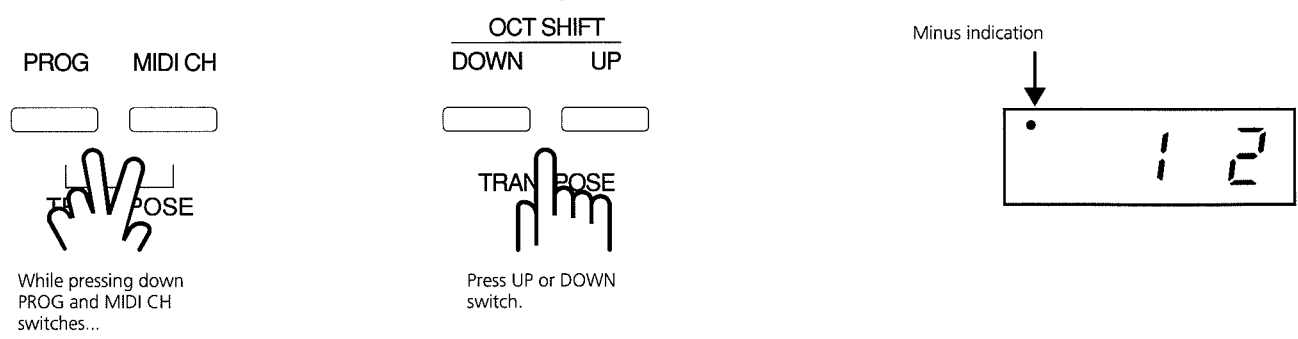

Step 3 Pressing the **PROG** and **MIDI CH** switches ends the setting.

- Notes**
- ★ A set TRANSPOSE value is reset to "0" (zero) by switching the power off and then on again.
 - ★ The TRANSPOSE setting cannot be changed while a key on the keyboard is depressed.

9 Sending a PROGRAM CHANGE number (PROG)

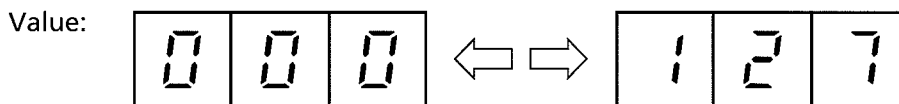

Using the  switch and the numeric keys, you can send any MIDI PROGRAM CHANGE 0 – 127

Step 1 Hold down  switch.

Step 2 Press the numeric keys to set the PROGRAM CHANGE number to be sent.

<Examples>

● PROGRAM CHANGE number 0



● PROGRAM CHANGE number 64

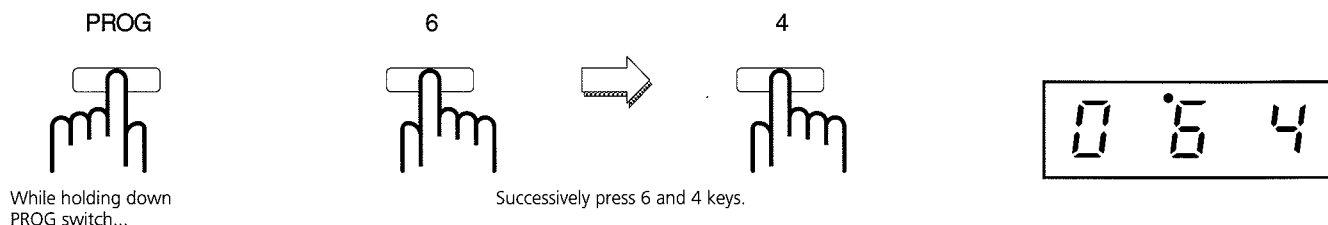

● PROGRAM CHANGE number 123

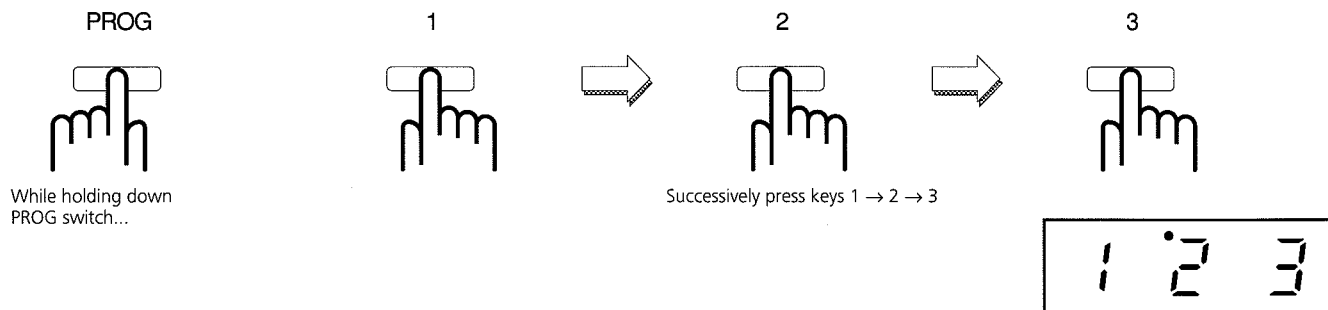

Step 3 Release the  switch.
The PROGRAM CHANGE message is sent to connected equipment.

10 PROGRAM MEMORY

You can assign a selected PROGRAM CHANGE to each of the numeric keys (0 – 9) for easy recall and transmission. Simply pressing one of the numeric keys will then send the desired PROGRAM CHANGE.

To assign a PROGRAM CHANGE number to a numeric key:

- Step 1** Select the desired PROGRAM CHANGE "9. Sending a PROGRAM CHANGE number".
- Step 2** Press the **PROG** and **WHEEL** switches at the same time.
- Step 3** While holding down the **PROG** and **WHEEL** switches at the same time, press the numeric key (0-9) to which you wish to assign the program. This assigns the program to the selected key.

(Example: To assign PROGRAM CHANGE "123" to a "2" key)

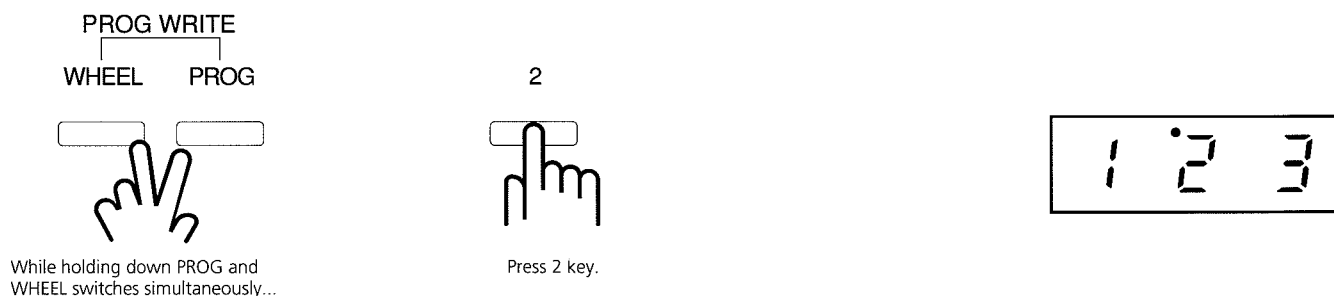

- Step 4** Release the **PROG** and **WHEEL** switches to complete the setting.

11 Bank Select

Bank Select transmits control change No. 0 (MSB) and No. 32 (LSB) as a pair. The MSB and the LSB each have 128 possible settings (from 0 to 127). This makes for 16,384 (128 x 128) available Bank Select settings.

Bank number usage varies from one manufacturer to another. Some manufacturers effect switching by varying the LSB with no change in the MSB: (0,0), (0,1),..., (0,127). Others set the LSB at 0 (zero) and effect changes by varying the MSB: (0,0), (1,0),..., (127,0).

Devices from KAWAI such as the KC20 and GMega LX are of the first type, using banks (0,0) and (0,7). For example, if you want to send bank (0,7), press the two keys for the MSB and make sure that the MSB is set to "0." Next, hold down the two keys for the LSB and use the numeric keys (0-9) to display "007," then release the LSB keys. When you do this, the MSB and LSB pair (0,7) is sent in sequence.

Now let's try choosing a bank.

First of all, connect the MIDI Key II to the KAWAI GMega LX or some other instrument with the bank function. (These specifications are effective only when the receiving instrument is equipped with the bank function.)

As we saw in the previous explanation, the KAWAI GMega LX is designed to call up banks by varying the LSB in sequence, so the LSB needs to be set.

Step 1 First, hold down the **VEL CURVE** and **WHEEL** switches at the same time, and use the numeric keys to set the MSB to "000."



Step 2 Next, hold down the **VEL CURVE** and **PROG** switches at the same time and use the numeric keys to make the setting "007."



Step 3 When the **VEL CURVE** and **PROG** switches are released, the seventh bank of the receiving instrument (the GMega LX) is called up.

Now let's try making the settings for an instrument designed to vary the MSB in sequence.

Step 1 First, hold down the **VEL CURVE** and **PROG** switches at the same time, and use the numeric keys to set the LSB to "000."



Step 2 Next, hold down the **VEL CURVE** and **WHEEL** switches at the same time and use the numeric keys to make the setting "008."



Step 3 When the **VEL CURVE** and **WHEEL** switches are released, the eighth bank of the receiving instrument is called up.

12 GM RESET

Simultaneously pressing the and switches initializes the GM function of the receiving instrument (GM ON).

To help prevent valuable settings from being reset accidentally, the reset is carried out about 2 seconds after the and switches of MIDI Key II are pressed simultaneously.

The reset has been completed when the three dots flash.

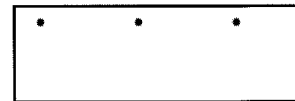

Note

★ *The function described above is effective only when the receiving instrument is equipped with the receive function for GM System On messages.*

MIDI KEY II CONTROL NUMBER LIST

GM SOUND LIST

0	Acoustic Grand Piano	32	Acoustic Bass	64	Soprano Sax	96	FX 1 (rain)
1	Bright Acoustic Piano	33	Electric Bass (finger)	65	Alto Sax	97	FX 2 (soundtrack)
2	Electric Grand Piano	34	Electric Bass (pick)	66	Tenor Sax	98	FX 3 (crystal)
3	Honky-Tonk Piano	35	Fretless Bass	67	Baritone Sax	99	FX 4 (atmosphere)
4	Electric Piano 1	36	Slap Bass 1	68	Oboe	100	FX 5 (brightness)
5	Electric Piano 2	37	Slap Bass 2	69	English Horn	101	FX 6 (goblins)
6	Harpsichord	38	Synth Bass 1	70	Bassoon	102	FX 7 (echoes)
7	Clavi	39	Synth Bass 2	71	Clarinet	103	FX 8 (sci-fi)
8	Celesta	40	Violin	72	Piccolo	104	Sitar
9	Glockenspiel	41	Viola	73	Flute	105	Banjo
10	Music Box	42	Cello	74	Recorder	106	Shamisen
11	Vibraphone	43	Contrabass	75	Pan Flute	107	Koto
12	Marimba	44	Tremolo Strings	76	Blown Bottle	108	Kalimba
13	Xylophone	45	Pizzicato Strings	77	Shakuhachi	109	Bag Pipe
14	Tubular Bells	46	Orchestral Harp	78	Whistle	110	Fiddle
15	Dulcimer	47	Timpani	79	Ocarina	111	Shanai
16	Drawbar Organ	48	String Ensemble 1	80	Lead 1 (square)	112	Tinkle Bell
17	Percussive Organ	49	String Ensemble 2	81	Lead 2 (sawtooth)	113	Agogo
18	Rock Organ	50	Synth Strings 1	82	Lead 3 (calliope)	114	Steel Drums
19	Church Organ	51	Synth Strings 2	83	Lead 4 (chiff)	115	Woodblock
20	Reed Organ	52	Choir Aahs	84	Lead 5 (charang)	116	Taiko Drum
21	Accordion	53	Voice Oohs	85	Lead 6 (voice)	117	Melodic Tom
22	Harmonica	54	Synth Voice	86	Lead 7 (fifth)	118	Synth Drum
23	Tango Accordion	55	Orchestra Hit	87	Lead 8 (bass+lead)	119	Reverse Cymbal
24	Acoustic Guitar (nylon)	56	Trumpet	88	Pad 1 (new age)	120	Guitar Fret Noise
25	Acoustic Guitar (steel)	57	Trombone	89	Pan 2 (warm)	121	Breath Noise
26	Electric Guitar (jazz)	58	Tuba	90	Pad 3 (polysynth)	122	Seashore
27	Electric Guitar (clean)	59	Muted Trumpet	91	Pad 4 (choir)	123	Bird Tweet
28	Electric Guitar (muted)	60	French Horn	92	Pad 5 (bowed)	124	Telephone Ring
29	Overdriven Guitar	61	Brass Section	93	Pad 6 (metallic)	125	Helicopter
30	Distortion Guitar	62	Synth Brass 1	94	Pad 7 (halo)	126	Applause
31	Guitar Harmonics	63	Synth Brass 2	95	Pad 8 (sweep)	127	Gunshot

CONTROL NUMBER LIST

1	Modulation Depth	69	Hold 2
5	Portamento Time	91	Ext. Effects Depth
6	Data Entry	92	Tremolo Depth
7	Volume	93	Chorus Depth
8	Balance Control	94	Celeste Depth
10	Panpot	95	Phaser Depth
11	Expression	128	Pitch Bend Sensitivity
64	Hold 1 (Damper)	129	Fine Tune
65	Portamento	130	Coarse Tune
66	Sostenuto (Chord Hold)	131	Channel Pressure
67	Soft Pedal	132	Velocity

KAWAI MIDI KEYBOARD MIDI KEY II MIDI IMPLEMENTATION

1. TRANSMITTED DATA

1st	2nd	3rd	Description	
1001nnnn	0kkkkkkk	0vvvvvvv	Note on/off	kkkkkkk= 0~127 vvvvvvv= 0 off vvvvvvv= 1~127 on
1011nnnn	00000000	0vvvvvvv	BANK Select MSB	vvvvvvv= 0~127
1011nnnn	00100000	0vvvvvvv	LSB	vvvvvvv= 0~127
1011nnnn	0ccccccc	0vvvvvvv	Control Change	ccccccc= 1~ 31 = 33~ 95 =102~119 vvvvvvv= 0~127
1011nnnn	01100100	000000vv	RPN LSB	vv= 0:Pitch Bend Sensitivity = 1:Fine Tuning = 2:Coarse Tuning
1011nnnn	01100101	00000000	RPN MSB	
1011nnnn	01111000	00000000	All Sound off	
1011nnnn	01111001	00000000	Reset all Controllers	
1100nnnn	0pppppppp	-----	Program Change	pppppppp= 0~127
1101nnnn	0vvvvvvvv	-----	Ch. Pressure	vvvvvvvv= 0~127
1110nnnn	00000000	0vvvvvvvv	Pitch Bender	vvvvvvvv= 0~127
11111110	-----	-----	Active Sensing	

nnnn=Channel no.

RPN Registered Parameter Number

2. EXCLUSIVE TRANSMITTED DATA

*Turn General MIDI System On

Status	11110000	F0H	System exclusive
ID No.	01111110	7EH	Non-Real time
device ID	01111111	7FH	
Sub-ID #1	00001001	09H	General MIDI message
Sub-ID #2	00000001	01H	General MIDI On
EOX	11110111	F7H	

SPECIFICATIONS

KEYBOARD	61 Keys (VELOCITY SENSITIVE)
CONTROLS	SWITCHES (WHEEL•VEL CURVE•PROG•MIDI CH•OCTAVE SHIFT/TRANPOSE) VOLUME SLIDER ASSIGNABLE WHEEL BENDER (PITCH BEND) WHEEL NUMERIC KEYS (0 – 9)
FUNCTIONS	SETTING THE MIDI TRANSMIT CHANNEL (1 – 16) SELECTING A VELOCITY CURVE (10 TYPES) WHEEL ASSIGN (6 FUNCTIONS) OCTAVE SHIFT (± 2 OCTAVE) TRANPOSE (± 1 OCTAVE) SENDING A PROGRAM CHANGE NUMBER (0 – 127) PROGRAM MEMORY (10 PROGRAM CHANGE NUMBERS) BANK SELECT (0 – 16383)
JACKS	DC IN, HOLD, MIDI OUT
DISPLAY	8 SEGMENT x 3 LEDS
DIMENSIONS (mm)	967 (W) x 209 (D) x 81 (H)
WEIGHT (kg)	4.0

Function . . .		Transmitted	Remarks
Basic Channel	Default Changed	1 - 16 1 - 16	Memorized
Mode	Default Messages Altered	— X *****	
Note Number	True Voice	0 - 127 *****	
Velocity	Note ON Note OFF	○ X	
After Touch	Key's Ch's	X ○	
Pitch Bend		○	
Control Change	0, 32 1 ~ 31 33 ~ 95 96 ~ 99 100, 101 102 ~ 119 120 121	○ (0 ~ 127, 0 ~ 127) ○ (0 ~ 127) ○ (0 ~ 127) X ○ (0 ~ 2, 0) ○ (0 ~ 127) ○ (0) ○ (0)	Bank select RPN All sound off Reset all controller
Program Change	True #	0 - 127 *****	
System Exclusive		*	
Common	: Song Position : Song Select : Tune	X X X	
System Real Time	: Clock : Commands	X X	
Aux Messages	: Local ON/OFF : All Notes OFF : Active Sense : Reset	X X ○ X	
Notes		* : Transmit GM system on message RPN #0 = Pitch Bender sensitivity #1 = Fine tuning #2 = Coarse tuning. Data entry MSB used for value transmission	

Mode 1 : OMNI ON, POLY

Mode 2 : OMNI ON, MONO

○ : Yes

Mode 3 : OMNI OFF, POLY

Mode 4 : OMNI OFF, MONO

X : No

KAWAI

Free Manuals Download Website

<http://myh66.com>

<http://usermanuals.us>

<http://www.somanuals.com>

<http://www.4manuals.cc>

<http://www.manual-lib.com>

<http://www.404manual.com>

<http://www.luxmanual.com>

<http://aubethermostatmanual.com>

Golf course search by state

<http://golfingnear.com>

Email search by domain

<http://emailbydomain.com>

Auto manuals search

<http://auto.somanuals.com>

TV manuals search

<http://tv.somanuals.com>