

KAWAI

Stage Piano
MP8

Owner's Manual

Important Safety Instructions

SAVE THESE INSTRUCTIONS

INSTRUCTIONS PERTAINING TO A RISK OF FIRE, ELECTRIC SHOCK, OR INJURY TO PERSONS

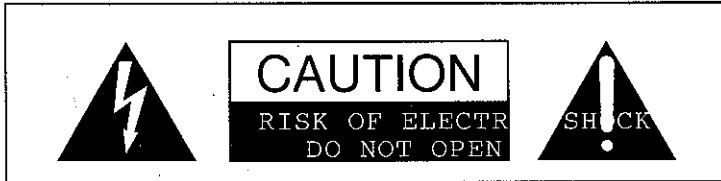

WARNING

TO REDUCE THE RISK OF FIRE OR ELECTRIC SHOCK, DO NOT EXPOSE THIS PRODUCT TO RAIN OR MOISTURE.

AVIS : RISQUE DE CHOC ELECTRIQUE - NE PAS OUVRIR.

TO REDUCE THE RISK OF ELECTRIC SHOCK, DO NOT REMOVE COVER (OR BACK). NO USER-SERVICEABLE PARTS INSIDE. REFER SERVICING TO QUALIFIED SERVICE PERSONNEL.



The lightning flash with arrowhead symbol, within an equilateral triangle, is intended to alert the user to the presence of uninsulated "dangerous voltage" within the product's enclosure that may be of sufficient magnitude to constitute a risk of electric shock to persons.



The exclamation point within an equilateral triangle is intended to alert the user to the presence of important operating and maintenance (servicing) instructions in the literature accompanying the product.

Examples of Picture Symbols



denotes that care should be taken. The example instructs the user to take care not to allow fingers to be trapped.



denotes a prohibited operation. The example instructs that disassembly of the product is prohibited.



denotes an operation that should be carried out. The example instructs the user to remove the power cord plug from the AC outlet.

Read all the instructions before using the product.

WARNING - When using electric products, basic precautions should always be followed, including the following.



WARNING Indicates a potential hazard that could result in death or serious injury if the product is handled incorrectly.

The product should be connected to an AC outlet of the specified voltage.



- If you are going to use an AC power cord, make sure that its has the correct plug shape and conforms to the specified power voltage.
- Failure to do so may result in fire.

Do not insert or disconnect the power cord plug with wet hands.



Doing so may cause electric shock.

When using the headphones, do not listen for long periods of time at high volume levels.



Doing so may result in hearing problems.

Do not disassemble, repair or modify the product.



Doing so may result in product breakdown, electric shock or short-circuit.

When disconnecting the AC power cord's plug, always hold the plug and pull it to remove it.

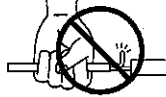

- Pulling the AC power cord itself may damage the cord, causing a fire, electric shock or short-circuit.

The product is not completely disconnected from the power supply even when the power switch is turned off. If the product will not be used for a long time, unplug the AC power cord from the AC outlet.



- Failure to do so may cause fire in case of lightning.
- Failure to do so may over-heat the product, resulting in fire.



CAUTION

Indicates a potential hazard that could result in injury or damage to the product or other

Do not use the product in the following areas.

- Areas, such as those near windows, where the product is exposed to direct sunlight
- Extremely hot areas, such as near a heater
- Extremely cold areas, such as outside
- Extremely humid areas
- Areas where a large amount of sand or dust is present
- Areas where the product is exposed to excessive vibrations

Using the product in such areas may result in product breakdown. Use the product only in moderate climates (not in tropical climates).

Before connecting cords, make sure that the power to this product and other devices is turned OFF.



Failure to do so may cause breakdown of this product and other devices.

Take care not to allow any foreign matter to enter the product.

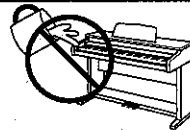

Entry of water, needles or hair pins may result in breakdown or short-circuit. The product shall not be exposed to dripping or splashing. No objects filled with liquids, such as vases, shall be placed on the product.

Do not drag the product on the floor. Take care not to drop the product.

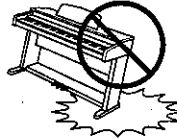

Please lift up the product when moving it. Please note that the product is heavy and must be carried by more than two persons. Dropping the product may result in breakdown.

Do not place the product near electrical appliances such as TVs and radios.

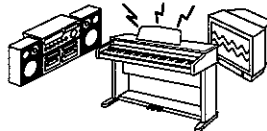

- Doing so may cause the product to generate noise.
- If the product generates noise, move the product sufficiently away from the electrical appliance or connect it to another AC outlet.

When connecting the AC power cord and other cords, take care not to get them tangled.

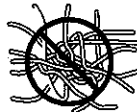

Failure to do so may damage them, resulting in fire, electric shock or short-circuit.

Do not wipe the product with benzene or thinner.



- Doing so may result in discoloration or deformation of the product.
- When cleaning the product, put a soft cloth in lukewarm water, squeeze it well, then wipe the product.

Do not stand on the product or exert excessive force.



- Doing so may cause the product to become deformed or fall over, resulting in breakdown or injury.

The product should be located so that its location or position does not interfere with its proper ventilation. Ensure a minimum distance of 5cm around the product for sufficient ventilation. Ensure that the ventilation is not impeded by covering the ventilation openings with items, such as newspaper, table-cloths, curtains, etc.

Do not place naked flame sources, such as lighted candles on the product.

The product should be serviced by qualified service personnel when:

- The power supply cord or the plug has been damaged.
- Objects have fallen, or liquid has been spilled into the product.
- The product has been exposed to rain.
- The product does not appear to operate normally or exhibits a marked change in performance.
- The product has been dropped, or the enclosure damaged.

Notes on Repair

Should an abnormality occur in the product, immediately turn the power OFF, disconnect the power cord plug, and then contact the shop from which the product was purchased.

GROUNDING INSTRUCTIONS

This product must be grounded. If it should malfunction or breakdown, grounding provides a path of least resistance for electric current to reduce the risk of electric shock. This product is equipped with a cord having an equipment-grounding conductor and a grounding plug. The plug must be plugged into an appropriate outlet that is properly installed and grounded in accordance with all local codes and ordinances.

DANGER - Improper connection of the equipment-grounding conductor can result in a risk of electric shock. Check with a qualified electrician or serviceman if you are in doubt as to whether the product is properly grounded. Do not modify the plug provided with the product - if it will not fit the outlet, have a proper outlet installed by a qualified electrician.

Declaration of Conformity according to FCC Part 15

Responsible Party: Kawai America Corporation
Address: 2055 East University Drive, Rancho Dominguez, CA 90220
Telephone: (310) 631-1771
declares that the product: Stage Piano MP8
complies with Part 15 of the FCC Rules.

This device complies with Part 15 of the FCC Rules. Operation is subject to the following two conditions: (1) this device may not cause harmful interference, and (2) this device must accept any interference received, including interference that may cause undesired operation.

NOTE: This equipment has been tested and found to comply with the limits for a Class B digital device, pursuant to Part 15 of the FCC Rules. These limits are designed to provide reasonable protection against harmful interference in a residential installation. This equipment generates, uses and can radiate radio frequency energy and, if not installed and used in accordance with the instructions, may cause harmful interference to radio communications.

If this equipment does cause harmful interference to radio or television reception, which can be determined by turning the equipment off and on, the user is encouraged to try to correct the interference by one or more of the following measures:

- Reorient or relocate the receiving antenna.
- Increase the separation between the equipment and receiver.
- Connect the equipment into an outlet on a different electrical circuit from the receiver.
- Consult the dealer or an experienced radio/TV technician for help.

FCC WARNING: Changes or modifications not expressly approved by the party responsible for compliance could void the user's authority to operate the equipment.

Canadian Radio Interference Regulations

This instrument complies with the limits for a class B digital apparatus, pursuant to the Radio Interference Regulations, C.R.C., c. 1374.

WELCOME TO THE MP8

Thank you for purchasing the KAWAI MP8. The MP8 Stage Piano features 256 Internal Sounds of the highest quality. The MP8 can also be used as a MIDI master controller. On stage, at home, or in the studio, the MP8 has been designed to offer quick and easy access to many sophisticated features.

BASIC FEATURES of the MP8

4 ASSIGNABLE ZONES

The MP8 keyboard can be divided into 4 zones. Each zone can be set to INT, EXT or BOTH individually. INT (Internal) is to play any of the 256 internal sounds. EXT (External) is to play external MIDI devices. BOTH is to play internal sounds and external MIDI devices at the same time. Each zone can be played individually, or multiple zones can be freely split, layered and velocity switched to create stunning and personalized performances.

ACOUSTIC TOUCH KEYBOARD

The MP8's "AWA Grand Pro" wooden keyboard provides excellent feel and control like that found in an acoustic piano.

256 INTERNAL SOUNDS, 256 SETUPS

The MP8 offers not only acoustic piano and electric piano sounds, but also other sounds such as organ, brass, pads and so on. All the settings of these sounds, together with the settings to control the external devices, can be stored into 256 setups.

REVERB AND EFFECTS

The MP8 offers 7 high quality REVERB types, and 20 different EFFECT types to improve acoustical realism and enhance tonal quality.

CONTROL KNOBS

The MP8 has 4 multi-function CONTROL KNOBS, which offer real time control of the EFFECTS, EQ, TONE MODIFY and MIDI-CONTROL CHANGE messages.

TABLE OF CONTENTS

WELCOME TO THE MP8.....5	6.2.8 Prg # (Ext only).....32
1. NAMES AND FUNCTIONS.....8	6.2.9 TX Bank (Ext only).....33
1.1 FRONT PANEL.....8	6.2.10 Bank MSB/LSB (Ext only).....33
1.2 HEADPHONE JACK.....10	6.2.11 Key Range Hi/Lo33
1.3 REAR PANEL.....10	6.2.12 Velocity Switch.....34
2. Basic Operations.....12	6.2.13 Velocity Switch Value.....34
2.1 Getting Ready.....12	6.2.14 Velocity Compression.....34
2.2 Selecting a Sound.....12	6.2.15 Velocity Offset.....35
2.3 Layer.....14	6.2.16 Zone Transpose.....35
2.4 Split.....14	6.2.17 Transmitting Volume (Ext only).....35
2.5 Piano Only.....15	6.2.18 Volume.....35
2.6 Metronome.....15	6.2.19 Transmitting Control Change.....35
2.7 Transpose.....15	6.2.20 Pan.....35
2.8 Using the MP8 as a MIDI controller.....16	6.2.21 Fine Tune.....36
2.9 Selecting a SETUP.....17	6.2.22 Damper.....36
3. SW Button.....18	6.2.23 Foot Switch.....36
3.1 Panel Lock.....18	6.2.24 Expression Pedal.....36
3.2 Touch Curve.....18	6.2.25 Modulation.....36
3.3 Rotary Slow/Fast.....19	6.2.26 Bender.....36
3.4 EQ Bypass On/Of.....19	6.2.27 Transmitting Bender Range (Ext only).....36
3.5 Wheel Lock.....18	6.2.28 Bender Range.....37
3.6 Foot Switch Lock.....20	6.2.29 Solo.....37
3.7 Expression Pedal Lock.....20	6.2.30 Solo Mode.....37
3.8 External Sequencer Start/Stop.....21	6.3 Common Parameters.....37
4. EFX/REVERB.....22	6.3.1 Stretch Tuning.....37
4.1 EFX.....22	6.3.2 Temperament.....38
4.2 REVERB.....23	6.3.3 Key of Temperament.....38
5. Control Knobs.....24	6.3.4 Tuning C-B.....38
5.1 EFFECT.....24	6.3.5 FSW Control Change Number.....39
5.2 EQ (EQUALIZER).....25	6.3.6 EXP Control Change Number.....39
5.3 TONE MODIFY.....25	6.3.7 Master Volume.....39
5.4 MIDI CC# (Control Change).....26	7. STORE.....40
6. MENU.....30	7.1 Storing the settings as a SETUP....40
6.1 Editing Procedure and Parameters.....31	8. SYSTEM.....41
6.2 Edit Parameters.....31	8.1 System Menu.....41
6.2.1 Zone Mode.....31	8.2 System Parameters.....41
6.2.2 Sound (Int only).....31	8.2.1 System Channel.....42
6.2.3 Voicing (Int Piano only).....31	8.2.2 Initial SW42
6.2.4 Damper Effect (Int Piano only).....32	8.2.3 Touch42
6.2.5 String resonance (Int Piano only).....32	8.2.4 System Tuning.....43
6.2.6 TX Ch (Ext only).....32	8.2.5 Volume Slider Action.....43
6.2.7 TX Prg # (Ext only).....32	8.2.6 Local Control.....43
	8.2.7 Multi-Timbral Mode.....44
	8.2.8 Receive Channel.....44
	8.2.9 LCD Contrast.....44
	8.2.10 LED Brightness.....44
	8.2.11 Out Mode.....44
	8.2.12 Foot Switch Mode45
	8.3 System Dump.....45
	8.3.1 Dump Current.....45
	8.3.2 Dump All.....45

8.4 System Rest.....	46
8.4.1 Reset One SETUP.....	46
8.4.2 Reset All.....	46
8.5 System EFX/REVERB.....	46
8.5.1 Save EFX/REVERB.....	46
8.5.2 Reset EFX/REVERB.....	47
9. OTHER.....	48
9.1 MIDI IN.....	48
9.2 SETUP Program Number Table.....	48
9.3 SOUND Program Number List.....	49
9.4 Notes about USB.....	55
Specifications.....	56
MP4 MIDI Implementation.....	58
1. Recognized Data.....	59
1.1 Channel Voice Message.....	59
1.2 Channel Mode Message.....	61
1.3 System Realtime Message.....	62
2. Transmitted Data.....	62
2.1 Channel Voice Message.....	62
2.2 Channel Mode Message.....	64
2.3 System Realtime Message.....	65
3. Exclusive Data.....	65
3.1 Universal Realtime Exclusive Message.....	65
3.2 MP4 Dump Message.....	65
3.3 Setup Data Format.....	65
4. Control Change Number (CC#) Table.....	68
MIDI Implementation Chart	

1. NAMES AND FUNCTIONS

1.1 FRONT PANEL

[FADER SECTION]

1. VOLUME Fader

The VOLUME fader controls the master volume level of the MP8.

2. ZONE SELECT buttons

The ZONE SELECT buttons are used to select one of the four zones for editing. Only one zone can be selected at a time. The front panel setting represents the current zone status.

3. ON/OFF buttons

The ON/OFF buttons are used to turn zones ON/OFF. When the button is lit, the zone is active. Normally the button color is red, but when a zone is not using the full keyboard range the color will be green to indicate it.

4. FADERS (zone volume level control)

Each fader controls the volume level of a designated zone. When multiple zones are active, these faders can be used as an audio mixer.

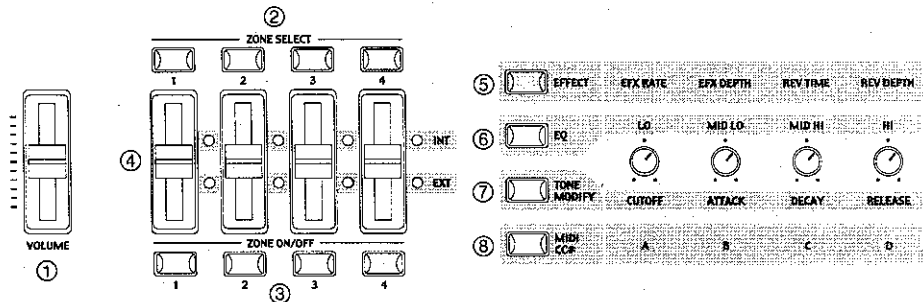

[CONTROL KNOBS SECTION]

The four CONTROL KNOBS are multi-function real time controllers. The different functions can be selected using the four buttons to the left side of the CONTROL KNOBS. When a function is active, its button is lit. Touching any of these knobs will instantly change the display to the current knob function and value.

5. EFFECT button

When this button is lit, the CONTROL KNOBS will adjust the REVERB time, REVERB depth, EFX rate and EFX depth.

6. EQ button

When this button is lit, the CONTROL KNOBS will adjust the 4-band graphic equalizer.

7. TONE MODIFY button

When this button is lit, the CONTROL KNOBS will adjust the CUTOFF, ATTACK, DECAY and RELEASE Levels for the selected zone.

8. MIDI CC# button

When this button is lit, MIDI control changes are sent from the MP4 to the MIDI device specified by the selected zone. Some control changes can also be used with the internal sounds.

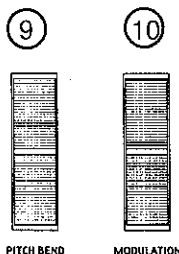

[WHEEL CONTROLLERS]

9. PITCH BEND

This control wheel smoothly bends the pitch Up or Down from its current value.

10. MODULATION

This control wheel controls the modulation (vibrato) depth. Moving the wheel forward increases the vibrato depth.

[EFFECT BUTTONS]

11. SW button

This button turns the assigned function ON or OFF. Many different functions can be assigned to this switch for your convenience.

12. EFX button

This button turns the EFX ON or OFF for the selected zone.

13. REVERB button

This button turns the REVERB ON or OFF for the selected zone.

To change the function or type assigned to the above buttons, press and hold the desired button to display the currently selected function or type, then use the VALUE buttons to change it.

[MENU BUTTONS]

14. MENU buttons

The MENU buttons are used to enter the edit mode and scroll through all the various parameters of the MP8. To change a parameter value, use the VALUE buttons. Pressing both MENU buttons simultaneously will exit from the edit mode.

[DISPLAY]

15. DISPLAY

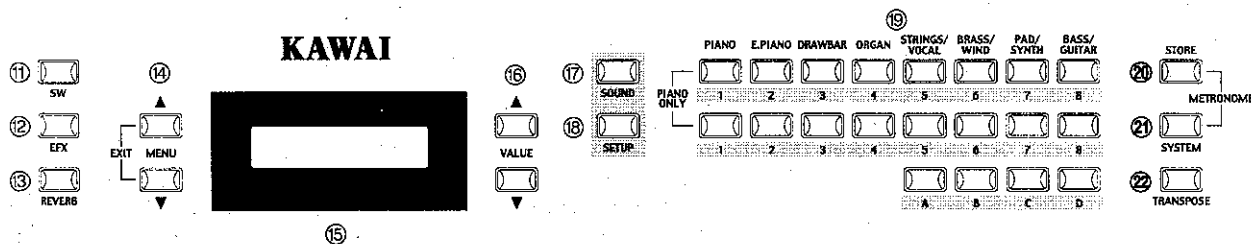

[VALUE BUTTONS]

16. VALUE buttons

The VALUE buttons are used to change the value of the current parameter as indicated on the DISPLAY.

[SOUND SELECTION & SETUP SELECTION]

17. SOUND button

The SOUND button switches the MP8 to the SOUND mode. The PATCH buttons will now select any of the 256 internal sounds.

18. SETUP button

The SETUP button switches the MP8 to the SETUP mode. The PATCH buttons will now select any of the 256 SETUPS.

19. SOUND SELECT buttons

The SOUND SELECT buttons are organized in two rows of eight buttons and one row of four ones. In SOUND mode the upper row of buttons is used to select a sound category and the second & third rows of buttons is used to select the different internal sounds within each category. In SETUP mode the upper row of buttons is used to select a bank and the second & third rows of buttons is used to select the different SETUPS within each bank.

[OTHERS]

20. STORE button

The STORE button is used to store the settings of the MP8.

21. SYSTEM button

The SYSTEM button is used to set the system parameters of the MP8.

22. TRANSPOSE button

The TRANSPOSE button is used to turn the TRANSPOSE function ON/OFF.

1.2 HEADPHONE JACK

The headphone jack is located in front at the left end of the key slip. Use a headphone with a standard stereo 1/4 inch phone jack.

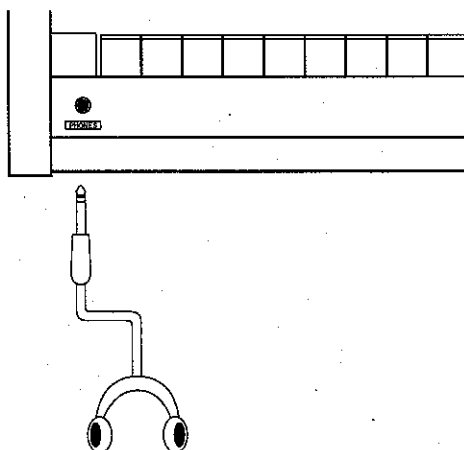

1.3 REAR PANEL

1. OUTPUTS -FIXED- R, L OUTPUTS

The R, L outputs are used to connect the MP8 to a musical instrument amplifier using XLR Terminals. The R, L outputs can also be used to connect the MP8 to a PA system or recording console. The (Master) VOLUME fader and the EQ settings DO affect these outputs.

GROUNDLIFT SW

With this switch ON, a possible ground loop can be shut from an external machine which is connected to your MP8 with XLR terminal. Usually you may leave the switch to its OFF position.

2. OUTPUTS -Normal- R, L/MONO OUTPUTS

The R, L/MONO outputs are used to connect the MP8 to a musical instrument amplifier using standard 1/4 inch phone jacks. The R, L/MONO outputs can also be used to connect the MP8 to a PA system or recording console. The EQ settings DO affect these outputs.

3. FOOT CONTROLLERS

EXP JACK

An expression pedal can be connected to this jack.

The expression pedal can be assigned to different MIDI control numbers or functions in the Menu.

FSW JACK

A momentary footswitch can be connected to this jack. (EX: Kawai F-1) The FootSwitch can be assigned to different MIDI control numbers or functions in the Menu.

4. DAMPER / SOFT JACK

This jack is used to connect the Foot Pedal included with the MP8. (Kawai F-20)

The right pedal works as Damper pedal, and the left one works as Soft pedal. When the Rotary EFX is in use, the Soft pedal changes function to a Fast/Slow Rotor switch.

5. MIDI JACKS

These jacks are used to connect the MP8 with external MIDI devices such as a MIDI sound module or a MIDI sequencer

6. USB JACK

This jack is used to connect the MP8 with a personal computer See page 55 for details.

7. POWER SWITCH

Turns the MP8 ON or OFF.

8. POWER RECEPTACLE

Connect the power cable, which is included in the MP8 package, to this receptacle.

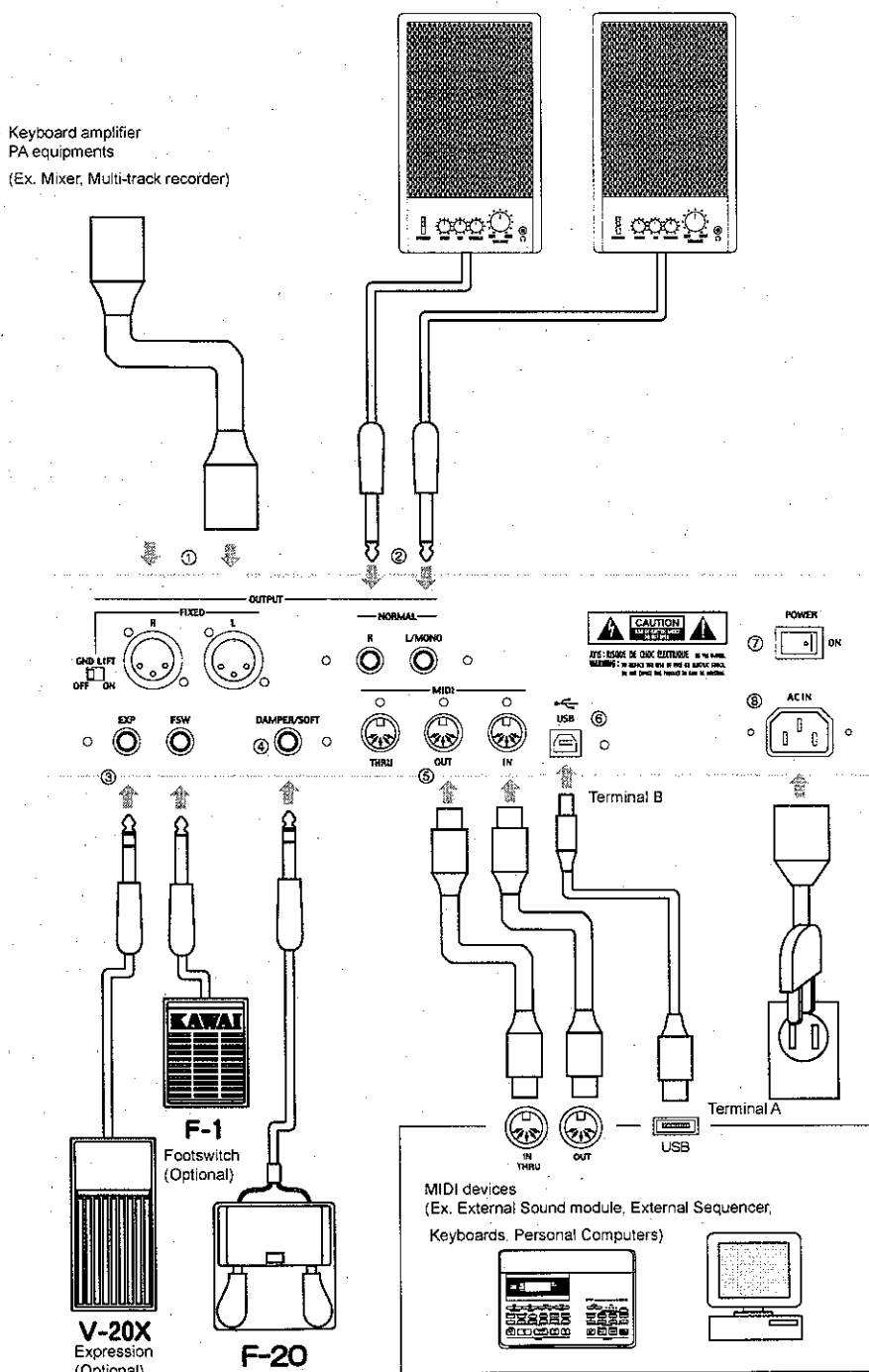

2. Basic Operations

2.1 Getting Ready

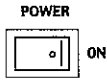

Since the MP8 has no built-in speakers, you will need to connect a mixer, keyboard amplifier or headphones in order to listen.

Turn the MP8 on, using the POWER SWITCH on the rear panel. It is recommended to turn the MP8 on before turning on any amplifiers in order to avoid switching noise.

What you need to know before starting:

Please read this part for a better understanding of the MP8 structure.

Basically there is no difference between SOUND and SETUP mode. The main difference is that SETUP is used to recall your stored SETUPS. You can edit and make changes in both modes freely. The same parameters are available in both modes.

If you edit in SOUND mode, your settings get lost, after power off, if you don't store them as SETUP!

If you want to start from scratch use the SOUND mode and press PIANO ONLY first.

If you want to modify a SETUP just select it and start editing and store later it as SETUP.

If you notice when you select a sound that it sounds strange it's probably because some of the parameters like knobs etc. were edited. To get back to the default settings for any sound simply use the PIANO ONLY function and reselect the sound.

2.2 Selecting a Sound

The MP8 always starts up in SOUND mode when the power is turned ON. The SOUND button will be lit to indicate SOUND mode is active.

Operation 1

Select the sound category by pressing a sound select button in the top row. There are 3 rows of sound select buttons, the top row is for selecting a sound category and the second and third rows are for selecting a variation.

For example, to select "60's EP2", first press the E.PIANO in the top row and the first sound in the E.PIANO category "Classic EP" is recalled. (If any other variation was selected before, the last selected sound is recalled as long as the power is on.)

Operation 2

Select the first variation by pressing a sound select button in the second row. Press one of the 1-8 buttons in the second row. If you press 3, the variation 3 "60's EP" is recalled. (If any other variation was selected before, the last selected sound is recalled as long as the power is on.)

Operation 3

Select the second variation by pressing a sound select button in the third row.

Press one of the A-D buttons in the second row. If you press B, a variation sound "60's EP2" is recalled.

Select the variations with the sound select buttons in the second and third rows.

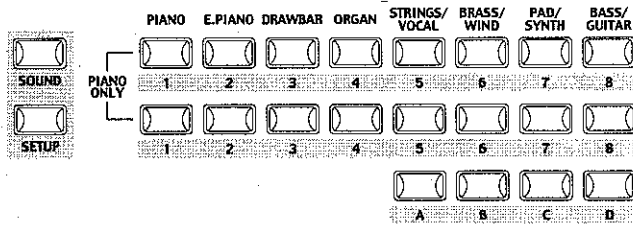

The display shows the currently selected sound name.

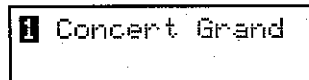

Note:

Internal sounds or Setups can be also selected using the VALUE buttons.

You should also listen to the preprogrammed Setups.

Setups are organized in 8 Banks with 32 Numbers each (total 256 Setups). Press the SETUP button to change to SETUP mode and select a Setup by pressing one of the Bank buttons in the upper row followed by a Number button in the second and third row.

The display shows the currently selected Setup name.

In Sound mode, the "1" in the display indicates that the zone 1 is currently selected.

When the multitimbre is off, the default settings of the zones are as follows. It is recommended for simple MIDI transmit/receive use on stage etc.

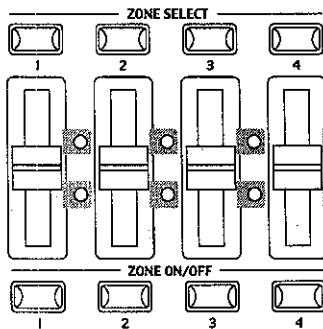

- Zone 1 Internal On (Plays internal sound)
- Zone 2 Internal Off (Muted)
- Zone 3 External On (Plays external device) The default TX channel is 1.
- Zone 4 External Off (Muted)

When the multitimbre is on, the default settings of the zones are as follows. It is recommended for recording/playback with PC or sequencer

- Zone 1 Both On (Plays internal sound & external device)
The default TX channel is 1
- Zone 2 Both Off (Muted)
- Zone 3 Both Off (Muted)
- Zone 4 Both Off (Muted)

The zone mode for each zone is indicated by the INT/EXT LED beside the faders. The zone status for each zone is indicated by the ZONE ON/OFF buttons. If the ZONE buttons is red, this zone is assigned to the entire keyrange of the MP8. If the button is green, the key range for that zone is less than the entire key range. You can check the key range setting by holding the SELECT button for the zone for 1 second.

2.3 Layer

Let's try layering another sound. Turn the zone 2 on by pressing the ZONE ON/OFF button for zone 2. The ZONE SELECT button for zone 2 is automatically selected and the display shows the sound name for zone 2.

Select the sound for zone 2 with the SOUND SELECT buttons as shown in the previous section.

```
String Pad
```

Adjust the volume balance of zone 1 and 2 with the faders for each zone.

2.4 Split

Now let's split the keyboard and play different sounds in upper and lower sections.

Press and hold the ZONE SELECT button for zone 1. The display shows the key range for zone 1 as follows.

```
Key C-2 > G8  
Range C-2 > G8
```

While still holding down the ZONE SELECT button for zone 1, press the lowest note on the keyboard. The display changes as follows.

```
KeyRange(Both)  
= A-1 > ----
```

While still holding down the ZONE SELECT button for zone 1, select the highest note for zone 1, for example, B2 by pressing B2 key on the keyboard.

```
KeyRange(Both)  
= A-1 > B2
```

Repeat the same procedure for zone 2 while holding down the ZONE SELECT button for zone 2 and set the key range from C3 to C7.

```
KeyRange(Both)  
= C3 > C7
```

Now the keyboard is split as follows.

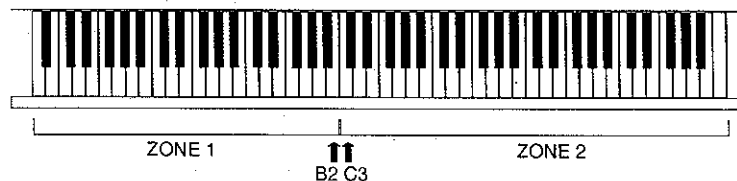

Note:

In this method, the key ranges for internal and external zones always change together. If you want individual settings, use the Key Range Hi/Lo parameter in MENU (see page 31).

2.5 Piano Only

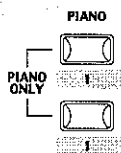

The Piano Only function lets you quickly return the MP8 sounds to the default settings.

Press the PIANO button and the SOUND SELECT button 1 simultaneously. All the current settings (except for SYSTEM settings) will go back to original and only Concert Grand sound can be played on the whole keyboard.

Note:

You may use this function also as a kind of Panic or Reset button. Also it is a good starting point to create Setups from scratch.

2.6 Metronome

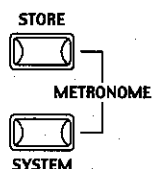

A metronome is available on the MP8.

Press the STORE and SYSTEM buttons simultaneously to start the metronome.

Press the STORE or SYSTEM button to stop the metronome.

Changing the Tempo/Volume

The display will show as follows.



Use the VALUE buttons to change the tempo.

Use the MENU buttons to change the volume.

Note:

The metronome tempo is also used as MIDI dock tempo to control an external sequencer. See page 20 for details.

2.7 Transpose



When the Transpose function is "ON" the MP8's key can be raised or lowered in half steps. The available range of transposition is 24 semitones, either up or down.

While holding down the TRANSPOSE button, press any key on the MP8 keyboard to select a new transposed key. Pressing the F key above middle C for example will transpose the MP8 UP to the key of F (+5 half steps).

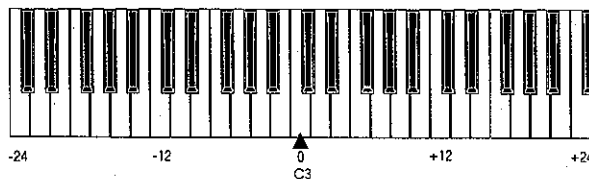

The transpose amount can also be set using the VALUE buttons. While holding the TRANSPOSE button down, press the VALUE buttons to change the transpose amount. The display shows the current TRANSPOSE amount when the TRANSPOSE button is held down. A value of "0" indicates no transposition.

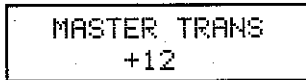

```
MASTER TRANS
+12
```

2.8 Using the MP8 as a MIDI controller

The MP8 can control external devices via MIDI.

MIDI Connection

Connect the MIDI OUT on the MP8 to the MIDI IN on an external MIDI device with a MIDI cable.

Selecting the MIDI Channel

The MIDI Transmit Channel of the MP8 must be matched with the Receive Channel of any MIDI devices connected to the MP8.

Select zone 3 by pressing the ZONE SELECT button 3. (Zone 3 is set to external as default setting.)

Press the MENU-UP button until "TX Channel" (Transmit Channel) appears on the display.

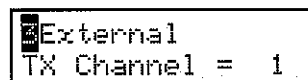

```
External
TX Channel = 1
```

Use the VALUE buttons to choose a MIDI Transmit Channel from 1 to 16.

To exit from MENU, press both MENU UP and DOWN buttons simultaneously.

Any notes played on the keyboard or any movements of the Knobs, sliders, etc. will be transmitted to any external MIDI devices connected to the MIDI out of the MP8 on the selected MIDI channel.

Sending Program Change Number

The MP8 can send MIDI program change numbers from 1 to 256 and Bank number LSB from 0 to 1 in SOUND mode. Simply press the SOUND SELECT buttons and the corresponding program number will be transmitted. See the program number table below.

UPPER	SECOND	THIRD	PROG#:MSB-LSB
1	1	A	001:000-000
1	1	B	002:000-000
1	1	C	003:000-000
1	1	D	004:000-000
1	2	A~D	005:000-000 ~ 008:000-000
1	3	A~D	009:000-000 ~ 012:000-000
1	4	A~D	013:000-000 ~ 016:000-000
1	5	A~D	017:000-000 ~ 020:000-000
1	6	A~D	021:000-000 ~ 024:000-000
1	7	A~D	025:000-000 ~ 028:000-000
1	8	A~D	029:000-000 ~ 032:000-000
2	1~8	A~D	033:000-000 ~ 064:000-000
3	1~8	A~D	065:000-000 ~ 096:000-000
4	1~8	A~D	097:000-000 ~ 128:000-000
5	1~8	A~D	001:000-001 ~ 032:000-001
6	1~8	A~D	033:000-001 ~ 064:000-001
7	1~8	A~D	065:000-001 ~ 096:000-001
8	1~8	A~D	097:000-001 ~ 128:000-001

The transmitted program number is shown in the display.

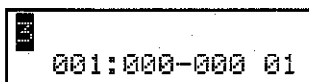

You can also send program change numbers by using VALUE buttons.

Note:

Full program change numbers including bank numbers can be transmitted by setting them in MENU and saving it as a SETUP. See page 31 for details.

2.9 Selecting a SETUP

The MP8 offers 256 preset combinations of the panel settings called SETUPS. To select a SETUP, press the SETUP button. Now the SOUND SELECT buttons are used to select a SETUP. Use a combination of the numbers in the upper, second and third rows to select a desired SETUP. The display will show the selected SETUP name.

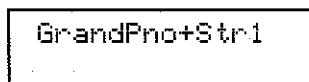

To check the sound (internal) or program number (external) assigned to each zone, press the ZONE SELECT button. The display briefly shows the assigned sound name or program number, and then automatically returns to the SETUP name in a few seconds.

If you hold a ZONE SELECT button for 2 seconds the display will show you the key range information for that zone. You can also set the key range using the same procedure that is used in Sound mode.

3. SW Button



The SW button is a programmable realtime switch which can be assigned to one of 8 different functions.

Press and hold the SW button. The display shows the currently assigned function. Press the SW button again to exit without changing the function.

```
SW TYPE
1: Panel Lock
```

Use the VALUE buttons to change the function. The display will automatically return to SOUND or SETUP mode after you change the function.

3.1 Panel Lock

You can lock the panel operation to avoid unnecessary changes to the settings by accident.

When the SW button is lit Panel Lock is ON.

Panel Lock On: All the operations except for keyboard, wheels, pedals and SW button are locked. The display shows as follows while the panel is locked.

```
Panel Lock
>Press[SW]button
```

Panel Lock Off: Panel Lock is canceled.

3.2 Touch Curve

You can temporary turn on/off the Touch Curve for example to play organ sounds correctly.

When the SW button is lit the Touch Curve is ON.

Touch Curve On: The display briefly shows the selected Touch Curve in the SYSTEM and the Touch Curve becomes active. If the selected Touch Curve in the SYSTEM is Off, the Normal Touch Curve becomes active.

Touch Curve Off: The display briefly shows as follows and the Touch Curve becomes Off.

```
Touch Curve
Off
```

3.3 Rotary Slow/Fast

You can switch the speed of roter between slow and fast when the Rotary effect is in use.

When the SW button is lit: The display briefly shows as follows and the rotary speed changes to fast.

```
Rotary Speed  
Fast
```

When the SW button is OFF: The display briefly shows as follows and the rotary speed changes to slow.

```
Rotary Speed  
Slow
```

Note:

When the Rotary effect is not in use, the display briefly shows as follows.

```
Rotary is  
not selected.
```

3.4 EQ Bypass On/Off

You can temporarily bypass the EQ by turning the SW button on.

When the SW button is lit the EQ Bypass is on.

EQ Bypass On: The display briefly shows as follows and the sound bypasses the EQ.

```
EQ Bypass  
On
```

EQ Bypass Off: The display briefly shows as follows and the EQ comes back to active.

```
EQ Bypass  
Off
```

Note:

When the EQ Bypass is turned on and the EQ control knobs are used, the display briefly shows as follows.

```
EQ Bypass  
>Press [SW] button
```

3.5 Wheel Lock

You can lock the bender wheel and modulation wheel to avoid unnecessary movement by accident.

When the SW button is lit the Wheel Lock is on.

Wheel Lock On: The display briefly shows as follows and the wheels are locked.

```
Wheel Lock  
On
```

Wheel Lock Off: The display briefly shows as follows and the wheels are unlocked.

```
Wheel Lock  
Off
```

Note:

When the Wheel Lock is turned on and the wheels are used, the display briefly shows as follows.

```
Wheel Lock  
>Press[SW]button
```

3.6 Foot Switch Lock

You can lock the assignable foot switch to avoid unnecessary movement by accident.

First, connect a foot switch to the FSW jack on the rear panel of the MP8.

When the SW button is lit the Foot Switch Lock is on.

Foot Switch Lock On: The display briefly shows as follows and the assignable foot switch is locked.

```
FSW Lock  
On
```

Foot Switch Lock Off: The display briefly shows as follows and the assignable foot switch is unlocked.

```
FSW Lock  
Off
```

Note:

When the FSW Lock is turned on and the foot switch is used, the display briefly shows as follows.

```
FSW Lock  
>Press[SW]button
```

3.7 Expression Pedal Lock

You can lock the expression pedal to avoid unnecessary movement by accident.

First, connect an expression pedal to the EXP jack on the rear panel of the MP8.

When the SW button is lit the Expression Pedal Lock is on

Expression Pedal Lock On: The display briefly shows as follows and the expression pedal is locked.

```
EXP Lock
  On
```

Expression Pedal Lock Off: The display briefly shows as follows and the expression pedal is unlocked.

```
EXP Lock
  Off
```

Note:

When the EXP Lock is turned on and the expression pedal is used, the display briefly shows as follows.

```
EXP Lock
>Press[SW]button
```

3.8 External Sequencer Start/Stop

You can start and stop the external sequencer connected to the MP8 with SW button.

First, connect an external sequencer to the MIDI OUT jack on the rear panel of the MP8. Make sure that the sequencer is capable to receive external MIDI clock and commands. Check the MIDI implementation chart of the sequencer if the Recognized column of the System Real Time Clock & Commands is marked "O (yes)". Consult the owner's manual of the sequencer how to set the sequencer to receive external MIDI clock and commands.

When the SW button is lit the MIDI clock is transmitted

External Sequencer Start: Press the SW button to turn the light on. The display briefly shows as follows and the external sequencer starts.

```
External Seq
  Start
```

External Sequencer Stop: Press the SW button to turn the light off. The display briefly shows as follows and the external sequencer stops.

```
External Seq
  Stop
```

Note:

The tempo is controlled by the Metronome tempo of the MP8. See page 14 for details.

4. EFX/REVERB



EFX



REVERB

The internal sounds of the MP8 can be enhanced using the built in REVERB and EFX generators.

There are 7 REVERB types and 20 different EFX types to choose from. MP8 contains 4 variations of EFX type per INT section, and different EFX can be added to the sound of each ZONE.

4.1 EFX

The MP8 contains 20 high quality EFX types, designed to complement the internal sounds. Each internal sound has a preset effect assigned as the default. The EFX button turns the EFX generator ON or OFF for the selected sound.

To turn the EFX "ON" for the current sound, press the EFX button and the button will light up. EFX will be added to the current sound.

To turn the EFX "OFF" again, press the EFX button again (The light on the button will be turned OFF).

EFX type

Press and hold the EFX button for a few seconds. The display shows EFX type added to the current selected ZONE.

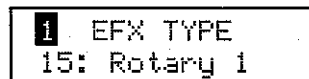

Use the VALUE buttons to change the effect type. Each EFX type has a default value for RATE and DEPTH, so when changing the EFX type, the values are changed automatically. You can edit these values with the EFX RATE and EFX DEPTH knobs in the first row of the CONTROLKNOBS section on the panel. To choose another ZONE, press ZONE SELECT button of it.

- Chorus: Chorus is a slight detuning of the sound, which adds depth and richness to the sound.
- Flanger: Flanger introduces a shifting comb-filter, which adds motion and a "hollow" tone to the sound.
- Celeste: Celeste is a three phase chorus, with each of the three chorus units at different phase.
- Ensemble: Ensemble is a three phase chorus, with each of the three chorus units at a different phase and frequency. This gives a slightly richer sound than the Celeste effect, above.
- Delay 1/2/3/4: Delay adds echoes to the sound.
- AutoPan 1/2: AutoPan alternates the sound left and right across the stereo field at a variable rate.
- Tremolo 1/2: Tremolo changes the volume of the sound, making it louder and softer at a variable rate.
- Phaser 1/2: Phaser creates a cyclic phase change, adding motion to the sound.
- Rotary 1/2: The Rotary effect simulates the sound of the rotary speaker

cabinet commonly used with electronic organs. Rotary 2 include an overdrive effect.

- Auto Wah: Auto Wah creates an automatic filter sweep at the attack of each note.
- Pedal Wah: Pedal Wah creates a filter sweep with the expression pedal connected to the MP8.
- Enhancer: Enhancer produces a crisper tone, so the sound is more easily discernible.
- Overdrive: Overdrive effect adds tube-amp style distortion.

Note:

EFX type is common to all internal zones. You can not select different types for each zone. But you can individually turn on/off the EFX for each zone.

4.2 REVERB

The MP8 contains 7 high quality REVERB types, designed to complement the internal sounds. Each internal sound has a preset REVERB type assigned as the default. The REVERB button turns the REVERB generator ON or OFF for the selected sound.

To turn the REVERB "ON" for the current sound, press the REVERB button and the button will light up.

REVERB will be added to the current sound.

To turn the REVERB "OFF" again, press the REVERB button again (The light on the button will be turned OFF).

REVERB type

Press and hold the REVERB button until the display shows REVERB type.

```
REVERB TYPE
1: Hall 1
```

Use the VALUE buttons to change the REVERB type. Each REVERB type has a default value for TIME, so when changing the REVERB type, the value is changed automatically.

- Hall 1: Simulates the reverb in a standard hall
- Hall 2: Simulates the reverb in a small hall
- Stage 1: Simulates the reverb on a standard stage
- Stage 2: Simulates the reverb on a small stage
- Room 1: Simulates the reverb in a standard room
- Room 2: Simulates the reverb in a small room
- Plate: Simulates the reverb of a metallic plate

Note:

REVERB type is common to all internal zones. You can not select different type for each zone. But you can individually turn on/off or set different depth for each zone.

5. Control Knobs

Select the function with the buttons on the left and use the knobs to change the values. You can also move the cursor with the MENU buttons and change the value with the VALUE buttons while the display is showing Control Knobs function.

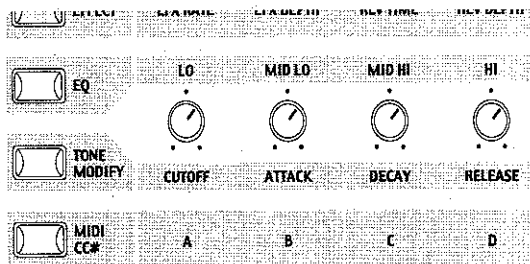

5.1 EFFECT

Make sure that the EFFECT button in the CONTROL KNOBS section is lit. If the EFFECT button is turned off, press it to turn it ON.

The CONTROL KNOBS are now active and assigned to the EFX/REVERB parameters for the selected zone. Use the CONTROL KNOBS to change the current settings.

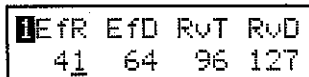

EfR (EFX Rate) adjusts the value of the preset parameter for each EFX. (internal only)

EfD (EFX Depth) adjusts the depth of the EFX added to the sound.

RvT (REVERB Time) adjusts the reverb time. (internal only)

RvD (REVERB Depth) adjusts the depth of the reverb added to the sound.

EFX parameter list

	<u>EFX Rate</u>	<u>EFX Depth</u>
1. CHORUS	rate 0 -12.7Hz	send level
2. FLANGER	rate 0 -12.7Hz	send level
3. CELESTE	rate 0 -12.7Hz	send level
4. ENSEMBLE	rate 0 -12.7Hz	send level
5. DELAY 1	delay time 0 -100 (%)	send level
6. DELAY 2	delay time 0 -100 (%)	send level
7. DELAY 3	delay time 0 -100 (%)	send level
8. DELAY 4	delay time 0 -100 (%)	send level
9. AUTO PAN 1	rate 0 -12.7Hz	wet balance
10. AUTO PAN 2	rate 0 -12.7Hz	wet balance
11. TREMOLO 1	rate 0 -12.7Hz	wet balance
12. TREMOLO 2	rate 0 -12.7Hz	wet balance
13. PHASER 1	rate 0 -12.7Hz	wet balance
14. PHASER 2	rate 0 -12.7Hz	wet balance
15. ROTARY 1	rate slow/fast	wet balance
16. ROTARY 2	rate slow/fast	wet balance

17. AUTO WAH	sense	0 -100 (%)	wet balance
18. PEDAL WAH	sense	0 -100 (%)	wet balance
19. ENHANCER	intensity	0 -100 (%)	send level
20. OVERDRIVE	drive	0 -100 (%)	wet balance

REVERB parameter list

	<u>REVERB Time</u>	<u>REVERB Depth</u>
1. HALL 1	rev.time 0.3 - 5.0S	send level
2. HALL 2	rev.time 0.3 - 5.0S	send level
3. STAGE 1	rev.time 0.3 - 3.0S	send level
4. STAGE 2	rev.time 0.3 - 3.0S	send level
5. ROOM 1	rev.time 0.3 - 3.0S	send level
6. ROOM 2	rev.time 0.3 - 3.0S	send level
7. PLATE	rev.time 0.3 - 3.0S	send level

Note:

When EFX/REVERB depth is set to 0 while the EFX/REVERB button is active, the EFX/REVERB button will blink to indicate that the EFX/REVERB is turned ON but the depth is set to 0.

EFX rate and REVERB time are effective to internal zone only.

EFX type, EFX rate and EFX depth are common to all internal zones.

If the selected zone is set to BOTH, changing the value for EFX depth or REVERB depth affects for both internal and external sections. If you want different settings for internal and external sections, first enter the edit mode by pressing the MENU button and press the EFFECT button. Now you can select internal or external zone with ZONE SELECT button. (See page 29 for details.)

5.2 EQ (EQUALIZER)

The MP8 contains a four-band graphic equalizer to shape the overall tone of the sound. The EQ affects all zones at the same time. However, each SETUP can have its own EQ setting that affects the internal sounds only.

Be sure that the EQ button in the CONTROL KNOBS section is lit. If the EQ button is turned off, press it to turn it ON.

The CONTROL KNOBS are now active and assigned to the EQ parameters. Use the CONTROL KNOBS to change the current settings.

Each parameter of the EQ has an adjustable range from -12 to +12. A positive (+) value indicates amplification, or a boost of that frequency range. A negative (-) value indicates attenuation, or a cut of that frequency range.

Lo	Mlo	Mhi	Hi
+3	-2	+1	+2

5.3 TONE MODIFY

The MP8 allows certain characteristics of the sounds to be custom tailored to suit a particular musical or playing style, or to create many variations and

different types of sounds. TONE MODIFY settings can be done for each zone individually.

The following parameters are provided:

CUTOFF, ATTACK, DECAY and RELEASE.

Make sure that the TONE MODIFY button in the CONTROL KNOBS section is lit.

If the TONE MODIFY button is turned off, press it to turn it ON.

The CONTROL KNOBS are now active and assigned to the Tone Modify parameters for the current sound.

Use the CONTROL KNOBS to change the current settings for the selected zone.

Each parameter of the TONE MODIFY function has an adjustable range from -50 to +50.

CUT	ATK	DCY	RLS
+50	-20	+40	+10

CUTOFF: Raising the CUTOFF level makes the sound brighter, lowering the level makes the sound duller

ATTACK: As the value increases, the attack time becomes longer which means a slower attack is produced.

DECAY: This parameter controls the amount of time from the peak level to the sustain level of the sound.

RELEASE: This parameter controls the amount of time needed for the sound to fade out after the key is released.

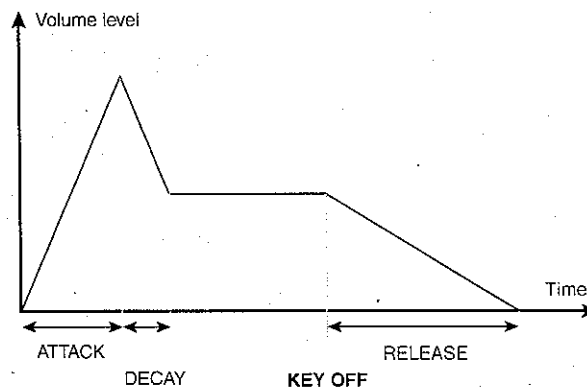

Note:

If the selected zone is set to BOTH, changing the TONE MODIFY parameters affects for both internal and external sections. If you want different settings for internal and external sections, enter the edit mode by pressing the MENU button and select internal or external section with ZONE SELECT button. (See page 29 for details.)

5.4 MIDI CC# (Control Change)

The MP8 can send any MIDI Continuous Controller information to any MIDI Instrument or Device.

This powerful feature allows for editing the sounds of an external sound module in Real Time during performance, or for recording Real Time performance edits to a MIDI sequencer.

Some control changes are also effective to internal sounds.

Make sure that the MIDI CC# button in the CONTROL KNOBS section is lit. If the MIDI CC# button is turned off, press it to turn it ON.

The CONTROL KNOBS are now active and assigned to the MIDI CC parameters. Use the CONTROL KNOBS to change the MIDI continuous controller information assigned to each knob as described below. Each parameter of the Control Change has an adjustable range from 0 to 127.

When the selected zone is set to INT or BOTH, the display shows the parameter names.

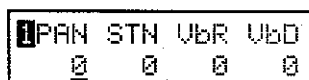

```
1 PAN STN VbR VbD
  0  0  0  0
```

When the selected zone is set to EXT, the display shows the MIDI CC numbers.

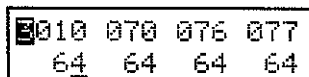

```
2 010 070 076 077
  64  64  64  64
```

The default parameters assigned for each knob are as follows.

- A: #10 Panpot (PAN)
- B: #70 Sustain Level (STN)
- C: #76 Vibrato Rate (VbR)
- D: #77 Vibrato Depth (VbD)

Note:

If the selected zone is set to BOTH, changing the MIDI CC# parameters affects for both internal and external sections. If you want different settings for internal and external sections, enter the edit mode by pressing the MENU button and select internal or external section with ZONE SELECT button. (See page 29 for details.)

Changing MIDI CC parameter

Press and hold the MIDI CC# button. The MIDI CC# button starts blinking and the cursor in the display moves up to the parameter name.



```
1 PAN STN VbR VbD
  0  0  0  0
```

Use the CONTROL KNOBS to change the parameters.

After changing the parameter, press the MIDI CC# button again. The MIDI CC# button stops blinking and the cursor in the display moves down to the value.

Note:

When the selected zone is set to INT, only the following parameters can be selected.

10	Panpot	PAN
11	Expression	EXP
70	Sustain Level	STN
71	Resonance	RSN
76	Vibrato Rate	VbR
77	Vibrato Depth	VbD
78	Vibrato Delay	VbY
93	Chorus Depth	ChD

When the selected zone is set to BOTH and the internal section is selected in edit mode, the parameters not available for INT section show as XXX.

```
015 STN VbR VbD
xxx  0  0  0
```

6. MENU

The MENU buttons allow access to the edit parameters in the MP8. This collection of settings together with other editable parameters can be stored as a SETUP. The MP8 provides 256 SETUPS, and all are user programmable.

A SETUP consists of four zones. Each zone can be set as Internal, External or Both individually. Inside each of the four zones, a multitude of features and effects can be programmed and combined together into one exciting SETUP.

A total of 256 SETUPS may be programmed in this way.

The menu consists of Internal parameters, External parameters and Common parameters.

Common parameter affects to all zones. If a zone is set as Both, both the Internal parameters and External parameters are available for the zone.

Use the MENU buttons to scroll through all the different parameters.

Zone parameters (Int)

Mode
Sound Selection
Damper Effect (Int Piano only)
String Resonance (Int Piano only)
Voicing (Int Piano only)
Key Range Hi/Lo
Velocity Switch On/Off
Velocity Switch Value
Velocity Compression
Velocity Offset
Zone Transpose
Volume
Pan
Fine Tune
Damper Pedal On/Off/Hold
Footswitch On/Off
Expression Pedal On/Off
Modulation On/Off
Bender On/Off
Bender Range
Solo On/Off
Solo Mode

Zone parameters (Ext)

Mode
TX Channel
TX PRG # On/Off
PRG #
TX Bank On/Off
Bank Select MSB LSB
Key Range Hi/Lo
Velocity Switch On/Off
Velocity Switch Value
Velocity Compression
Velocity Offset
Zone Transpose
TX Volume On/Off
Volume
TX Controller On/Off
Pan
Fine Tune
Damper Pedal On/Off
Footswitch On/Off
Expression Pedal On/Off
Modulation On/Off
Bender On/Off
TX Bender Range On/Off
Bender Range
Solo On/Off
Solo Mode

Common parameters

Master Volume
Expression Pedal CC#
Footswitch CC#
Temperament
Stretch Tuning

Caution:

The edited settings will be erased when the power is turned off, or other sound is recalled. To save these settings, use the STORE procedure to save them as a SETUP (see p.XX)

6.1 Editing Procedure and Parameters

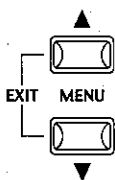

First, press the ZONE SELECT button for the zone to be edited.

Next, press the MENU buttons until the parameter you want to edit appears in the DISPLAY. When a zone is set as Both, pressing the ZONE SELECT button again will switch the menu list from Internal to External or vice versa.

Set the value of the parameter using the VALUE buttons.

Since each parameter has a different value range, consult the following pages for the details. Repeat this procedure for any other parameters in any of the zones that need to be modified.

Save these settings using the STORE button.
(See p.38 for detail)

Note:

Once you enter the edit mode from SETUP mode by pressing MENU button, the mode automatically changes to SOUND mode and the SOUND SELECT buttons are used to select sounds, not SETUPS.

You can exit the edit mode by pressing both MENU buttons simultaneously. Any edits you have made so far will be retained until another SETUP is recalled. If you exit the edit mode by pressing SOUND or SETUP buttons, your changes will be lost and the previously saved settings are recalled.

6.2 Edit Parameters

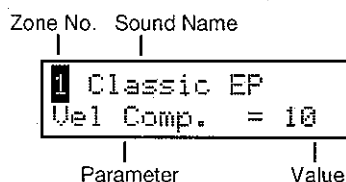

Zone parameters can be edited individually for each zone. There are two parameter groups, Internal parameter group and External parameter group. If a zone is set to Int, only Internal parameters are available for editing. If a zone is set to Ext, only External parameters are available for editing. If a zone is set to Both, both Internal and External parameters are available for editing.

6.2.1 Zone Mode

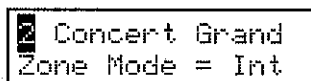

This parameter sets the Zone mode. The example shows that the Zone 2 is set to Internal.

6.2.2 Sound (Int only)

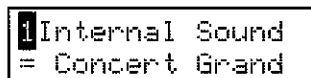

This parameter determines which internal sound is assigned for the selected zone.

6.2.3 Voicing (Int Piano only)

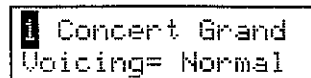

This parameter re-creates electronically the voicing technique of adjusting the action, hammers and strings on an acoustic piano to change the tone character. This function is a very powerful way to enhance and customize

the piano response for each player and each sound.

The effect is only available for the internal piano sounds. Other sounds cannot use this parameter.

Normal: Produces the normal tone of an acoustic piano throughout the entire dynamic range.

Mellow: Reproduces the effect of a softer hammer surface. It produces a mellower tone throughout the entire dynamic range.

Dynamic: This setting is not possible with an acoustic piano. Softly played notes will have the tone of a mellow voicing and notes played harder will have the tone of a bright voicing. This setting produces a dramatic change from mellow to bright throughout the entire dynamic range.

Bright: Produces a brighter tone throughout the entire dynamic range.

6.2.4 Damper Effect (Int Piano only)

```
1 Concert Grand
  DamperEffect= 5
```

When the sustain pedal is depressed, the volume of the whole resonance can be changed to the level you prefer. The value changes from 0 (off) to 10.

* The display shows this parameter only when Piano sound is selected.

6.2.5 String Resonance (Int Piano only)

The volume of string resonance can be changed to the level you prefer. The value changes from 0 (off) to 10.

<String Resonance>

```
1 Concert Grand
  String Reso.= 5
```

In acoustic pianos, there are strings corresponding to each key. When a key is pressed, strings of other keys in the related harmonic series to the note played resonate. This effect is called "sound resonance", which makes the sound of acoustic piano full and rich.

* The display shows this parameter only when Piano sound is selected.

6.2.6 TX Ch (Ext only)

```
3 External
  TX Channel = 1
```

This parameter sets the MIDI transmit channel for the selected zone. All MIDI data for the selected zone will be transmitted on this channel. Make sure that the receiving channel for any external MIDI devices to be controlled from this zone is set to the same channel as the zone.

6.2.7 TX Prg # (Ext only)

```
3 External
  TX Prg # = On
```

This parameter determines if a Program Change Number will be transmitted (On) or not (Off) when a SETUP is recalled. If you want to switch sounds on external MIDI devices every time you call the Setup turn this parameter ON.

6.2.8 Prg # (Ext only)

```
3 External
  Prg # = 001
```

This parameter determines which Program Change Number will be transmitted when a SETUP is recalled. When the TX Prg # is set to Off, this page won't be displayed. Select the desired PRG number for the sound you want to select on the external MIDI device.

6.2.9 TX Bank (Ext only)

```

External
TX Bank = On
    
```

This parameter determines if Program Bank Numbers (MSB, LSB) will be transmitted (On) or not (Off) when a SETUP is recalled. If your external MIDI device requires a Bank Select message, turn on this function.

6.2.10 Bank MSB/LSB (Ext only)

```

ExternalMSB LSB
Bank = 000 000
    
```

This parameter determines which MSB and LSB Number will be transmitted when this SETUP is recalled. When the TX Bank is set to Off, this page won't be displayed.

In the MIDI standard, there are 128 storage spaces. The number of storage spaces can be expanded using an MSB and an LSB.

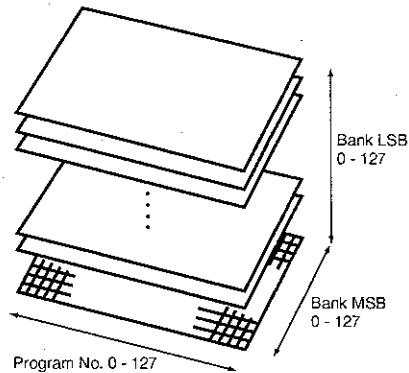

This is a 3D image of the expanded program change system with the MSB and LSB. To use these efficiently and correctly, refer to the operation manual of any external MIDI sound modules that are connected to the MP8.

6.2.11 Key Range Hi/Lo

```

Concert Grand
K.Range Hi =G8
    
```

```

Concert Grand
K.Range Lo =C-2
    
```

These two parameters define the playable key range on the keyboard for the selected zone. First, while K.Range Hi appears in the display use the VALUE buttons to set the highest note that the selected zone can play. Next, while K.Range Lo appears in the display, use the VALUE buttons to set the lowest note that the selected zone can play.

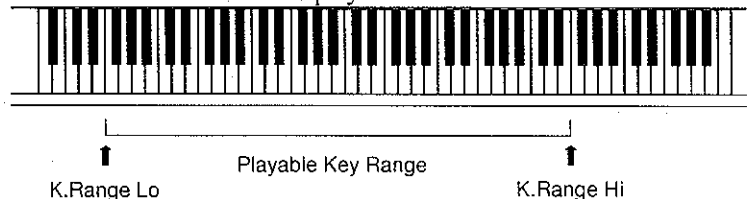

Note:

Another convenient way to input the keyrange is to hold the ZONE SELECT button of the desired zone for more than 1 second and input the K.Range Lo by pressing the lowest key followed by the key of the highest note, while still holding the ZONE SELECT button.

6.2.12 Velocity Switch

Concert Grand
Vel SW = Loud

Velocity switching is an extremely useful and creative tool for customizing a performance. Using Velocity Switching, it is possible to have either one sound switch to another sound at a set velocity, or even for a second sound to be added in once a certain velocity has been reached, or to have a sound drop out above or below a set velocity level. This parameter sets the velocity switch type.

Off : No effect. The sound plays normally

Loud: The selected sound plays only when the key is struck harder than the Vel SW Val. (See next parameter)

Soft : The selected sound plays only when the key is struck softer than the Vel SW Val. (See next parameter)

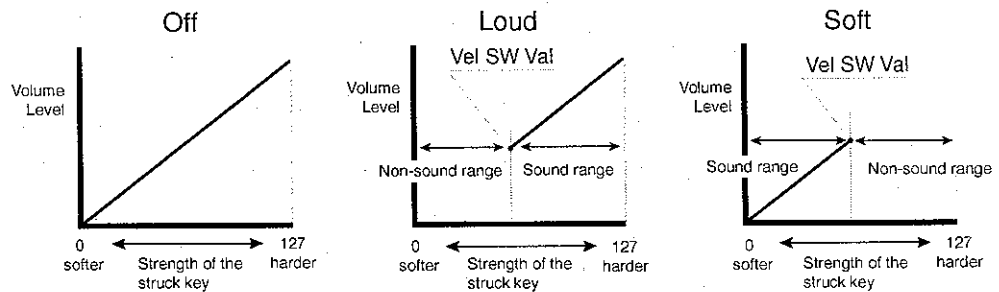

6.2.13 Velocity Switch Value

Concert Grand
Vel SW Val = 80

This parameter determines switching level of the key velocity

For the Loud Vel SW : determines the lowest key velocity to sound.

For the Soft Vel SW : determines the highest key velocity to sound.

Note:

Each zone can have a separate Velocity Switch Value. By setting the Soft Zone Velocity Switch Value higher than that of the Loud Zone a dynamic area where both sounds play can be created. It is also possible to switch Internal Zones with External Zones for even more possibilities.

6.2.14 Velocity Compression

Concert Grand
Vel Comp. = 10

This parameter adjusts the keyboard response.

When the value is 10 (default), the keyboard response is normal (same as the setting in the SYSTEM).

When the value comes closer to 0, the keyboard response becomes less dynamic and at 0, it becomes completely flat (no touch response).

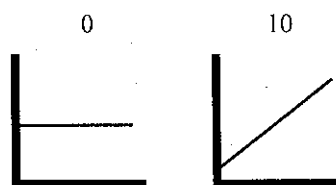

Vertical Line: Velocity Compression

Horizontal Axis: Strength of the struck key

6.2.15 Velocity Offset

1 Concert Grand
Vel Offset = 100

This parameter sets the velocity value used, when Velocity Compression is lower than 10.

For example to get a "No-Velocity" Organ type of playing feeling, set Velocity Compression to 0 and adjust the velocity level with this parameter to 100 or any other wanted level of velocity. If Velocity Compression is set to 10, Velocity Offset has no effect.

6.2.16 Zone Transpose

1 Concert Grand
Zone Trans. = 0

This parameter sets the amount of transposition for the selected zone. The available range is three octaves up or down (+/-36 semitones).

Note:

To set the master transpose, press the **TRANPOSE** button and set the value.

6.2.17 Transmitting Volume (Ext only)

External
TX Volume = On

This parameter determines if an initial MIDI Volume message will be transmitted (On) to an external MIDI device or not (Off) when a SETUP is recalled.

Note:

In a zone set to **External** or **Both**, moving the faders will still transmit volume messages even if TX Volume is set to Off.

6.2.18 Volume

1 Concert Grand
Volume = 0

This parameter sets the volume level for the selected zone. The value can be changed by using the **FADER** or **VALUE** buttons.

For External zones, when the TX Volume is "Off", this page won't be displayed.

6.2.19 Transmitting Control Change (Ext only)

External
TX Cntrl# = On

This parameter determines if the Pan/Fine Tune/Control Knob settings will be transmitted (On) via MIDI or not (Off) when a SETUP is recalled.

Note:

In a zone set to **External** or **Both**, moving the Control Knobs will still transmit the values even if TX CC is set to Off.

6.2.20 Pan

1 Concert Grand
Pan = 0

Int: This sets the pan-pot (right and left balance).

Ext: This sets the pan-pot value that will be transmitted to external sound modules. If the TX CC is "On", the value is transmitted when a SETUP is recalled. When the TX CC is "Off", this page won't be displayed.

The value changes from L63 to R63.

6.2.21 Fine Tune

```
1 Concert Grand
Fine Tune = 0
```

Int: This is a fine tuning function for values smaller than a semi-tone.

Ext: This is used to transmit fine tuning settings to external sound modules. If the TX CC is "On", the value is transmitted when a SETUP is recalled. When the TX CC is "Off", this page won't be displayed.

The value changes from -63 to +63.

6.2.22 Damper

```
1 Concert Grand
Damper = Norm
```

This parameter determines if the damper pedal is active (Norm [Int] / On [Ext], with natural decay), deactivated (Off) or set to HOLD (On, with steady sustain level) for the selected zone.

Use the HOLD value, if you don't want a sound to disappear. HOLD is only available for internal Sounds.

6.2.23 Foot Switch

```
1 Concert Grand
Foot Sw = On
```

This parameter determines if a Foot Switch connected to the FSW jack is active (On) or not (Off) for the selected zone. The type of controller assigned to the footswitch is a common Setup parameter and is used for all zones of a Setup as a global parameter.

6.2.24 Expression Pedal

```
1 Concert Grand
Exp Pedal = On
```

This parameter determines if an Expression Pedal connected to the EXP jack is active (On) or not (Off) for the selected zone. The type of controller assigned to Expression pedal is a common Setup parameter and is used for all zones of a Setup as a global parameter.

6.2.25 Modulation

```
1 Concert Grand
Modulation = On
```

This parameter determines if the Modulation Wheel is active (On) or not (Off) for the selected zone.

6.2.26 Bender

```
1 Concert Grand
Bender = On
```

This parameter determines if the Bender Wheel is active (On) or not (Off) for the selected zone.

6.2.27 Transmitting Bender Range (Ext only)

```
3 External
TX BendRng = On
```

This parameter decides if a Bender Range should be transmitted (On) or not (Off) when a SETUP is recalled. When the Bender is "Off", this page won't be displayed.

6.2.28 Bender Range

```
1 Concert Grand  
Bendr Rng = 2
```

Int: This sets the Bender Range in semitone steps. The value changes from 0 to 7.

Ext: This is used to transmit Bender Range information to external sound modules. If the Tx Bender Range is "On", the value is transmitted when a SETUP is recalled. The value changes from 0 to 12.

When the Bender is "Off", this page won't be displayed.

6.2.29 Solo

```
1 Concert Grand  
Solo = On
```

This parameter turns the Solo Mode On/Off.

When Solo is turned "On" only one note will be heard for the selected zone even if more than one note is being played simultaneously. This can be used to effectively simulate the performance characteristics of a monophonic synthesizer or as a special performance tool for playing solo parts. Solo mode can also be used while playing a polyphonic part from another zone.

6.2.30 Solo Mode

```
1 Concert Grand  
Solo Mode =Last
```

This parameter determines which note will be played when Solo is ON and more than one note is being played simultaneously. There are three choices for Solo note priority.

Last: The most recently played note within a group of notes will be heard when Solo is ON

Hi: The highest note played within a group of notes will be heard when Solo is ON.

Low: The lowest note played within a group of notes will be heard when Solo is ON.

When the Solo is "Off", this page won't be displayed.

6.3 Common Parameters

Common parameters are affecting all zones.

6.3.1 Stretch Tuning

```
COMMON  
Stretch = Piano_W
```

The hearing ability of a human is uneven and is not accurate with high frequency and low frequency as it is with the middle range. The tuning of an acoustic piano is stretched to compensate for this so the sound will be heard naturally to the ears.

Off: The tuning is flat without stretching.

On: The tuning is always stretched.

Piano: The tuning is stretched only when piano sounds are selected.

On W: Same as "On" but the stretching is wider

Piano W: Same as "Piano" but the stretching is wider

6.3.2 Temperament

This parameter sets the temperament of the MP8.

```
COMMON  
Tempr = Pure Maj
```

- Equal:** This is the most popular tuning method that divides the scale into twelve equal semitones. This produces the same chordal intervals in all twelve keys, and has the advantage of limitless modulation of the key. However the tonality of each key becomes less characteristic and no chord is in pure consonance.
- Pure Maj:** This temperament, which eliminates dissonances for thirds and fifths is still popular for choral music because of its perfect harmony. When playing in a major key select "Pure Maj" and when playing in a minor key select "Pure Min".
- (Min):**
- Pythagor:** This temperament, which uses mathematical ratios to eliminate dissonance for fifths, is very limited for use with chords, but it produces very characteristic melodic lines.
- Meantone:** This temperament, which uses a mean between a major and minor whole tone to eliminate dissonance for thirds, was devised to eliminate the lack of consonances experienced with certain fifths for the Mersenne pure temperament. It produces chords that are more beautiful than those with the equal temperament.
- Werkmeis:** These two temperaments are placed in between Meantone and Kirnberg:
- Kirnberg:** Pythagorean. For music with few accidentals, this temperament produces the beautiful chords of the mean tone, but as accidentals increase, the temperament produces the characteristic melodies of the Pythagorean temperament. It is used primarily for classical music written in the Baroque era to revive the original characteristics.
- User:** You can make your own temperament by raising or lowering the pitch for each half tone.

6.3.3 Key of Temperament

```
COMMON  
TemprKey = C
```

Limitless modulation of the key became available only after the invention of Equal temperament. When we use a temperament other than Equal temperament, we must carefully choose the key signature to play in. For example, if the song you are going to play is written in D major, choose "D" as the temperament key. When Temperament is set to Equal, this page won't be displayed.

6.3.4 Tuning C - B

```
COMMON  
C = 0
```

When the temperament is set to "User", adjust the pitch for each key and create your own temperament. The value changes from -50 to +50. These pages will only be displayed when the user temperament is selected.

Note:

The value is shown in "cent". Half tone equals to 100 cents.

6.3.5 FSW Control Change Number

COMMON
FootSW CC# = SST

This parameter assigns a Control Change Number to the Footswitch connected to the FSW jack on the rear panel.

See page 58 for the list of Control Change numbers.

If the SW is selected, the footswitch is used to turn on/off the SW button.

When the System parameter FootSW is "Setup+" this page won't be displayed.

6.3.6 EXP Control Change Number

COMMON
ExpPdl CC# = EXP

This parameter assigns a Control Change Number to the Expression Pedal connected to the EXP jack on the rear panel.

See page 58 for the list of Control Change numbers.

If the AFT is selected, the expression pedal is used to send After Touch information.

If the "Pedal Wah" is selected in EFX, the pedal works as a Wah Pedal regardless of the setting in this parameter.

Note:

When the following Numbers are selected for the FSW Control Change Number or the EXP Control Change Number, the functions affect the internal sounds, too.

1. Modulation Wheel (MOD)
7. Volume (VOL)
10. Pan (PAN)
11. Expression Controller (EXP)
64. Damper Pedal (HLD)
66. Sostenuato (SST)
67. Soft Pedal (SFT)

6.3.7 Master Volume

COMMON
Master Vol = 127

Adjust the total volume of the SETUP.

The value changes from 0 to 127.

7. STORE



You can save the changes of the settings you made as a SETUP. You can store up to 256 SETUPS.

The following groups of parameters are stored in a SETUP

- Sound Selection, Zone On/Of Status (see p. 12)
- Fader, Control Knob settings (see p. 13, 23)
- EFX/REVERB settings (see p.21)
- Function SW setting (see p.17)
- MATER TRANSPOSE setting (see p.15)
- MENU settings (see p.28)

7.1 Storing the settings as a SETUP

Press the STORE button. The display will show the SETUP number to store.

```
Store to 1-1-A  
= GrandPno+Str1
```

Use the SOUND SELECT buttons to change the SETUP number to store. For example, to choose SETUP 2-3-B, press 2 in the upper row, press 3 in the second row, and press B in the third row. Then press the STORE or VALUE UP button.

```
Set Name  
= GrandPno+Str1
```

To set a name use the MENU buttons to move the cursor use the VALUE buttons to select the character. After you re-name the SETUP, press the STORE button again.

```
Are You Sure?  
Press VALUE UP
```

Now press the VALUE UP button to confirm. You can cancel the STORE procedure at any time by pressing any other button which is not used during the STORE procedure.

```
Writing Memory,  
Completed!
```

Note:

Storing will overwrite the selected SETUP

8. SYSTEM



Use this mode to set the System parameters of MP8.
To enter the SYSTEM mode, press the SYSTEM button.

8.1 System Menu

Use the MENU buttons to scroll through the System parameters.

[System Parameter]

System Channel

Init. SW

Touch

System Tune

Volume Slider Action

Local Control On/Off

Multitimbre On/Off

Receive Channel On/Off

LCD Contrast

LED Brightness

Out Mode

Foot SW

[System Dump]

Dump Current

Dump All

[System Reset]

Reset One SETUP

Reset All

[System EFX/REVERB]

Reset EFX/REVERB

Save EFX/REVERB

Make sure the SYSTEM button is lit.

Press the MENU buttons until the parameter you want to edit appears in the DISPLAY.

Set the value of the parameter by using the VALUE buttons.
The value range differs depending on the parameter.

8.2 System Parameters

The System Menu parameters are global and always stored automatically when leaving the SYSTEM mode, so there is no need to store them.

8.2.1 System Channel

```
SYSTEM
System Ch = 1
```

This parameter sets the System MIDI channel on which System Exclusive messages are transmitted/received.

8.2.2 Initial SW

```
SYSTEM
Init. SW =PnlLck
```

PnlLck: Panel Lock (See P.18)
 TchCuv: Touch Curve (See P.18)
 RtrSpd: Rotary Slow/Fast (See P.18)
 EQBps: EQ Bypass On/Off (See P.19)
 WhlLck: Wheel Lock (See P.19)
 FSWLck: Foot Switch Lock (See P.20)
 EXPLck: Expression Lock (See P.20)
 ExtSeq: External Sequencer Start/Stop (See P.21)

8.2.3 Touch

```
SYSTEM
Touch =Normal
```

This parameter adjusts the touch response curve of the keyboard.

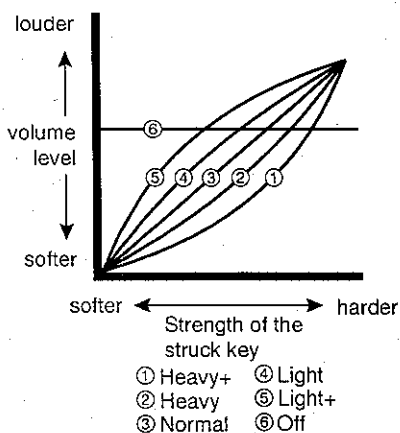

Heavy+: This Curve has a steep rise as velocity increases, and a shallower curve at low velocities. (see 1) This curve requires the most striking force to produce a loud volume.

Heavy: This curve requires a stronger striking force to produce a loud volume. (see 2) This curve is perfect for those with strong fingers.

Normal: This curve recreates the touch response of an average acoustic piano.

Light: This curve requires less striking force to produce a loud volume. (see 4) This curve is good for those still developing finger strength.

Light+: This curve requires the least amount of striking force to produce a loud volume. (see 5) This curve is good for those with a very delicate touch.

Off: This curve gives a constant velocity level no matter how hard the keyboard is struck. (see 6) This curve is suitable for sounds that have a fixed dynamic range such as Organ, Harpsichord and certain synthesizer sounds.

User1,2: You can create your own custom touch curve to fit your playing style. Two user touch curves can be saved.

User Touch

The touch curve is the main component between the action and the sound. With this User Touch Curve function you can customize the MP8 according to your personal playing style.

After selecting the "Touch" function by pressing the MENU buttons, use the VALUE buttons to select User 1 or User 2. Now the selected curve is activated.

```
Press STORE
Touch =User1
```

To create your own personal touch curve press the STORE button.

```
Start playing  
Soft - Loud
```

Now start playing the piano dynamically from soft to loud in order to let the piano analyze your playing style. Make sure that you really play in a realistic way according to your finger power and feeling. Sometimes the result is better if you turn off the volume first.

```
Press STORE  
when finished
```

Press the STORE button again when you finish playing.

```
Analysis  
Completed!!
```

The piano will analyze your playing and create a custom touch curve for you based upon your playing style. The new curve is automatically saved and will be used until you change the touch curve again or record a new one.

8.2.4 System Tuning

```
SYSTEM  
SysTune = 440.0
```

This parameter sets the global master tuning of the MP8. The value changes from 427.0 to 453.0 (Hz).

8.2.5 Volume Slider Action

```
SYSTEM  
VolAction=Catch
```

This selects how the volume sliders react, when you change the volume.

Normal: The value changes immediately, when the volume slider is moved.
Catch: The value won't change until the volume slider catches the position of the previously saved Volume value. This setting is designed for live editing to prevent you from unexpected volume jumps.

8.2.6 Local Control

```
SYSTEM  
Local = On
```

On: The keyboard of the MP8 and the internal tone generators are connected. Set this parameter to "On" for normal use.
Off: The internal connection between the keyboard and the tone generators is switched off. This feature will avoid the "Doubled Sound" that results from use with an external sequencer equipped with Soft Thru or Echo Thru.

8.2.7 Multi-Timbral Mode

```
SYSTEM  
Multitimbre= Off
```

Multi-Timbral Mode allows the MP8 to receive data on more than one MIDI channel simultaneously. In this mode, the MP8 can play different musical parts with different sounds for each part.

- On: This is a flexible 16 part multi-timbral setup. (On 1 and On 2) MP8's normal program change numbers are assigned in On 1, and General MIDI program change numbers are assigned in On 2. (please see page XX for a list of the program change numbers.)
- Off: This turns off the multi-timbral capability. Only the system channel will be active and only the preset sound currently selected will be heard when a MIDI signal is received.

8.2.8 Receive Channel

```
SYSTEM  
RX Ch 1 = On
```

This parameter determines whether or not a particular MIDI channel will receive incoming MIDI data from an external source. This parameter can be used to filter out data on specific MIDI channels that are not intended for the MP8.

- On: The MP8 responds to MIDI data received on this channel.
- Off: The MP8 ignores MIDI data received on this channel.

When the Multi-Timbral Mode is set to Off, this page won't be displayed.

8.2.9 LCD Contrast

```
SYSTEM  
LCD Cont. = 10
```

This parameter adjusts the contrast of the LCD display. As the value changes higher, the contrast gets sharper. The value changes from 0 to 10.

8.2.10 LED Brightness

```
SYSTEM  
LED Bright.=High
```

This adjusts the brightness of the LEDs. You can choose from High or Low. The Low setting is designed for dark stages, while the High setting is good for bright ambience.

8.2.11 Out Mode

```
SYSTEM  
Out Mode =Stereo
```

Sometimes it is convenient to have two mono outputs instead of a stereo output.

In this case one mono output can be used for your own monitor system and the other goes to the mixing console.

- Stereo: The signal on the Line-Outs is normal stereo.
- 2xMono: The signal on the Line-Outs is mono on both jacks

Note:

To avoid unexpected sounding some stereo effects like AutoPan will be turned off, when 2xMono is selected.

8.2.12 Foot Switch Mode

This parameter sets the mode of FootSW's function.

```
SYSTEM
FootSW =Normal
```

Normal: The type of controller assigned to the footswitch is a common Setup parameter "FootSW CC#". (See P.39)

Setup+: The footswitch is pushed 1 time, and Setup number will be increased by 1.

Note:

When the value is "Setup+", FootSW CC# page won't be displayed.

8.3 System Dump

8.3.1 Dump Current

This function transmits the current and active settings of the MP8 as a System Exclusive Message via the MIDI OUT.

```
Dump Current
Press VALUE UP
```

Press the SYSTEM button. Then press the MENU-UP button until "Dump Current" appears on the display.

Press the VALUE-UP button. The display will ask for confirmation.

```
Dump Current
Sure?
```

To cancel Dump Current at this point, press the VALUE-DOWN button. Otherwise, press the VALUE-UP button again.

The display will change to read "Completed!!". Dump Current is complete.

```
Dump Current
Completed!!
```

Note:

Loading the data back to the MP8 will change the current settings. SETUP and SYSTEM data will not change. You can use this function to temporarily change the setting from your sequencer. If you want to save the setting, you must use the STORE procedure and save as Setup.

8.3.2 Dump All

This function transmits all the Setups of the MP8 as System Exclusive Messages via the MIDI OUT. Use this function to backup your Setups on an external MIDI sequencer.

```
Dump All
Press VALUE UP
```

Press the SYSTEM button. Then press the MENU-UP button until "Dump All" appears on the display.

Press the VALUE-UP button. The display will ask for confirmation.

```
Dump All
Sure?
```

To cancel Dump All at this point, press the VALUE-DOWN button. Otherwise, press the VALUE-UP button again.

When the data is done transmitting, the display will change to read "Completed!!". Dump All is complete.

```
Dump All
Completed!!
```

Note:

Loading the data back to MP8 will overwrite all the data in the memory.

8.4 System Reset

8.4.1 Reset One SETUP

This function resets one SETUP back to the original factory default settings.

```
Reset 6-4-A  
Press VALUE UP
```

Press the SYSTEM button. Use the MENU buttons to select "Reset X-X-X" (X-X-X stands for the setup number). Now use the SOUND SELECT buttons to select the setup you want to reset.

```
Reset 6-4-A  
Sure?
```

Press the VALUE-UP button. The display will ask for confirmation.

To cancel the Reset procedure at this point, press the VALUE-DOWN button. Otherwise, press the VALUE-UP button again.

```
Reset 6-4-A  
Completed!!
```

The display will show "Completed!!" after finishing.

Note:

The selected SETUP data will be overwritten by the factory settings. If you are in Sound mode, this function is not available.

8.4.2 Reset All

This function performs a global reset of all 256 SETUPS and SYSTEM settings back to the original factory default settings.

```
Reset All  
Press VALUE UP
```

Press the SYSTEM button. Use the MENU buttons to select "ResetAll".

```
Reset All  
Sure?
```

Press the VALUE-UP button. The display will ask for confirmation.

To cancel Reset All at this point, press the VALUE-DOWN button. Otherwise, press the VALUE-UP button again.

```
Reset All  
Completed!!
```

The display will show "Completed!!" after finishing.

Note:

All the data in the MP8 will be overwritten by the factory settings.

8.5 System EFX/REVERB

Each internal sound has a preset effect assigned as the default. These functions change the default of the EFX/REVERB settings.

Note: If you are not in Sound mode this function is not available.

8.5.1 Save EFX/REVERB

This function saves the EFX/REVERB settings of the selected one sound.

```
SAVE EFX/REVERB
Press VALUE UP
```

Press the SYSTEM button. Use the MENU buttons to select "Save EFX/ REVERB".

```
SAVE EFX/REVERB
      Sure?
```

Press the VALUE-UP button. The display will ask for confirmation.

To cancel Save EFX/REVERB at this point, press the VALUE-DOWN button. Otherwise, press the VALUE-UP button again.

```
SAVE EFX/REVERB
Completed!!
```

The display will show "Completed!!" after finishing.

8.5.2 Reset EFX/REVERB

This function resets the EFX/REVERB settings of the selected one sound back to the original factory default settings.

```
Reset EFX/REVERB
Press VALUE UP
```

Press the SYSTEM button. Use the MENU buttons to select "Reset EFX/ REVERB".

```
Reset EFX/REVERB
      Sure?
```

Press the VALUE-UP button. The display will ask for confirmation.

To cancel Save EFX/REVERB at this point, press the VALUE-DOWN button. Otherwise, press the VALUE-UP button again.

```
Reset EFX/REVERB
Completed!!
```

The display will show "Completed!!" after finishing.

9. OTHER

9.1 MIDI IN

When the Multi-Timbral Mode is Off, the MP8 receives the MIDI information coming in the System Channel only. (See page 39.)

For changing the internal sounds via MIDI, refer to the SOUND Program Number List on the next page.

Note:

If the MP8 receives the Program Number from 1 to 128 and Bank number LSB from 2 to 3 in the System Channel (See page 39.), the MP8 will switch to SETUP mode and the corresponding SETUP is recalled. (See the SETUP Program Number Table below.) The recalled SETUP can be played only from the keyboard of the MP8.

When the Multi-Timbral Mode is On, the MP8 can be used as a multi-timbral sound module, playing up to 16 different sounds on 16 MIDI channels.

9.2 SETUP Program Number Table

UPPER	SECOND	THIRD	PROG#:MSB-LSB
1	1	A	001:000-002
1	1	B	002:000-002
1	1	C	003:000-002
1	1	D	004:000-002
1	2	A~D	005:000-002 ~ 008:000-002
1	3	A~D	009:000-002 ~ 012:000-002
1	4	A~D	013:000-002 ~ 016:000-002
1	5	A~D	017:000-002 ~ 020:000-002
1	6	A~D	021:000-002 ~ 024:000-002
1	7	A~D	025:000-002 ~ 028:000-002
1	8	A~D	029:000-002 ~ 032:000-002
2	1~8	A~D	033:000-002 ~ 064:000-002
3	1~8	A~D	065:000-002 ~ 096:000-002
4	1~8	A~D	097:000-002 ~ 128:000-002
5	1~8	A~D	001:000-003 ~ 032:000-003
6	1~8	A~D	033:000-003 ~ 064:000-003
7	1~8	A~D	065:000-003 ~ 096:000-003
8	1~8	A~D	097:000-003 ~ 128:000-003

9.3 SOUND Program Number List

			Multi Timbre ON1			Multi Timbre ON2		
			Prog#	Bank MSB	Bank LSB	Prog#	Bank MSB	Bank LSB
Piano								
1	A	Concert Grand	1	0	0	1	121	0
	B	Studio Grand	2	0	0	1	121	1
	C	Mellow Grand	3	0	0	1	121	2
	D	Jazz Grand	4	0	0	1	95	8
2	A	Concert Grand2	5	0	0	1	95	16
	B	Studio Grand 2	6	0	0	1	95	17
	C	Mellow Grand 2	7	0	0	1	95	18
	D	Jazz Grand 2	8	0	0	1	95	19
3	A	Modern Piano	9	0	0	2	121	0
	B	Rock Piano	10	0	0	2	121	1
	C	Old Age Piano	11	0	0	2	95	5
	D	Honky Tonk	12	0	0	4	121	0
4	A	Mono Piano	13	0	0	1	95	20
	B	Mono Piano 2	14	0	0	1	95	3
	C	Mono Piano 3	15	0	0	1	95	21
	D	Mono Piano 4	16	0	0	1	95	24
5	A	Piano Vari.	17	0	0	1	95	22
	B	Piano Vari. 2	18	0	0	1	95	23
	C	Piano Vari. 3	19	0	0	2	95	6
	D	Piano Vari. 4	20	0	0	2	95	7
6	A	Piano Oct.	21	0	0	1	95	1
	B	Piano Oct. 2	22	0	0	1	95	2
	C	Piano & EP	23	0	0	2	95	1
	D	Piano & EP 2	24	0	0	2	95	2
7	A	New Age Piano	25	0	0	1	95	9
	B	New Age Piano2	26	0	0	1	95	10
	C	New Age Piano3	27	0	0	1	95	11
	D	New Age Piano4	28	0	0	1	95	15
8	A	Harpsichord	29	0	0	7	121	3
	B	Harpsichord2	30	0	0	7	121	0
	C	Harpsi. Octave	31	0	0	7	121	1
	D	Harpsi & Clavi	32	0	0	7	95	5
E.Piano								
1	A	Classic EP	33	0	0	5	121	0
	B	Classic EP 2	34	0	0	5	95	5
	C	Classic EP 3	35	0	0	5	95	3
	D	Classic EP 4	36	0	0	5	121	1
2	A	Modern EP	37	0	0	6	121	0
	B	Modern EP 2	39	0	0	6	121	1
	C	Modern EP 3	40	0	0	6	121	2
	D	Modern EP 4	38	0	0	6	95	5
3	A	60s EP	41	0	0	5	121	3
	B	60's EP 2	42	0	0	5	95	4
	C	Electric Grand	44	0	0	3	121	0
	D	Electric GP 2	43	0	0	3	121	1
4	A	Dolce EP	45	0	0	5	95	2
	B	Legend EP	46	0	0	6	121	3
	C	Phase EP	47	0	0	6	121	4
	D	Classic EP 5	48	0	0	5	121	2

			Multi Timbre ON1			Multi Timbre ON2		
			Bank	Bank		Bank	Bank	
			Prog#	MSB	LSB	Prog#	MSB	LSB
5	A	Crystal EP	49	0	0	6	95	1
	B	New Age EP	50	0	0	6	95	2
	C	New Age EP2	51	0	0	6	95	3
	D	New Age EP3	52	0	0	6	95	4
6	A	Clavinet	53	0	0	8	121	0
	B	Synth Clavinet	54	0	0	8	121	1
	C	Clavi & Marim	55	0	0	8	95	1
	D	Clavi Phaser	56	0	0	8	95	2
7	A	Vibraphone	57	0	0	12	121	0
	B	Octave Vibes	58	0	0	12	95	2
	C	Celesta	59	0	0	9	121	0
	D	Bells	60	0	0	15	95	3
8	A	Marimba	61	0	0	13	121	0
	B	Hard Marimba	62	0	0	13	95	1
	C	Xylophone	63	0	0	14	121	0
	D	Steel Drums	64	0	0	115	121	0
Drawbar								
1	A	Be More	65	0	0	17	95	2
	B	Jazzier	66	0	0	18	95	1
	C	Be 3	67	0	0	17	95	1
	D	Be Nice	68	0	0	17	95	7
2	A	Mellow	69	0	0	17	95	5
	B	Drawbar 2	70	0	0	17	121	3
	C	Odd Man	71	0	0	17	95	6
	D	Hi-Lo	72	0	0	17	95	3
3	A	Soft Solo	73	0	0	17	95	8
	B	Full Organ	74	0	0	18	95	4
	C	Jazz Organ 2	75	0	0	18	95	12
	D	Hollow	76	0	0	18	95	6
4	A	Rock Organ 2	77	0	0	19	121	0
	B	Drawbar 3	78	0	0	17	121	1
	C	Screamin'	79	0	0	17	95	4
	D	Drawbar	80	0	0	17	121	0
5	A	Jazz Organ	81	0	0	18	121	0
	B	Rock Organ	82	0	0	18	95	13
	C	Perc. Organ 2	83	0	0	18	121	1
	D	Perc. Organ	84	0	0	18	95	15
6	A	16' Drawbar	85	0	0	19	95	1
	B	8' Drawbar	86	0	0	19	95	2
	C	5 1/3' Drawbar	87	0	0	19	95	3
	D	4' Drawbar	88	0	0	19	95	4
7	A	2 2/3' Drawbar	89	0	0	19	95	5
	B	2' Drawbar	90	0	0	19	95	6
	C	1 3/5' Drawbar	91	0	0	19	95	7
	D	1 1/3' Drawbar	92	0	0	19	95	8
8	A	1' Drawbar	93	0	0	19	95	9
	B	4' percussion	94	0	0	18	95	3
	C	2 2/3' perc.	95	0	0	18	95	2
	D	Key Click	96	0	0	122	95	1

			Multi Timbre ON1			Multi Timbre ON2		
			Bank	Bank		Bank	Bank	
			Prog#	MSB	LSB	Prog#	MSB	LSB
Organ								
1	A	Church Organ	97	0	0	20	121	0
	B	Full Pipes	98	0	0	20	95	9
	C	Full Ensemble	99	0	0	21	95	10
	D	Church Organ 2	100	0	0	20	121	1
2	A	PrincipleChoir	101	0	0	20	95	23
	B	Small Ensemble	102	0	0	20	95	8
	C	Small Ens. 2	103	0	0	20	95	25
	D	Baroque	104	0	0	20	95	19
3	A	Chiffy Tibia	105	0	0	20	95	17
	B	8'&4' Principle	106	0	0	20	95	24
	C	Stopped Pipe	107	0	0	20	95	21
	D	Principle Pipe	108	0	0	20	95	22
4	A	8' Celeste	109	0	0	20	95	5
	B	Diapason	110	0	0	20	95	6
	C	Voice Celeste	111	0	0	20	95	39
	D	Baroque Mix	112	0	0	20	95	7
5	A	Reeds	113	0	0	20	95	10
	B	8' Reed	114	0	0	21	95	1
	C	Reed Pipes	115	0	0	20	95	26
	D	Posaune	116	0	0	20	95	27
6	A	Theater Organ	117	0	0	20	95	2
	B	Theater Organ2	118	0	0	20	95	3
	C	Theater Organ3	119	0	0	20	95	4
	D	Theater Tibia	120	0	0	20	95	36
7	A	Elec. Organ	121	0	0	17	95	9
	B	Elec. Organ 2	122	0	0	17	95	10
	C	60's Organ	123	0	0	17	121	2
	D	Pump Organ	124	0	0	20	95	40
8	A	Fr. Accordion	125	0	0	22	121	0
	B	TangoAccordion	126	0	0	24	121	0
	C	Harmonica	127	0	0	23	121	0
	D	Kenban Harmo.	128	0	0	23	95	4
Strings/Vocal								
1	A	String Pad	1	0	1	49	95	8
	B	Warm Strings	2	0	1	49	95	1
	C	Warm Strings 2	3	0	1	51	121	0
	D	Synth Strings	4	0	1	52	121	0
2	A	Beautiful Str.	5	0	1	45	95	1
	B	String Ens. 2	6	0	1	50	121	0
	C	String Ens.	7	0	1	49	121	0
	D	Full Orchestra	8	0	1	49	95	12
3	A	Small Str. Ens	9	0	1	49	95	13
	B	Quartet	10	0	1	49	95	11
	C	Str. Bass Ens.	11	0	1	44	121	0
	D	Str. Sustain	12	0	1	49	95	10
4	A	Pizzicato	13	0	1	46	121	0
	B	TremoloStrings	14	0	1	45	121	0
	C	Str. Sforzando	15	0	1	49	95	9
	D	Orchestra Hit	16	0	1	56	121	0

			Multi Timbre ON1			Multi Timbre ON2		
			Prog#	Bank MSB	Bank LSB	Prog#	Bank MSB	Bank LSB
5	A	Passionate Vln	17	0	1	41	121	0
	B	Classic Violin	18	0	1	41	95	3
	C	Passionate Vc	19	0	1	43	121	0
	D	Classic Cello	20	0	1	43	95	4
6	A	Choir	21	0	1	53	121	0
	B	Breathy Choir	22	0	1	53	95	1
	C	Choir Aahs	23	0	1	53	95	3
	D	Slow Choir	24	0	1	53	95	2
7	A	Jazz Ensemble	25	0	1	54	95	2
	B	Female Scat	26	0	1	54	95	22
	C	Pop Ensemble	27	0	1	54	121	0
	D	Contemp Ens.	28	0	1	54	95	10
8	A	Itopia	29	0	1	92	121	0
	B	Halo Pad	30	0	1	95	121	0
	C	Halo Pad 2	31	0	1	95	95	1
	D	Synth Vocals	32	0	1	55	121	0
Brass/Wind								
1	A	Exp Brass	33	0	1	62	95	8
	B	Exp Saxes	34	0	1	66	95	11
	C	Tp&Bone&Tenor	35	0	1	58	95	11
	D	Flugel & Tenor	36	0	1	57	95	18
2	A	Brass Section	37	0	1	62	121	0
	B	Synth Brass	39	0	1	63	121	0
	C	Synth Brass 2	40	0	1	64	121	0
	D	Jump Brass	38	0	1	63	121	3
3	A	Exp Trumpet	41	0	1	57	121	0
	B	Plunger Trumpet	42	0	1	57	95	7
	C	Trumpet Shake	44	0	1	57	95	6
	D	Harmon Mute Tp	43	0	1	60	121	0
4	A	Exp Trombone	45	0	1	58	121	0
	B	Lead Trombone	46	0	1	58	95	2
	C	Plunger Trombon	47	0	1	58	95	4
	D	ClosedMuteBone	48	0	1	58	95	9
5	A	Exp Alto	49	0	1	66	121	0
	B	Lead Alto	50	0	1	66	95	2
	C	Soft Alto	51	0	1	66	95	7
	D	Lead Soprano	52	0	1	65	121	0
6	A	Exp Tenor	53	0	1	67	121	0
	B	Ballad Tenor	54	0	1	67	95	6
	C	Growl Tenor	55	0	1	67	95	4
	D	Baritone Sax	56	0	1	68	121	0
7	A	Exp Flute	57	0	1	74	95	12
	B	Ballad Flute	58	0	1	74	121	0
	C	Flute Overblow	59	0	1	74	95	9
	D	Flute Flutter	60	0	1	74	95	10
8	A	Oboe	61	0	1	69	121	0
	B	Bassoon	62	0	1	71	121	0
	C	Jazz Clarinet	63	0	1	72	121	0
	D	Pan Flute	64	0	1	76	121	0

			Multi Timbre ON1			Multi Timbre ON2		
			Bank	Bank		Bank	Bank	
			Prog#	MSB	LSB	Prog#	MSB	LSB
Pad & Synth								
1	A	New Age Pad	65	0	1	89	121	0
	B	New Age Pad 2	66	0	1	89	95	1
	C	New Age Pad 3	67	0	1	89	95	2
	D	New Age Pad 4	68	0	1	89	95	3
2	A	Atmosphere	69	0	1	100	121	0
	B	Brightness	70	0	1	101	121	0
	C	Brightness 2	71	0	1	101	95	1
	D	Goblin	72	0	1	102	121	0
3	A	Classic Synth	73	0	1	82	121	0
	B	Classic Synth2	74	0	1	82	121	1
	C	Big Saw	75	0	1	82	95	1
	D	Saw Pad	76	0	1	82	95	3
4	A	Pulse Lead	77	0	1	82	95	4
	B	Pulse Lead 2	78	0	1	82	95	5
	C	Square Lead	79	0	1	81	121	0
	D	Lead	80	0	1	82	121	2
5	A	Caliope	81	0	1	83	121	0
	B	Chiff	82	0	1	84	121	0
	C	Ensemble Lead	83	0	1	84	95	1
	D	Blow lead	84	0	1	83	95	2
6	A	Bright WarmPad	85	0	1	90	95	1
	B	Warm Pad	86	0	1	90	121	0
	C	Sine Pad	87	0	1	90	121	1
	D	Bowed Pad	88	0	1	93	121	0
7	A	Brass Pad	89	0	1	62	95	2
	B	Metallic	90	0	1	94	121	0
	C	Multi Sweep	91	0	1	96	121	0
	D	Soundtrack	92	0	1	98	121	0
8	A	Analog Brass	93	0	1	63	121	2
	B	Analog Brass 2	94	0	1	64	121	2
	C	Analog Brass 3	95	0	1	64	95	1
	D	Analog Brass 4	96	0	1	64	95	2
Bass/Guitar								
1	A	Acc. Bass	97	0	1	33	121	0
	B	Acc. Bass&Ride	98	0	1	33	95	1
	C	Electric Bass	99	0	1	34	95	1
	D	Electric Bass2	100	0	1	34	95	4
2	A	Finger Bass	101	0	1	34	121	0
	B	FingerSlapBass	102	0	1	34	121	1
	C	Pick Bass	103	0	1	35	121	0
	D	Fretless Bass	104	0	1	36	121	0
3	A	Synth Bass	105	0	1	39	121	0
	B	Synth Bass 2	106	0	1	40	121	0
	C	Rubber Bass	107	0	1	40	121	2
	D	Warm SynthBass	108	0	1	39	121	1
4	A	Exp. Nylon Gtr	109	0	1	25	121	0
	B	Pick Nylon Gtr	110	0	1	25	95	3
	C	Exp Guitar	111	0	1	26	121	0
	D	Exp Guitar 2	112	0	1	26	95	11

			Multi Timbre ON1			Multi Timbre ON2		
			Bank	Bank				
			MSB	LSB	Bank	Bank	Bank	
			Prog#		Prog#	MSB	LSB	
5	A	Rhythm Guitar	113	0	1	28	121	0
	B	Overdrive	114	0	1	30	121	0
	C	Distortion	115	0	1	31	121	0
	D	Muted Electric	116	0	1	29	121	0
6	A	Pedal Steel	117	0	1	27	121	1
	B	Hawaiian Guitar	118	0	1	27	95	1
	C	Jazz Guitar	119	0	1	27	121	0
	D	Jazz Guitar 2	120	0	1	27	95	2
7	A	Banjo	121	0	1	106	121	0
	B	Mandolin	122	0	1	26	121	2
	C	Sitar	123	0	1	105	121	0
	D	Harp	124	0	1	47	121	0
8	A	Standard Set	125	0	1	1	120	0
	B	Standard Set 2	126	0	1	33	120	0
	C	Room Set	127	0	1	9	120	0
	D	Analog Set	128	0	1	26	120	0

9.4 Notes about USB

The MP8 can be connected with a personal computer with a USB cable for exchanging MIDI data. You need a USB driver installed in your computer.

[For Windows XP/Me users]

A standard USB driver is already installed in your computer. You don't need to install a new driver.

[For Windows 2000/98SE users]

You need to install the designated driver in your computer. Visit the KAWAI web site at <http://www.kawai.co.jp/english/Download1.htm> and download the program.

[For Macintosh users]

Macintosh OSX automatically recognizes our USB interface. No special driver is needed. Older Macintosh OS are not supported by us. If you have an older Macintosh OS, please use an appropriate MIDI interface and MIDI cables when connecting the MP8 to a Macintosh computer.

NOTE:

When both MIDI jacks and USB jack are connected, USB has priority.

When connecting USB cable to the MP8, first connect the USB cable and then turn the power of the MP8 on. It may take some time to start communication when the MP8 is connected to the computer via USB.

When USB communication is unstable with connection via hub, connect the USB cable directly to the USB port of the computer.

Turning the power of MP8 on/off or disconnecting the USB cable while the following actions may cause unstable communication.

- while installing USB driver
- while booting up the computer
- while MIDI application is working
- while communicating with the computer
- while the computer is in energy saver mode

* If you have any problem with USB communication, consult the instruction manual of your computer and check your computer set up.

* The USB-MIDI conversion board TID10000934 used in the MP8 is approved to show the USB logo. The USB logo can be used only for the product which is approved by USB-IF (USB Implements Forum Inc.) test.

* Windows is registered trademark of Microsoft Corporation.

* Macintosh is registered trademark of Apple Computer, Inc.

Specifications

Keyboard	88 Wooden keys with AWA Grand PRO
# of Zone	4 zones
# of Internal Sound	256 sounds
Polyphony	Maximum 192
Effect	7 Reverbs, 20 Effects, 4-band Equalizer
Internal Memory	256 SETUPS
Display	16 x 2 LCD w/backlight
Jack	1/4" Out (L/MONO, R), XLR Out (L, R), Headphones, MIDI IN/ OUT/THRU, USB, Damper/Soft Pedal, FSW, EXP, AC Inlet
Dimensions (WxDxH)	1466 x 442 x 189 mm (57 3/4" x 17 1/2" x 7 1/2")
Weight	32 kg (70.5 lbs)
Accessories included	Music Rack, Power Cable, Damper Pedal (F-20), Owner's Manual

* Specifications subject to change without notice.

MP8 MIDI Implementation

Version 1.0 August 2005

Contents

1. Recognized data
 - 1.1 Channel Voice Message
 - 1.2 Channel Mode Message
 - 1.3 System Real time Message
2. Transmitted data
 - 2.1 Channel Voice Message
 - 2.2 Channel Mode Message
 - 2.3 System Real time Message
3. Exclusive data
 - 3.1 Universal Realtime Exclusive Message
 - 3.2 Damp Message
 - 3.3 Setup Data Format
4. Table
 - 4.1 CC# table

MIDI Implementation Chart

1. Recognized Data

1.1 Channel Voice message

Note off

Status	2nd Byte	3rd Byte	
8nH	kkH	vvH	
9nH	kkH	00H	
n=MIDI channel number			:0H-fH(ch.1 - ch.16)
kk=Note Number			:00H - 7fH(0 - 127)
vv=Velocity			:00H - 7fH(0 - 127)

Note on

Status	2nd Byte	3rd Byte	
9nH	kkH	vvH	
n=MIDI channel number			:0H-fH(ch.1 - ch.16)
kk=Note Number			:00H - 7fH(0 - 127)
vv=Velocity			:00H - 7fH(0 - 127)

Control Change

Bank Select (MSB)

Status	2nd Byte	3rd Byte	
BnH	00H	mmH	
BnH	20H	llH	
n=MIDI channel number			:0H-fH(ch.1 - ch.16)
mm = Bank Number MSB			00H-7fH (0-127)
ll = BankNumber LSB			00H-7fH (0-127)

Modulation

Status	2nd Byte	3rd Byte	
BnH	01H	vvH	
n=MIDI channel number			:0H-fH(ch.1 - ch.16)
vv = Modulation depth			:00H - 7fH(0 - 127) Default = 00H

Data Entry

Status	2nd Byte	3rd Byte	
BnH	06H	mmH	
BnH	26H	llH	
n=MIDI channel number			:0H-fH(ch.1 - ch.16)
mm,ll=Value indicated in RPN/NRPN, see RPN/NRPN chapter			:00H - 7fH(0 - 127)

Volume

Status	2nd Byte	3rd Byte	
BnH	07H	vvH	
n=MIDI channel number			:0H-fH(ch.1 - ch.16)
vv = Volume			:00H - 7fH(0 - 127) Default = 7fH

Panpot

Status	2nd Byte	3rd Byte	
BnH	0aH	vvH	
n=MIDI channel number			:0H-fH(ch.1 - ch.16)
vv = Panpot			:00H - 40H - 7fH(left - Center - right) Default = 40H(center)

Expression

Status	2nd Byte	3rd Byte	
BnH	0bH	vvH	
n=MIDI channel number			:0H-fH(ch.1 - ch.16)
vv = Expression			:00H - 7fH(0 - 127) Default = 7fH

Damper Pedal

Status	2nd Byte	3rd Byte	
BnH	40H	vvH	
n=MIDI channel number		:0H-fH(ch.1 - ch.16)	
vv = Control Value		:00H - 7fH(0 - 127)	Default = 00H
		0 - 63 =OFF, 64 - 127=ON	

Sostenuto Pedal

Status	2nd Byte	3rd Byte	
BnH	42H	vvH	
n=MIDI channel number		:0H-fH(ch.1 - ch.16)	
vv = Control Value		:00H - 7fH(0 - 127)	Default = 00H
		0 - 63 =OFF, 64 - 127=ON	

Soft Pedal

Status	2nd Byte	3rd Byte	
BnH	43H	vvH	
n=MIDI channel number		:0H-fH(ch.1 - ch.16)	
vv = Control Value		:00H - 7fH(0 - 127)	Default = 00H
		0 - 63 =OFF, 64 - 127=ON	

Sound controllers #1-9

Status	2nd Byte	3rd Byte	
BnH	46H	vvH	Sustain Level
BnH	47H	vvH	Resonance
BnH	48H	vvH	Release time
BnH	49H	vvH	Attack time
BnH	4aH	vvH	Cutoff
BnH	4bH	vvH	Decay time
BnH	4cH	vvH	Vibrato Rate
BnH	4dH	vvH	Vibrato Depth
BnH	4eH	vvH	Vibrato Delay
n=MIDI channel number		:0H-fH(ch.1 - ch.16)	
vv = Control Value		:00H - 7fH(-64 - 0 - +63)	Default = 40H

Effect Control

Status	2nd Byte	3rd Byte	
BnH	5bH	vvH	Reverb depth
BnH	5cH	vvH	Rotary speaker speed(0-63:Slow,64-127:Fast)
			*Only when rotary speaker selected
BnH	5dH	vvH	Chorus depth
BnH	5eH	vvH	Effect death
n=MIDI channel number		:0H-fH(ch.1 - ch.16)	
vv = Control Value		:00H - 7fH(0 - 127)	

NRPN MSB/LSB

Status	2nd Byte	3rd Byte	
BnH	63H	mmH	
BnH	62H	llH	
n=MIDI channel number		:0H-fH(ch.1 - ch.16)	
mm=MSB of the NRPN parameter number			
ll=LSB of the NRPN parameter number			

NRPN numbers implemented in MP8 are as follows

NRPN #	Data	Function & Range	Default
01H 08H	mmH	Vibrato Rate mm:00H - 7FH(-64 - 0 - +63)	Default = 40H
01H 09H	mmH	Vibrato Depth mm:00H - 7FH(-64 - 0 - +63)	Default = 40H
01H 0aH	mmH	Vibrato Delay mm:00H - 7FH(-64 - 0 - +63)	Default = 40H
01H 20H	mmH	Cutoff mm:00H - 7FH(-64 - 0 - +63)	Default = 40H
01H 21H	mmH	Resonance mm:00H - 7FH(-64 - 0 - +63)	Default = 40H
01H 63H	mmH	Attack time mm:00H - 7FH(-64 - 0 - +63)	Default = 40H

01H 64H	mmH	Decay time	mm:00H - 7FH(-64 - 0 - +63)	Default = 40H
01H 66H	mmH	Release time	mm:00H - 7FH(-64 - 0 - +63)	Default = 40H

* Ignoring the LSB of data Entry
 * It is not affected in case of modifying cutoff if tone does not use the dcf.

RPN MSB/LSB

Status	2nd Byte	3rd Byte
BnH	65H	mmH
BnH	64H	llH

n=MIDI channel number :0H-fH(ch.1 - ch.16)
 mm=MSB of the RPN parameter number
 ll=LSB of the RPN parameter number

RPN number implemented in MP8 are the followings

RPN #	Data
MSB LSB	MSB Function & Range
00H 00H	mmH Pitch bend sensitivity mm:00H-0cH(0-12 half tone) Default=02H ll:00H
00H 01H	mmH Master fine tuning mm,ll:20 00H - 40 00H - 60 00 (-8192x50/8192 - 0 +8192x50/8192 cent)
00H 00H	mmH Pitch bend sensitivity mm:00H - 07H(0 - 7 half tone) Default = 02H ll:Ignored(as 00H)
00H 01H	mmH Master fine tuning mm,ll:00 00H - 40 00H - 7f 7f (-8192x100/8192 - 0 +8192x100/8192 cent)
00H 02H	mmH Master coarse tuning mm:28H - 40H - 58H(-24 - 0 - +24 half tone) ll:Ignored(as 00H)
7fH 7fH	-- RPN NULL

Program Change

Status	2nd Byte
CnH	ppH

n=MIDI channel number :0H-fH(ch.1 - ch.16)
 pp=Program number :00H - 7fH(0 - 127) Default = 00H

Pitch Bend Change

Status	2nd Byte	3rd Byte
EnH	llH	mmH

n=MIDI channel number :0H-fH(ch.1 - ch.16)
 mm,ll=Pitch bend value :00 00 - 7f 7fH(-8192 - 0 - +8192) Default = 40 00H(center)

1.2 Channel Mode Message

All Sound OFF

Status	2nd Byte	3rd Byte
BnH	78H	00H

n=MIDI channel number :0H-fH(ch.1 - ch.16)

Reset All Controller

Status	2nd Byte	3rd Byte
BnH	79H	00H

n=MIDI channel number :0H-fH(ch.1 - ch.16)

All Note Off

Status	2nd Byte	3rd Byte
BnH	7bH	00H

n=MIDI channel number :0H-fH(ch.1 - ch.16)

MONO

Status	2nd Byte	3rd Byte
BnH	7eH	mmH

n=MIDI channel number :0H-fH(ch.1 - ch.16)

mm=mono number :01H(M=1)

POLY

Status	2nd Byte	3rd Byte
BnH	7fH	00H

n=MIDI channel number :0H-fH(ch.1 - ch.16)

1.3 System Realtime Message

Status	
FEH	Active sensing

2. Transmitted Data

2.1 Channel Voice Message

Note off

Status	2nd Byte	3rd Byte
9nH	kkH	00H

n=MIDI channel number :0H-fH(ch.1 - ch.16)

kk=Note Number :00H - 7fH(0 - 127)

Note on

Status	2nd Byte	3rd Byte
9nH	kkH	vvH

n=MIDI channel number :0H-fH(ch.1 - ch.16)

kk=Note Number :00H - 7fH(0 - 127)

vv=Velocity :00H - 7fH(0 - 127)

Control Change

Bank Select

Status	2nd Byte	3rd Byte
BnH	00H	mmH
BnH	20H	llH

n=MIDI channel number :0H-fH(ch.1 - ch.16)

mm=Bank Number MSB :00H - 7fH(0 - 127)

ll=Bank Number LSB :00H - 7fH(0 - 127)

Modulation

Status	2nd Byte	3rd Byte
BnH	01H	vvH

n=MIDI channel number		:0H-fH(ch.1 - ch.16)	
vv = Modulation depth		:00H - 7fH(0 - 127)	
Data Entry			
Status	2nd Byte	3rd Byte	
BnH	06H	mmH	
BnH	26H	llH	
n=MIDI channel number		:0H-fH(ch.1 - ch.16)	
mm,ll=Value indicated in RPN/NRPN, see RPN/NRPN chapter		:00H - 7fH(0 - 127)	
Volume			
Status	2nd Byte	3rd Byte	
BnH	07H	vvH	
n=MIDI channel number		:0H-fH(ch.1 - ch.16)	
vv = Volume		:00H - 7fH(0 - 127)	Default = 64H
Panpot			
Status	2nd Byte	3rd Byte	
BnH	0aH	vvH	
n=MIDI channel number		:0H-fH(ch.1 - ch.16)	
vv = Panpot		:00H - 7fH(0 - 127)	Default = 40H(center)
Expression			
Status	2nd Byte	3rd Byte	
BnH	0bH	vvH	
n=MIDI channel number		:0H-fH(ch.1 - ch.16)	
vv = Expression		:00H - 7fH(0 - 127)	Default = 7fH
Damper Pedal			
Status	2nd Byte	3rd Byte	
BnH	40H	vvH	
n=MIDI channel number		:0H-fH(ch.1 - ch.16)	
vv = Control Value		:00H - 7fH(0 - 127) 0 - 63 =OFF, 64 - 127=ON	Default = 00H
Sostenuto Pedal			
Status	2nd Byte	3rd Byte	
BnH	42H	vvH	
n=MIDI channel number		:0H-fH(ch.1 - ch.16)	
vv = Control Value		:00H - 7fH(0 - 127)	Default = 00H
Soft Pedal			
Status	2nd Byte	3rd Byte	
BnH	43H	vvH	
n=MIDI channel number		:0H-fH(ch.1 - ch.16)	
vv = Control Value		:00H - 7fH(0 - 127) 0 - 63 =OFF, 64 - 127=ON	Default = 00H
Sound controllers #1-9			
Status	2nd Byte	3rd Byte	
BnH	46H	vvH	Sustain Level
BnH	47H	vvH	Resonance
BnH	48H	vvH	Release time
BnH	49H	vvH	Attack time
BnH	4aH	vvH	Cutoff
BnH	4bH	vvH	Decay time
BnH	4cH	vvH	Vibrato Rate
BnH	4dH	vvH	Vibrato Depth
BnH	4eH	vvH	Vibrato Delay
n=MIDI channel number		:0H-fH(ch.1 - ch.16)	
vv = Control Value		:00H - 7fH(-64 - 0 - +63)	Default = 40H

Effect Control

Status	2nd Byte	3rd Byte	
BnH	5bH	vvH	Reverb depth
BnH	5cH	vvH	Rotary speaker speed(0-63:Slow,64-127:Fast) *Only when rotary speaker selected
BnH	5dH	vvH	Chorus depth
BnH	5eH	vvH	Effect death
n=MIDI channel number		:0H-fH(ch.1 - ch.16)	
vv = Control Value		:00H - 7fH(0 - 127)	

RPN MSB/LSB

Status	2nd Byte	3rd Byte	
BnH	65H	mmH	
BnH	64H	llH	
n=MIDI channel number		:0H-fH(ch.1-ch.16)	
mm=MSB of the RPN parameter number			
ll=LSB of the RPN parameter number			

RPN number implemented in MP8 are the followings

RPN #	Data	Function & Range	Default=02H
MSB LSB	MSB	Pitch bend sensitivity	
00H 00H	mmH	mm:00H-0cH(0-12 half tone)	ll:00H
00H 01H	mmH	Master fine tuning	
		mm,ll:20 00H - 40 00H - 60 00 (-8192x50/8192 - 0 +8192x50/8192 cent)	
7fH 7fH	--	RPN NULL	

Program Change

Status	2nd Byte		
CnH	ppH		
n=MIDI channel number		:0H-fH(ch.1 - ch.16)	
pp=Program number		:00H - 7fH	Default = 00H

After Touch

Status	2nd Byte		
DnH	ppH		
n=MIDI channel number		:0H-fH(ch.1 - ch.16)	
pp=Value		:00H - 7fH	Default = 00H
*Sending only when EXP CC#=AFT			

Pitch Bend Change

Status	2nd Byte	3rd Byte	
EnH	llH	mmH	
n=MIDI channel number		:0H-fH(ch.1 - ch.16)	
mm,ll=Pitch bend value		:00 00 - 7f 7fH(-8192 - 0 - +8192)	Default = 40 00H(center)

2.2 Channel Mode Message

MONO

Status	2nd Byte	3rd Byte	
BnH	7eH	mmH	
n=MIDI channel number		:0H-fH(ch.1 - ch.16)	
mm=mono number		:01H(M=1)	

POLY

Status	2nd Byte	3rd Byte	
BnH	7fH	00H	
n=MIDI channel number		:0H-fH(ch.1 - ch.16)	

2.3 System Realtime Message

Status

F8H Clock
 FAH Start
 FCH Stop

*Sending [SW] External Seq. Start/Stop

3. Exclusive Data

3.1 Universal Realtime Exclusive Message

Master Volume

Format :F0 7F 7F 04 01 ll mm F7

mm=MSB of Master Volume

ll=LSB of Master Volume

3.2 MP8 Dump Message

MP8 can receive these dump data, and also can transmit by the panel operation with System switch.

Also,MP8 can receive MP4/9500/9000's dump data.(Please see the manual of MP4/9500/9000 about the format.)

*note: Part of MP9000/95000's tone or parameters is replaced to the MP8's one.

a: MP8 Dump CURRENT

Format :F0 40 <ch> 20 00 0E <DATA> F7

<ch> :MIDI ch (00~0F)

<DATA> :432bytes *Current Setup data in edit buffer or to edit buffer

b: MP8 Dump ALL(Setup 1-64)

Format :F0 40 <ch> 21 00 0E <DATA> F7

<ch> :MIDI ch (00~0F)

<DATA> :110,592bytes *All Setup 1~256 (Setup1-1-A ... Setup 8-8-D)

3.3 Setup Data Format

The structure of the one Setup patch [432bytes]

(common DATA) + (Zone 1,2,3,4 Int DATA) + (Zone 1,2,3,4 Ext DATA)

3.3.1 Common DATA

No.	PARAMETER	VALUE
1-2	-reserved-	
3-16	Name 1st~14th	ASCII
17	Zone Select	0-3 (0-3:Zone1-4)
18-21	Zone1-4 Edit Section	1,2 0(1:INT, 2:EXT)
22-25	Zone1-4 Mode	0,1,2(0:BOTH, 1:INT, 2:EXT)
26-29	Zone1-4 On/Off	0,1 (0:off, 1:on)
30	Knob Mode	0-3 (0:Effect, 1:EQ, 2:tone, 3:CC#)
31	EQ Lo	52~64~76 (-12~0~+12[dB])
32	EQ Mid Lo	52~64~76 (-12~0~+12[dB])
33	EQ Mid Hi	52~64~76 (-12~0~+12[dB])
34	EQ Hi	52~64~76 (-12~0~+12[dB])
35	-reserved-	
36	-reserved-	
37	Reverb Type	0~6 (see p.22)
38	Reverb Time	0-127
39-42	Zone1 MIDI CC# A-D	0-119
43-46	Zone2 MIDI CC# A-D	0-119
47-50	Zone3 MIDI CC# A-D	0-119
51-54	Zone4 MIDI CC# A-D	0-119

55	FSW CC#	0-120 (120:Function SW)
56	EXP CC#	0-120 (120:After Touch)
57	Transpose SW	0,1 (0:off, 1:on)
58	Transpose Value	40~64~88 (-24~0~+24)
59	Function SW Type	0-8 (see p.17)
60	Function SW	0,1 (0:off,1:on)
61	Stretch Tuning	0-4 (0:Off,1:On,2:Piano,3:On Wide,4:Piano Wide)
62	Temperament	0-7 (see p.36)
63	Key of Temperament	0-11(0:C,1:C#,~,9:A,10:Bb,11:B)
64-75	User C-B Tuning	14~64~114 (-50~0~+50[cent])
76	Master Volume	0-127
77-84	-undefined-	

3.3.2 Zone 1-4 Internal DATA

No.	PARAMETER	VALUE
1	Tone Number MSB	0-2
2	Tone Number LSB	0-127
3	Voicing	0-5 (0:Normal,1~2:Mellow1~2,3:Dynamic,4~5:Bright1~2)
4	-reserved-	
5	Damper Effect	0-10 (0: off, 1-10)
6	String resonance	0-10 (0: off, 1-10)
7-40	<Both Parameter>	*see 3.3.4
41	EFX Type	0-19 (See P. 21)
42	EFX Rate	0-127
43	-undefined-	

3.3.3 Zone 1-4 External DATA

No.	PARAMETER	VALUE
1	tx_ch	0-15 (1~16ch)
2	Program Number	0-127 (#001-#128)
3	Bank Number LSB	0-127
4	Bank Number MSB	0-127
5	Prog# TX SW	0,1 (0:off,1:on)
6	Bank# TX SW	0,1 (0:off,1:on)
7	Volume TX SW	0,1 (0:off,1:on)
8	MIDI CC# TX SW	0,1 (0:off,1:on)
9	BendRange TX SW	0,1 (0:off,1:on)
10-43	<Both Parameter>	*see 3.3.4
44	-undefined-	

3.3.4 Zone 1-4 Both Parameters

No.	PARAMETER	VALUE
1	Section On/Off	0,1 (off,on)
2-3	KeyRange Lo/Hi	0-127 (A0~C8)
4	VeloSW Type	0~2(off,loud,soft)
5	VeloSW Value	0~127
6	Velo Comp	1~64~127 (-63~0~+63)
7	Solo SW	0,1 (off,on)
8	Solo Mosw	0,1,2 (Last,Hi,Lo)
9	Zone Transpose	40~64~88 (-24~0~+24)
10	Effect SW	0,1 (off,on)
11	Reverb SW	0,1 (off,on)
12	Damper SW	0,1 (off,on)
13	FSW SW	0,1 (off,on)
14	EXP SW	0,1 (off,on)
15	Modulation SW	0,1 (off,on)
16	Bender SW	0,1 (off,on)
17	Volume	0-127
18	Panpot	1-64-127 (L63~0~R63)
19	Reverb Depth	0-127
20	Effect Depth	0-127
21	Bend Range	<INT>0-7 <EXT>0-12

22	-reserverd-	
23	Fine Tune	1-64-127 (-50*63/63~0~+50*63/63[cent])
24	Cutoff	14~64~114(-50~0~+50)
25	Attack Time	14~64~114(-50~0~+50)
26	Decay Time	14~64~114(-50~0~+50)
27	Release Time	14~64~114(-50~0~+50)
28	CC# A Value	0-127
29	CC# B Value	0-127
30	CC# C Value	0-127
31	CC# D Value	0-127
32	Velo Offset	0-127
33-34	-undefined-	

4. Control Change Number (CC#) Table

Control Number		Control Function
Decimal	Hex	
0	0	Bank Select (MSB)
1	1	Modulation Wheel or lever
2	2	Breath Controller
3	3	(undefined)
4	4	Foot Controller
5	5	Portament Time
6	6	Data Entry (MSB)
7	7	Channel Volume
8	8	Balance
9	9	(undefined)
10	A	Panpot
11	B	Expression Controller
12	C	Effect Controller1
13	D	Effect Controller2
14	E	(undefined)
15	F	(undefined)
16-19	10-13	General Purpose Controller1~4
20-31	14-1F	(undeifined)
32	20	Bank Select (LSB)
33-63	21-3F	(LSB of Control Number 1-32)
64	40	Hold1 (Damper Pedal or Sustain)
65	41	Poratament On/Off
66	42	Sostenuto
67	43	Soft Pedal
68	44	Legato Footswitch
69	45	Hold2 (freez etc)
70	46	Sound Controller1 (Sound Variation)
71	47	Sound Controller2 (Filter Resonance/Harmonic Intensity)
72	48	Sound Controller3 (Release Time)
73	49	Sound Controller4 (Attack Time)
74	4A	Sound Controller5 (Brightness/Cutoff)
75	4B	Sound Controller6 (Decay Time)
76	4C	Sound Controller7 (Vibrato Rate)
77	4D	Sound Controller8 (Vibrato Depth)
78	4E	Sound Controller9 (Vibrato Delay)
79	4F	Sound Controller10
80-83	50-53	General Purpose Controller5~8
84	54	Portament Control
85-90	55-5A	(undefine)
91	5B	Effect1 Depth (Reverb Send Level)
92	5C	Effect2 Depth
93	5D	Effect3 Depth (Chorus Send Level)
94	5E	Effect4 Depth
95	5F	Effect5 Depth
96	60	Data Increment
97	61	Data Decrement
98	62	Non Registered Parameter Number (LSB)
99	63	Non Registered Parameter Number (MSB)
100	64	Registered Parameter Number (LSB)
101	65	Registered Parameter Number (MSB)
102-119	66-77	(undefined/reserved)
120-127	78-7F	Channel Mode Message

MIDI Implementation Chart

[STAGE PIANO]
Model: KAWAI MP8

Date: Augst 2005
Version: 1.0

Function		Transmit	Receive		Remarks
			Multi Off	Multi On	
Basic Channel	Default	1-16	1-16	1-16	
	Changed	1-16	1-16	1-16	
Mode	Default	3	3	3	
	Messages	3, 4 (M=1)	X	3, 4 (M=1)	
	Altered	*****			
Note Number:	True Voice	0-127 *****	0-127	0-127	
Velocity	Note ON	○ 1-127	○ 1-127	○ 1-127	
	Note OFF	X	X	X	
After Touch	Key's	X	X	X	
	Ch's	○ (*1)	X	X	
Pitch Bend		○	○	○	
Control Change	0, 32	○	○	○	Bank Select
	1	○	○ (*2)	○	Modulation
	6, 38	○	X	○	Data Entry
	7	○	○ (*3)	○	Volume
	10	○	X	○	Panpot
	11	○	○ (*2, 4)	○	Expression (EXP)
	64	○	○ (*2)	○	Hold1 (Damper)
	66	○	○ (*2, 4)	○	Sostenuto (FSW)
	67	○	○	○	Soft
	70, 71	○	X	○	Sustain, Resonance
	72, 73, 74, 75	○	X	○	RLS, ATK, CTF, DCY
	76, 77, 78	○	X	○	Vibrato (Rate, Depth, Delay)
	91	○	X	○	Reverb Depth
	92	○	○ (*5)	○ (*5)	Rotary Speed
	93	○	X	○	Chorus Depth
	94	○	○	○	Effect Depth
98, 99	○	X	○	NRPN LSB/MSB	
100, 101	○	X	○	RPN LSB/MSB	
0-119	○ (*1)	X	X		
Prog Change:	True #	*****	0-127	0-63	
System Exclusive		○	○	○	
Common	: Song Position	X	X	X	
	: Song Select	X	X	X	
	: Tune	X	X	X	
System Real Time	: Clock	○	X	X	
	: Commands	○	X	X	
Aux Messages	: All Sound Off	X	○	○	
	: Reset All Controller	X	○	○	
	: Local ON/OFF X	X	X	X	
	: All Note OFF	X	○ (123-127)	○ (123-127)	
	: Active Sense	X	○	○	
	: Reset	X	X	X	
Notes		*1: assigned to EXP, FSW, Knob A-D *2: On/Off is set in Menu *3: Control the Master Volume of Common Parameter *4: The effect is assigned to EXP/FSW in Menu (default effect is Expression/Sostenuto) *5: Only when rotary effect is selected			

"Mode1: OMNI ON, POLY"
"Mode3: OMNI OFF, POLY"

"Mode2: OMNI ON, MONO"
"Mode4: OMNI OFF, MONO"

O: Yes
X: No

KAWAI



on 100% recycled paper

MP8 Owner's Manual
OW985E-C0508
Printed in Indonesia

Eng

Free Manuals Download Website

<http://myh66.com>

<http://usermanuals.us>

<http://www.somanuals.com>

<http://www.4manuals.cc>

<http://www.manual-lib.com>

<http://www.404manual.com>

<http://www.luxmanual.com>

<http://aubethermostatmanual.com>

Golf course search by state

<http://golfingnear.com>

Email search by domain

<http://emailbydomain.com>

Auto manuals search

<http://auto.somanuals.com>

TV manuals search

<http://tv.somanuals.com>