

KAWAI

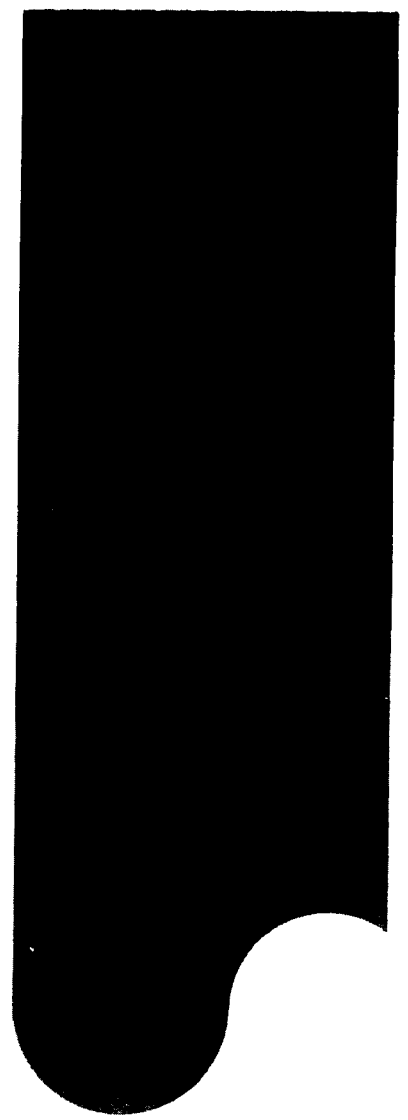

Owner's Manual **PV10**
DIGITAL PIANO **PV30**

TABLE OF CONTENTS

1. Digital Piano Familiarization	1
2. Playing Your Piano for the First Time	4
3. Adding RHYTHM	8
4. Let's Use the AUTO PLAY ACCOMPANIMENT	11
5. Recording Your Sound in SEQUENCER (PV30)	13
6. Using RAM Card (PV30)	21
7. MIDI	24
8. Other Functions	32
Chord Table	34
PV10/30 Specifications	36

1. Digital Piano Familiarization

■ PV30 FRONT PANEL

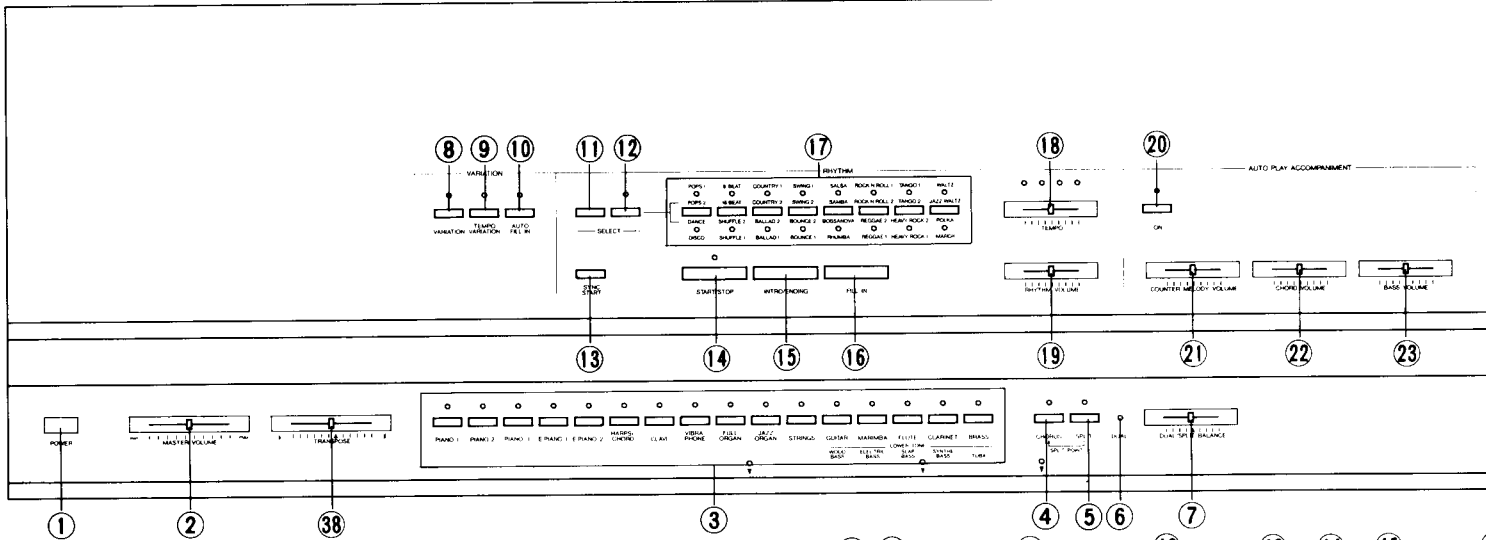

■ PV 30 REAR PANEL

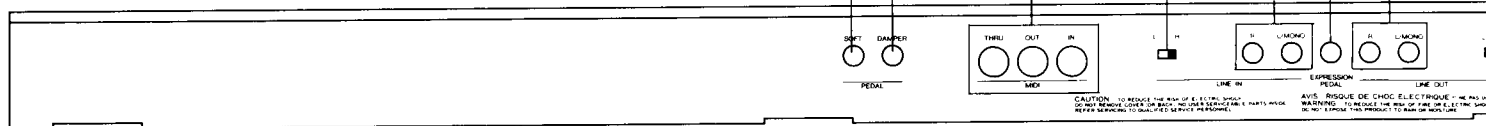

■ PV10 FRONT PANEL

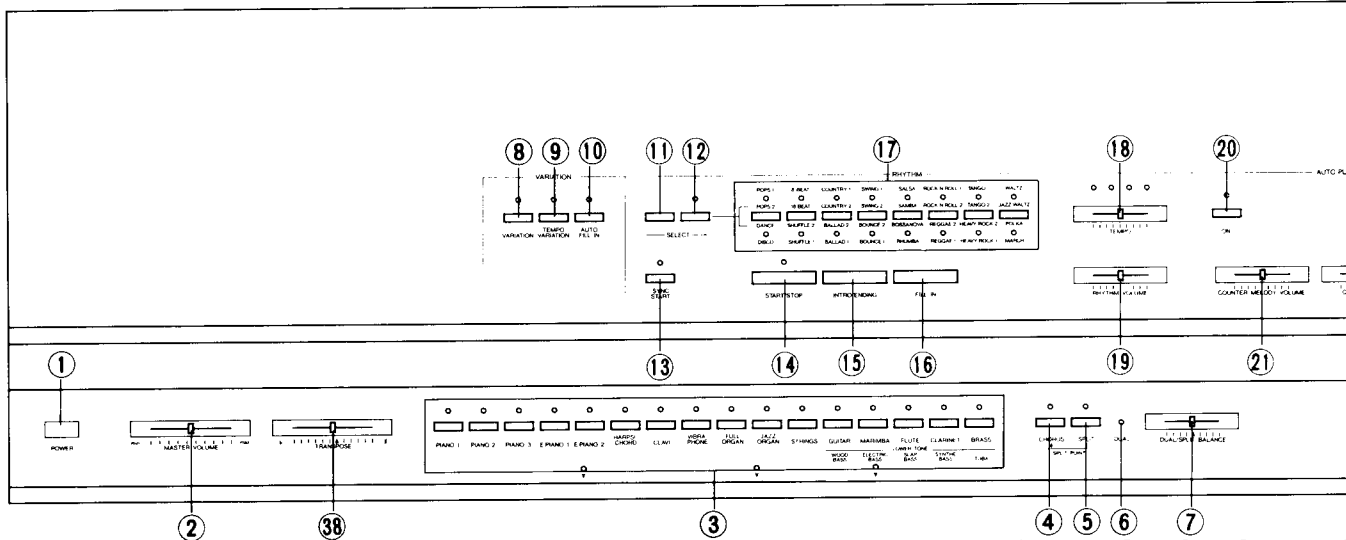

■ PV10 REAR PANEL

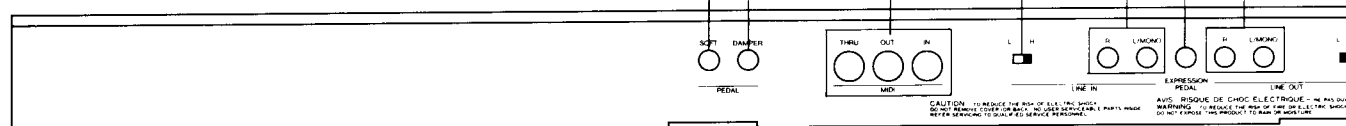

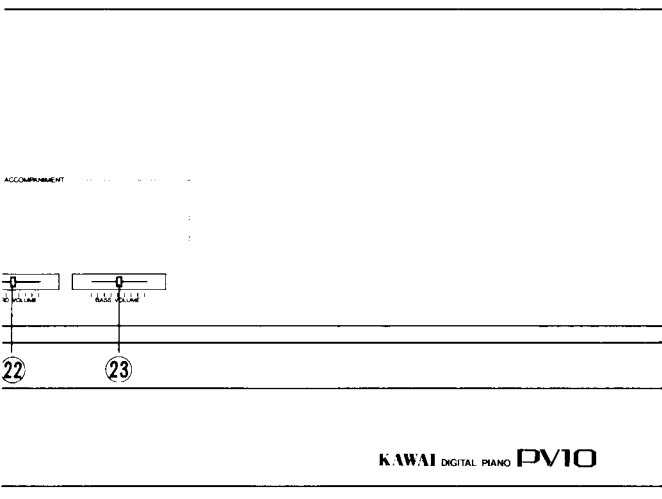
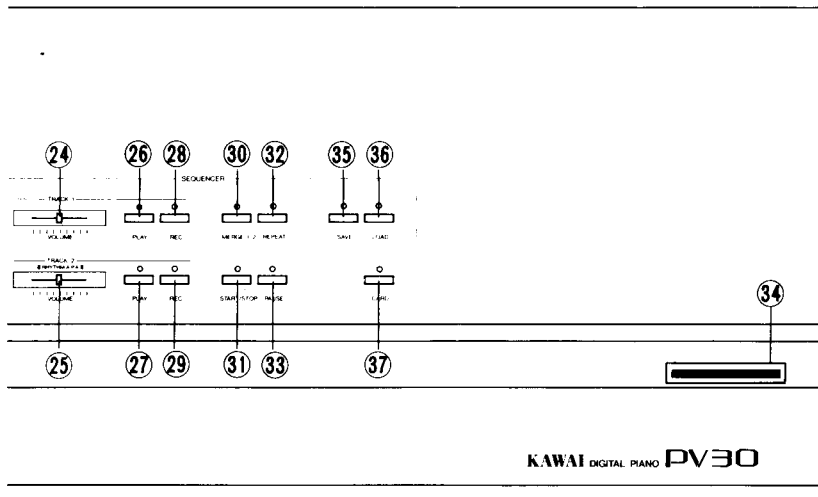

(Refer to CHAPTER 2, "Playing Your Piano for the First Time".)

① POWER switch

Turns the power on and off to the Digital Piano. Always turn off the power when you don't plan to play the Digital Piano for a long period of time.

2 MASTER VOLUME slide control

This is used to control the sound output volume of the Digital Piano.

③ Tone selector switches

These switches select the tone you prefer (instrument sound). When you press a switch, its LED indicator lights up and the tone is chosen.

④ CHORUS switch

This switch provides the CHORUS effect, making the sounds more animated.

⑤ SPLIT switch

This switch divides the keyboard into two sections. You can enjoy playing two different tones on your Digital Piano using this function. In combination with the CHORUS switch, this switch is also used to change the SPLIT POINT.

⑥ DUAL indicator

When two tone selector switches are pressed at the same time, the DUAL LED indicator lights, striking a single key creates two different tones.

⑦ DUAL/SPLIT BALANCE slide control

This is used to adjust the sound volume balance in DUAL or SPLIT mode playing.

(Refer to CHAPTER 3 "Adding RHYTHM".)

⑧ VARIATION switch

This switch allows you to add variations to RHYTHM patterns, and AUTO PLAY ACCOMPANIMENT.

⑨ TEMPO VARIATION switch

The RHYTHM and AUTO PLAY ACCOMPANIMENT chosen is varied according to the tempo you set.

⑩ AUTO FILL IN switch

FILL IN effect is automatically inserted every four bars.

⑪ SELECT switch

This switch selects the RHYTHM pattern; it selects between the upper set or lower set of RHYTHM patterns.

⑫ SELECT switch

This switch selects between outer or inner RHYTHM pattern pairs. When the LED is lit, the inner RHYTHM pattern is selected.

⑬ SYNC START switch

The selected RHYTHM and AUTO PLAY ACCOMPANIMENT start at the same time you strike a key.

⑭ START/STOP switch

The selected RHYTHM starts when this switch is pressed. Pressing this switch again stops the RHYTHM and AUTO PLAY ACCOMPANIMENT.

⑮ INTRO/ENDING switch

Using this switch, you can start the RHYTHM pattern and stop the RHYTHM pattern and AUTO PLAY ACCOMPANIMENT. In this case they begin in a set "intro" pattern and end in a set "finish" pattern.

IMPORTANT NOTES

● Power Supply

Use only the voltage appearing on the plate next to the power cord (Rear Panel). Incorrect voltage presents a shock hazard and will also damage the instrument's delicate electronic circuitry.

● Electrical Noise

Keep the instrument away from electrical motors, neon signs, fluorescent light fixtures, and other sources of electrical noise.

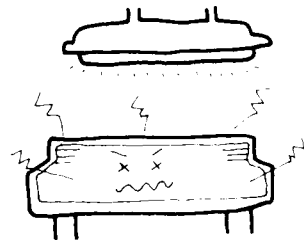

● Power Cord

Do not touch the power plug with wet hands. There is a risk of electrical shock.

Treat the power cord with care as well. Stepping on or tripping over it can break or short-circuit the wire inside.



● Repairs and Alterations

Never attempt to remove or modify the piano's circuitry. There is a significant shock hazard and there are no user servicable parts. If you think something is broken, consult your nearest authorized Kawai dealer.

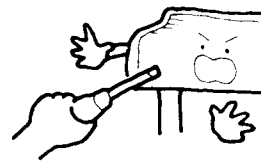

● After Use

Always turn the power off when the instrument is not in use. Leaving the piano on for extended periods can lead to serious problems.

This digital piano should be not commercial use but household use.

**Thank you for buying your new
KAWAI PV10/30 Digital Piano.
We welcome you to the family of
Kawai Digital Piano owners.**

The Kawai PV10/30 Digital Piano represents a new generation of keyboard instruments. Through Kawai's extensive knowledge of the acoustic piano and its harmonies, coupled with the latest electronic technology the Digital Piano has evolved.

Kawai has long been pursuing the natural feel of acoustic piano keys for electronic keyboards. The solution was found in our "Touch Response" technology, which allows a wide range of tone and sound volume changes, depending on how hard the keys are struck. With these capabilities, the Kawai Digital Piano offers the beginner the same responsive touch that it does the accomplished professional.

Automatic functions for RHYTHM and AUTO PLAY ACCOMPANIMENT along with memory function (PV30 only) using the SEQUENCER and a RAM card endow the Kawai PV10/30 Digital Piano with fabulous potential. It is truly an instrument which satisfies any level of keyboard enjoyment.

MIDI functions, included with the PV10/30, give this new generation digital piano an enriched capability, allowing it to communicate and work with many different digital musical instruments.

Please read this booklet carefully to learn all the ways of playing your new piano. Keep this booklet handy so that after you understand the basic functions of your Digital Piano, you can refresh your memory and expand your capabilities for many years of musical enjoyment.

16 FILL IN switch

This switch temporarily adds a variation to the RHYTHM pattern and AUTO PLAY ACCOMPANIMENT.

17 RHYTHM selector switches

You can select the desired RHYTHM with these switches. They are used in combination with the SELECT switches, mounted to the left of the RHYTHM selector switches.

18 TEMPO slide control

This is used to adjust the tempo of the RHYTHM and AUTO PLAY ACCOMPANIMENT.

19 RHYTHM VOLUME slide control

This is used to adjust RHYTHM volume.

(Refer to Chapter 4, "Let's Use the AUTO PLAY ACCOMPANIMENT".)

20 AUTO PLAY ACCOMPANIMENT ON

This switch is used to turn on and turn off the AUTO PLAY ACCOMPANIMENT function.

21 COUNTER MELODY VOLUME slide control

This is used to adjust COUNTER MELODY volume.

22 CHORD VOLUME slide control

This is used to adjust CHORD volume.

23 BASS VOLUME slide control

This is used to adjust BASS volume.

(See Chapter 5, "Recording Your Sound in SEQUENCER".)

24 TRACK 1 VOLUME slide control (PV30 only)

This is used to adjust recording/playback level for TRACK 1.

25 TRACK 2 VOLUME slide control (PV30 only)

This is used to adjust recording/playback level for TRACK 2.

26 TRACK 1 PLAY switch (PV30 only)

Press this switch to play back music recorded on TRACK 1.

27 TRACK 2 PLAY switch (PV30 only)

Press this switch to play back music recorded on TRACK 2.

28 TRACK 1 REC switch (PV30 only)

Press this switch to record music on TRACK 1.

29 TRACK 2 REC switch (PV30 only)

Press this switch to record RHYTHM and AUTO PLAY ACCOMPANIMENT on TRACK 2.

30 MERGE 1-2 switch (PV30 only)

This switch is used to transfer music information recorded on TRACK 1 to TRACK 2, or overdub TRACK 1 and TRACK 2.

31 START/STOP switch (PV30 only)

Press this switch to start recording/playback for TRACK 1.

32 REPEAT switch (PV30 only)

Press this switch to play back the recorded music repeatedly.

33 PAUSE switch (PV30 only)

Press this switch to temporarily suspend recording or playback.

(Refer to Chapter 6, "Using RAM Cards".)

34 Card slot (PV30 only)

For inserting a RAM card, for offline memory storage.

35 SAVE switch (PV30 only)

Press this switch to save the music information on the RAM card.

36 LOAD switch (PV30 only)

Press this switch to load the music information from the RAM card to SEQUENCER memory.

37 CARD switch (PV30 only)

Press this switch when you use a card for SAVE/LOAD; pressing this switch also allows you to directly access the RAM card.

(Refer to Chapter 8, "Other Functions".)

38 TRANSPOSE slide control

This is used to transpose the notes of the Digital Piano.

39 Soft pedal jack

Connect the soft pedal to this jack.

40 Damper pedal jack

Connect the damper pedal to this jack.

(Refer to Chapter 7, "MIDI".)

41 MIDI jacks

The MIDI jacks are used for connecting other digital music instruments and communicating musical sound information.

(Others)

42 Input level selection switch (L/H)

This switch is used to change the level of the input signal at the LINE IN jack.

When input level is high, set the switch at the L position and when input level is low, set it at the H position.

43 LINE IN jack

By connecting a digital musical instrument or cassette deck to this jack, music from the connected instrument is output from the speakers of the Digital Piano. In this case, output sound level cannot be adjusted with the volume slide control of the Digital Piano; you should adjust the volume controls of the connected instrument. For monaural signals, use the L jack.

44 Expression jack

This jack is used for connecting the optional expression pedal (V-20X). The effect of the expression pedal also effects the signals input from the LINE IN jack.

45 LINE OUT jack

Use the LINE OUT jack to output the Digital Piano sounds to external audio equipment, e.g., an amplifier. When you connect the line output to a cassette deck, you can record your music on cassette tape. The output level is adjustable using the MASTER VOLUME slide control. For monaural signals, use the L jack.

46 Output level selection switch (L/H)

This switch is used to change the signal level at the LINE OUT jack.

H position for high output level

L position for low output level

4-B. Choose the two tones you prefer by pressing two tone selector switches at the same time.

Note:

Assigning two different tones to a single key strike is referred to as the DUAL mode.

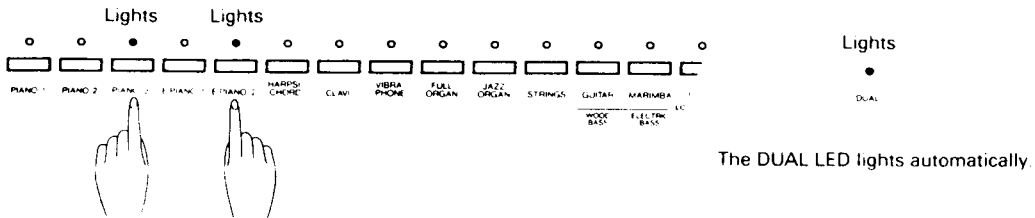

Press the switches at the same time.

5. Strike a key.

Note:

- In the SINGLE mode, you can play up to 16 notes at the same time, the sound is 16 note polyphonic.
- In the DUAL mode, simultaneous playing of up to 8 notes is possible, 8 note polyphonic.

There are many different effects you can create by combining different tones. Try changing the instrumental tone. Experiment, change the music's sound by pressing different tone selector switches.

Note:

To cancel the DUAL mode, press any new tone selector switch, or one of the two switches already selected once again.

6. Adjust volume level.

Output volume level is controlled with the MASTER VOLUME slide control.

In the DUAL mode, use the DUAL/SPLIT BALANCE slide control to change the balance between the two tones you've chosen.

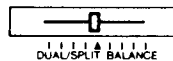

Left tone volume increases. ← → Right tone volume increases

Which tone is "right" and which tone is "left" is determined by the relative positions of the two tone switches you've selected, which one is further to the left or right of the other.

Example:

When PIANO 1 and STRINGS are selected, the left tone is PIANO 1 and the right tone is STRINGS, as PIANO 1 is to the left of STRINGS.

7. Add the CHORUS effect.

Pressing this switch adds the CHORUS effect. All the sounds become more animated. Using the CHORUS effect will add immediate excitement to the melody you are playing.

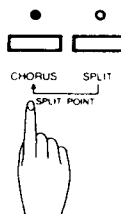

■ Playing the Digital Piano in its SPLIT mode

Note:

When you choose to play in the SPLIT mode, the keyboard is divided into two sections, the lower keyboard and the upper keyboard. Different tones may be played by the keys in each half.

1. Choose the tone for the upper keyboard.

Choosing the tone for the upper keyboard is easy. Simply press the tone selector switch as you would when selecting the tone for SINGLE mode operation.

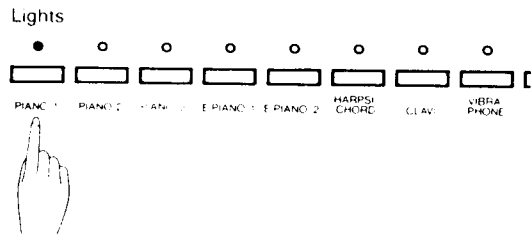

2. Press the SPLIT switch.

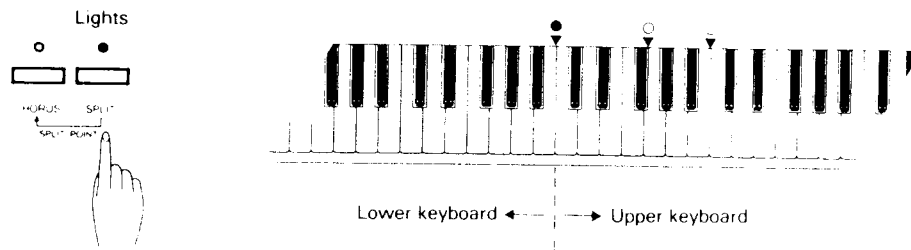

The point where the keyboard is split is indicated by the lighted SPLIT LED above the keys. The keyboard is now divided into its two sections — upper and lower. The LED will remind you where you divided the keyboard. You can press the SPLIT switch first, before choosing the sound you want for the upper section.

Note:

To change the point where the keyboard is split; press the CHORUS switch while holding down the SPLIT switch. Each time the CHORUS switch is pressed, the SPLIT POINT will change, moving higher, then back down in a regular sequence.

When the keyboard has been divided, the tone chosen in step 1 above is played by the keys in the upper keyboard. Immediately after dividing the keyboard, the WOOD BASS sound is automatically assigned to the keys in the lower keyboard. The WOOD BASS LED flashes to remind you of this choice.

Note:

To change to the DUAL mode while you are playing the keyboard in the SPLIT mode, you have to first cancel the SPLIT mode, and then select the DUAL mode. Please note that going from the DUAL mode to the SPLIT mode is not possible if the AUTO PLAY ACCOMPANIMENT switch is ON.

3. Changing the tone for the lower keyboard.

To change the tone selected for the lower keyboard, press the desired instrument selector switch while simultaneously pressing the SPLIT switch.

When you select any of the 5-switches on the far right, the LOWER TONE is selected. The lower keyboard tone selected stays in effect until the power is turned off. The LOWER TONES you may choose from include WOOD BASS, ELECTRIC BASS, SLAP BASS, SYNTH BASS or TUBA.

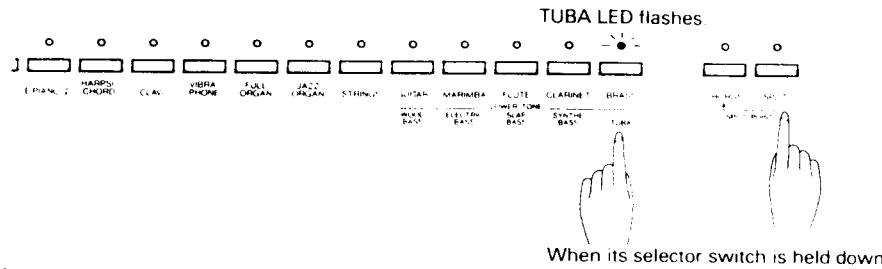

4. Now you're ready to play.

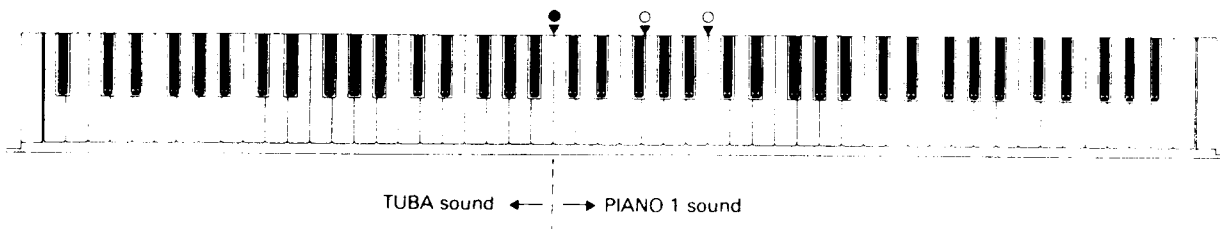

Selected tones will be played individually by the lower and upper keyboard.

The LED indicators of selected tones confirm at a glance the upper and lower keyboard sound selections. The LED indicating the tone chosen for the upper keyboard stays lit steadily, while the LED indicating the tone chosen for the lower keyboard flashes on and off.

5. Balance the volume between the lower and upper keyboard to achieve the effect you desire.

Use the DUAL/SPLIT BALANCE slide control to adjust the relative loudness of the two tones.

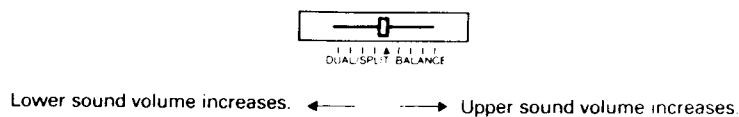

3. Adding RHYTHM

A PCM sound source is used to provide the RHYTHM in PV Series Digital Pianos. You can enjoy real percussion sounds, effectively recreating the sound of live music.

The 32 RHYTHM patterns available can be further enriched by adding different variations to your selected RHYTHM pattern.

How to use RHYTHM

1. Select the desired RHYTHM by pressing the appropriate RHYTHM selector switch. (Example: When the RHYTHM selector to the left is pressed.)

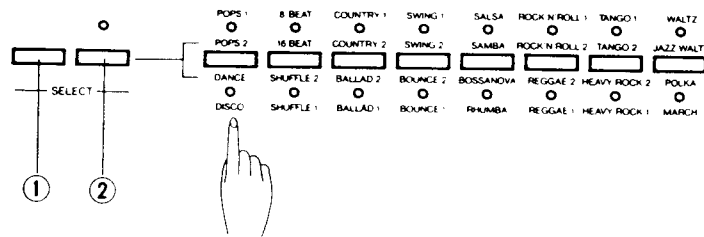

The left SELECT switch ① selects a RHYTHM pattern between the upper (POPS 1, POPS 2) and the lower (DANCE, DISCO) RHYTHMs.

The right SELECT switch ② selects a RHYTHM pattern between the inner (POPS 2, DANCE) and the outer (POPS 1, DISCO) RHYTHMs.

Note:

The LED above the right SELECT switch lights when the inner RHYTHM is selected.

2. Adjust the RHYTHM volume.

Note:

Set the RHYTHM VOLUME slide control in the center before starting the RHYTHM, then further adjust to your desired volume. If the MASTER VOLUME slide control is at the lowest level, only a faint volume can be produced, even if you move the RHYTHM VOLUME slide control to its maximum level.



Volume decreases. ← → Volume increases.

3. Start the RHYTHM.

Note:

When you start the RHYTHM, you can also start the AUTO PLAY ACCOMPANIMENT at the same time, when the AUTO PLAY ACCOMPANIMENT ON switch is activated. See page 11.

• **SYNC START switch**

When you press the SYNC START switch, the LED above the START/STOP switch flashes and the Digital Piano is in the RHYTHM standby mode. The RHYTHM starts and the LED lights at the same time you strike the first key.

Note:

The RHYTHM starts when any key on the keyboard is struck. To stop the RHYTHM, press the START/STOP switch or the INTRO/ENDING switch.

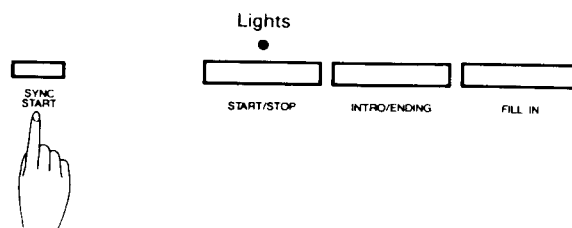

● **START/STOP switch**

Immediately after you press the START/STOP switch, the RHYTHM starts. Pressing this switch again while the RHYTHM is being played, stops it.

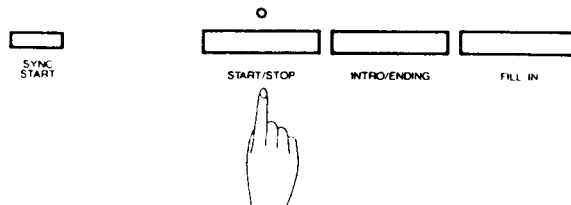

● **INTRO/ENDING switch**

When you press the INTRO/ENDING switch, the RHYTHM starts after one-bar of introduction is played. If this switch is pressed while the RHYTHM is being played, it stops, ending in its finish pattern.

Note:

The INTRO/ENDING pattern matching the selected RHYTHM pattern is preset. You can start or stop the RHYTHM to add a professional touch to your music.

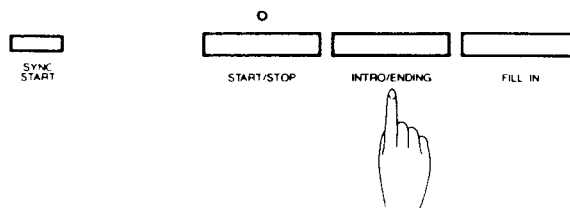

4. Adjust RHYTHM tempo with the TEMPO slide control.

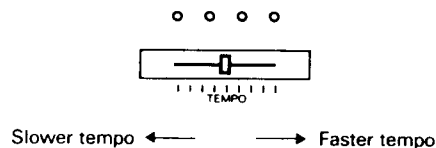

RHYTHM tempo slows down as the TEMPO slide control is shifted left, and speeds up as it is shifted to the right.

The LEDs above the TEMPO slide control flash from the left to the right in time with each succeeding beat, indicating the RHYTHM pattern and tempo.

Note:

The TEMPO LED on the left flashes in time with the currently programmed tempo before the RHYTHM actually starts. This allows you to approximately adjust the tempo before beginning to play.

5. To Stop the RHYTHM.

Press the (START)/STOP switch or (INTRO)/ENDING switch. See Step 3.

■ **Adding Variations to the RHYTHM (VARIATION)**

The three switches in the VARIATION section and the FILL IN switch in the RHYTHM section add variations to RHYTHMs (AUTO PLAY ACCOMPANIMENT).

Note:

- * Varying the RHYTHM also varies the AUTO PLAY ACCOMPANIMENT pattern when the AUTO PLAY ACCOMPANIMENT ON switch is activated.
- * Variations and FILL IN patterns matching the RHYTHM you've chosen are preset.

● **FILL IN switch**

Pressing the FILL IN switch while a RHYTHM is being played temporarily changes the RHYTHM. The start of the FILL IN depends on the time you press the FILL IN switch.

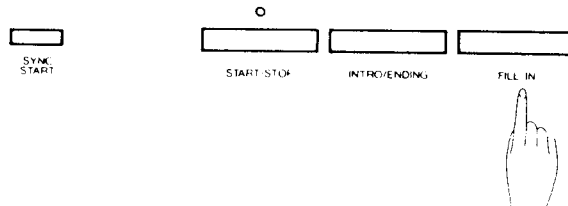

When you press the switch in the first or the second beat, the FILL IN pattern starts immediately and lasts through the end of the bar.

When you press the switch after the third beat, the FILL IN pattern starts from the first beat in the next bar.

● **VARIATION switch**

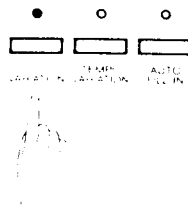

You can add variations to the RHYTHM by pressing the VARIATION switch.

Note:

The VARIATION switch can be used in combination with the TEMPO VARIATION and/or the AUTO FILL IN switch.

● **TEMPO VARIATION switch**

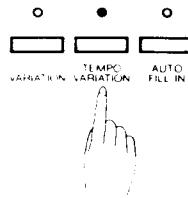

When you press the TEMPO VARIATION switch, the RHYTHM pattern will vary in two patterns in accordance with the set RHYTHM tempo.

Note:

The TEMPO VARIATION switch can be used in combination with the VARIATION and/or the AUTO FILL IN switch.

● **AUTO FILL IN switch**

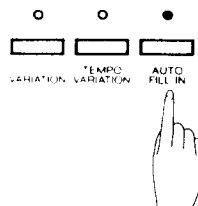

While the AUTO FILL IN switch is ON, a variety of patterns for FILL IN are inserted every four bars.

Note:

The AUTO FILL IN switch can be used in combination with the VARIATION and/or the TEMPO VARIATION switch.

4. Let's Use the AUTO PLAY ACCOMPANIMENT

You can enjoy a complex accompaniment to your playing when using the AUTO PLAY ACCOMPANIMENT feature. You simply play the chords.

■ How to use the AUTO PLAY ACCOMPANIMENT function

1. Select the desired RHYTHM.

Note:

For the procedure to select a RHYTHM, see page 8.

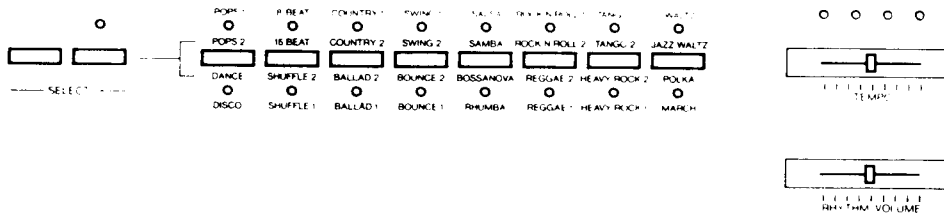

Also adjust the tempo and volume for the RHYTHM.

2. Press the AUTO PLAY ACCOMPANIMENT ON switch. Its LED confirms it is ON.

Note:

While the AUTO PLAY ACCOMPANIMENT ON switch is activated, you cannot play in the DUAL mode or the SPLIT mode. You can play only in the SINGLE mode.



One of the SPLIT POINT indicating LEDs above the keyboard lights.

Keys in the lower keyboard from the SPLIT POINT LED indicator are used as the keys to play the chords for the AUTO PLAY ACCOMPANIMENT.

Note:

To change the SPLIT POINT, press the CHORUS switch while holding down the SPLIT switch. See page 6.

3. Press the SYNC START switch.

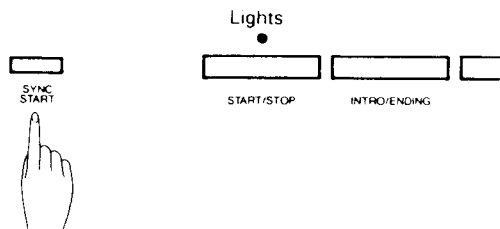

You can start only the RHYTHM first by pressing the START/STOP switch or the INTRO/ENDING switch.

Note:

If you strike a key for accompaniment with the AUTO PLAY ACCOMPANIMENT function ON before starting the RHYTHM, sound is created in the same tone as by the upper keyboard being played in the normal single mode.

4. Play a chord on the lower keyboard.

The RHYTHM and AUTO PLAY ACCOMPANIMENT start as soon as you strike the keys. (Refer to "Chord Table" on Page 34)

5. Adjust the volume.

Adjust balance with the COUNTER MELODY VOLUME, CHORD VOLUME, and BASS VOLUME slider control while listening to accompaniment sounds.

Note:

Tones are preset matching the RHYTHMs for COUNTER MELODY, CHORD, and BASS.

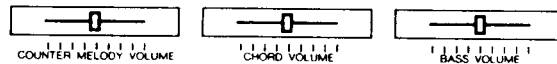

Volume decreases ← → Volume increases

6. Let's try adding variations to the AUTO PLAY ACCOMPANIMENT.

Press the VARIATION, TEMPO VARIATION, and/or AUTO FILL IN switches. Experiment to see which effect is most pleasing to you.

Variation using the FILL IN switches is also possible.

Note:

How the variation switches are used is explained in page 10.



7. To stop AUTO PLAY ACCOMPANIMENT.

The AUTO PLAY ACCOMPANIMENT stops when you stop the RHYTHM.

*** Press the START/STOP switch.**

The RHYTHM and AUTO PLAY ACCOMPANIMENT stops immediately when you press the START/STOP switch.

*** Press the INTRO/ENDING switch.**

When you press the INTRO/ENDING switch, the RHYTHM and AUTO PLAY ACCOMPANIMENT stop after finishing their pattern.

5. Recording Your Sound in SEQUENCER (PV30)

The SEQUENCER function allows you to record your music, either during manual playing or playing using RHYTHM and/or AUTO PLAY ACCOMPANIMENT functions in separate channels. These can be played back later.

You can use the SEQUENCER function to record difficult-to-play music using both hands; you can concentrate on playing one part at a time. The PV30 Digital Piano also has a MERGE function. Play a variety of parts in different tones, one by one, then merge them onto a single track.

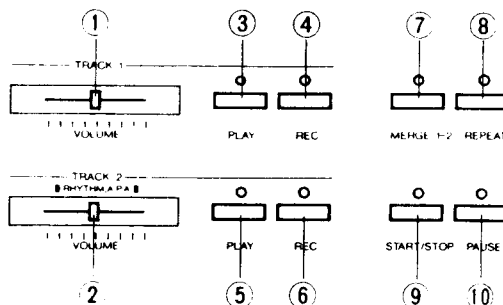

- ① **TRACK 1 VOLUME** ... The slider adjusts recording and playback sound level for TRACK 1.
- ② **TRACK 2 VOLUME** ... The slider adjusts sound level for recording and playback of RHYTHM and AUTO PLAY ACCOMPANIMENT for TRACK 2. This setting is not effective for information merged from TRACK 1.
- ③ **TRACK 1 PLAY** When you press the TRACK 1 PLAY switch, playback of information recorded on TRACK 1 stands by.
- ④ **TRACK 1 REC** When you press the TRACK 1 REC switch, recording on TRACK 1 stands by.
- ⑤ **TRACK 2 PLAY** When you press the TRACK 2 PLAY switch, playback of information recorded on TRACK 2 stands by.
- ⑥ **TRACK 2 REC** When you press the TRACK 2 REC switch, recording on TRACK 2 stands by.
- ⑦ **MERGE 1-2** When you press the MERGE 1-2 switch, information on TRACK 1 is copied to TRACK 2 and TRACK 1 is cleared to allow you to record further. The music recorded on TRACK 2 before this MERGE operation remains, with the sounds merged from TRACK 1 overlapped on top of it.
- ⑧ **REPEAT** Repeated playback occurs when you press this switch.
- ⑨ **START/STOP** For TRACK 1, the START/STOP switch functions as the start and stop control switch for recording and playback.
For TRACK 2, the START/STOP switch functions as the stop control switch for recording and playback. Please note that this switch does not function as the start control switch for TRACK 2.
- ⑩ **PAUSE** You can pause recording or playback temporarily by pressing the PAUSE switch. PLAY and RECORD modes can be changed during the PAUSE period (TRACK 1 only).
Press the PAUSE switch again or strike a key to restart the paused recording or playback.

■ Information Recorded on Each Track

● TRACK 1

TRACK 1 records manual playing (RHYTHM and AUTO PLAY ACCOMPANIMENT sections are not used). RHYTHM and AUTO PLAY ACCOMPANIMENT are not recorded.

The informations to be recorded are

- Keys played
- Tone selection information
- Position and variation of TRACK 1 VOLUME slide control
- Pedal ON/OFF status

● TRACK 2

TRACK 2 usually records information concerning RHYTHM and AUTO PLAY ACCOMPANIMENT. After you merge the TRACK 1 information to TRACK 2, TRACK 2 is a complete recording of the music which was on both tracks.

The informations to be recorded are

- RHYTHM selection information (including FILL IN and VARIATION information)
- Position and variation of RHYTHM VOLUME slide control
- AUTO PLAY ACCOMPANIMENT information (including FILL IN and VARIATION information)
- Position and variation of volume slide control (COUNTER MELODY VOLUME, CHORD VOLUME, BASS VOLUME) for AUTO PLAY ACCOMPANIMENT
- Position and variation of TEMPO slide control

5-1. Recording

- Manual play recording (TRACK 1)
 - Manual play recording Example 1
 - Recording while listening to RHYTHM Example 2
 - Recording while listening to RHYTHM and AUTO PLAY ACCOMPANIMENT Example 3
 - Recording while listening to TRACK 2 being played back Example 4
- Recording of RHYTHM and AUTO PLAY ACCOMPANIMENT (TRACK 2)

■ Recording to TRACK 1

1. Select a tone by pressing the desired tone switch.

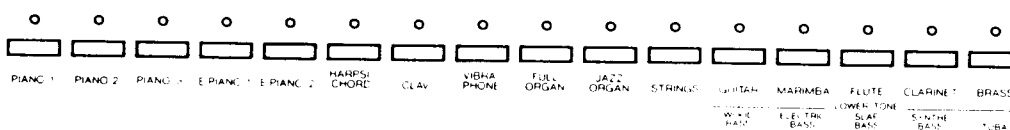

Press one of the tone selector switches.

Note:

- * It is possible to record in the SPLIT mode when the AUTO PLAY ACCOMPANIMENT ON is switched OFF. The procedure to set the tone in the SPLIT mode, refer to page 6. In this case, however, balance adjustment between the upper and lower keyboard using the DUAL/SPLIT BALANCE slide control is not possible. Balance is fixed at a preset level.
- * It is not possible to change the SPLIT POINT when the REC switch is activated. First turn off the REC switch, and then change the SPLIT POINT.

2. Press the TRACK 1 REC switch.

(Leave the TRACK 2 REC switch OFF.)

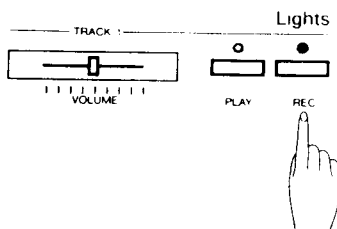

The LED above the REC switch lights.

3. Set the recording level for TRACK 1.



Lower ← Recording level → Higher

4. Start Recording

Example 1: Manual play recording

1) Turn OFF the RHYTHM.

Note:

If a RHYTHM is being produced, press the START/STOP switch in the RHYTHM section.

2) Turn the AUTO PLAY ACCOMPANIMENT ON switch to OFF.

3) Press the START/STOP switch in the SEQUENCER section. Now you can begin manual playing.

Example 2: Recording while listening to RHYTHM

- 1) Turn the AUTO PLAY ACCOMPANIMENT ON mode to OFF.
- 2) Select a RHYTHM.

Note:

See page 8 for the RHYTHM selection procedure.

- 3) Set the tempo while listening to the metronome.

Note:

- * Recorded music is played back at the same tempo it was made. Variations in tempo during recording are also recorded.
- * You can change the tempo during playback using the TEMPO slide control.

- 4) Set RHYTHM volume with the RHYTHM VOLUME slide control.

Example 3: Recording while listening to RHYTHM and AUTO PLAY ACCOMPANIMENT

- 1) Switch ON the AUTO PLAY ACCOMPANIMENT ON switch. The LED above this switch will light.

Note:

Keys in the lower note section divided by the SPLIT POINT are for AUTO PLAY ACCOMPANIMENT. Keyboard playing of these keys is not recorded. It is not possible to change the SPLIT POINT when the REC switch is activated. First turn off the REC switch, and then change the SPLIT POINT. The procedure to set the SPLIT POINT is explained on page 6.

- 2) Select the RHYTHM and adjust the tempo and volume as in Example 2.

For Examples 2 and 3:

- A. Start playing by pressing either the START/STOP switch or the INTRO/ENDING switch in the RHYTHM section.

Note:

Recording starts at the same time the RHYTHM and AUTO PLAY ACCOMPANIMENT start. If you press the START/STOP switch in the SEQUENCER section, the RHYTHM and AUTO PLAY ACCOMPANIMENT don't start. But you can record the manual playing.

- B. Start playing by pressing the SYNC START switch in the RHYTHM section.

Note:

RHYTHM and AUTO PLAY ACCOMPANIMENT start when you strike a key. Recording starts at the same time

Example 4: Recording while listening to TRACK 2

- 1) Press the TRACK 2 PLAY switch.

Note:

For the procedure to record on TRACK 2, refer to page 16 and the explanation for MERGE.

- 2) Start playing by either of the following methods.

- A. Start playing after pressing the START/STOP switch in the RHYTHM section.

Note:

If you press the START/STOP switch in the SEQUENCER section, sounds recorded on TRACK 2 are not produced. But you can record to TRACK 1.

- B. Start playing after pressing the SYNC START switch in the RHYTHM SECTION.

Note:

Sounds recorded on TRACK 2 are reproduced as you strike a key. Recording begins at the same time.

5. Stop recording when you finish playing. You can stop recording using either of the following methods.

- A. Press the START/STOP switch in the SEQUENCER section.

- B. Press the START/STOP switch in the RHYTHM section.

Note:

You can stop recording by pressing the INTRO/ENDING switch in the RHYTHM section if both of the PLAY and REC switches for TRACK 2 are OFF. (For Examples 2 and 3.)

■ Recording on TRACK 2

1. Press the TRACK 2 REC switch.

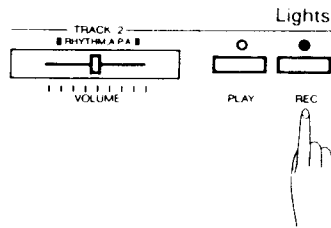

The AUTO PLAY ACCOMPANIMENT function is automatically turned on and the SPLIT POINT is automatically set. To change the SPLIT POINT, you have to first turn off the REC switch.

Note:

- * The AUTO PLAY ACCOMPANIMENT cannot be turned OFF while you are recording on TRACK 2.
- * To change the SPLIT POINT, refer to page 6.

To record on TRACK 1 at the same time, press the TRACK 1 REC switch after setting the desired tone.

Note:

In this case, recording on TRACK 1 in the SPLIT mode is not possible.

2. Select a RHYTHM.

Note:

For the procedure to select a RHYTHM, see page 8.



Press the VARIATION switch whenever you desire.

3. Adjust tempo and volume balances.

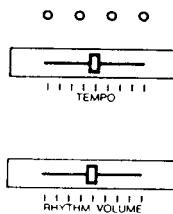

Listen to the metronome to adjust the tempo.

Note:

- * Variation of tempo and balance during playing are also recorded.
- * You can change the tempo and volume during playback. However, when a recorded change in tempo or volume is played back your manual change is cancelled, and the tempo or volume as recorded becomes effective for playback.

4. Set the recording level for TRACK 2.

5. Start recording.

You can start recording using either of the following methods.

- A. Start playing by pressing either the START/STOP switch or the INTRO/ENDING switch in the RHYTHM section.

Note:

- * Recording starts as soon as you press the switch.
- * If you start recording by pressing the START/STOP switch in the SEQUENCER section, AUTO PLAY ACCOMPANIMENT does not start, even when you strike a chord. Therefore, recording on TRACK 2 is not possible.

B. Start playing by pressing the SYNC START switch in the RHYTHM section.

Note:

RHYTHM and AUTO PLAY ACCOMPANIMENT start when you strike a key. Recording starts at the same time.

6. Stop recording when you finish playing. You can stop recording using either of the following methods.

A. Press the START/STOP switch in the SEQUENCER section.

B. Press the START/STOP switch or the INTRO/ENDING switch in the RHYTHM section.

To pause the recording ...

1. Press the PAUSE switch if you want to pause the recording temporarily.

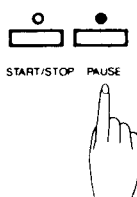

The LED above PAUSE switch lights during the PAUSE.

Note:

During the PAUSE, it is possible to change from playback to recording only for TRACK 1 (not for TRACK 2). This function can be used to record your playing again from some halfway point if you initially failed to record your playing.

2. To cancel the PAUSE, press the PAUSE switch again.

Note:

The START/STOP switch in the RHYTHM or the SEQUENCER section cannot be used to cancel the PAUSE. If you press the START/STOP switch, the recording is stopped.

Striking a key also cancels the PAUSE and restarts the recording.

5-2. Playback

After you've recorded your playing, play it back and listen to the music you created.

1. Press the PLAY switch for the track you want to play back.

Note:

If you want to listen to the recorded sounds on both tracks, press the PLAY switch for both tracks.

The LED above the PLAY switch lights (standby state).

2. Set the volume for playback.

Note:

The VOLUME slide control in the SEQUENCER section are used for both input level adjustment for recording, and for output level (volume) adjustment during playback.

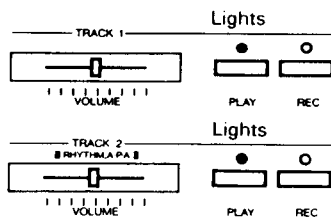

3. Press the REPEAT switch to repeat the playback.

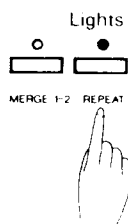

While the repeat function is on (REPEAT LED lit), sounds are played back again from the beginning, several seconds later after playback is completed.

Note:

If you have pressed the PLAY switch for both TRACK 1 and TRACK 2, playback is repeated for both TRACK 1 and TRACK 2 after playback of the longest recorded track has been completed.

4. Start the playback.

You can start playback using either of the following methods.

A. Press the START/STOP switch in the RHYTHM section.

Note:

When you press the START/STOP switch in the SEQUENCER section, only sounds on TRACK 1 are played back. Playback from TRACK 2 is not possible even if you have pressed the PLAY switch for TRACK 2.

B. After pressing the SYNC START switch in the RHYTHM section, strike a key.

Note:

The INTRO/ENDING switch cannot be used for starting and stopping the playback.

Touch, tempo and volume balance are reproduced in playback as they were recorded.

Note:

For playback from both TRACKs 1 and 2, sounds are reproduced according to the tempo recorded on whichever track was recorded last.

You can change tempo and volume as required.

5. To pause the playback.

1) Press the PAUSE switch if you want to pause the playback temporarily.

Note:

During the PAUSE, it is possible to change from playback to recording only for TRACK 1 (not for TRACK 2).

2) To cancel the PAUSE, press the PAUSE switch again.

Note:

The START/STOP switch in the RHYTHM or the SEQUENCER section cannot be used to cancel the PAUSE. If you press the START/STOP switch, the playback is stopped.

6. The playback stops automatically after all the recorded sounds on that track have been reproduced.

To stop the playback in the repeat mode, press the START/ STOP switch in the RHYTHM or SEQUENCER section.

5-3. Learning How to Use The SEQUENCER Effectively (MERGE Function)

If you want to play a music selection which is difficult to play using both hands, or enjoy ensemble mixing of different tones, the MERGE function will be a great help to you.

■ Editing sounds of a part

1. Record your playing only for left hand on TRACK 1.

- 1) Set the tone for left hand play.
- 2) Press the REC switch of TRACK 1.
- 3) Set the RHYTHM matching the image of the music to be played.

Note:

Tempo can be adjusted when playing back your music. Play the music more precisely by setting the tempo a little slower. This will allow you a bit more time to achieve the effects you might want to obtain.

For the procedure to set the tempo, refer to page 9. Example 2, "Recording while listening to RHYTHM"

- 4) Start recording and begin playing.

Note:

For the procedure to start recording, refer to page 15, Example 2.

- 5) Stop the recording after you have finished playing.

2. Press the MERGE 1-2 switch.

The LED above the MERGE 1-2 lights while the MERGE function is active

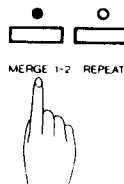

The music played by your left hand and recorded on TRACK 1 can be copied to TRACK 2. When TRACK 1 is copied to TRACK 2, TRACK 1 is cleared.

Note:

In the normal recording procedure, it is not possible to record manual playing.

3. Record the right hand play on TRACK 1 while reproducing the sound recorded on TRACK 2.

Note:

For the recording procedure, refer to page 15, Example 4, "Recording while listening to TRACK 2".

4. Play back TRACKs 1 and 2 simultaneously.

Adjust tempo and volume during the playback to suit your task.

Note:

When you record two tracks playing with both hands on each, playing them back simultaneously allows you to enjoy a four-handed musical performance.

5. Press the MERGE 1-2 switch again, and

The sounds on TRACK 1 are copied to TRACK 2, overlapping the currently recorded sounds. You can again record another part on TRACK 1.

■ Editing ensemble

1. Record the RHYTHM and AUTO PLAY ACCOMPANIMENT on TRACK 2.

Note:

For the setting and recording procedure, refer to page 16, "Recording on TRACK 2".

2. Record your performance on TRACK 1 while playing back sounds on TRACK 2.

Note:

For the recording procedure, refer to page 15, Example 4, "Recording while listening to TRACK 2".

You can record on TRACKs 1 and 2 at the same time. Refer to page 16.

3. Press the MERGE 1-2 button.

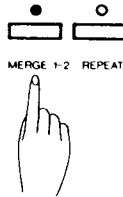

The LED above the MERGE 1-2 lights while the MERGE function is active.

The sounds recorded on TRACK 1 are copied to TRACK 2 and TRACK 1 is cleared.

4. While playing back the sounds on TRACK 2, play other part for recording on TRACK 1.

Note:

For sounds merged from TRACK 1, it is not possible to adjust the playback volume with the VOLUME slide control for TRACK 2. Sounds on TRACK 1 are merged to sounds on TRACK 2 at the recorded volume. The TRACK 2 VOLUME control is effective only for the RHYTHM and the AUTO PLAY ACCOMPANIMENT sounds.

5. Press the MERGE switch.

You can enjoy making multi-harmonic recordings by playing different parts in different tones, and then transferring the recorded parts from TRACK 1 to TRACK 2, to create a complex, multi-featured sound track.

6. After you have played and recorded all parts, playback the sounds recorded on TRACKS 1 and 2 simultaneously to reproduce your complete musical creation.

6. Using RAM Card (PV30)

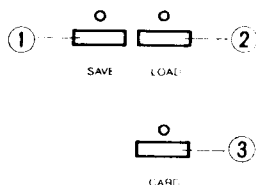

1. **SAVE** The SAVE function allows you to save the SEQUENCER information stored in the PV30 keyboard memory to a RAM card.
2. **LOAD** The LOAD function allows you to load the SEQUENCER information stored in a RAM card to the PV30 memory.
3. **CARD** The function called up by pressing the CARD switch allows you to directly access the RAM card without using memory area of the PV30.

6-1. Save

Save the information stored in the PV30 SEQUENCER to a RAM card in the following cases.

— When you want to keep the SEQUENCER information (sounds) you have created for a long time.

Information stored in the SEQUENCER can be retained for about seven days after the power to the Digital Piano is turned off. However, to safely save important information, transfer the PV30 memory to a RAM card.

— Before you store new information in the SEQUENCER memory.

The information stored in memory is replaced with newly recorded information (on both tracks).

■ How to SAVE

1. Correctly insert a RAM card into the slot.

Note:

Use a DC-32 card (32 kbytes). PV30 does not accept other cards.

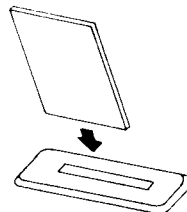

Insert the RAM card so the KAWAI CARD label is faced up. Be sure to match the marks on the keyboard with those on the card.

Note:

If you insert an incompatible card, or the card is not inserted correctly, no LEDs will light when you press the CARD, SAVE, or LOAD switches.

2. Press the SAVE switch while holding down the CARD switch.

Note:

* Pressing the SAVE or LOAD switch independently without pressing the CARD switch does not call up the desired function.

* Saving the information to a RAM card from the PV30 memory automatically erases information previously stored in the card.

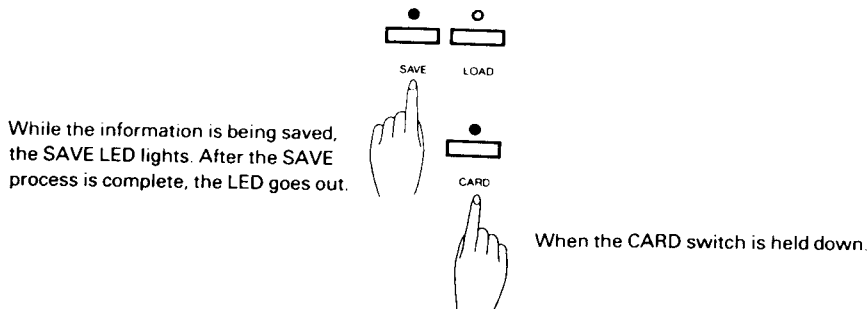

3. Remove the RAM card.

Be careful when you remove the card.

■ Before you use a new card

You cannot use a brand-new card as it is. Before you use a new card, insert the card correctly, and press the SAVE switch. After the SAVE procedure, the card will be able to be used.

■ When the data in the card is bad ...

If you insert a compatible card other than the Kawai DC-32 or remove the CARD during the SAVE procedure, the data in the Card might be bad. If this is the case, when you press the CARD switch, the LED above the switch goes out after flashing for a moment, which indicates that the Digital Piano detects something wrong in the Card. Make sure that the Kawai DC-32 Card is correctly inserted and that the SAVE function is operating.

6-2. Load

The process to transfer the information saved on a RAM card to the SEQUENCER memory is called LOAD.

■ How to LOAD

1. Correctly insert a RAM card into the slot.

Insert the RAM card so the KAWAI CARD label is faced up. Be sure to match the marks on the keyboard with those on the card.

Note:

Handle the card carefully. LOAD is not possible if the card has been inserted incorrectly.

2. Press the LOAD switch while holding down the CARD switch

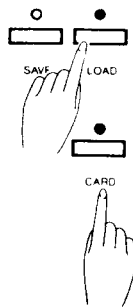

While the information is being loaded, the LOAD LED lights. After the LOAD process is complete, the LED goes out. The information is loaded from the RAM card to the SEQUENCER memory.

Note:

Information previously stored in the SEQUENCER memory is replaced with new information by the LOAD process.

6-3. Memory Selection (Directly Access)

Usually, your sounds are stored in the PV30 SEQUENCER memory. However, if you use the directly access function, memory area in the RAM card can be accessed directly without using the SEQUENCER memory area.

■ Selecting RAM Card Memory

1. Correctly insert a RAM card.
2. Press the CARD switch.

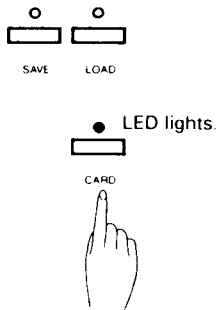

The RAM card memory area is selected instead of the SEQUENCER memory area.

3. If you transfer recorded sounds to the SEQUENCER,

Note:

The recording procedure is the same as for recording your sounds into SEQUENCER memory. Refer to page 14. Recording information for each track is directly saved onto a RAM card.

4. If you reproduce sounds stored in the SEQUENCER memory,

Note:

The playback procedure is the same as the reproducing sounds stored in the SEQUENCER memory. Refer to page 17. The sound data for each track, as stored in the RAM card, is reproduced.

7. MIDI

MIDI, the Musical Instrument Digital Interface, is an internationally standard for connecting synthesizers, drum machines, and other electronic musical instruments so that they may freely exchange performance data. The nature of the information depends on the particular instruments involved.

7-1. Outline of MIDI

■ MIDI connections

Connecting two MIDI instruments is as easy as plugging the ends of a MIDI cable (available separately) into each instrument's MIDI jacks. The MIDI standard provides three such jacks.

IN: Accepts MIDI data
OUT: Transmits MIDI data from the instrument
THRU: Passes MIDI data received on to another instrument.

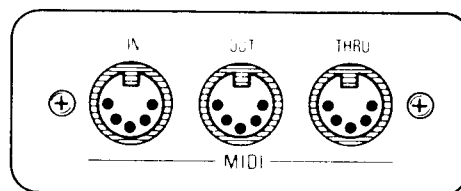

■ MIDI capabilities of the PV series

MIDI Interface of the PV series Digital Pianos provides the following functions.

- Setting of transmission/reception channels
- Transmission and reception of keyboard information
- Transmission and reception of program (tone) number
- Transmission and reception of ON/OFF information of soft pedal and damper pedal
- ON/OFF setting for local control
- Transmission of clock data
- Transmission and reception of start/stop information

7-2. MIDI Operation

■ Connecting MIDI Cables

Always be sure the cables are correctly connected.

— To control an instrument connected to the Digital Piano.

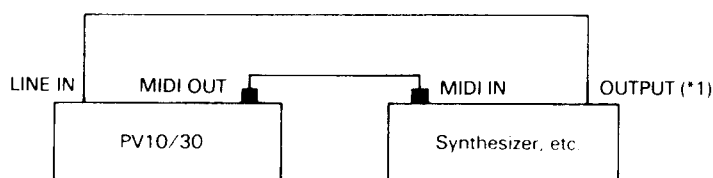

Note:

If the instrument to be connected does not have an incorporated amplifier and speaker, connect the instrument's OUTPUT jack to the LINE IN jack of the Digital Piano or other associated equipment.

— To control the Digital Piano using an instrument connected to the Digital Piano.

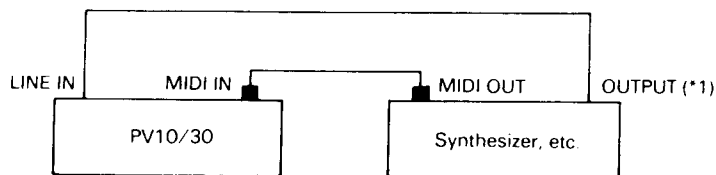

Note:

Connect the instrument's OUTPUT jack to the LINE IN jack of the Digital Piano or other associated equipment.

■ Setting MIDI functions

You can select the desired MIDI function in the programming mode.

— To enter the programming mode

Press the PIANO 1, PIANO 2, and PIANO 3 switches while holding down the CHORUS switch.

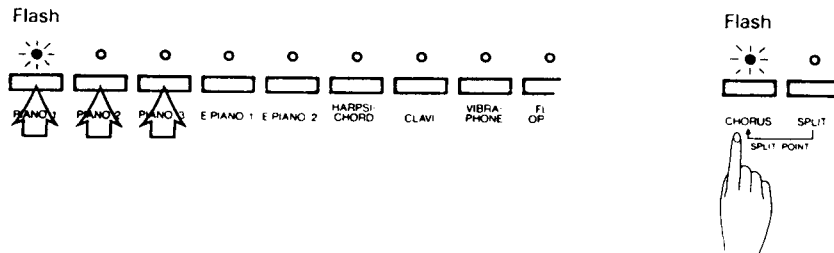

The LEDs above the CHORUS and PIANO 1 switches start flashing to indicate that the piano is in the programming mode.

Note:

While the PIANO 1 LED is flashing in the programming mode, you can set the program number. This procedure is explained below.

— To cancel the programming mode

Press the CHORUS switch while its LED is flashing.

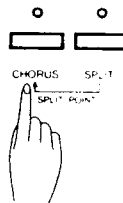

The CHORUS LED is switched off and the state the Digital Piano was in before entering the programming mode is restored.

■ Sending a program number (tone color code)

When the digital piano enters the programming mode, the CHORUS LED and the PIANO 1 LED begin flashing. This indicates that a program number can be transmitted. First, you must set the program number of the instrument which receives the data.

Note:

When the PV series Digital Piano is set as the data receiving instrument, the received program number corresponds to the tone selector switch (from the left, program No.0 = PIANO 1, No.1 = PIANO 2, ... No.15 = BRASS)

Transmission of a program number is possible by either of the following two methods.

A. Program number transmission using black keys

The lower thirteen black keys, from the left, give the first two digits of the program number ("00"- "12"). The next ten black keys are used to set the final third digit of the program number ("0"- "9").

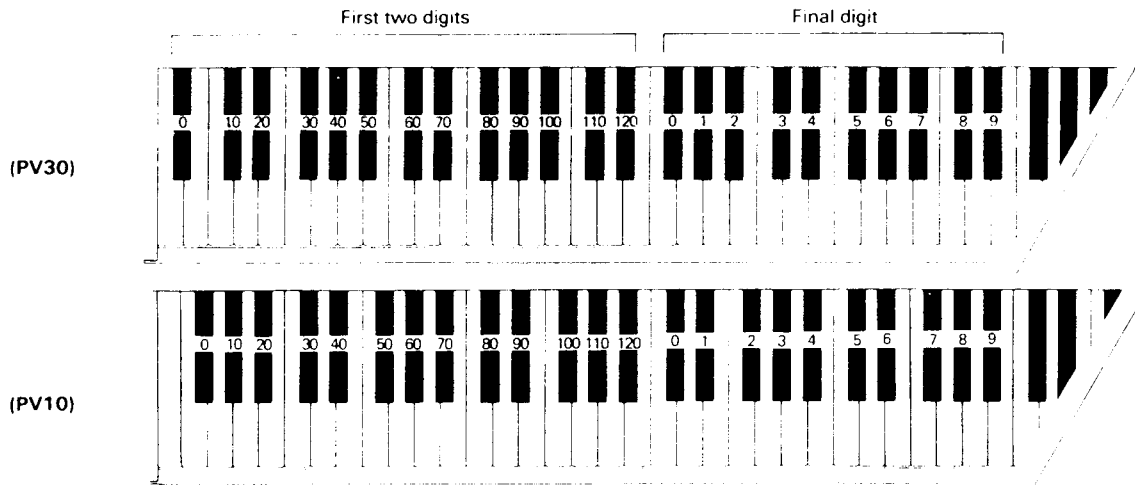

Example: Program No: 3

Press the "00" key and then the "3" key

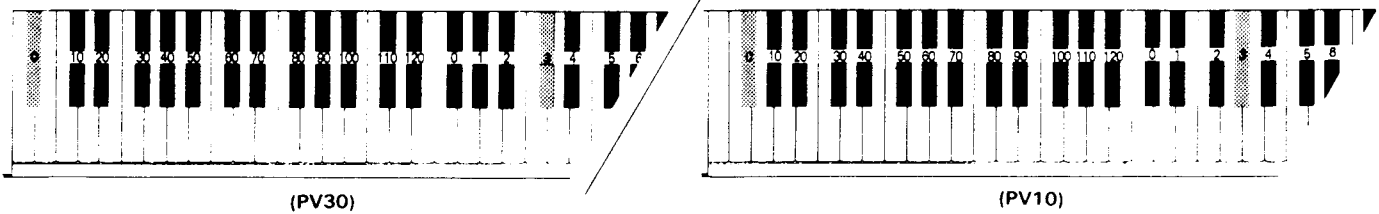

Program No: 20

Press the "20" key and then the "0" key.

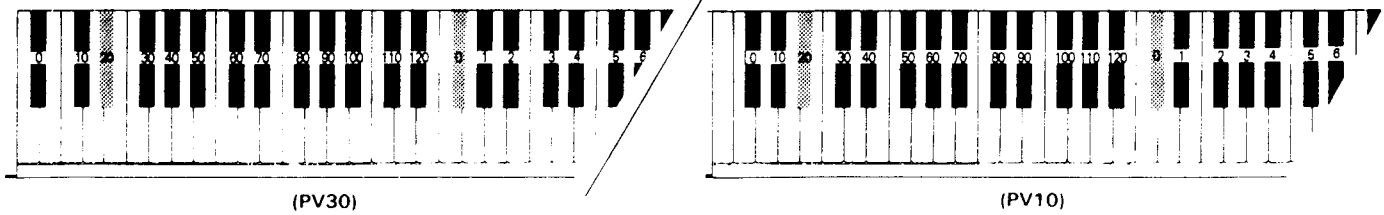

Program N: 42

Press the "40" key and then the "2" key.

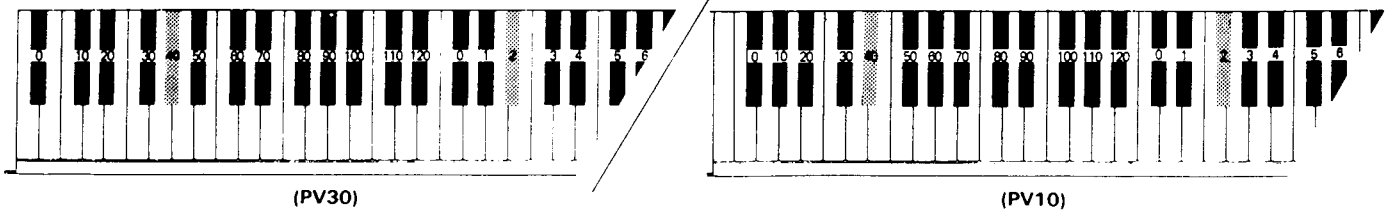

B. Program number transmission using a tone selector switch



ON Press the highest white key with the piano in the program number transmission mode (CHORUS and PIANO 1 LEDs are flashing).

After canceling the programming mode, if you change the tone of the digital piano, it also changes the tone of any connected instrument, a synthesizer for example will change to the new program number.

Note:

The program number to be transmitted corresponds to the tone selector switch. (From the left, PIANO 1 = Program No. 0, PIANO 2 = Program No. 2,, BRASS = Program No. 15)

OFF Press the highest key with a piano in the program number transmission mode (CHORUS and PIANO 1 LEDs are flashing).

This cancels program number transmission using a tone selector switch.

After you have set the desired program number, set the other functions. If you don't want to set any other functions, press the CHORUS switch to quit the programming mode.

■ Setting a channel

Enter the programming mode by pressing the PIANO 1, PIANO 2 and PIANO 3 switches, all at the same time, while holding down the CHORUS switch. Then press the PIANO 2 switch in the programming mode, and the CHORUS and the PIANO 2 LEDs will begin flashing to indicate that the Digital Piano is in the MIDI channel setting mode.

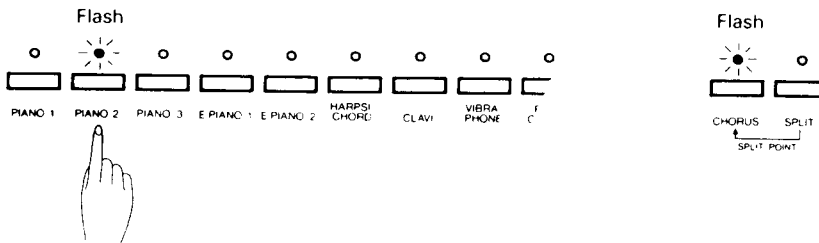

For channel setting, you use the 16 lower white keys; each key sequentially corresponds to a channel number.

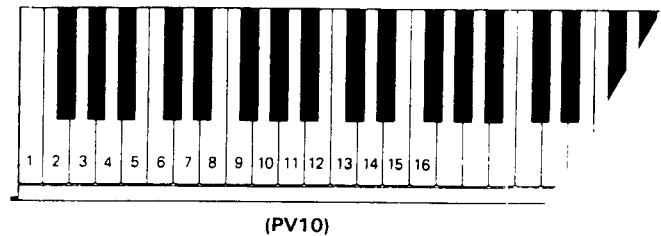
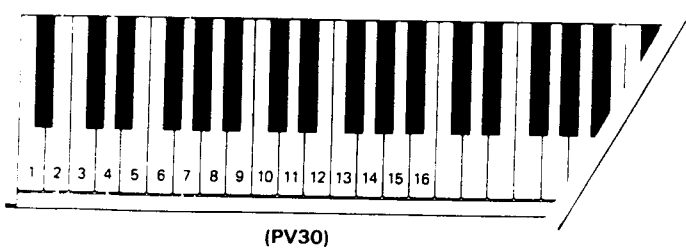

Channel selection is possible from channel 1 to channel 16.

■ Setting multi-timber mode

When the Digital Piano receives the MIDI signal while the multi-timber mode is ON, multiple tones corresponding to individual channels are output.

Note:

In the SPLIT mode while the multi-timber mode is ON, the transmission channel selected is assigned to the upper keyboard. For the lower keyboard, a channel one number higher than the upper keyboard channel number is automatically set. When you select channel number 16 for the upper keyboard, the lower keyboard channel number is 1.

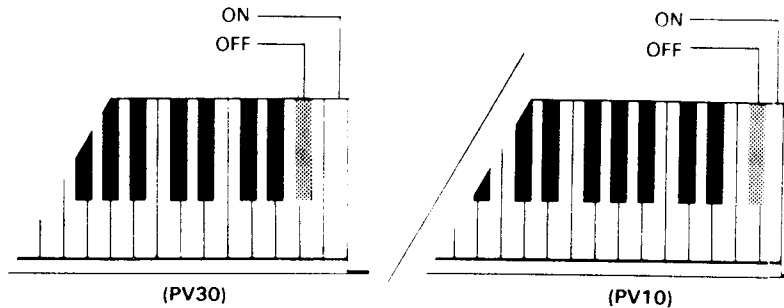

ON Press the highest white key in the MIDI channel setting mode (CHORUS and PIANO 2 LEDs are flashing).
 OFF Press the highest black key in MIDI channel setting mode (CHORUS and PIANO 2 LEDs are flashing).

In the multi-timber mode, the tone corresponded to each reception channel is indicated in the following table.

Reception Channel	Tone	Program No.	Remark
1	PIANO 1-3	0-2	No. 0-2 correspond to PIANO 1-PIANO 3. (No. 3 or larger program number corresponds to PIANO 1)
2	E. PIANO 1-2	0-1	No. 0, No. 1 correspond to E. PIANO 1, E. PIANO 2. (No. 2 or larger program number corresponds to E. PIANO 1)
3	HARPSICHORD	0-127	HARPSICHORD for all program numbers.
4	CLAVI	0-127	CLAVI for all program numbers.
5	VIBE	0-127	VIBE for all program numbers.
6	FULL ORGAN, JAZZ ORGAN	0-1	No. 0 corresponds to FULL ORGAN, and No. 1 to JAZZ ORGAN. (No. 2 or larger program number corresponds to FULL ORGAN)
7	STRINGS	0-127	STRINGS for all program numbers.
8	GUITAR	0-127	GUITAR for all program numbers.
9	MARIMBA	0-127	MARIMBA for all program numbers.
10	FLUTE	0-127	FLUTE for all program numbers.
11	CLARINET	0-127	CLARINET for all program numbers.
12	BRASS	0-127	BRASS for all program numbers.
13	CHORD 1-9	0-8	See separate table 1 (three-note polyphonic)
14	COUNTER MELODY 1-9	0-8	See separate table 1 (two-note polyphonic)
15	BASS 1-9	0-8	See separate table 1 (monophonic)
16	PCM drum	—	Program numbers are ignored. Percussion tone corresponds to keys. See separate table 2.

• Table 1

Program No.	1	2	3	4	5	6	7	8	9
Tone									
CHORD	PIANO	E. PIANO	CLAVI	BANJO	A. GUITAR	E. GUITAR	BRASS	ACCORDION	SYNTH
C. MELODY	PIANO	BELL	E. GUITAR	FUZZ GUITAR	BRASS	TRUMPET	CLARINET	FLUTE	VIOLIN
BASS	A. BASS 1	A. BASS 2	E. BASS 1	E. BASS 2	E. BASS 3	FUNK BASS	TUBA	SYNTH BASS 1	SYNTH BASS 2

• Table 2

Key	Instrument	Key	Instrument
D2	Bass Drum	E3	Bongo High
D2#	Rim Shot	F3	Bongo Low
E2	Snare Drum	F3#	Cowbell
F2	Electric Snare	G3	Conga High
F2#	Claps	G3#	Agogo High
G2	Tom High	A3	Conga Low
G2#	High Hat Closed	A3#	Agogo Low
A2	Tom Mid	B3	Timbales High
A2#	Hi Hat Open	C4	Timbales Low
B2	Tom Low	C4#	Triangle Closed
C3	Electric Tom High	D4	Tambourine
C3#	Crash	D4#	Triangle Open
D3	Electric Tom Low	E4	Claves
D3#	Ride	F4	Shaker

(The lowest C of 88 keys is taken as the C1)

After you have set the MIDI channel and the multi-timber mode, set the other functions. If you don't want to set any other functions, press the CHORUS switch to quit the programming mode.

■ Setting the local control

When the local control mode is OFF, no sound is output even when you press a key of the Digital Piano. The Digital Piano outputs sounds only when it receives a MIDI signal from the connected MIDI instrument. Usually, the local control is ON.

Note:

When you use the K5m as your sound source, or any other sound source module, connect the digital piano and the sound source module as illustrated below, and turn the local control OFF.

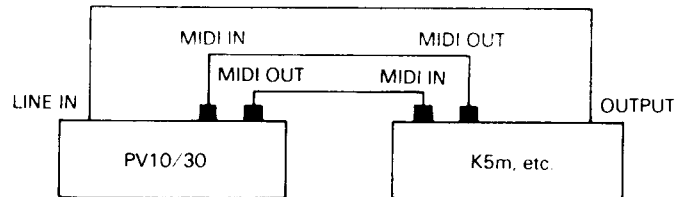

With the connection illustrated above, the tone for the lower keyboard can be output separately, in addition to adding overtones. For the settings of the sound source module, refer to the instruction manual for each piece of equipment. Press the PIANO 1, PIANO 2, and PIANO 3 switches, all at the same time, while holding down the CHORUS switch to enter the programming mode. Then press the PIANO 3 switch.

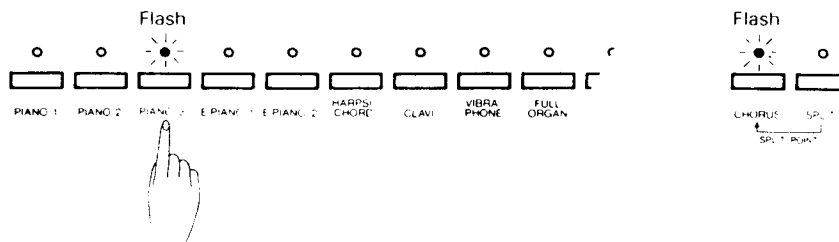

The CHORUS and PIANO 3 LEDs begin flashing, indicating that the Digital Piano has entered the local control setting mode.

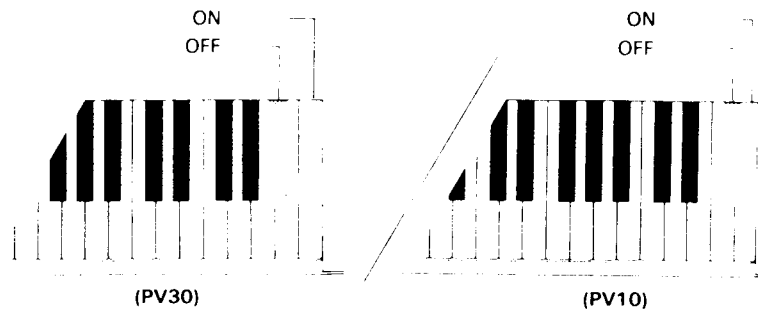

OFF Press the highest black key.
ON Press the highest white key.

Note:

You can turn the power OFF, then turn it back ON to turn local control ON instead of pressing the top white key.

After you have set local control, set the other functions. If you don't want to set any other functions, press the CHORUS switch to quit the programming mode.

■ Synchronization with Another Instrument

Since the PV Series Digital Piano sends the TIMING CLOCK and START/STOP commands, connecting the Digital Piano's MIDI OUT jack to a drum machine like the Kawai R-50 or R-100 MIDI IN jack allows you to start and stop the remote instrument from the Digital Piano. You can even control its tempo.

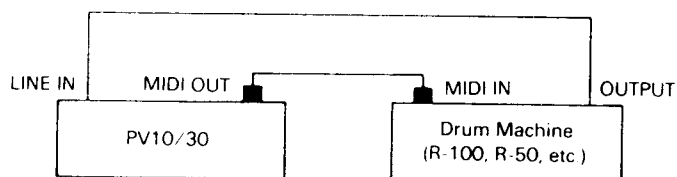

8. Other Functions

■ Tuning function

Using the tuning function, you can tune the digital piano to match another instrument.

1. Press the **PIANO 1**, **PIANO 2**, and **PIANO 3** switches, all at the same time, while holding down the **CHORUS** switch. This operation is the same as entering the MIDI programming mode.
2. Press the **E.PIANO 1** switch.

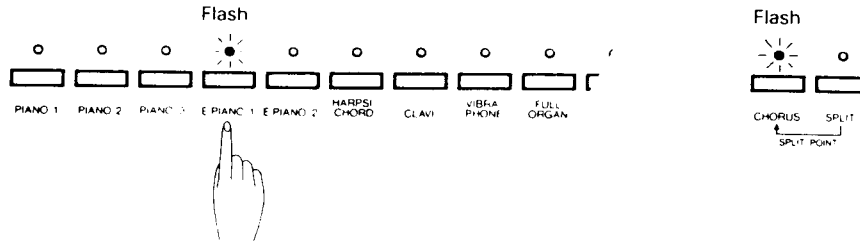

The **CHORUS** and the **E.PIANO 1** LEDs begin flashing, indicating that the digital piano entered the tuning mode.

Note:

When you press a key (except white and black keys for tuning) after entering the tuning mode, the tone set before the entry to this mode sounds. Use this tone for tuning with another instrument.

3. Press either the highest white or black key to tune up or down.

Each time the highest white key is pressed, the pitch increases gradually. When you press the highest black key, the pitch is lowered.

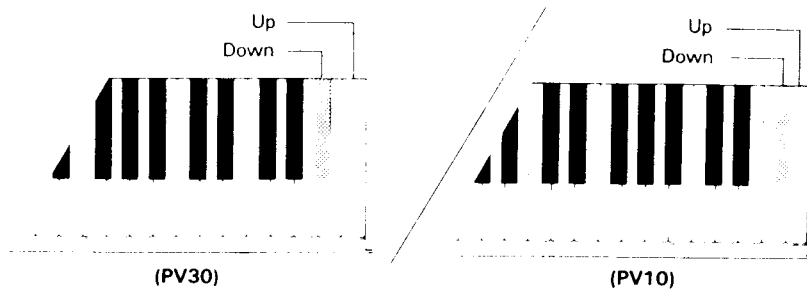

4. Press the **CHORUS** switch to quit the programming mode.

Note:

When the power is turned on again, the specially tuned pitch is canceled.

■ Transpose function

The transpose function allows you transpose easily without any difficult keyboard operation. Fingering remains the same.

Note:

This function is especially useful for accompaniment of singers or songs in another key.

1. Adjust with the **TRANPOSE** slide control with striking a key.

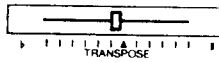

Down ← → Up

Note:

Transpose range is F# — F on the basis of C. One division on the TRANPOSE slide control corresponds to one semitone.

■ Assigning functions to the soft pedal

You can assign various functions to the soft pedal by following the proper procedure when the power is turned ON.

Note:

Connect the soft (left) and damper (right) pedals to the jacks at the back of the keyboard.

- **To use as a normal soft pedal**
Turn on the power as you would normally.
- **To use as a sostenuto pedal**
Turn on the power while stepping on the soft pedal.
The tone being output when the pedal is stepped on will be maintained.
- **To use as a RHYTHM section start/stop switch**
Turn on the power while holding down the START/STOP switch in the RHYTHM section.
- **To use as a fill in switch**
Turn on the power while holding down the FILL IN switch.
- **To use as an intro/ending switch**
Turn on the power while holding down the INTRO/ ENDING switch.

Chord Table

Major Chord

C	
C ⁺ (D ⁺)	
D	
E ⁺ (D ⁺)	
E	
F	
F ⁺ (G ⁺)	
G	
A ⁺ (G ⁺)	
A	
B ⁺ (A ⁺)	
B	

Minor Chord

Cm	
C ⁻ m (D ⁻ m)	
Dm	
E ⁻ m (D ⁻ m)	
Em	
Fm	
F ⁻ m (G ⁻ m)	
Gm	
A ⁻ m (G ⁻ m)	
Am	
B ⁻ m (A ⁻ m)	
Bm	

Seventh Chord

C ⁷	
C ⁷ ⁻ (D ⁷ ⁻)	
D ⁷	
E ⁷ (D ⁷ ⁻)	
E ⁷	
F ⁷	
F ⁷ ⁻ (G ⁷ ⁻)	
G ⁷	
A ⁷ ⁻ (G ⁷ ⁻)	
A ⁷	
B ⁷ (A ⁷ ⁻)	
B ⁷	

Minor Seventh Chord

Cm ⁷	
C ⁻ m ⁷ (D ⁻ m ⁷)	
Dm ⁷	
E ⁻ m ⁷ (D ⁻ m ⁷)	
Em ⁷	
Fm ⁷	
F ⁻ m ⁷ (G ⁻ m ⁷)	
Gm ⁷	
A ⁻ m ⁷ (G ⁻ m ⁷)	
Am ⁷	
B ⁻ m ⁷ (A ⁻ m ⁷)	
Bm ⁷	

Major Seventh Chord

C ^M 7	
C ^M 7 ⁻ (D ^M 7 ⁻)	
D ^M 7	
E ^M 7 ⁻ (D ^M 7 ⁻)	
E ^M 7	
F ^M 7	
F ^M 7 ⁻ (G ^M 7 ⁻)	
G ^M 7	
A ^M 7 ⁻ (G ^M 7 ⁻)	
A ^M 7	
B ^M 7 ⁻ (A ^M 7 ⁻)	
B ^M 7	

Diminish Chord

Cdim	
C ⁻ dim (D ⁻ dim)	
Ddim	
E ⁻ dim (D ⁻ dim)	
Edim	
Fdim	
F ⁻ dim (G ⁻ dim)	
Gdim	
A ⁻ dim (G ⁻ dim)	
Adim	
B ⁻ dim (A ⁻ dim)	
Bdim	

Augment Chord

Caug	
C [♯] aug (D [♯] aug)	
Daug	
E [♯] aug (D [♯] aug)	
Eaug	
Faug	
F [♯] aug (G [♯] aug)	
Gaug	
A [♯] aug (G [♯] aug)	
Aaug	
B [♯] aug (A [♯] aug)	
Baug	

Minor Seventh Flat Five Chord

Cm [♭] 5	
C [♯] m [♭] 5 (D [♯] m [♭] 5)	
Dm [♭] 5	
E [♯] m [♭] 5 (D [♯] m [♭] 5)	
E [♭] m [♭] 5	
Fm [♭] 5	
F [♯] m [♭] 5 (G [♯] m [♭] 5)	
Gm [♭] 5	
A [♯] m [♭] 5 (G [♯] m [♭] 5)	
Am [♭] 5	
B [♯] m [♭] 5 (A [♯] m [♭] 5)	
Bm [♭] 5	

Seventh Sus Four Chord

C [♭] sus4	
C [♯] 7sus4 (D [♯] 7sus4)	
D [♭] 7sus4	
E [♯] 7sus4 (D [♯] 7sus4)	
E [♭] 7sus4	
F [♭] 7sus4	
F [♯] 7sus4 (G [♯] 7sus4)	
G [♭] 7sus4	
A [♯] 7sus4 (G [♯] 7sus4)	
A [♭] 7sus4	
B [♯] 7sus4 (A [♯] 7sus4)	
B [♭] 7sus4	

Sus Four Chord

Csus4	
C [♯] 7sus4 (D [♯] 7sus4)	
Dsus4	
E [♯] 7sus4 (D [♯] 7sus4)	
E [♭] 7sus4	
F [♭] 7sus4	
F [♯] 7sus4 (G [♯] 7sus4)	
Gsus4	
A [♯] 7sus4 (G [♯] 7sus4)	
A [♭] 7sus4	
B [♯] 7sus4 (A [♯] 7sus4)	
Bsus4	

Nineth Chord

C9	
C [♯] 9 (D [♯] 9)	
D9	
E [♯] 9 (D [♯] 9)	
E [♭] 9	
F9	
F [♯] 9 (G [♯] 9)	
G9	
A [♯] 9 (G [♯] 9)	
A9	
B [♯] 9 (A [♯] 9)	
B9	

PV10/30 Specifications

	PV30	PV10
KEYBOARD	88 keys	76 keys
TONE COLORS	< Upper & Lower Tone > Piano 1, 2, 3, E Piano 1, 2, Harpsichord, Clavi, Vibraphone, Full Organ, Jazz Organ, Strings < Upper Tone > Guitar, Marimba, Flute, Clarinet, Brass < Lower Tone > Wood Bass, Electric Bass, Slap Bass, Synthe Bass, Tuba	
EFFECT	Chorus	
SPECIAL MODE	Split, Dual	
RHYTHM SECTION	Pops 1, 2, Disco, Dance, 8 Beat, 16 Beat, Shuffle 1, 2, Country 1, 2, Ballad 1, 2, Swing 1, 2, Bounce 1, 2, Salsa, Samba, Rhumba, Bossanova, Rock'n Roll 1, 2, Reggae 1, 2, Tango 1, 2, Heavy Rock 1, 2, Waltz, Jazz Waltz, March, Polka Variation, Tempo Variation, Auto Fill In, Fill In, Intro/Ending, Start/Stop, Sinc. Stat, Tempo, Rhythm Volume	
AUTO PLAY ORCHESTRA	On, Counter Melody Volume, Chord Volume, Bass Volume	
SEQUENCER	< Track 1 > Volume, Play, Rec. < Track 2 > Volume, Play, Rec. Merge 1-2, Repeat, Start/Stop, Pause < Data Storage > Save, Load, Card	
OTHER CONTROLS	Master Volume, Transpose, Split/Dual Balance, Split Point, Power Switch, Tune, MIDI Mode Setting (Multi Timbre)	
CONNECTORS	Headphone, Soft Pedal (Soft, Softenute, Start/Stop, Intro/Ending, Fill-in), Damper Pedal, MIDI (In, Out, Thru), Line IN (L (MONO), R), Input Level Switch (H/L), Line Out (L (MONO), R), Output Level Switch (H/L), Expression Pedal	
OUTPUT POWER	20W x 2	10W x 2
SPEAKERS	16cm x 2	
DIMENSIONS (WxDxH)	1,379 x 456 x 779 mm 54 5/16" x 17 15/16" x 30 11/16" (including stand)	1,214 x 456 x 779 mm 47 13/16" x 17 15/16" x 30 11/16" (including stand)
WEIGHT	47.5 kg 104.5 lbs. (including stand)	42.5 kg 93.5 lbs. (including stand)

MIDI Implementation Chart

Function ...	Transmitted	Recognized	Remarks
Basic Channel Default Changed	1 1—16	1 1—16	
Mode Default Messages Altered	3 × *****	1 1, 3* ×	* The default for the OMNI mode is ON. Specifying MIDI channels automatically turns it OFF.
Note Number : True voice	21—108 ¹⁾ 28—103 ²⁾ *****	0—127 15—113	
Velocity Note ON Note OFF	○ 9nH V=1—127 × 9nH V=0, 8nH	○ V=1—127 ×	
After Touch Key's Ch's	× ×	× ×	
Pitch Bender	×	×	
Control Change 64 66 67	○ ○ ○	○ × ○	Damper Sostenuto Soft Pedal
Prog Change : True #	○ 0—127 *****	○ 0—15	16—127=0
System Exclusive	×	×	
System : Song Pos Common : Song Sel : Tune	× × ×	× × ×	
System : Clock Real Time : Commands	○ ○ (Start, Stop)	× ×	
Aux Messages : Local ON/OFF : All Notes OFF : Active Sense : Reset	× ○ ○ ×	○ ○ ○ ×	
Notes	1) 15—113 The value depends on the TRANSPOSE setting (PV30). 2) 22—108 The value depends on the TRANSPOSE setting (PV10).		

Mode 1 : OMNI ON, POLY Mode 2 : OMNI ON, MONO
 Mode 3 : OMNI OFF, POLY Mode 4 : OMNI OFF, MONO

○ : Y
 × : N

KAWAI

Kawai Musical Instruments Manufacturing Co., Ltd.
200 Terajima-cho, Hamamatsu, Japan

Free Manuals Download Website

<http://myh66.com>

<http://usermanuals.us>

<http://www.somanuals.com>

<http://www.4manuals.cc>

<http://www.manual-lib.com>

<http://www.404manual.com>

<http://www.luxmanual.com>

<http://aubethermostatmanual.com>

Golf course search by state

<http://golfingnear.com>

Email search by domain

<http://emailbydomain.com>

Auto manuals search

<http://auto.somanuals.com>

TV manuals search

<http://tv.somanuals.com>