

Friendly Digital Piano Forte



PV35

KAWAI

WARNING: This equipment generates, uses, and can radiate radio frequency energy. If not installed and used in accordance with the instruction manual, it can cause interference to radio communications. The rules with which it must comply afford reasonable protection against interference when used in most locations. However, there can be no guarantee that such interference will not occur in a particular installation. If this equipment should be suspected of causing interference with other electronic devices, verification can be made by turning its power off and on. If this equipment does appear to be the source of the interference, you should try to correct the interference by one or more of the following measures:

- reorient the receiving antenna.
- move the receiver away from the digital piano.
- plug the digital piano into a different outlet so that digital piano and receiver are on different branch circuits.
- consult the dealer or an experienced radio television technician.

This digital piano should be not commercial use but household use.

"This instrument has been certified to comply with the limits for a class B digital apparatus, pursuant to the Radio Interference Regulations, C.R.C., c. 1374."

OBS! Nätkabeln är speciell. Var vänlig kontakta auktoriserad KAWAI återförsäljare vid byte av nätkabeln.

IMPORTANT SAFETY INSTRUCTIONS

WARNING – When using electric products, basic precautions should always be followed, including the following:

1. Read all the instructions before using the product.
2. To reduce the risk of injury, close supervision is necessary when a product is used near children.
3. Do not use this product near water – for example, near a bathtub, washbowl, kitchen sink, in a wet basement, or near a swimming pool, or the like.
4. Do not touch the power plug with wet hands. There is a risk of electrical shock. Treat the power cord with care as well. Stepping on or tripping over it can break or short-circuit the wire inside.
5. This product should be used only with a cart or stand that is recommended by the manufacturer.
6. This product, either alone or in combination with an amplifier and headphones or speakers, may be capable of producing sound levels that could cause permanent hearing loss. Do not operate for a long period of time at a high volume level or at a level that is uncomfortable. If you experience any hearing loss or ringing in the ears, you should consult an audiologist.
7. The product should be located so that its location or position does not interfere with its proper ventilation.
8. The product should be located away from heat sources such as radiators, heat registers, or other products that produce heat.
9. Keep the instrument away from electrical motors, neon signs, fluorescent light fixtures, and other sources of electrical noise.
10. The product should be connected to a power supply only of the type described in the operating instructions or as marked on the product.
11. This product may be equipped with a polarized line plug (one blade wider than the other). This is a safety feature. If you are unable to insert the plug into the outlet, contact an electrician to replace your obsolete outlet. Do not defeat the safety purpose of the plug.
12. Always turn the power off when the instrument is not in use. The power-supply cord of the product should be unplugged from the outlet when left unused for a long period of time.
13. Care should be taken so that objects do not fall and liquids are not spilled into the enclosure through openings.
14. The product should be serviced by qualified service personnel when:
 - A. The power-supply cord or the plug has been damaged; or
 - B. Objects have fallen, or liquid has been spilled into the product; or
 - C. The product has been exposed to rain; or
 - D. The product does not appear to operate normally or exhibits a marked change in performance; or
 - E. The product has been dropped, or the enclosure damaged.
15. Do not attempt to service the product beyond that described in the user-maintenance instructions. All other servicing should be referred to qualified service personnel.

SAVE THESE INSTRUCTIONS

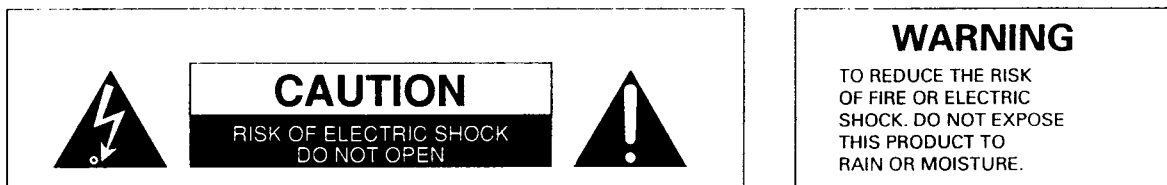

AVIS: RISQUE DE CHOC ELECTRIQUE

-NE PAS OUVRIR.

CAUTION: TO REDUCE THE RISK OF ELECTRIC SHOCK, DO NOT REMOVE COVER (OR BACK). NO USER-SERVICEABLE PARTS INSIDE. REFER SERVICING TO QUALIFIED SERVICE PERSONNEL.



The lightning flash with arrowhead symbol, within an equilateral triangle, is intended to alert the user to the presence of uninsulated "dangerous voltage" within the product's enclosure that may be of sufficient magnitude to constitute a risk of electric shock to persons.



The exclamation point within an equilateral triangle is intended to alert the user to the presence of important operating and maintenance (servicing) instructions in the literature accompanying the product.

Introducing the PV35

Contents

Introducing the PV35

Part One: Playing the PV35

1. Let's Play a Few Notes1 – 2
2. Combining Tones (DUAL Mode)1 – 5
3. Playing Two Tones Independently (SPLIT Mode)1 – 6
4. Introducing the Rhythm Section.....1 – 9
5. The Rest of the Band (AUTO ACCOMPANIMENT)1 – 12
6. Adding Some Dynamics (ARRANGEMENT EXPANDER Dial)1 – 15
7. Ad-Libbing It (ONE FINGER AD-LIB).....1 – 16
8. Advanced Ad-Libbing.....1 – 17
9. Sweet Harmony (AUTO MELODY CHORD).....1 – 18
10. Join the Drum Section (HAND PERCUSSION)1 – 19

Part Two: Recording Your Songs

1. How to Handle Floppy Disks2 – 2
2. Let's Listen to Some Music2 – 4
3. Adding New Rhythm Patterns2 – 7
4. Recording Your Songs2 – 9
5. Recording the Right and Left Hands Separately2 – 13
6. Recording With More Than One Tone2 – 16
7. Playing Back Individual Tracks2 – 18

Part Three: Getting the Most Out of Your PV35

1. Changing Keys (TRANSPOSE)3 – 2
2. File Tuning (TUNE, TUNING CURVE)3 – 3
3. Putting Your Foot Down (PEDAL ASSIGN)3 – 5
4. Adjusting the Acoustic (REVERB MODE)3 – 8
5. Saving Your Settings (REGISTRATION MEMORY).....3 – 9
6. Storing Registrations on a Disk (REGIST. SAVE)3 – 11
7. Loading Registrations Into the PV35 (REGIST. LOAD)3 – 13

Part Four: Using Floppy Disks

1. Preparing Disks for Use (FORMAT)4 – 2
2. Listing the Songs on a Disk (LIST)4 – 4
3. Listing Registration Sets (REGIST. LIST).....4 – 6
4. Naming Songs (NAME)4 – 8
5. Naming Registration Sets (REGIST. NAME)4 – 11
6. Removing Songs from a Disk (DELETE)4 – 13
7. Copying Songs (COPY).....4 – 15

Part Five: Making the MIDI Connection

1. An Overview of MIDI.....5 – 2
2. Selecting the Basic Channel5 – 6
3. Sending and Receiving Program Numbers.....5 – 7
4. Using the MULTI TIMBRE Mode.....5 – 11
5. Switching Local Control On and Off5 – 13
6. Recording MIDI data (MULTI-REC).....5 – 14

Appendices

Panel Buttons and Controls

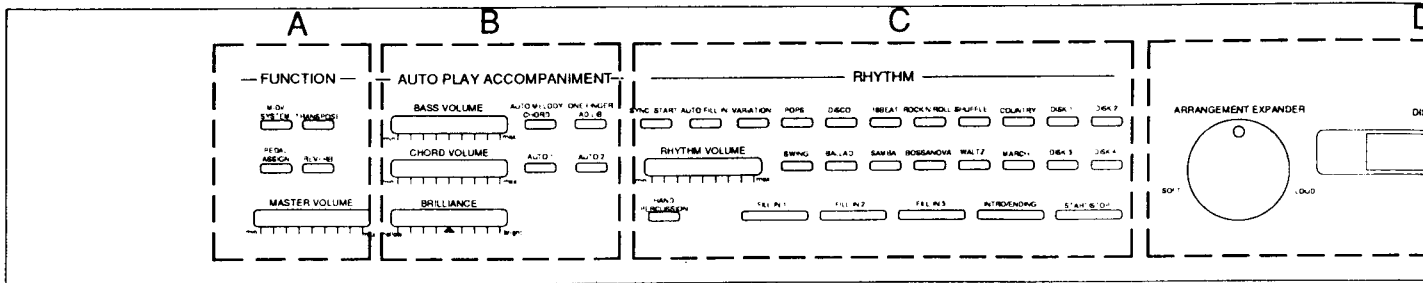

A. FUNCTION Controls

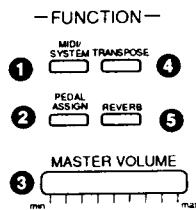

- ① **MIDI/SYSTEM** button
Changes the PV35's tuning and MIDI function settings.
- ② **PEDAL ASSIGN** button
Assigns various functions to the left and damper pedals.
- ③ **MASTER VOLUME** slider
Adjusts the overall volume of the PV35.
- ④ **TRANSPOSE** button
Adjusts the pitch in half-tone steps.
- ⑤ **REVERB** button
Adds reverb to the PV35's sound. You can select from seven different types of reverb.

B. AUTO PLAY ACCOMPANIMENT Controls

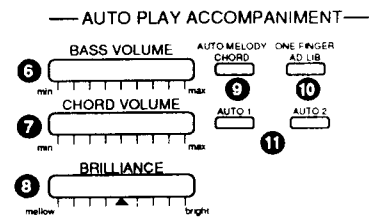

- ⑥ **BASS VOLUME** slider
Adjusts the volume of the bass sound.
- ⑦ **CHORD VOLUME** slider
Adjusts the volume of the chord sound.
- ⑧ **BRILLIANCE** slider
Adjusts the overall brilliance of sound from the PV35.
- ⑨ **AUTO MELODY CHORD** button
Adds automatic chords to single-note melody lines.
- ⑩ **ONE FINGER AD LIB** button
Lets you play ad-lib phrases matched to the rhythm with the press of a single key.
- ⑪ **AUTO 1** and **AUTO 2** buttons
Select one of two AUTO ACCOMPANIMENT modes.

Introducing the PV35

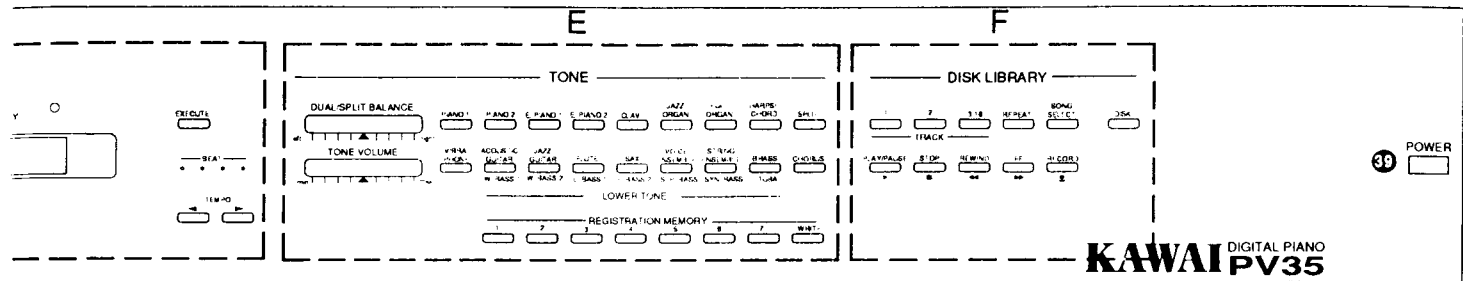

C. RHYTHM Controls

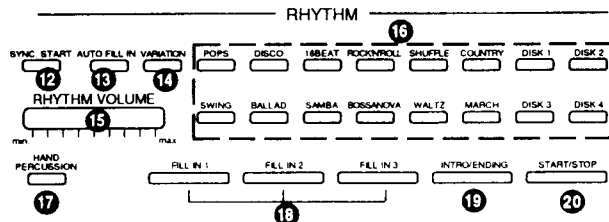

- ⑫ **SYNC. START** button
Lets you start the PV35's rhythm section playing at the moment you touch the keyboard.
- ⑬ **AUTO FILL IN** button
Plays an automatic fill-in pattern every fourth measure.
- ⑭ **VARIATION** button
Selects variation patterns for the preset rhythms, or disk rhythm patterns 5 through 8.
- ⑮ **RHYTHM VOLUME** slider
Adjusts the volume of the PV35's rhythm sounds.
- ⑯ **RHYTHM** buttons
Select one of the PV35's internal rhythms or disk rhythms.
- ⑰ **HAND PERCUSSION** button
Lets you play rhythm and percussion sounds from the PV35 keyboard.
- ⑱ **FILL IN 1, FILL IN 2, and FILL IN 3** buttons
Play three different fill-in patterns matching the rhythm and AUTO ACCOMPANIMENT selections.

⑲ INTRO/ENDING button

Starts the rhythm with an intro pattern when the rhythm section is stopped, or stops a rhythm that is playing with a smart ending pattern.

⑳ START/STOP button

Starts rhythm play when the rhythm section is stopped, or stops it when it is playing.

D. ARRANGEMENT EXPANDER Dial, DISPLAY, and Miscellaneous Controls

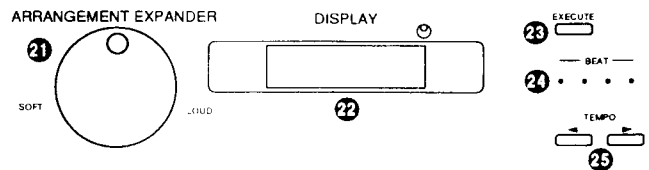

- ⑳ **ARRANGEMENT EXPANDER** dial
Varies the rhythm and AUTO ACCOMPANIMENT patterns. Also used to make value settings in the PV35's various setting modes.
- ㉑ **DISPLAY**
Displays the names of rhythms and songs, as well as values set in the PV35's various setting modes.
- ㉒ **EXECUTE** button
Selects setting modes and executes value settings.

- ②4 **BEAT** lamps
Flash in time with the selected rhythm tempo.
- ②5 **TEMPO** buttons
Adjust the rhythm section tempo. Also used to make value settings in the PV35's various setting modes.

E. TONE Controls

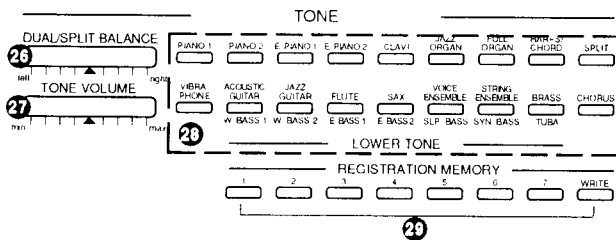

- ②6 **DUAL/SPLIT BALANCE** slider
Adjust the balance between tones in DUAL and SPLIT modes.
- ②7 **TONE VOLUME** slider
Adjusts the volume of the tone you select using the TONE buttons.
- ②8 **TONE** buttons
Select the tones for the melody line. Tone names listed beneath the TONE buttons can be selected for the lower keyboard in SPLIT mode.
- ②9 **REGISTRATION MEMORY** buttons
Store the PV35's tone, rhythm, volume, and other settings as a registration, which can be called up with the touch of a single button.

F. DISK LIBRARY Controls

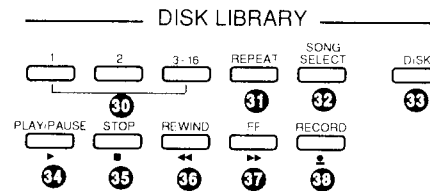

- ③0 **TRACK** buttons
Select recording tracks, letting you record the left-hand and right-hand parts of a song, as well as parts for individual tones, on separate tracks.
- ③1 **REPEAT** button
Plays a song repeatedly.
- ③2 **SONG SELECT** button
Selects one of the songs which have been recorded to a floppy disk.
- ③3 **DISK** button
Selects the PV35 disk mode.
- ③4 **PLAY/PAUSE** button
Plays back a song, or pauses a song that is playing.
- ③5 **STOP** button
Stops a song that is playing.
- ③6 **REWIND** button
Rewinds a song at high speed.
- ③7 **FF** button
Advances a song at high speed.
- ③8 **RECORD** button
Starts the recording of a song.
- ③9 **POWER** switch
Turns the PV35's power on and off.

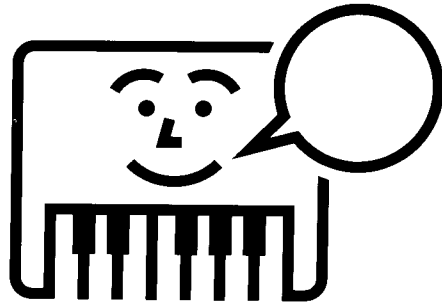

Thank you!

. . .for purchasing the KAWAI PV35 Digital Piano Forte

The KAWAI PV35 is an innovative digital keyboard which combines the latest electronic technologies with KAWAI's long-accumulated expertise in the creation of fine musical instruments.

The features of the PV35 include a full range of accompaniment functions, such as: 32 rhythm patterns (24 internal plus 8 disk patterns); AUTO ACCOMPANIMENT, which gives you automatic bass and chord accompaniment in response to chords you finger on the keyboard; ONE FINGER AD-LIB, which lets you play a variety of ad-lib phrases with the touch of a single key; an AUTO MELODY CHORD function, which adds chords to your single-note melodies; and an ARRANGEMENT EXPANDER Dial which gives you access to eight variations for each rhythm and AUTO ACCOMPANIMENT pattern. Taken together, these features will allow you to enjoy finely detailed performances in a variety of musical genres.

What's more, the PV35's floppy disk drive lets you record songs of up to 16 tracks each using sophisticated multi-track recording techniques. You can store up to 100 recorded songs on a single floppy disk.

Finally, the PV35 conforms to the international MIDI standard for digital instruments. This feature allows you to connect the PV35 to other instruments with MIDI jacks to create digital ensembles, for musical performances of even greater variety.

This manual describes the PV35 and explains how you can make use of its many advanced features. Please read the manual carefully as you learn how to play the PV35, and then be sure to keep it handy for future reference.

PART ONE

PLAYING THE PV35

To enjoy playing your KAWAI keyboard. . .

The PV35 gives you 24 different internal rhythms and a variety of disk rhythms to enjoy playing along with. A full range of functions, from DUAL and SPLIT modes to AUTO ACCOMPANIMENT and ONE FINGER AD-LIB, puts the capacity for polished ensemble performances right at your fingertips. You can even choose from eight variations for each rhythm and accompaniment pattern, greatly extending the variety of your performances!

But before we get to these more complicated features, let us begin with a quick explanation of the PV35's most basic functions. . .

CHAPTER 1 Let's Play a Few Notes

This chapter shows you how to prepare the PV35 for playing, and introduces the keyboard's most basic features.



Begin by inserting the plug of the PV35 into an electrical outlet.

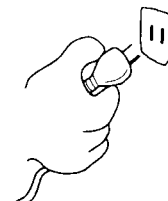

Press the **POWER** switch located in the lower right corner of the control panel.

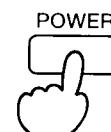

When you turn the power on, the following message will appear in the display screen for several seconds:

Then the standard display will appear. This display shows the currently selected tone name and arrangement number in the upper line, and the rhythm name and tempo in the lower line.

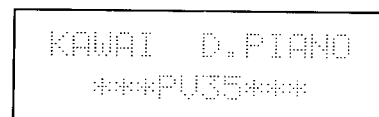

- a. Tone name : PIANO1
- b. Arrangement number : 4
- c. Rhythm name : POPS
- d. Tempo : J=120

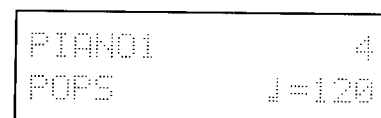

The tone PIANO 1, arrangement number 4, the rhythm POPS, and a tempo of 120 are selected automatically each time the PV35's power switch is turned on. These settings are known as default settings.



Adjust the volume using the **MASTER VOLUME** slider.

The **MASTER VOLUME** slider controls the overall volume of the PV35. This includes the volume of tones played using the keyboard as well as accompaniment sounds.

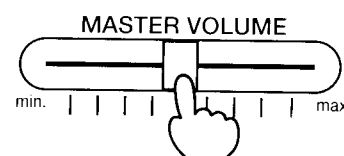

Let's Play a Few Notes

4

Try pressing one of the **TONE** buttons.
The lamp on the button you press will light up. . .



. . .and the name of the tone which you have selected will appear in the display screen.

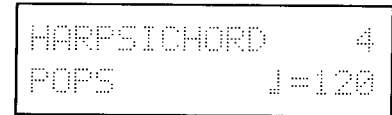

5

Adjust the volume of the tone using the **TONE VOLUME** slider.

The **TONE VOLUME** slider controls only the volume of tones played using the keyboard.

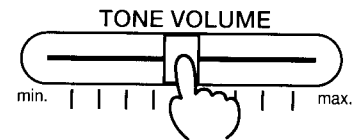

Moving this slider all the way to the left will turn the tone volume off, so that no sound will be heard when the keyboard is played.

*Remember that the **MASTER VOLUME** slider controls the overall volume of the PV35. Tones played using the keyboard will sound quiet regardless of the **TONE VOLUME** setting, if the **MASTER VOLUME** slider is set at a low position.*

6

Now play a few notes on the keyboard.

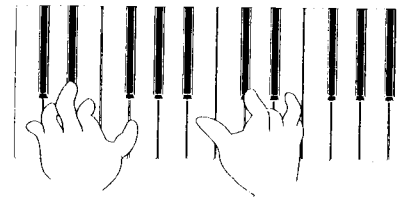

You will hear the sound of the tone you selected in the preceding STEP. Try selecting and playing a few other tones, to get a feel for the broad range of musical expression which the PV35 offers.

Playing the PV35



Try adding some effects to your favorite tone.

- Chorus

Press the **CHORUS** button. The lamp on this button will light up, and the notes you play on the keyboard will have a richer sound.



Press the **CHORUS** button again to turn the effect off.



The chorus effect alters the sound of keyboard tones only.

- Brilliance

Move the **BRILLIANCE** slider to the right or left. The sound of notes you play will become brighter as you move this slider to the right, and more mellow as you move it to the left.

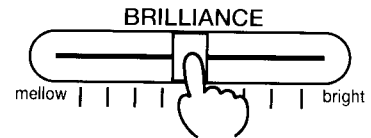

The brilliance control affects all of the sounds produced by the PV35, including the rhythm and accompaniment sounds as well as the keyboard tones.

CHAPTER 2 Combining Tones (DUAL Mode)

The PV35 features a DUAL mode, which allows you to play two tones simultaneously with each press of a key.

1

Select the two tones you wish to combine for dual play.

Press the **TONE** buttons which correspond to these two tones simultaneously.

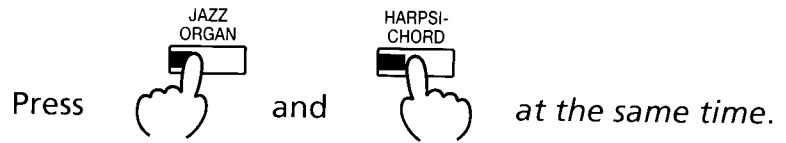

The lamps of the buttons will light up, and the names of the tones you have selected will appear in the upper line of the display screen, separated by a plus sign.

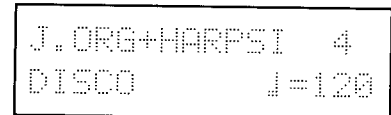

2

Play a few notes.

You should hear both of the tones you selected in the preceding STEP, playing in unison.

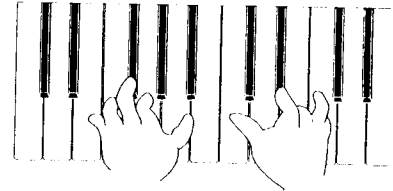

Adjust the balance of the tones with respect to each other using the **DUAL/SPLIT BALANCE** slider.

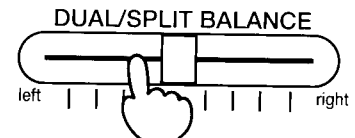

The tone listed to the left in the display screen will grow louder as you move the slider to the left. The tone listed to the right will grow louder as you move the slider to the right.

3

To leave DUAL mode, simply press any single **TONE** button to select a new tone.

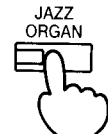

CHAPTER 3

Playing Two Tones Independently (SPLIT Mode)

The PV35 keyboard can be divided into left and right halves, known respectively as the upper and lower keyboards. SPLIT mode lets you assign a different tone to each of these keyboards, so you can play a melody with your right hand while fingering chords or a bass line with your left. . . using different tones for each!



Press the **SPLIT** button.

The lamp on that button will light up. . .

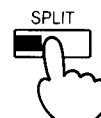

. . . and the names of the tones assigned to the upper and lower keyboards will appear in the upper line of the display screen, separated by a colon.

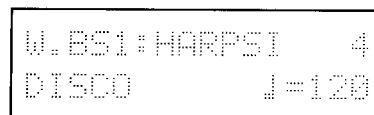

*The currently selected tone will be assigned to the upper keyboard, and its name will appear to the right of the colon. For the lower keyboard the default tone, WOOD BASS 1, will automatically be selected. The name of this tone will appear to the left of the colon, and the lamp on the corresponding **TONE** button will light up.*



To change the upper keyboard tone, simply press the **TONE** button corresponding to the desired tone.

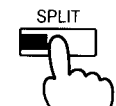

To change the tone assigned to the lower keyboard, press the button which corresponds to the desired tone while holding down the **SPLIT** button.

Press  and  at the same time.

Playing Two Tones Independently

You have probably noticed that seven of the buttons in the lower row of **TONE** buttons are labeled with two different tone names each. The tones indicated by the labels beneath the buttons — the bass and tuba tones — are for use exclusively with the lower keyboard in **SPLIT** mode. To select one of these tones, press the appropriate button once while holding down the **SPLIT** button. To assign one of the tones indicated by labels above the buttons to the lower keyboard, press the button twice.

- (1) Press once to select the tone named in the label under the button — in this case, **WOOD BASS 1**.

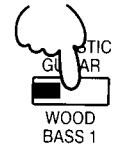

- (2) Press twice to select the tone named in the label over the button — **ACOUSTIC GUITAR**, here.



*The pitch of any tone other than a bass or tuba tone will rise one octave when selected for the lower keyboard in **SPLIT** mode.*

Adjust the balance of the tones with respect to each other using the **DUAL/SPLIT BALANCE** slider.

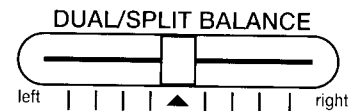

The tone assigned to the lower keyboard will grow louder as you move the slider to the left, whereas the upper keyboard tone will become louder as you move the slider to the right.



To change the split point (the dividing point between the upper and lower keyboards) . . .

- (1) Press the **MIDI/SYSTEM** button.

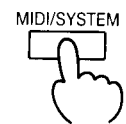

*If you don't do anything for several seconds, the PV35 will automatically leave **MIDI/SYSTEM** mode.*

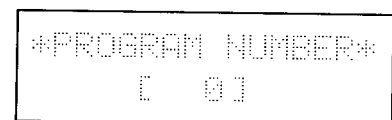

The ***SPLIT POINT*** is displayed by pressing the ◀ and ▶ buttons.

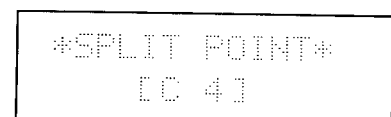
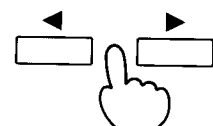

Playing the PV35

- (2) Set the split point using the **ARRANGEMENT EXPANDER** dial or by pressing the appropriate key on the keyboard.

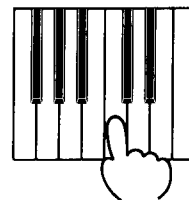

The key name in the display will be the lowest note of the upper keyboard.



SPLIT POINT
[C 4]

- (3) Press the **MIDI/SYSTEM** button. The split point is now set.

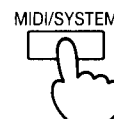

The split point will return to its original location (the C4 key of the keyboard) when the PV35's power is turned off.



To leave SPLIT mode, press the **SPLIT** button. The lamp on the split button will go out.

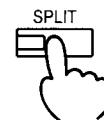

CHAPTER 4 Introducing the Rhythm Section

In the first three chapters we have shown you some of the wonderful things you can do with the keyboard of your KAWAI PV35. Now, we would like to introduce you to a slightly different feature of the PV35: rhythm accompaniment.



Press one of the **RHYTHM** buttons. The lamp on the button you press will light up. . .



. . .and the name of the rhythm pattern which you have selected will appear in the display screen.

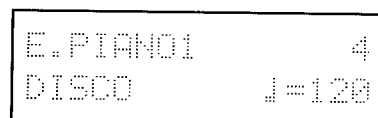

If you wish, you can select a variation of the rhythm pattern you have chosen by pressing the **VARIATION** button.



Now it's time to start the rhythm section playing.

There are four ways to do this:

- Normal start (**START/STOP** button)

Press the **START/STOP** button to start the rhythm.



- Synchronized start (**SYNC. START** button)

Press the **SYNC. START** button while the rhythm is stopped. The lamp on the button will light up, indicating that the PV35 is ready to start playing a rhythm pattern.



Now, press any key on the keyboard. The rhythm pattern will begin playing the moment you play a note!

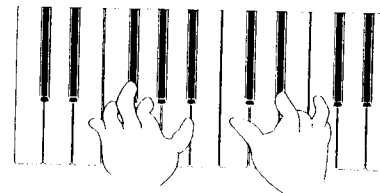

Use the synchronized start function when you want the rhythm to begin playing together with the melody.

- Intro start (**INTRO/ENDING** button)

Press the **INTRO/ENDING** button while the rhythm is stopped. A one-measure intro pattern will play, followed by the rhythm pattern you have selected.

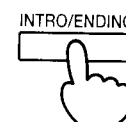

Playing the PV35

- Sync/intro start

The synchronized start and intro features can be combined. Press the **SYNC. START** button, then the **INTRO/ENDING** button. The intro pattern will start the moment you begin to play. As with the intro start above, it will be followed by the rhythm pattern you have selected.

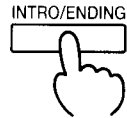
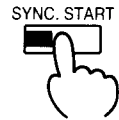

Try playing along with the rhythm. The four lamps above the **TEMPO** buttons blink to show you the beat: the leftmost lamp blinks on beat one, the lamp to its right blinks on beat two, and so on. (These lamps are known as the **BEAT** lamps, by the way.)

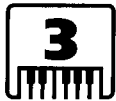
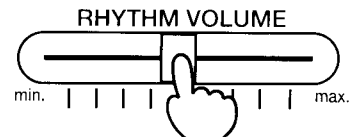
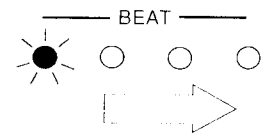
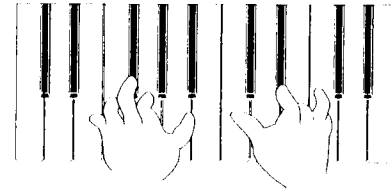

Adjust the volume of the rhythm section using the **RHYTHM VOLUME** slider.



Remember that the **MASTER VOLUME** slider controls the overall volume of the PV35. The rhythm section will sound quiet regardless of the **RHYTHM VOLUME** setting, if the **MASTER VOLUME** slider is set at a low position.



Adjust the tempo using the **TEMPO** (◀ and ▶) buttons.

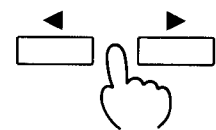

Slower or Faster

The change of tempo will be reflected in the display screen.

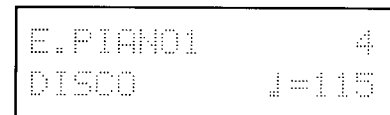

The tempo will increase or decrease by one beat with each press of a **TEMPO** button. To change the tempo by larger amounts, press and hold the appropriate **TEMPO** button. The tempo will increase or decrease in steps of ten beats at a time.

You can set the tempo anywhere from a minimum of 40 to a maximum of 250 beats per minute.

Introducing the Rhythm Section

5

Now that you are playing comfortably along with the rhythm, let's try adding a little variety.

There are two ways you can vary the rhythm pattern as you play:

- Fill-in patterns (**FILL IN** buttons)

If you press one of the **FILL IN** buttons while the rhythm pattern is playing, the rhythm will change. This is known as a fill-in pattern.

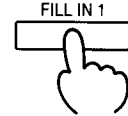

The PV35 provides you with three fill-in patterns for each rhythm, corresponding to the **FILL IN 1**, **FILL IN 2**, and **FILL IN 3** buttons. You can add spice to a performance by timing these fill-in patterns to play at a song's transition points.

- Automatic fill in (**AUTO FILL IN** button)

The PV35 can add the fill-in patterns for you, automatically. Just press the **AUTO FILL IN** button.



The lamp on the button will light up to show that the automatic fill in function is on. When the rhythm is started, the PV35 will play a fill-in pattern on every fourth measure. The first three of these will use the **FILL IN 2** pattern, the next uses the **FILL IN 1** pattern once to round out the standard 16 bar verse or chorus, and then the cycle repeats.



*Another exciting way to vary the rhythm during a performance is to change the rhythm pattern altogether. You can select a new rhythm while you are playing by simply pressing a **RHYTHM** button as described in STEP 1. The change will take place during the following measure. Keep in mind that good timing is important for a smooth transition!*

6

There are two ways to stop the rhythm section.

- Normal stop (**START/STOP** button)

Press the **START/STOP** button to stop the rhythm section instantly.

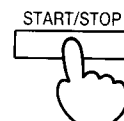

- Ending pattern (**INTRO/ENDING** button)

When you press this button an ending pattern will play, following which the rhythm section will stop. You can use this feature to bring your performance to a smart finish.

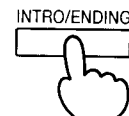

CHAPTER 5

The Rest of the Band

(AUTO ACCOMPANIMENT)

The PV35's AUTO ACCOMPANIMENT function allows you to play a full accompaniment that matches the rhythm you've selected — simply by playing a chord!



Begin by selecting a rhythm, as explained in Chapter 4. (Please refer to page 1 – 9.)



Now choose an AUTO ACCOMPANIMENT mode.

The PV35 offers you the two AUTO ACCOMPANIMENT modes described below:

- AUTO 1 mode (**AUTO 1** button)

This mode lets you accompany yourself with bass and chord patterns, simply by playing and holding a chord on the lower keyboard.

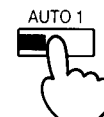

- AUTO 2 mode (**AUTO 2** button)

This mode produces bass and chord patterns in response to chords played anywhere on the keyboard. In addition, the bass pattern will vary depending on the lowest note played within the lower keyboard.

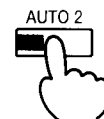

The “lower keyboard” in the paragraphs above refers to the original lower keyboard, which includes all keys below the point labeled SPLIT POINT on the keyboard. The range of the lower keyboard used by the AUTO ACCOMPANIMENT function will not be affected if you change the split point for the SPLIT mode, as described in Chapter 3.

Press either the **AUTO 1** button or the **AUTO 2** button to select an AUTO ACCOMPANIMENT mode.

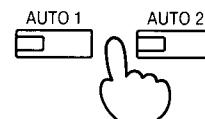

The lamp on the button you press will light up.



Start the rhythm section, using one of the four methods described in Chapter 4. (Please refer to page 1 – 9.)

The Rest of the Band

4

Now, start playing!

The accompaniment will begin playing when you do. Notice how the chord patterns change in response to the chords you play.

(The chords recognized by the PV35 are listed in the Chord Forms chart in Appendix B of this manual. Please refer to page AP. – 2.)

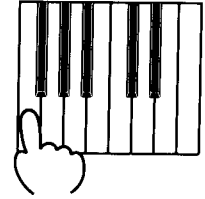

E.PIANO1	4
F M&J	J=115

Try experimenting with both AUTO ACCOMPANIMENT modes. The chart below should help you to get a better idea of the difference between these modes.

	AUTO 1	AUTO 2
	<i>for those accustomed to organ and jazz piano playing</i>	<i>for those accustomed to contemporary piano playing</i>
Chord detection	Lower keyboard	Whole keyboard
Bass detection	Lower keyboard	Whole keyboard (bass pattern root detected on lower keyboard)
Detection method	Chords detected when keyboard is played	Chords detected when three or more notes played
Keyboard tones	No tones produced by lower keyboard (except in SPLIT mode).	Tones produced by entire keyboard

Be sure to try adding fill-in rhythm patterns as you play. The accompaniment will change along with the rhythm, for some catchy transitions.

5

Adjust the chord and bass volume levels using the sliders.

- Chord volume (**CHORD VOLUME** slider)

The **CHORD VOLUME** slider controls only the volume of chord patterns.

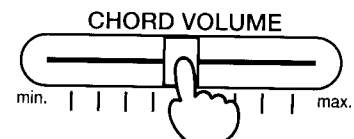

- Bass volume (**BASS VOLUME** slider)

The **BASS VOLUME** slider controls only the volume of bass patterns.

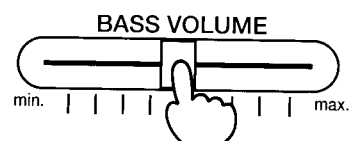

Playing the PV35



Moving either of these sliders all the way to the left will turn the corresponding volume level off, eliminating the chord or bass pattern sounds from the AUTO ACCOMPANIMENT.

Remember that the **MASTER VOLUME** slider controls the overall volume of the PV35. The bass and chords will be low volume regardless of the **BASS VOLUME** and **CHORD VOLUME** settings if the **MASTER VOLUME** slider is set low.



You might find the bass patterns and bass tone selections provided by the AUTO ACCOMPANIMENT feature to be too limiting. To get around this problem, you might want to add only the chord patterns while playing your own bass line, using any bass tone you desire. Try the following method:

(1) Press the **SPLIT** button and select the bass tone you wish to use for the lower keyboard.

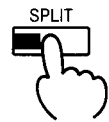

(2) Press the **AUTO 2** button.

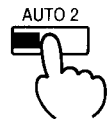

(3) Move the **BASS VOLUME** slider all the way to the left to turn off the AUTO ACCOMPANIMENT bass pattern.

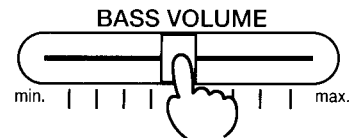

(4) Play a bass line with your left hand, and finger chords as you play with your right hand.



When you're done playing, stop the rhythm section as described in Chapter 4. (Please refer to page 1 – 11.)

The AUTO ACCOMPANIMENT will stop together with the rhythm section.



Press the **AUTO** button you selected in STEP 2 above to turn off the AUTO ACCOMPANIMENT function.

The lamp on that button will go out.

CHAPTER 6 Adding Some Dynamics (ARRANGEMENT EXPANDER Dial)

Every song has a dynamic flow, becoming louder and more exciting in some places and quieter in others. Songs can therefore become monotonous if played with the same rhythm and accompaniment patterns throughout. The PV35's **ARRANGEMENT EXPANDER** dial allows you to vary the rhythm and AUTO ACCOMPANIMENT you select, making it louder or softer as needed.

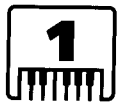
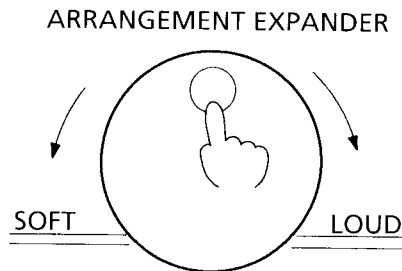

Start the rhythm section and AUTO ACCOMPANIMENT, using one of the four methods described in Chapter 4. (Please refer to page 1 – 9.)



Turn the **ARRANGEMENT EXPANDER** dial.



The arrangement number in the upper right hand corner of the display screen will change as you do so.

The arrangement number will increase as you turn the dial to the right, and the rhythm and accompaniment sections will become louder and more exciting. As you turn the dial to the left, the number will decrease, and the rhythm and accompaniment will become softer.

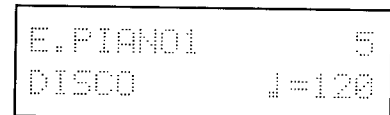

There are a total of eight arrangement levels, numbered 1 through 8. Try changing the intonation as you play, to add a dynamic aspect to your performance.

CHAPTER 7

Ad-Libbing It (ONE FINGER AD-LIB)

By now you've become quite good at using the rhythm and AUTO ACCOMPANIMENT features to back up your melody. So good, in fact, that the melody has begun to pale in comparison. Well, ONE FINGER AD-LIB may be just what you are looking for! This handy function lets you play a variety of exciting ad-lib phrases that match the rhythm you have selected — with the touch of a single key!



Now press the **ONE FINGER AD-LIB** button.

The lamp on the button will light up, indicating that the ONE FINGER AD-LIB function is on.



Press and hold one of the keys on the ONE FINGER AD-LIB keyboard. An ad-lib phrase will play in time with the selected rhythm pattern.

Each of the keys in the ad-lib keyboard produces a different phrase and tone when pressed while the ONE FINGER AD-LIB function is turned on.

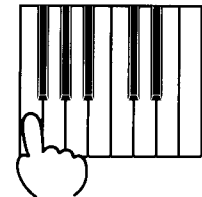

The ad-lib phrase begins playing the instant you press a key, so you can match the timing of the ad-lib to the melody you are playing.

You can change the range of the ONE FINGER AD-LIB keyboard using the split point function. (For details regarding SPLIT mode, please refer to page 1 – 6.)



Now try fingering a chord on the lower keyboard while the ad-lib phrase is playing. The ad-lib phrase will change key automatically to match the chord you play.



The PV35 uses a different preset tone to play each ad-lib phrase. You can select a different tone by pressing one of the TONE buttons while the ad-lib phrase is playing.

Once you have changed the ad-lib preset tone in this manner, you must turn either the ONE FINGER AD-LIB function or the PV35's power supply off and then on again to restore the ad-lib preset tone.



Press the **ONE FINGER AD-LIB** button again to turn the ONE FINGER AD-LIB function off.

The lamp on the button will go out.



CHAPTER 8 Advanced Ad-Libbing

The PV35 lets you play along with an automatic chord progression suited to the selected rhythm when the **AUTO ACCOMPANIMENT** and **ONE FINGER AD-LIB** functions are selected together. Try this using the following procedure:



Press the **AUTO 1** button to select **AUTO ACCOMPANIMENT** mode 1.

The lamp on the button will light up.

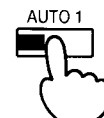

Play a major or minor chord on the keyboard to tell the PV35 which key to begin the chord progression in. (If you skip this step, the PV35 will play a progression in the key of C major.)



Press the **ONE FINGER AD-LIB** button.



Start the rhythm and auto accompaniment by pressing either the **START/STOP** button or the **INTRO/ENDING** button.

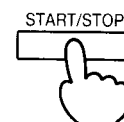

The PV35 will begin to play a rhythm pattern and chord progression in the key corresponding to the chord you played.

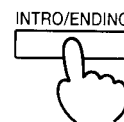

Now press and hold one of the keys on the **ONE FINGER AD-LIB** keyboard.

An ad-lib phrase will begin to play, changing constantly to match the chord progression you have selected. This handy feature allows you to play intricate melodies with one finger of your right hand.

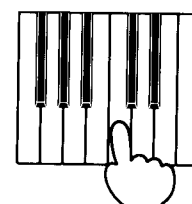

If you played a major chord in STEP 2, the PV35 will play a chord progression in a major key. If you played a minor chord, you will hear a chord progression in a minor key.

*If you would like to use the **AUTO ACCOMPANIMENT** and **ONE FINGER AD-LIB** functions together, but do not want the PV35 to play an automatic chord progression, skip STEP 3 above and play a chord after STEP 4. Any ad-lib phrases played will change to match the chords you finger.*



Press the **ONE FINGER AD-LIB** button again when you want to turn the **ONE FINGER AD-LIB** function off.

CHAPTER 9 Sweet Harmony (Auto Melody Chord)

The PV35's AUTO MELODY CHORD function adds two harmony notes to the lowest note played on the upper keyboard. The notes played vary to match the chords you play on the lower keyboard. This feature allows you to play melody chords with a single finger!



Press the **AUTO MELODY CHORD** button.

The lamp on the button will light up. The keyboard is now divided into upper and lower halves, as with the SPLIT function.

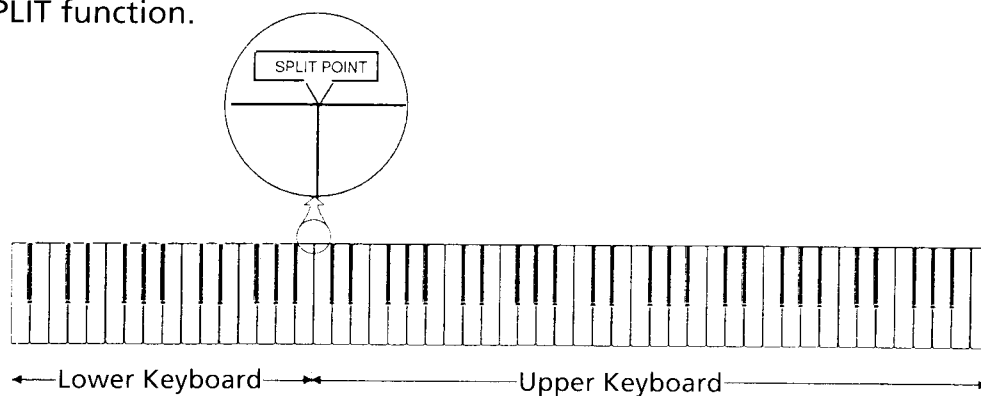

Press and hold a chord on the lower keyboard, and play a few notes on the upper keyboard.

Even if you play just one note at a time with your right hand, the PV35 will sound as though you were playing three-finger chords!

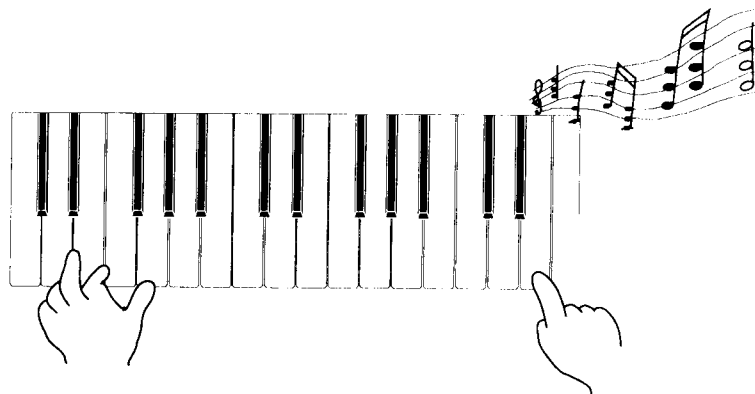

Press the **AUTO MELODY CHORD** button again when you want to turn this function off. The light on the button will go out.



The AUTO MELODY CHORD and ONE FINGER AD-LIB functions cannot be used at the same time.

CHAPTER 10

Join the Drum Section (HAND PERCUSSION)

The PV35 does not limit percussion instrument play to the automatic rhythm section. You can play the drums and other percussion instruments manually using the method described below!



Press the **HAND PERCUSSION** button.
The lamp on the button will light up.

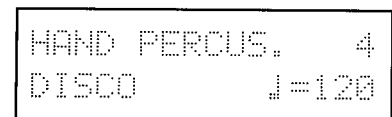

Press a few of the keys on the keyboard.
You will hear percussion sounds instead of the usual melody tone. (These sounds are labeled on the PV35's control panel.)

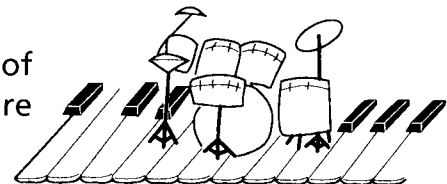

The keyboard becomes a drum set!



Adjust the volume of your "drum set" using the **RHYTHM VOLUME** slider.

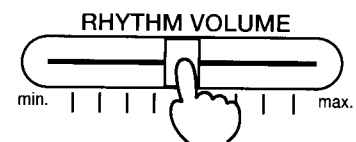

Press the **HAND PERCUSSION** button once when you wish to return the keyboard to normal.



PART TWO

RECORDING YOUR

SONGS

To broaden your range of musical enjoyment. . .

The PV35 is equipped with a floppy disk drive which allows you to record your songs and play them back, just as with a tape recorder. . .except that the sound comes directly from the PV35, so that each and every performance is an exact copy of the original! The disk drive also gives you access to rhythm and accompaniment patterns that you can add to those already inside the PV35. These patterns can vastly extend the range of musical styles available to you.

You might want to begin using floppy disks by listening to some music which we've recorded for you on the disk that came with your PV35. But first, here are a few notes about the handling of floppy disks. . .

CHAPTER 1 How to Handle Floppy Disks

Floppy disks are commonly used by computers, word processors, and other equipment as a means of saving data. The disks used by the PV35 are capable of storing data reliably for an indefinite period of time; however, they must be handled properly. Please observe the following cautions when using floppy disks.

Use only 3.5" 2DD floppy disks!

The PV35 uses 3.5" 2DD floppy disks. Other types of floppy disks (such as 2HD disks) cannot be used with the PV35.

Do not touch the disk or allow it to become soiled!

If you slide the metal shutter on a floppy disk to the left, you will be able to see the actual disk to which data are written by the disk drive. If you touch this disk or allow foreign matter to get inside the shutter, the disk may become damaged. Such damage could make it impossible to save data to the disk or retrieve data from it again.

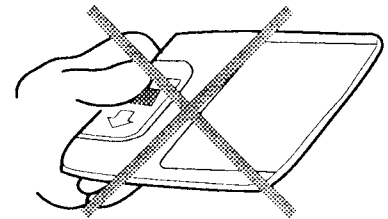

Keep disks away from sources of strong magnetism!

The data saved in floppy disks can be damaged by magnetism. Therefore, do not put disks near magnets, speakers, and other sources of strong magnetism.

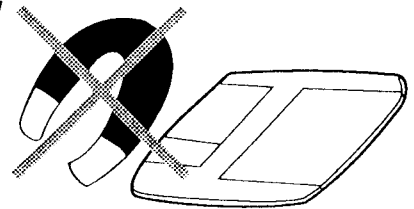

Protect the contents of your disks!

The small hole in the lower left corner of the disk is known as the write protect window. It is used to prevent data from being written to the disk. Data can be saved to the disk when the window is closed. When the window is open, however, the disk drive will not be able to write data to the disk. You should open the window on disks which contain data that you don't want overwritten or erased.

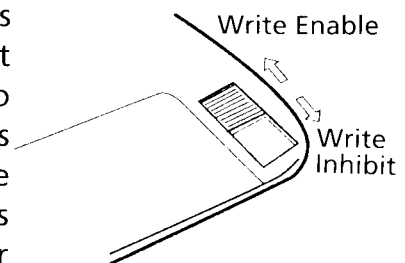

How to Handle Floppy Disks

Insert and remove disks properly!

Insert disks into the PV35's disk slot shutter end first, with the label facing up. You will hear a clicking sound when the PV35 is fully inserted. Simply press the eject button gently to remove the disk from the slot.

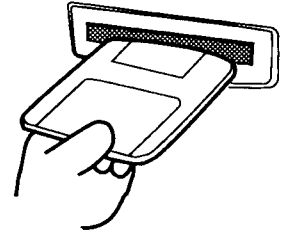

Do not remove disks while the disk indicator lamp is lit!

Do not remove disks while the lamp near the slot is glowing, as doing so could result in the destruction of valuable data.

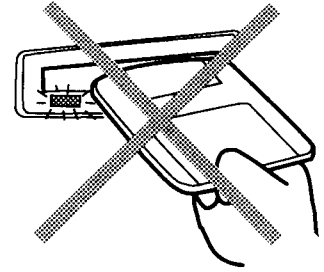

CHAPTER 2

Let's Listen to Some Music

You should have found a floppy disk packaged with your PV35. This disk contains data for songs which will demonstrate for you some of the capabilities of your new keyboard. Here's how you can listen to the songs recorded on these disks. . .

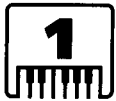

Insert the disk which came with your PV35 into the disk slot.

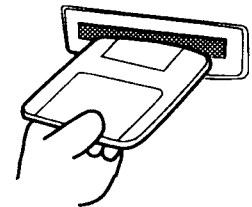

Press the **SONG SELECT** button.

The lamp on the button will light up, indicating that the PV35 has entered SONG SELECT mode. The number and name of a song will appear in the display screen.

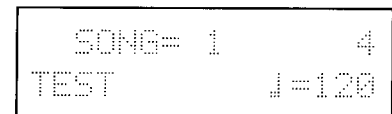

Use the **ARRANGEMENT EXPANDER** dial to select a song to play.



Select "ALL" to listen to all of the songs in order. Press the **REPEAT** button and the songs will continue playing repeatedly until you stop them.

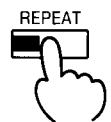

Press the **PLAY** button to begin playback.

The lamp on the button will light up, and the song or songs you have selected will begin to play. The song number will appear in the upper center, and the tempo in the lower right corner of the display screen. The number to the left of the tempo is a counter which shows the number of the measure being played.

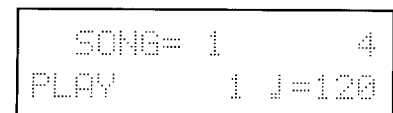

Do not remove the disk from the disk slot while a song is playing.

Let's Listen to Some Music

5

To stop the song temporarily during playback, press the **PLAY/PAUSE** button and the display will change PLAY to PAUSE.



Play stops temporarily.

Pressing this button a second time will cause play to continue.



Play continues.

6

To fast forward a song, press the **FF** button.

The following display will appear:

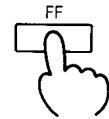

```
SONG= 1      4
FF      139 J=120
```



If you press the fast forward button while the song is paused, the song will be fast forwarded at high speed as long as you hold the button down. The counter will stop changing when the song reaches its end.

You can also press the fast forward button while the song is playing. In this case, the song will play at a speeded-up tempo.

7

Press the **REW** button to "rewind" the song.

The following display will appear:

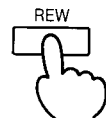

```
SONG= 1      4
REW      45 J=120
```



*You can press the **REW** button either while the song is playing or while the song is paused. In either case, the song will rewind at high speed as long as you hold the button down. No sound will be played while the song is rewinding.*

Recording Your Songs

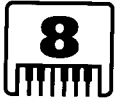

Press the **STOP** button to stop playback.

The counter will be replaced by **SONG NAME** display, and the lamp on the **PLAY** button will go out.

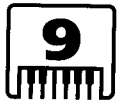
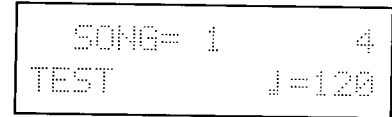
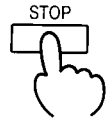

Press the **SONG SELECT** button to leave **SONG SELECT** mode.

The light on the **SONG SELECT** button will go out.



CHAPTER 3

Adding New Rhythm Patterns

The floppy disk that was included with your PV35 keyboard also contains a set of eight rhythm patterns which can be loaded into the PV35 and used just like those you selected earlier using the **RHYTHM** buttons. Optional rhythm data disks are also available separately, giving you a wide selection of rhythms to enjoy on your PV35. The procedure for loading these rhythm patterns is described below.

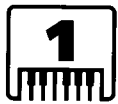

If the PV35 is turned on with the disk in the slot, the data is read in automatically at that time. Otherwise, insert the disk that came with your PV35 into the disk slot.

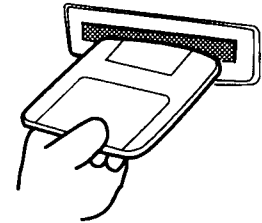

Press the **DISK** button.

The lamp on the button will light up, indicating that the PV35 has entered DISK mode, and the following display will appear.

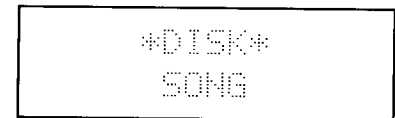
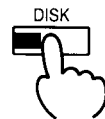

When loading data from optional rhythm data disks, the RHYTHM LOAD display will appear automatically. In this case, skip the following step and proceed to STEP 4.



Use the **TEMPO** (◀ and ▶) buttons or the **ARRANGEMENT EXPANDER** dial to change to the "RHYTHM LOAD" display.

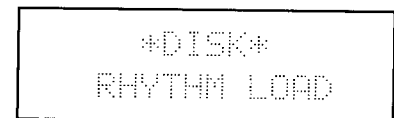
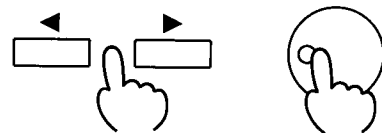

Press the **EXECUTE** button.

The name of a rhythm set will appear in the display.

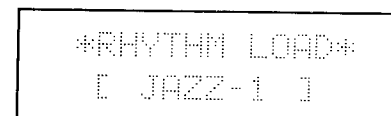
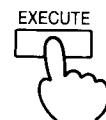

Recording Your Songs

5

Select a rhythm set using either the **TEMPO** (◀ and ▶) buttons or the **ARRANGEMENT EXPANDER** dial.

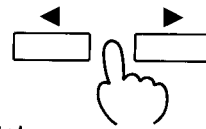

The rhythm set on the disk that comes with your PV35 consists of eight different rhythms.

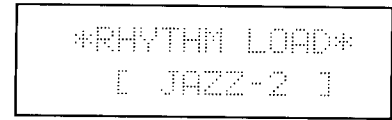

6

Press the **EXECUTE** button. The display will change to EXECUTING.



The rhythm set you have selected will be loaded into the PV35.



Do not remove the disk from the disk slot while the disk indicator lamp is lit.

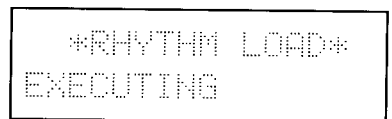

The PV35 will leave DISK mode — and the lamp on the DISK button will go out automatically — when the rhythm data has been loaded.

7

Select a disk rhythm.

The buttons labelled **DISK1**, **DISK2**, **DISK3**, and **DISK4** are used to select disk rhythms. These buttons are used in nearly the same manner as the **RHYTHM**



buttons you have been using. To select one of the disk rhythms numbered 1 through 4, simply press the corresponding button. Thus, to select disk rhythm 1, you would press the **DISK1** button.

To select one of the disk rhythms numbered 5 through 8, however, you must use these buttons in combination with the **VARIATION** button. For example, to select disk rhythm 5, press the **VARIATION** button, followed by the **DISK1** button.

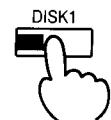
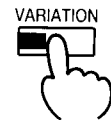

8

Start the rhythm section, using one of the four methods described in Part 1, Chapter 4. (Please refer to page 1 – 9.) These rhythms may be used in exactly the same ways as those which you have been selecting using the **RHYTHM** buttons. There are even matching **AUTO ACCOMPANIMENT** patterns for each, which you can make use of by selecting an **AUTO ACCOMPANIMENT** mode!

CHAPTER 4 Recording Your Songs

You can use the PV35's disk library functions to record songs on floppy disks, and then replay them. A single disk can hold a maximum of 100 songs.



The number of songs which a disk can hold is limited by the volume of data required by the songs recorded on it. Therefore, you may not always be able to fit a full 100 songs on a disk.

A song may consist of as many as sixteen parts, each of which is recorded on a separate track. Each track can be recorded and played back individually. Let's begin with a simple one-track recording. . .



Insert either the disk which came with your PV35 or a formatted disk into the disk slot.

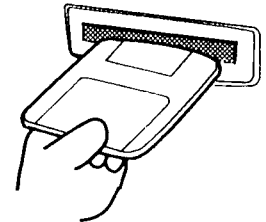

*New floppy disks must be formatted using the **FORMAT** function before data can be saved to them. (Please refer to page 4 - 2 for instructions on the use of the **FORMAT** function.)*



Press the **SONG SELECT** button.

The lamp on the button will light up, indicating that the PV35 has entered **SONG SELECT** mode.



Use the **ARRANGEMENT EXPANDER** dial to select a song number for the song you are going to record.

Songs that have already been recorded have a song name next to them.

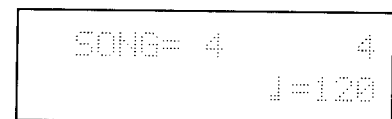

Select the tone, rhythm pattern, tempo and **AUTO ACCOMPANIMENT** mode which you will use when playing the song you wish to record.



You can also change the tone, rhythm, or tempo while you are replaying the song.

Recording Your Songs

5

While holding down the **RECORD** button, use either the **TEMPO** (◀ and ▶) buttons or the **ARRANGEMENT EXPANDER** dial to select the track you will record.

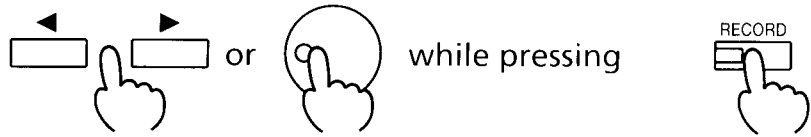

There is also another way to select a track number. While holding down the **RECORD** button, press the **1**, **2**, or **3-16** button. **1**, of course, gives you Track 1 and **2**, Track 2. Repeated pressing of the **3-16** button steps through from Track 3 to Track 16, one track at a time. After Track 16, it starts over at Track 3 again.

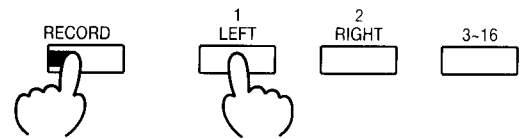

The track number you have selected is shown in the lower line of the display screen, followed by the amount of memory space available on the disk for recording (maximum 610KB.)

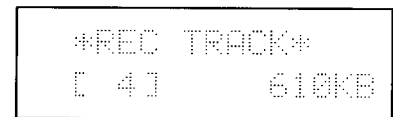

Four little notes (**||||**) in the display indicate that something has already been recorded on that track.

6

Release the **RECORD** button. The lamp on the **SYNC. START** button will light up and the metronome will start clicking. The PV35 is now in pause mode, ready for recording.

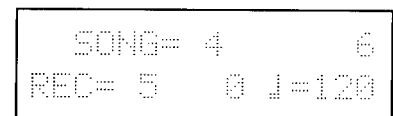

*If at any point you decide that you do not want to record a song after all, press the **STOP** button.*

Recording Your Song

7

Start playing.

The rhythm section will start and the PV35 will begin recording the instant you press a key on the keyboard. When recording begins, the counter will display the number of measures which have elapsed.

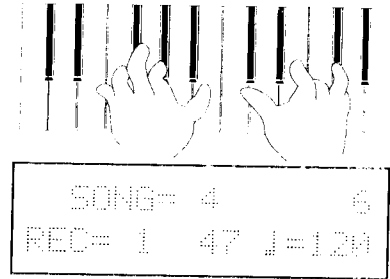

You may also want to try the following methods of starting the recording:

- Press the **PLAY/PAUSE** button to begin the recording without any rhythm. (Note that no accompaniment will be recorded under this method.)
- Press the **INTRO/ENDING** button to begin the recording with an intro pattern.
- Press the **START/STOP** button to start the recording with the rhythm section only.
- If **SYNC. START** is off, recording will start immediately from the pause state if you press the **INTRO/ENDING** or **START/STOP** buttons.

PLAY/PAUSE



INTRO/ENDING

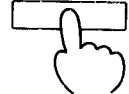

START/STOP

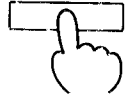

The tone, rhythm pattern and tempo settings will be recorded onto the disk when recording starts.



Do not remove the disk from the disk slot while recording is in progress.

8

Press the **STOP** button to stop recording when you are done playing.

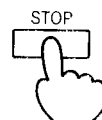

When you finish recording, the PV35 automatically assigns a name to the song you have just recorded, for example:

#_004

Refer to page 4 – 8 to find out how to change this to a more descriptive name.

Recording Your Songs



Press the **SONG SELECT** button.

The lamp on the button will go out, indicating that the PV35 has left the SONG SELECT mode.



Now that you have recorded a song, you will probably want to hear how it sounds. Use the following method to play it back.

(1) Press the **SONG SELECT** button.

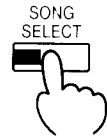

(2) Use the **ARRANGEMENT EXPANDER** dial to select the song you want to play.



The lamps on the buttons corresponding to tracks for which data has been recorded will light up.

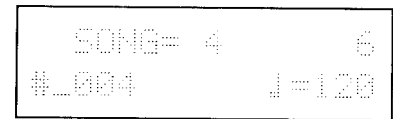

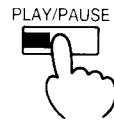

(3) Press the **PLAY/PAUSE** button to begin playback.

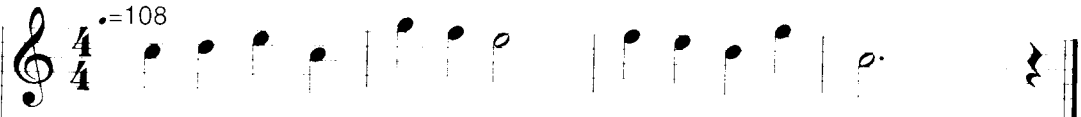

CHAPTER 5 Recording the Right and Left Hands Separately

Less experienced players might find it difficult to play with both hands at once. Such players might find it helpful to record each hand separately — using a variation of the procedure described in the preceding chapter — and then play back the results together. Let's try recording the sample of music shown below, one hand at a time.

Right hand 

Left hand 

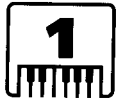

As in Chapter 4, press the **SONG SELECT** button, and then use the **ARRANGEMENT EXPANDER** dial to select a song number for the song you are going to record.

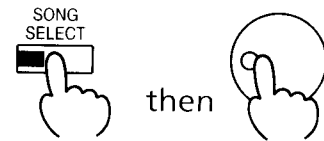

Select the tone, rhythm pattern and tempo you want to use.



While holding down the **RECORD** button, use either the **TEMPO** (◀ and ▶) buttons or the **ARRANGEMENT EXPANDER** dial to select the track you will record.



We will begin our recording with the right hand part, so select Track 2 this time.

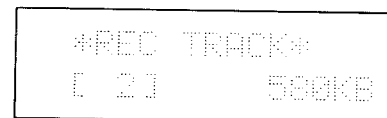

Release the **RECORD** button. The lamp on the **RECORD** button will light and the metronome will start clicking. The PV35 is now in pause mode, ready for recording.

Recording Your Songs

4

Start recording using one of the methods described in the preceding chapter. (Please refer to page 2 - 11)

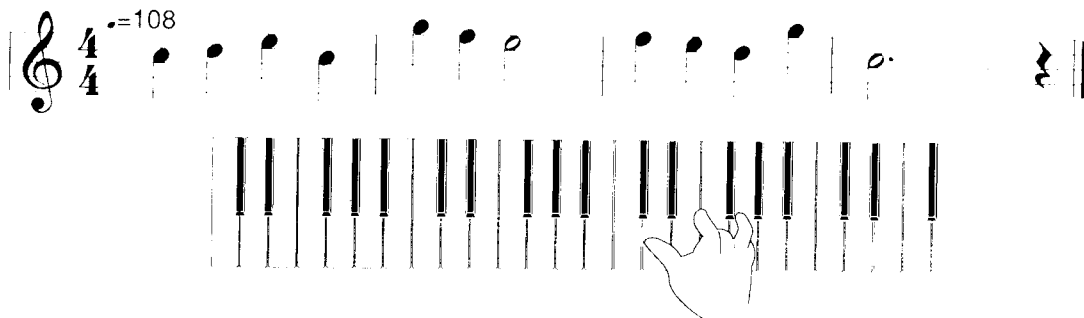

Try playing the music above using only your right hand.

5

Press the **STOP** button when you are done recording.

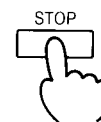

6

Now hold down the **RECORD** button, and use either the **TEMPO** (◀ and ▶) buttons or the **ARRANGEMENT EXPANDER** dial to select another track to record.



This time you should use Track 1 to record the left hand part.

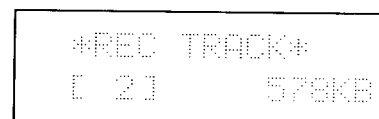

7

Make sure that the lamp on the **2/RIGHT** button is lit. (If it is not, press it now.) This corresponds to Track 2, where you have just recorded the right-hand part, and allows you to listen to that part as you record the left hand.



Recording the Right and Left Hands Separately

8

Press the **PLAY/PAUSE** button to start recording the left hand part.

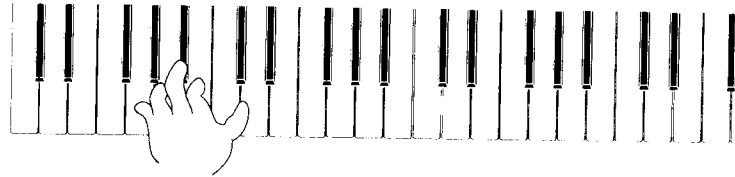
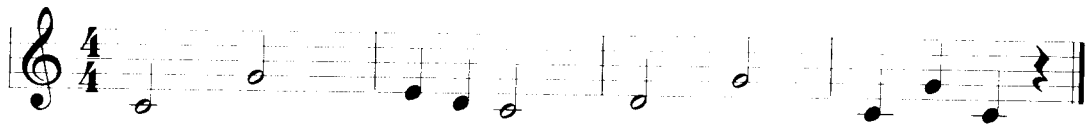

Try playing the music above in time with the right hand part:



*The rhythm that was present when the right hand was recorded will drop out if you start the recording from **SYNC.START**, with the **START/STOP** or the **INTRO/ENDING** buttons. You can now record the left hand with a different rhythm if you want.*

9

As before, press the **STOP** button when you are done recording.

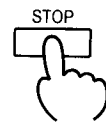

This completes your first two-track recording!



The procedure used to play back this recording is similar to that described at the end of Chapter 4. Begin selecting the song, if necessary, in the same manner. Then:

- (1) Make sure the lamps on both the **1/LEFT** and **2/RIGHT** buttons are lit (if not, press them now.)



- (2) Press the **PLAY** button.

The PV35 will play back the right hand part and the left hand part simultaneously!



If you have made any mistakes recording either track, just select that track again and repeat the process to re-record it. The previous contents of that track will be erased automatically.

CHAPTER 6

Recording With More than One Tone

You have just used Tracks 1 and 2 to complete your first multi-track recording. You can use all sixteen of the PV35's recording tracks in pretty much the same way. In fact, each track can be used to record notes played with a different tone, and then combined for a true ensemble performance.



Here is a breakdown of how tracks are used:

- **Track 1** This is the main track. It is generally used to record the left hand part, as you did in Chapter 5.
- **Track 2** This is the secondary track. It is generally used to record the right hand part.
- **Tracks 3 through 16** These are tertiary tracks. They may be used to record additional parts such as solos and obligatos in tones other than the melody tone.
- **Track 10** This is reserved for percussion sounds.

Use the following procedure to record each track:



Press the **SONG SELECT** button, and then use the **ARRANGEMENT EXPANDER** dial to select a song number for the song you are going to record.



Select the rhythm you will use, if any.



Press one of the **TONE** buttons to select the tone you will use for the track.



Set the volume for each of the parts you are recording.



While holding down the **RECORD** button, use either the **TEMPO** (◀ and ▶) buttons or the **ARRANGEMENT EXPANDER** dial to select the track you will record.

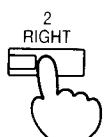

or



while pressing



If you select Track 10, **HAND PERCUSSION** is automatically set.

Recording With More than One Tone



Start recording using one of the methods described in the Chapter 4 (please refer to page 2 – 11).



Press the **STOP** button when you are done recording.

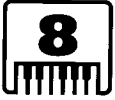

Now, select a different tone and then select a new track to record it on.



*Press the **TRACK** buttons corresponding to tracks which have already been recorded so you can listen to them while recording the next track.*



Press the **PLAY/PAUSE** button to start recording the new track you selected in STEPS 8. A new rhythm accompaniment can be recorded if you start the recording with the **START/STOP** or **INTRO/ENDING** buttons.



Stop recording the new track by pressing the **STOP** button. Pressing the **START/STOP** or the **INTRO/ENDING** buttons will stop the rhythm accompaniment, but not the recording itself.

Repeat STEPS 8 through 10 for each new track you want to add to your composition, up to a maximum of 16 tracks.



Keep in mind the following points when making multi-track recordings:

- *Re-recording the track which have already been recorded will erase the previous recording.*
- *Use Track 1 to record when using the **AUTO ACCOMPANIMENT** function. The **AUTO ACCOMPANIMENT** will not play back properly if you use any other track.*
- *Use Track 10 to record **HAND PERCUSSION**.*
- *If you make any mistakes while recording a track, just select that track again and repeat the process to re-record it. (Be careful not to select and erase a track that you want to keep, though!)*

CHAPTER 7 Playing Back Individual Tracks

For Multiplexed recordings and software, many tracks may be used to compose the piece. The PV35 allows you to select individual tracks for replay.



You cannot select tracks that have not been recorded.



Select the piece to be played. The lamps for the track buttons of recorded tracks will light.



For tracks 3 to 16, the button will light if any of them is recorded.



Select the tracks that are not to be played.

- Tracks 1 or 2
Press the corresponding **TRACK** button and the light will go out.
 - Tracks 3 to 16
1. While holding down the **3~16 TRACK** button, use the **TEMPO** (◀ and ▶) buttons to move the cursor.

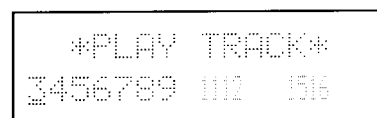
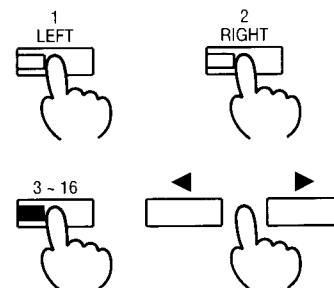

2. While holding down the **3~16 TRACK** button, use the **ARRANGEMENT EXPANDER** dial to display the "*" mark.

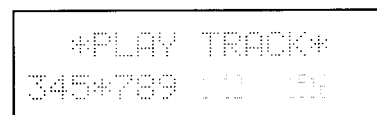
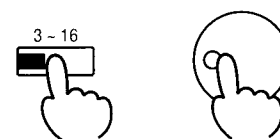

3. Release the **3~16 TRACK** button to store the settings.



Tracks that have not been recorded will not be displayed.



Start play.



Tracks can be turned on and off during play.

PART THREE

GETTING THE MOST

OUT OF YOUR PV35

A few special operations. . .

In Part One you learned how to play music using the PV35's keyboard, rhythm, and AUTO ACCOMPANIMENT functions. Part Two showed you how to record and play back songs on floppy disks. In this part we would like to show how you can put the PV35's flexibility to best use by transposing the pitch of the songs you play; by assigning different functions to the left pedal; and by saving the various settings you make in the PV35's REGISTRATION MEMORY.

CHAPTER 1 Changing Keys (TRANPOSE)

You know a song in the key of C. But your friend, who plays a saxophone, only knows it in A[♭]. You want to play a duet, but what can you do? Relax! The PV35's TRANPOSE function makes changing keys a snap.

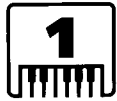

Press the **TRANPOSE** button.

The **TRANPOSE** function display will appear, showing the PV35's current key setting.

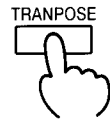

Use the **TEMPO** (◀ and ▶) buttons or the **ARRANGEMENT EXPANDER** dial to change the key setting.

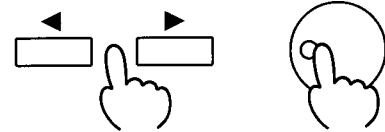

The key can be changed in half-tone steps over a range of one octave from F[♯] to F, the basic key being C.

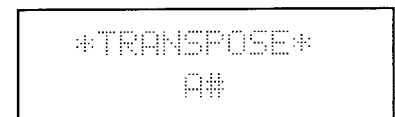

Press either the **TRANPOSE** button, or any one of the tone and rhythm buttons, to leave the **TRANPOSE** mode once you have completed your setting.



You can confirm by the sound when you press the keyboard after selecting the key.

*If you do not change the key setting within a few seconds after pressing the **TRANPOSE** button, the PV35 will leave the **TRANPOSE** mode automatically.*

The PV35 will return to the key of C (which is its default setting) whenever the power is turned off and then on again.

CHAPTER 2 Fine Tuning (TUNE, TUNING CURVE)

Tuning a regular piano is a complicated and expensive job. But retuning your PV35 over the entire keyboard can be done in a few seconds by pressing a button or two! You can use this feature to play along in perfect tune with fixed-pitch instruments.



Press the **MIDI/SYSTEM** button to enter MIDI/SYSTEM mode. You'll see a display like the following:

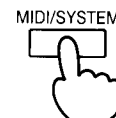

If you don't do anything in MIDI/SYSTEM mode for several seconds, the PV35 will automatically take you out of this mode and back to the main mode.

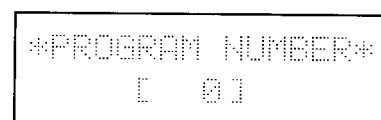

Use the **TEMPO** (◀ or ▶) buttons to move through the options, and stop when you reach the TUNE display, as shown.

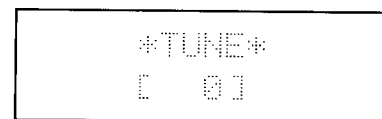
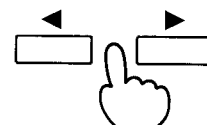

Sound a note (or notes) on the keyboard that you want to tune by, and adjust the pitch with the **ARRANGEMENT EXPANDER** dial. The pitch of the PV35 can be adjusted by +/- 50 cents (100 cents is a half-step), which corresponds to +/- 32 units on this screen.

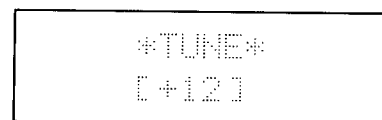

When you've got it tuned the way you want it, press the **MIDI/SYSTEM** button, or any one of the tone and rhythm buttons, to leave this mode.

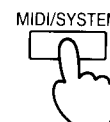

When the PV35 is first turned on, the tuning is set to standard (the A3 key is a 440 Hz), and the TUNE display window shows a 0.

Getting the Most Out of Your PV35

You also have your choice of two different tuning systems: S-curve averaged tuning as used for pianos, or a flat-averaged scheme.

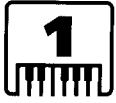

To select between these two choices, first get back into MIDI/SYSTEM mode as we did before, by pressing the **MIDI/SYSTEM** button.

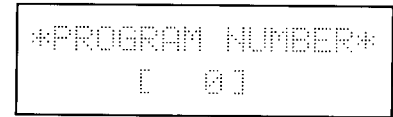
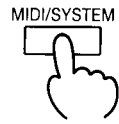

This time, select the TUNING CURVE display with the **TEMPO** (◀ or ▶) buttons.

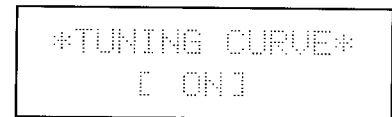
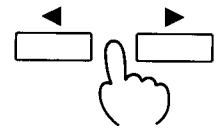

Turn the S-curve tuning system ON or OFF by rotating the **ARRANGEMENT EXPANDER** dial. If TUNING CURVE is OFF, the PV35 is using the flat-averaged tuning scheme.

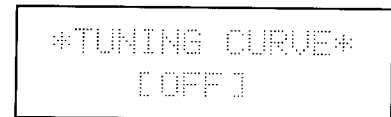

When you're done, exit MIDI/SYSTEM mode as before: by pressing the **MIDI/SYSTEM** button, or any one of the tone or rhythm buttons.

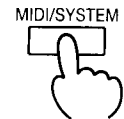

CHAPTER 3 Putting Your Foot Down (PEDAL ASSIGN)

The PV35's left pedal normally functions as a conventional soft pedal. However, it can be assigned a number of other functions which make the PV35 even easier to play. And the right pedal can be used as a damper pedal for the whole keyboard, or just a part of it! Here's how. . .

To assign the LEFT PEDAL, do the following:

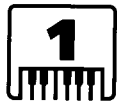

Press the **PEDAL ASSIGN** button.

The PEDAL ASSIGN display will appear, showing the current pedal setting.



The left pedal assignment is automatically set to "SOFT" whenever the PV35's power switch is turned on.

LEFT PEDAL
SOFT



Use the **TEMPO** (◀ and ▶) buttons to select LEFT PEDAL.

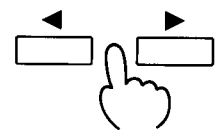

Use the **ARRANGEMENT EXPANDER** dial to select from the following functions:



- **SOFT**

The pedal functions as a soft pedal. The PV35's sound becomes softer and its volume quieter when the pedal is depressed.

LEFT PEDAL
SOFT

- **START/STOP**

The pedal functions in the same manner as the **START/STOP** button. It can be used to start or stop the rhythm.

LEFT PEDAL
START/STOP

- **INTRO/ENDING**

The pedal functions in the same manner as the **INTRO/ENDING** button. It can be used to start the rhythm with an intro pattern, or to stop it after playing an ending pattern.

LEFT PEDAL
INTRO/ENDING

- FILL IN 1, 2, or 3

The pedal functions in the same manner as the corresponding **FILL IN** button. A one measure fill-in pattern is played when the pedal is pressed.

LEFT PEDAL
FILL IN1

- CHORD HOLD

The pedal controls chords played by the **AUTO ACCOMPANIMENT** section. If you depress this pedal while using the **AUTO ACCOMPANIMENT** function, the PV35 will continue playing the current chord as long as you hold the pedal down. The **AUTO ACCOMPANIMENT** chord will not change during this time, even if you finger other chords. This pedal assignment can therefore be used to good advantage in combination with the **AUTO 2** mode.

LEFT PEDAL
CHORD HOLD

- ARRANGEMENT EXPANDER

This pedal steps through the different levels of dynamics, just like spinning the **ARRANGEMENT EXPANDER** dial. The levels go from 1 to 8, then back down to 1, back up to 8, and so on.

LEFT PEDAL
A. EXPANDER



Now, if things are set up to your liking, you could leave **PEDAL ASSIGN** mode by pressing the **PEDAL ASSIGN** button, or any one of the tone or rhythm buttons. But let's take a quick look at how to set the **DAMPER PEDAL**, too, before we leave this mode.

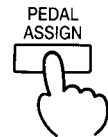

*If you do not change the pedal assignment setting within a few seconds, the PV35 will leave the **PEDAL ASSIGN** mode automatically.*

Putting Your Foot Down

To assign the DAMPER PEDAL, do the following:



Press the **PEDAL ASSIGN** button.



Select **DAMPER PEDAL** by pressing **TEMPO** (◀ and ▶) buttons.

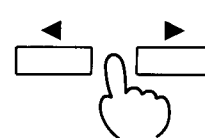

As before, use the **ARRANGEMENT EXPANDER** dial to select one of the following functions:



- **UPPER**

The **DAMPER PEDAL** only works on the upper keyboard. (Remember, you can change the dividing point between upper and lower keyboards in **SPLIT MODE**.)

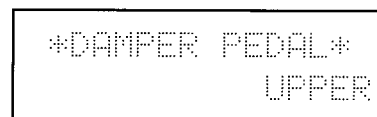

- **LOWER**

The **DAMPER PEDAL** only works on the lower keyboard.

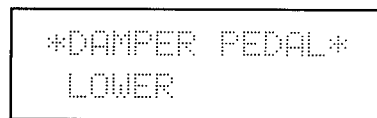

- **UPPER & LOWER**

And now we have the **DAMPER PEDAL** working over the entire keyboard, upper and lower.

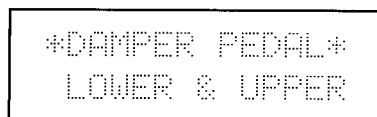

Leave **PEDAL ASSIGN** mode by pressing the **PEDAL ASSIGN** button, or any one of the tone or rhythm buttons.



*If you do not change a pedal assignment setting within several seconds of entering **PEDAL ASSIGN** mode, the PV35 will leave that mode automatically.*

CHAPTER 4 Adjusting the Acoustics (REVERB MODE)

There's nothing like a little reverb to add spaciousness and "glow" to the tones you play on the PV35. There are even some "spacy" delays you can use to add a special effect to your playing. Let's see what they sound like...



Press the **REVERB** button to enter REVERB mode. The display will change to the REVERB screen.

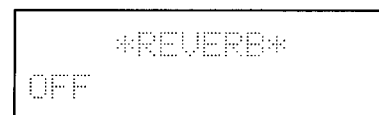

Select the kind of reverb or delay you want with the **TEMPO** (◀ and ▶) buttons or the **ARRANGEMENT EXPANDER** dial. (If you don't select anything for several seconds, the PV35 will automatically leave REVERB mode.) Play a few notes in each of the settings to see what it does for your sound!

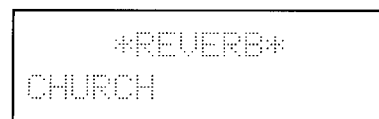
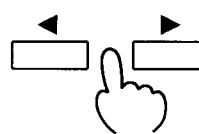

- ROOM
- STUDIO
- LIVE HOUSE
- CONCERT HALL
- CHURCH

These settings add gradually more and more reverb to simulate bigger and bigger rooms.

- COSMIC DELAY
- SPACE DELAY

These settings make the tone sound like it's moving from side to side.

- OFF

Turns all REVERB off. This is the setting the PV35 is in when you first turn it on.



Get out of REVERB mode by pressing the **REVERB** button, or any one of the tone and rhythm buttons. The reverb you have set is now applied to the tones you play on the PV35.



CHAPTER 5

Saving Your Settings (REGISTRATION MEMORY)

It is sometimes difficult to change tones, rhythms, or other settings in the middle of a song — especially if you have to make more than one change in a moment's time. The PV35's REGISTRATION MEMORY feature helps you around this difficulty by saving your settings in its memory. Each group of settings is known as a *registration*. The PV35 is capable of holding up to seven such groups.

Use the procedure described below to save your settings as registrations.



Set the PV35's controls exactly as you would like to save them.

Whenever you save settings to a registration memory, the PV35 will remember the status of the following controls:

- Tone section
TONE, **SPLIT**, and **CHORUS** buttons; **DUAL/SPLIT BALANCE** and **TONE VOLUME** sliders
- Rhythm section
RHYTHM, **VARIATION**, **FILL IN**, and **HAND PERCUSSION** buttons; **RHYTHM VOLUME** slider
- AUTO ACCOMPANIMENT section
AUTO 1, **AUTO 2**, **AUTO MELODY CHORD**, and **ONE FINGER AD-LIB** buttons; **CHORD VOLUME** and **BASS VOLUME** sliders
- Function section
TRANSPOSE, **REVERB MODE**, **SPLIT POINT**, and **LEFT PEDAL** settings
- Other
ARRANGEMENT number; **TEMPO** setting



While holding down the **WRITE** button, press the button with the number of the registration to which you would like to save these settings.

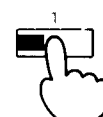

When you release the **WRITE** button, the lamps on the **WRITE** and **REGISTRATION** buttons will go out.

Getting the Most Out of Your PV35



The PV35's **REGISTRATION MEMORY** is easy to use. Just press a **REGISTRATION** button.

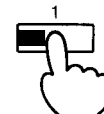

The lamp on that button will light up, and the settings which were saved under that registration will take effect immediately. (You will notice that the lamps on some buttons will light up, while others may go out. The **ARRANGEMENT EXPANDER** dial and the sliders will not move, of course; but the settings which were recorded for these controls will be in effect until you move them.)

You can change the PV35's controls as you like while the registration is in effect; they will act normally, and the contents of the registration will not be changed.

To turn the registration off, simply press a different **REGISTRATION** button to select a new group of settings, or press the same button one more time.

In the latter case, the lamp on the **REGISTRATION** button will go out, and those on the other controls will return to their original state.



The contents of the **REGISTRATION MEMORY** are returned to their default conditions (also known as factory presets) whenever you turn the PV35's power on.

Since the settings you save to the **REGISTRATION MEMORY** will be lost when you turn the PV35's power off, you will want to save your registrations on a floppy disk as described in the next chapter.

CHAPTER 6 Storing Registrations on a Disk (REGIST. SAVE)

The PV35's REGISTRATION MEMORY function would not be very useful if you had to re-register your settings every time you turned the keyboard's power on. Since the PV35 has a disk drive, however, you can save your settings to a floppy disk for future reference. Use the procedure described in this chapter to save the entire contents of the REGISTRATION MEMORY — all seven registrations — on a disk as a single set. Up to ten sets like this can be saved on one floppy disk.

1

Insert a formatted disk into the PV35's disk slot.

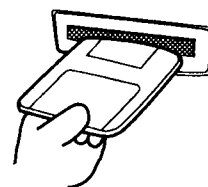

New floppy disks must be formatted using the FORMAT function before data can be saved to them. (Please refer to page 4 – 2 for instructions on the use of the FORMAT function.)

Registrations cannot be saved on optionally available rhythm data disks.

2

Press the **DISK** button.

The lamp on the button will light up, and the following display will appear in the display screen:



DISK
SONG

3

Use the **TEMPO** (◀ and ▶) buttons or the **ARRANGEMENT EXPANDER** dial to select the display shown below.

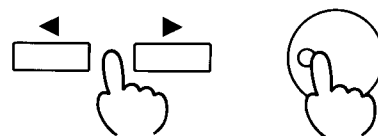

DISK
REGIST. MEMORY

4

Press the **EXECUTE** button.

The following display will appear:



REGIST. MEMORY
LIST

Getting the Most Out of Your PV35

5

Use the **TEMPO** (◀ and ▶) buttons or the **ARRANGEMENT EXPANDER** dial to select the **SAVE** function.

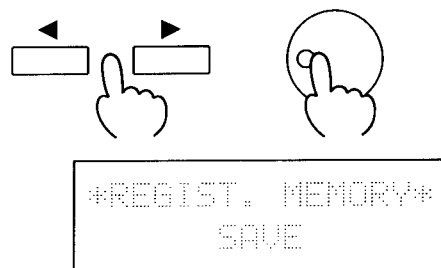

6

Press the **EXECUTE** button again. The following display will appear:

The number in the lower line of the display represents a number under which you may save your **REGISTRATION MEMORY** contents.

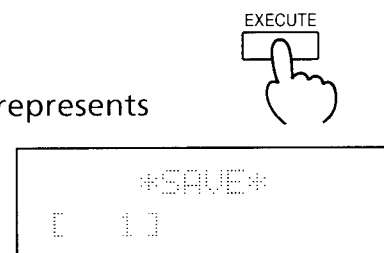

7

Use the **TEMPO** (◀ and ▶) buttons or the **ARRANGEMENT EXPANDER** dial to select the number under which you wish to save your **REGISTRATION MEMORY** data.

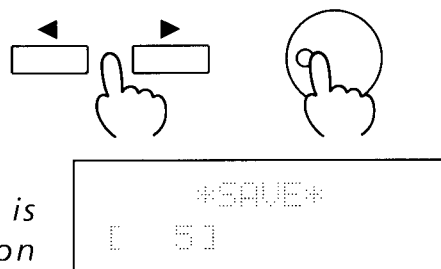

*Remember that this number is different from a registration number. When you save **REGISTRATION MEMORY** data to a disk, the contents of all seven registrations will be saved as a single set.*

You may select a number between 1 and 10, or the PV35 will assign one for you automatically. For example, the fourth registration set would be called \$ _004.

8

Press the **EXECUTE** button one last time.

The PV35 will save your registered settings to the disk as **REGISTRATION MEMORY** data. When it is done saving this data, the light on the **DISK** button will go out, and the PV35 will automatically leave **DISK** mode.



*If (in **STEP 7**) you select a number under which data has been stored previously, the old data will be erased when you save the new data. Be careful when making your selection, so that you do not accidentally erase data which you wanted to keep.*

*To avoid this danger, you might find it helpful to give each set of **REGISTRATION MEMORY** data a name. The procedure for naming **REGISTRATION MEMORY** data sets is outlined on page 4 – 11.*

You will get an error message if you try to write data onto a write-protected disk. If you get this message, remove the disk, slide the write protect tab to the other position, and try again.

CHAPTER 7 Loading Registrations Into the PV35 (REGIST. LOAD)

Use the following procedure when you want to load REGISTRATION MEMORY data which you have stored on a disk back into the PV35.

1

Insert a disk containing REGISTRATION MEMORY data into the PV35's disk slot.



2

Press the **DISK** button.

The lamp on the button will light up, and the following display will appear in the display screen:

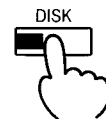

DISK
SONG

3

Use the **TEMPO** (◀ and ▶) buttons or the **ARRANGEMENT EXPANDER** dial to select the display shown below.

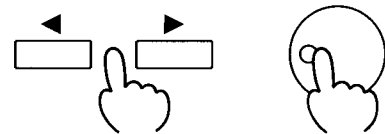

DISK
REGIST. MEMORY

4

Press the **EXECUTE** button.

The following display will appear:



REGIST. MEMORY
LIST

5

Use the **TEMPO** (◀ and ▶) buttons or the **ARRANGEMENT EXPANDER** dial to select the LOAD function.

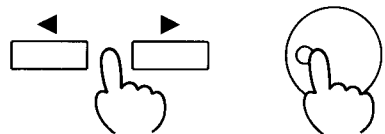

REGIST. MEMORY
LOAD

Getting the Most Out of Your PV35

6

Press the **EXECUTE** button again.

The display will show the number of the lowest-numbered song on the disk.



```
*LOAD*  
[ 1 ] $ 001
```

7

Use the **TEMPO** (◀ and ▶) buttons or the **ARRANGEMENT EXPANDER** dial to select the number of the **REGISTRATION MEMORY** data set which you wish to load.

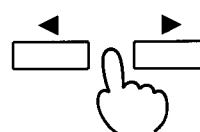

```
*LOAD*  
[ 5 ] MY-RESI.
```

8

Press the **EXECUTE** button one last time.

The PV35 will load the **REGISTRATION MEMORY** data you have selected from the disk. When it is done loading this data, the light on the **DISK** button will go out, and the PV35 will automatically leave **DISK** mode.



*When you load **REGISTRATION MEMORY** from the disk, all **REGISTRATION MEMORY** which the PV35 currently contains will be lost. Be careful that you do not erase registration settings that you wish to keep!*

PART FOUR

USING FLOPPY DISKS

Basic floppy disk operations. . .

You have already seen how the PV35 can make use of floppy disks to expand the range of musical enjoyment it offers you. Not only can you play back the songs and make use of the additional rhythm patterns stored on commercially available disks. . . you can also record the songs you play, and store setting registration data for quick recall.

Now we would like to present, for your reference, explanations of the basic disk operations which we mentioned in Parts Two and Three of this manual. These operations simplify the manipulation of data stored on floppy disks.

When using floppy disks, always remember to follow the handling instructions which were presented in the first chapter of Part Two.

CHAPTER 1 Preparing Disks for Use (FORMAT)

New disks and disks which have been previously used with equipment other than the PV35 must be prepared for use before data can be saved to them. This preparation is called *formatting*. It is accomplished using the procedure described below.



The disk which accompanied your keyboard and other disks which have already been formatted for the PV35 do not need to be formatted again.

The format operation will erase any data which has already been saved to a disk. Be careful not to format disks containing songs or other data that you wish to keep.



Insert a new disk — or a disk containing data which you don't mind erasing — into the PV35's disk slot.

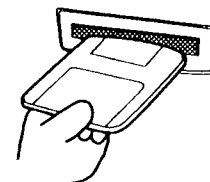

Press the **DISK** button.

The lamp on the button will light up, indicating that the PV35 has entered DISK mode, and the following display will appear:

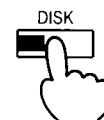

```
*DISK*  
SONG
```



If it's a new or unreadable disk, the PV35 will automatically take you to "FORMAT" and you can skip STEP 3.



Use the **TEMPO** (◀ and ▶) buttons or the **ARRANGEMENT EXPANDER** dial to change the display so that the word "FORMAT" appears.

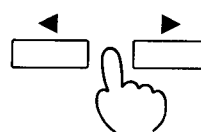

```
*DISK*  
FORMAT
```



Press the **EXECUTE** button.



```
*FORMAT*  
NO
```

Preparing Disks for Use

5

Use the **TEMPO** (◀ and ▶) buttons or the **ARRANGEMENT EXPANDER** dial to select the display shown below.

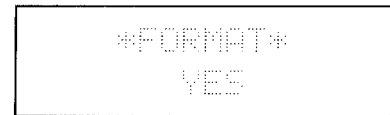
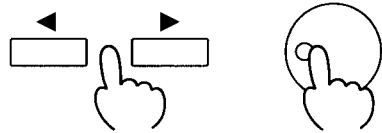

*If you don't want to format the disk, press the **DISK** button to leave the **DISK** mode.*

6

Press the **EXECUTE** button again. The PV35 will begin formatting the disk. The disk indicator lamp will light up, and the following message will appear in the display:

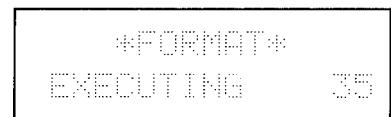

Do not remove the disk while the disk indicator lamp is glowing.

7

When the disk has been completely formatted, the lamp on the button will go out, indicating that the PV35 has automatically left the **DISK** mode.

CHAPTER 2 Listing the Songs on a Disk (LIST)

This function lets you see the numbers and names of songs which have been saved on a disk.

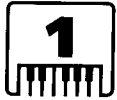

Insert a disk containing song data into the PV35's disk slot.

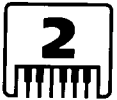

Press the **DISK** button.

The lamp on the button will light up, indicating that the PV35 has entered DISK mode, and the following display will appear.

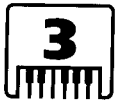
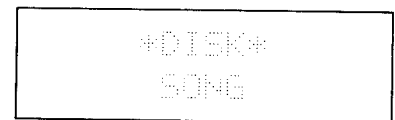

Press the **EXECUTE** button.

The following display will appear:

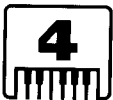

Press the **EXECUTE** button a second time.

The display will show the number and name of the lowest-numbered song on the disk.

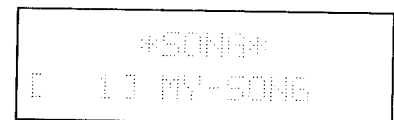

If there's no disk in the slot, the display will say NO DATA! and the PV35 will automatically leave DISK mode.

Listing the Songs on a Disk

5

Use the **TEMPO** (◀ and ▶) buttons or the **ARRANGEMENT EXPANDER** dial to display the numbers and names of the other songs recorded on the disk.

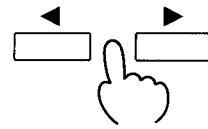

The song will be displayed in song number order.

6

When you are done viewing the list of songs on the disk, press either the **DISK** button or the **EXECUTE** button.

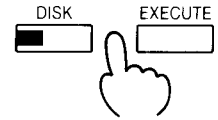

The lamp on the button will go out, and the PV35 will automatically leave the DISK mode.



CHAPTER 3

Listing Registration Sets (REGIST. LIST)

Use this function to list the numbers and names of REGISTRATION MEMORY data sets which have been stored on a disk.

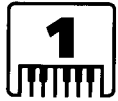

Insert a disk containing REGISTRATION MEMORY data into the PV35's disk slot.

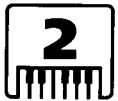

Press the **DISK** button.

The lamp on the button will light up, indicating that the PV35 has entered DISK mode, and the following display will appear.

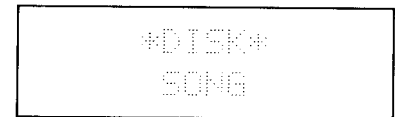

Use the **TEMPO** (◀ and ▶) buttons or the **ARRANGEMENT EXPANDER** dial to select the display shown below.

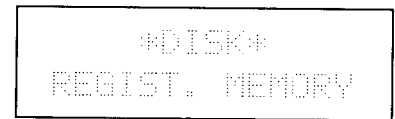
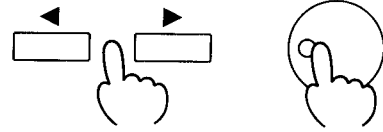

Press the **EXECUTE** button.

The following display will appear:

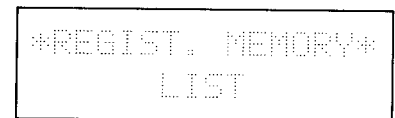

Press the **EXECUTE** button again.

The display will show the number of the lowest-numbered set of REGISTRATION MEMORY data on the disk.

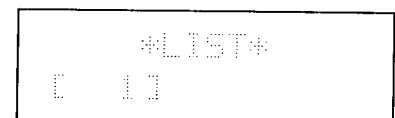

Listing Registration Sets

6

Use the **TEMPO** (◀ and ▶) buttons or the **ARRANGEMENT EXPANDER** dial to display the numbers and names of the other sets of data saved on the disk.

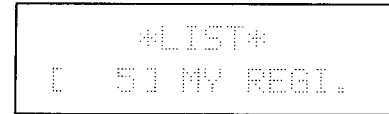
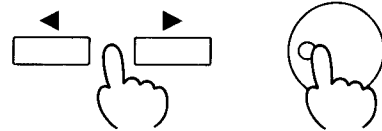

7

When you are done viewing the list of **REGISTRATION MEMORY** data on the disk, press either the **DISK** button or the **EXECUTE** button.

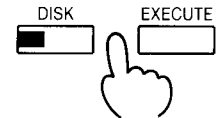

The lamp on the button will go out, indicating and the PV35 will automatically leave **DISK** mode.



CHAPTER 4 Naming Songs (NAME)

The PV35 lets you name each song you save to a floppy disk. You will find that doing so makes the songs you record easier to find.



Insert a disk containing song data into the disk slot.



Press the **DISK** button.

The lamp on the button will light up, indicating that the PV35 has entered DISK mode, and the following display will appear.

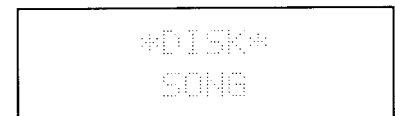
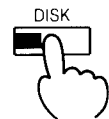

Press the **EXECUTE** button.

The following display will appear:

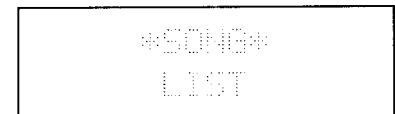

Use the **TEMPO** (◀ and ▶) buttons or the **ARRANGEMENT EXPANDER** dial to select the NAME function.

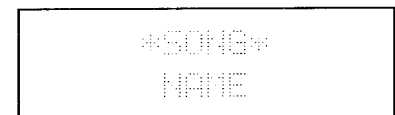
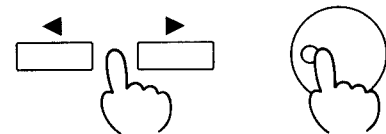

Press the **EXECUTE** button again.

The display will show both the number and name of the lowest-numbered song on the disk:

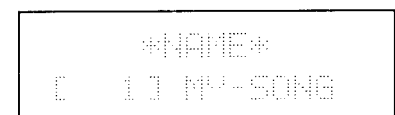

Naming Songs



Use the **TEMPO** (◀ and ▶) buttons or the **ARRANGEMENT EXPANDER** dial to select the song which you wish to name.

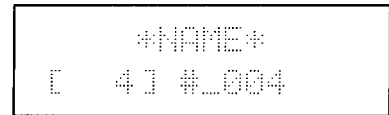
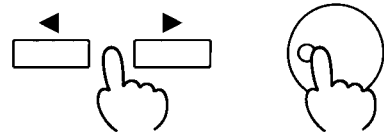

Press the **EXECUTE** button a third time.

A display with a blinking cursor will appear in the display screen.

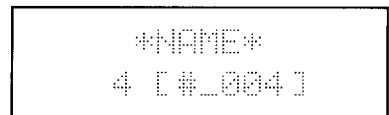

Enter the song's name, up to 8 characters long, using the **TEMPO** (◀ and ▶) buttons to move the cursor and the **ARRANGEMENT EXPANDER** dial to select characters.

1. Move the cursor.

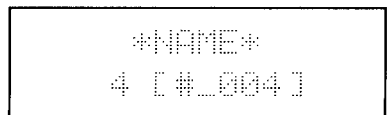
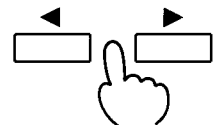

2. Select a letter.

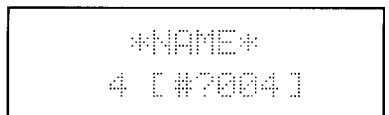

3. Select a cursor.

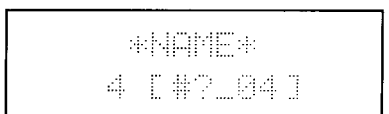
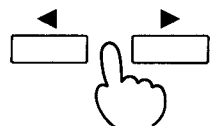

*If you find that you want to stop at this point without naming a song, press the **DISK** button to leave DISK mode.*

Using Floppy Disks

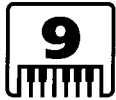

When you have entered the name completely, press the **EXECUTE** button one final time to save the song's name on the disk.

The lamp on the **DISK** button will go out, indicating and the PV35 will automatically leave DISK mode.



You will get an error message if you try to save this information onto a disk with the write-protect tab in the ON position. Take the disk out of the slot, slide the tab over to OFF and try again.



Here is a list of the characters you can use when naming a song:

```
!"#$%&'()*+,-./0123456789:; <=>?  
@ABCDEFGHIJKLMNPOQRSTUVWXYZ [ ] ^ _  
` abcdefghijklmnopqrstuvwxyz ( ) * +
```

CHAPTER 5

Naming Registration Sets (REGIST. NAME)

Use this function to name the REGISTRATION MEMORY data sets which you have saved on a disk.

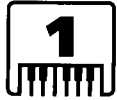

Insert a disk containing REGISTRATION MEMORY data into the PV35's disk slot.



Press the **DISK** button.

The lamp on the button will light up, indicating that the PV35 has entered DISK mode, and the following display will appear.

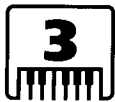
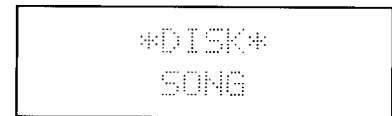

Use the **TEMPO** (◀ and ▶) buttons or the **ARRANGEMENT EXPANDER** dial to select the display shown below.

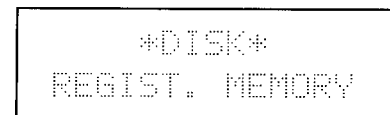
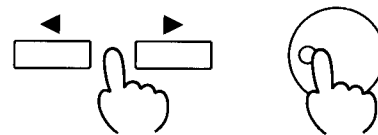

Press the **EXECUTE** button.

The following display will appear:

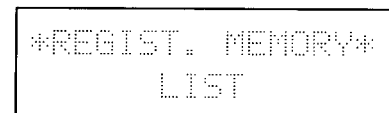

Use the **TEMPO** (◀ and ▶) buttons or the **ARRANGEMENT EXPANDER** dial to select the REGIST. NAME function.

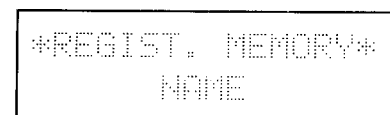
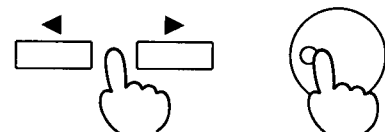

Using Floppy Disks

6

Press the **EXECUTE** button again.

The display will show the number and name of the lowest-numbered set of **REGISTRATION MEMORY** on the disk:

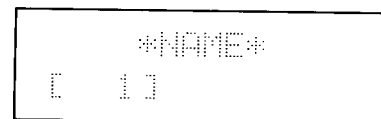

7

Use the **TEMPO** (◀ and ▶) buttons or the **ARRANGEMENT EXPANDER** dial to select the song which you wish to name.

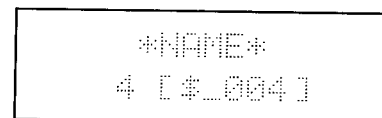
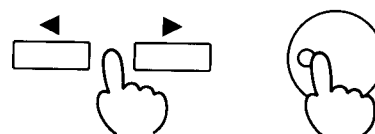

8

Press the **EXECUTE** button a third time.

A blinking cursor will appear in the display screen.

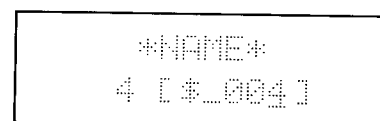

9

Enter a name for the **REGISTRATION MEMORY** data, using the **TEMPO** (◀ and ▶) buttons to move the cursor and the **ARRANGEMENT EXPANDER** dial to select characters.

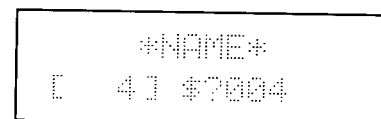
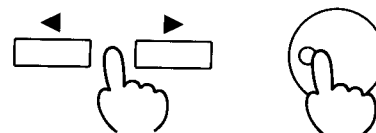

*If you find that you want to stop at this point without naming the data, press the **DISK** button to leave **DISK** mode.*

10

When you have entered the name completely, press the **EXECUTE** button one last time to save it on the disk.



The lamp on the **DISK** button will go out, indicating and the PV35 will automatically leave **DISK** mode.



*For a list of the characters which you can use when naming **REGISTRATION MEMORY** data sets, please refer to page 4 – 10.*

CHAPTER 6 Removing Songs from a Disk (DELETE)

Use this function to remove songs you no longer need from a disk.



Insert a disk containing song data into the disk slot.



Press the **DISK** button.

The lamp on the button will light up, indicating that the PV35 has entered DISK mode, and the following display will appear.

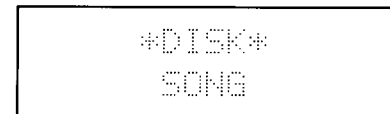
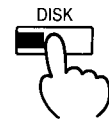

Press the **EXECUTE** button.

The following display will appear:

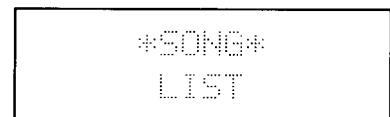

Use the **TEMPO** (◀ and ▶) buttons or the **ARRANGEMENT EXPANDER** dial to select the DELETE function.

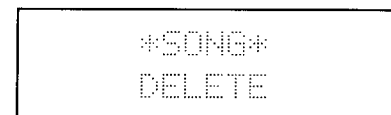
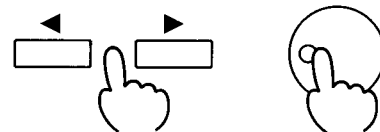

Press the **EXECUTE** button again.

The display will show both the number and name of the lowest-numbered song on the disk.

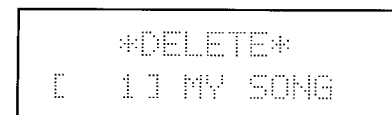

Using Floppy Disks

6

Use the **TEMPO** (◀ and ▶) buttons or the **ARRANGEMENT EXPANDER** dial to select the song which you wish to delete.

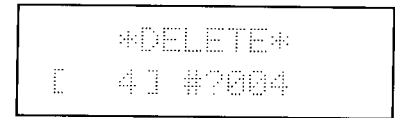
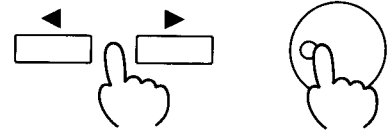

7

Press the **EXECUTE** button a third time.

The PV35 will ask you weather you are sure you want to delete the song you have selected.

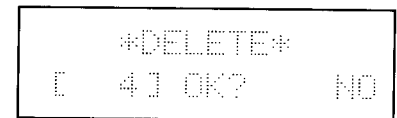

8

Use the **TEMPO** (▶) button or the **ARRANGEMENT EXPANDER** dial to change the display so that it says YES.

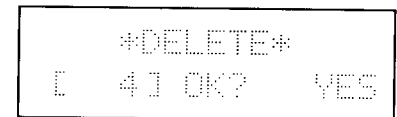
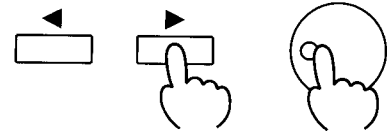

9

Press the **EXECUTE** button one last time to delete the song.

Then the lamp on the **DISK** button will go out, and the PV35 will automatically leave DISK mode..



*If you change your mind about deleting a song, press the **TEMPO** (◀) button or the **ARRANGEMENT EXPANDER** dial to select the **NO** response any time before you press the **EXECUTE** button. The PV35 will leave the **DISK** mode without removing the song from the disk.*

*As before, make sure the write-protect tab on the floppy disk is **OFF** before you try to save any changes to the disk.*

CHAPTER 7 Copying Songs (COPY)

You can use this handy function to copy a song from one floppy disk to another, or to make another copy of a song on the same disk.



Insert a disk containing song data into the disk slot.



Press the **DISK** button.

The lamp on the button will light up, indicating that the PV35 has entered DISK mode, and the following display will appear.

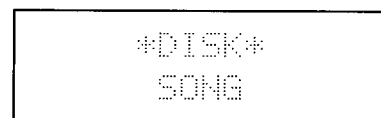
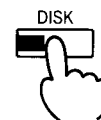

Press the **EXECUTE** button.

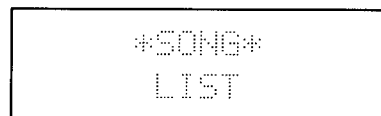

Use the **TEMPO** (◀ and ▶) buttons or the **ARRANGEMENT EXPANDER** dial to select the COPY function.

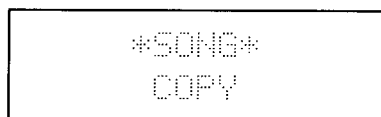
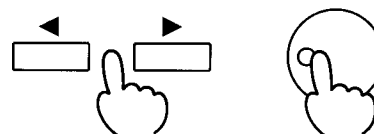

Press the **EXECUTE** button again.

The display will show the number of the lowest-numbered song on the disk.

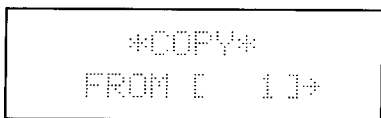

Using Floppy Disks

6

Use the **TEMPO** (◀ and ▶) buttons or the **ARRANGEMENT EXPANDER** dial to select the song you wish to copy.

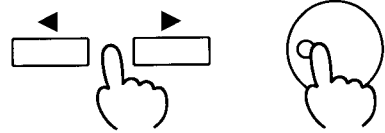

```
*COPY*  
FROM [ 5]→
```

7

Press the **EXECUTE** button.

The following display will appear, asking you whether you want to copy a song from one disk to another.



```
*COPY*  
CHANGE DISK? NO
```

8

Use the **TEMPO** (◀ and ▶) buttons or the **ARRANGEMENT EXPANDER** dial to select your answer.

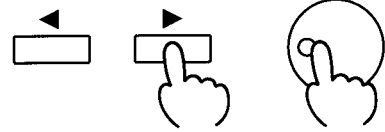

```
*COPY*  
CHANGE DISK? YES
```

Choose YES if you want to copy a song to another disk. Choose NO if you want to make another copy of a song on the same disk.

9

Press the **EXECUTE** button.

A display like the following will appear.



```
*COPY*  
5→TO[ 10] * 2
```

Number of
exchanging disk ↑

10

Use the **TEMPO** (◀ and ▶) buttons or the **ARRANGEMENT EXPANDER** dial to select the song number for the copied version.

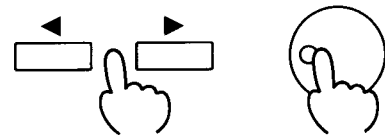

```
*COPY*  
5→TO[ 4] * 2
```

Copying Songs

11

Press the **EXECUTE** button. The display will say **EXECUTING** as the PV35 starts reading the data you want copied from the disk.



Now, one of two things will happen, depending on what you answered in STEP 8, "do you want to copy files from one disk to another?" If you answered "Yes," you will see the following display. (The "D" indicates that you should put in the disk you want the song copied onto.)

```
*COPY*  
CHANGE DISK!  D
```

If you said "No" in STEP 8, then the PV35 goes ahead and copies the song onto the same disk. When it's done the DISK light goes out, indicating that the PV35 has automatically left the DISK mode. (Skip the remaining steps.)

12

Take out the disk you're copying from, and insert the disk onto which you want the song copied.

13

Press the **EXECUTE** button. The PV35 will copy the song onto the second disk, and the display will say **EXECUTING**. After that's finished, you will get the following display telling you to put the original disk back in (indicated by the "S").



```
*COPY*  
CHANGE DISK!  S
```

14

Insert a disk containing song data into the disk slot.

15

Press the **EXECUTE** button.

You can repeat STEPS 12-15 to copy more songs, and when you're done copying, the DISK light will go out, and the PV35 will automatically leave DISK mode.



PART 5

MAKING THE MIDI

CONNECTION

A whole new dimension in music. . .

Users of the PV35 who have become accustomed to this electronic keyboard's many exciting functions will undoubtedly be interested in expanding their musical capabilities by connecting it to other instruments. What they need is MIDI: a revolutionary system which allows digital musical instruments to communicate with each other.

We can hardly tell you all there is to say about MIDI in such a small amount of space. But please permit us to give you a brief introduction to the subject. . .

CHAPTER 1

An Overview of MIDI

MIDI is an acronym for Musical Instrument Digital Interface, which is an international standard for exchanging musical information between electronic instruments such as electronic pianos, synthesizers, and sequencers through a special cable. With MIDI, you can operate one instrument to play sounds on several other instruments, or use a sequencer for automatic play.

MIDI Connections

Electronic instruments with MIDI capability are usually equipped with three types of jacks: MIDI IN, MIDI OUT, and MIDI THRU. (There are some instruments which lack MIDI THRU jacks, however.) Instruments are connected to each other via MIDI cables using these jacks.

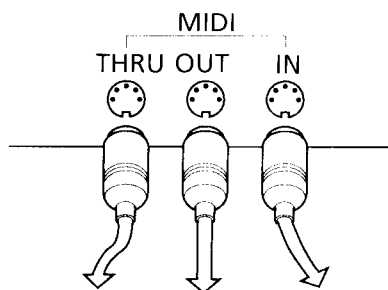

- **MIDI OUT**
Musical information is converted to electric signals and output through this jack. It is connected to the MIDI IN jack of another instrument.
- **MIDI IN**
This jack is for the input of musical information from another instrument. It is connected to the MIDI OUT or MIDI THRU jacks on other instruments.
- **MIDI THRU**
Data input to an instrument through the MIDI IN jack can be output as is through that instrument's MIDI THRU jack. This allows you to connect three or more other instruments to each other.

WHAT MIDI CAN DO

The kind of information that is sent and received varies from one type of instrument to another. With the PV35, you can make use of the following MIDI functions:

- You can specify which MIDI channels the PV35 will send and receive through (up to a maximum of 16.)
- You can send and receive keyboard information (that is, information telling what keys are played).
- You can send and receive tone change information.
- You can send and receive information turning the soft and damper pedals on or off.
- You can send sostenuto on/off information.
- You can switch local control off (turning the keyboard off so that the PV35 will only produce sound when it receives a MIDI signal from another instrument.)
- You can switch the PV35's MULTI TIMBRE mode on or off.
- You can record on up to 16 channels at once using the multi-track recorder (MULTI-REC).

What is a MIDI Channel?

There are sixteen channels which MIDI instruments use to communicate to each other. Instruments must be set to the same channel if they are to communicate with each other, as they must when you use MIDI to play more than one instrument at the same time. If an instrument sending information is not on the same channel as the receiving instrument, no information can be exchanged.

For example, when three instruments are connected and their channels set as you see in the figure below, playing a note on instrument A will cause instrument C to sound at the same time; however, there will be no sound from instrument B.

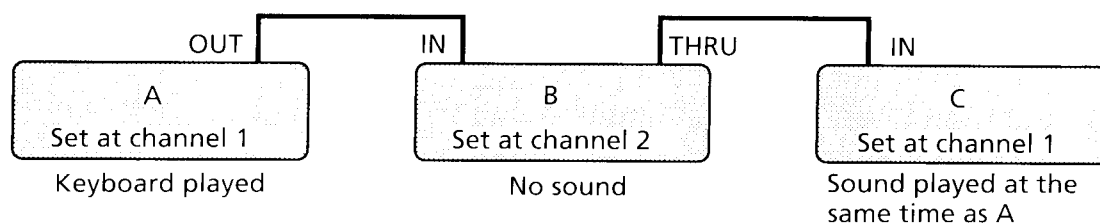

The PV35 can be set to any of the 16 MIDI channels.

Making the MIDI Connection

Examples of Actual Connections

The ways in which instruments can be connected using MIDI are practically limitless, so we'll limit ourselves to three. First, you could connect the PV35 to another MIDI keyboard, such as the KAWAI KC10 Digital Synthesizer, as shown below.

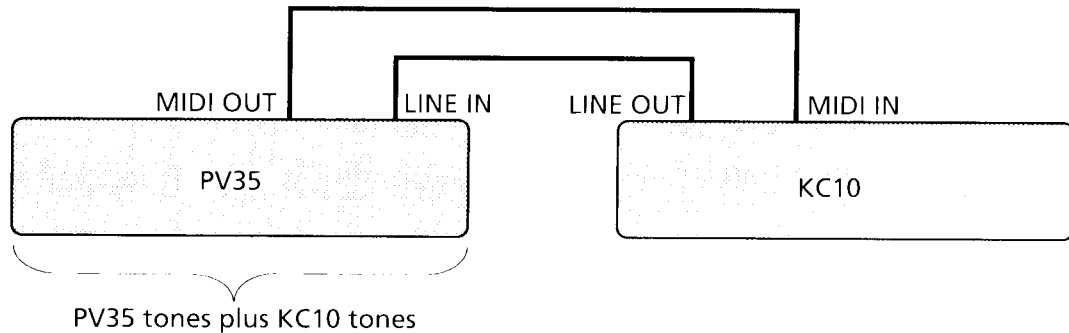

When connected as you see here, note information from the PV35 (indicating which keys are pressed) would be sent as is to the KC10. You could also then connect the KC10's LINE OUT jack to the PV35's LINE IN jack using an audio cable, and the KC10's sounds will be played in perfect sync with the sounds you play on the PV35. Since tones can be selected separately, you could create a wide variety of rich-sounding ensembles by combining the sounds of the two keyboards. A piano sound from the PV35 with a string sound from the synthesizer, for instance. Or you could reverse the MIDI IN and MIDI OUT connections for the two instruments if you wanted to play the PV35 from the synthesizer's keyboard.

Next, you could try using the PV35 to control a tone generator module such as the KAWAI K4r.

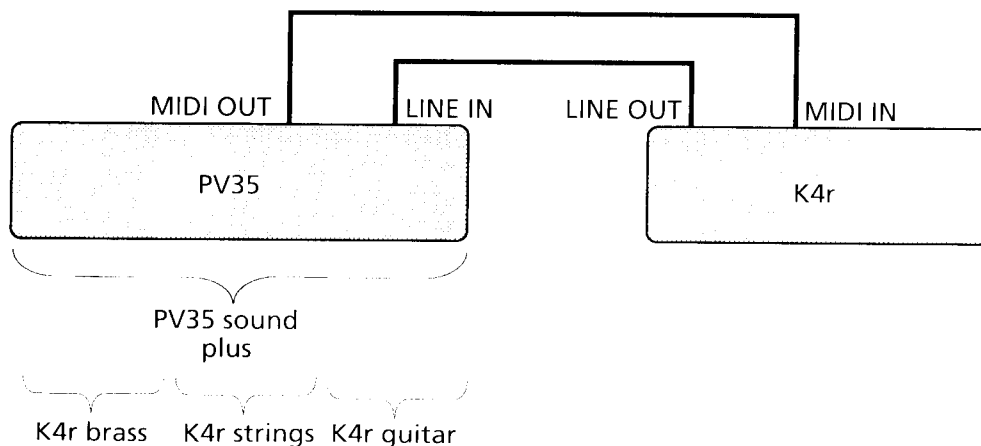

By connecting these instruments in this manner, you could not only combine their sounds as in the previous example, you can also play different tones with different ranges of the keyboard. In the example you see here, the K4r is set in the MULTI mode to play a three-tone multi-timbre split.

An Overview of MIDI

Finally, you can use the PV35 as a sequencer to control one or more MIDI instruments. Let's connect it to three synthesizers this time.

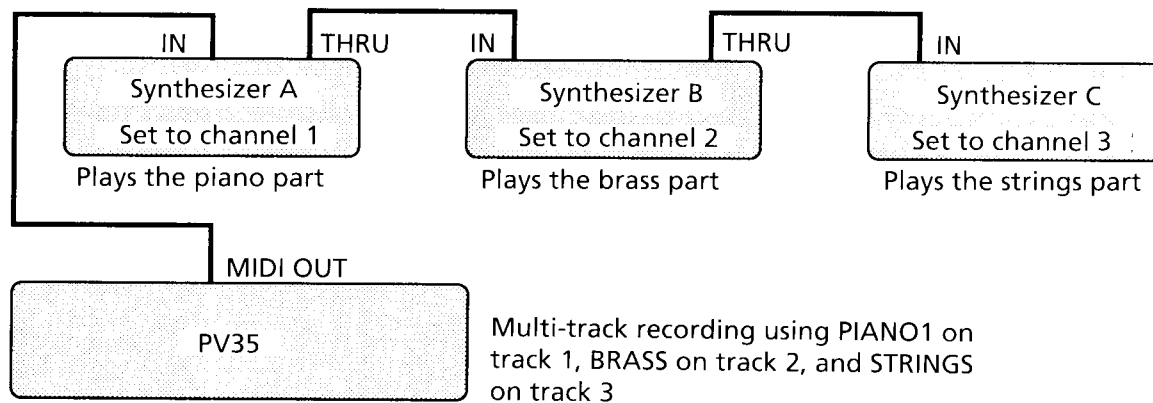

Multi-track recording using PIANO1 on track 1, BRASS on track 2, and STRINGS on track 3

A setup like this would allow you to combine the tones you recorded using the PV35's recording function with those of the synthesizers. This would give your automatic playback a thicker, richer sound. To do this, however, you would have to set the PV35 so that each track corresponded to a MIDI channel as shown below:

Track 1 — Channel 1

Track 2 — Channel 2

Track 3 — Channel 3

Track 16 — Channel 16

CHAPTER 2 Selecting the Basic Channel

Use this method to set the PV35's sending and receiving channels.



The PV35 is automatically set to MIDI channel 1 each time you turn the power on.



Press the **MIDI/SYSTEM** button.

MIDI/SYSTEM



Press the **TEMPO** (◀ and ▶) buttons to select the **BASIC CH.** display.

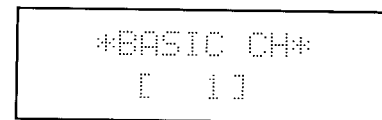
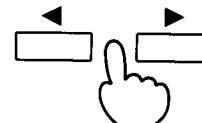

Turn the **ARRANGEMENT EXPANDER** dial to select the desired MIDI channel.

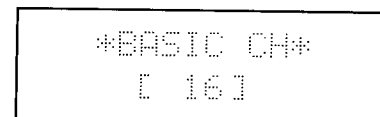

Press the **MIDI/SYSTEM** button, or any one of the tone or rhythm buttons.

The standard display will reappear, and the PV35 will leave MIDI/SYSTEM mode.



*If you do not press a **TEMPO** (◀ and ▶) button or turn the **ARRANGEMENT EXPANDER** dial within several seconds after you press the **MIDI/SYSTEM** button, the PV35 will leave the **MIDI/SYSTEM** mode automatically.*

CHAPTER 3

Sending and Receiving Program Numbers

Program numbers are the numbers which MIDI instruments use to refer to their tones. With the PV35, each program number corresponds to a **TONE** button.

Sending and Receiving Program Numbers with the TONE Buttons

On the PV35, program numbers are allotted to the tones as shown in the charts below. By pressing a **TONE** button, you can send the corresponding program number to switch the tone of a MIDI instrument connected to the PV35. When the PV35 is set to receive, switching the tone on the connected instrument will change the tone of the PV35 to the corresponding program number.

TONE button program numbers on the PV35

- Panel Tones

TONE button	Program No.	TONE button	Program No.
PIANO1	0	STRING ENSEMBLE	48
PIANO2	1	WOOD BASS 1	64
E. PIANO1	3	WOOD BASS 2	65
E. PIANO2	4	ELECTRIC BASS 1	66
JAZZ ORGAN	8	ELECTRIC BASS 2	67
FULL ORGAN	11	SLAP BASS	68
HARPSICHORD	16	FLUTE	72
CLAVI	19	SAX	80
ACOUSTIC GUITAR	22	TUBA	94
JAZZ GUITAR	23	BRASS	95
SYNTH. BASS	28	VIBRAPHONE	97
VOICE ENSEMBLE	34		

Making the MIDI Connection

- AUTO ACCOMPANIMENT Tones (receive only)

TONE	Program No.	TONE	Program No.
PIANO	2	CHORUS TUBA	45
E. PIANO	5	CLICK	46
CHORUS E. PIANO	6	CHORUS CLICK	47
HONKY TONK PIANO	7	STRING ENSEMBLE	49
JAZZ ORGAN	9	CHORUS STRING ENSEMBLE	50
CHORUS JAZZ ORGAN	10	PIZZICATO STRINGS	51
FULL ORGAN	12	VIOLIN	52
CHORUS FULL ORGAN	13	CHORUS VIOLIN	53
ACCORDION	14	SOFT WOOD BASS	54
CHORUS ACCORDION	15	CHORUS SOFT WOOD BASS	55
HARPSICHORD	17	CHORUS PIZZICATO STRINGS	56
CHORUS HARPSICHORD	18	ACOUSTIC GUITAR	57
CLAVI	20	CHORUS ACOUSTIC GUITAR	58
CHORUS CLAVI	21	FOLK GUITAR	59
BRIGHT BRASS	24	CHORUS FOLK GUITAR	60
CHORUS BRIGHT BRASS	25	CUTTING GUITAR	61
DISTORTED GUITAR	26	CHORUS CUTTING GUITAR	62
CHORUS DISTORTED GUITAR	27	BANJO	63
SYNTHE. BASS	29	SLAP BASS	69
CHORUS SYNTHE. BASS	30	HARD WOOD BASS	70
CHORUS SLAP BASS	31	CHORUS HARD WOOD BASS	71
WARM STRINGS	32	FLUTE	73
CHORUS WARM STRINGS	33	CHORUS FLUTE	74
VOICE ENSEMBLE	35	MUTE TRUMPET	75
CHORUS VOICE ENSEMBLE	36	CHORUS MUTE TRUMPET	76
CHORUS JAZZ GUITAR	37	CHORUS TIGHT BRASS	77
JAZZ GUITAR	38	SAX	78
CHORUS BANJO	39	CHORUS SAX	79
CHORUS BELL	40	TUBA	81
HARD ELECTRIC BASS	41	CLARINET	82

Sending and Receiving Program Numbers

TONE	Program No.	TONE	Program No.
CHORUS HARD ELECTRIC BASS	42	CHORUS CLARINET	83
SOFT ELECTRIC BASS	43	OBOE	84
CHORUS SOFT ELECTRIC BASS	44	CHORUS OBOE	85
HARMONICA	86	TIGHT BRASS	96
CHORUS HARMONICA	87	VIBRAPHONE	99
TRUMPET	88	BELL	100
CHORUS TRUMPET	89	SYNTHE. GLOCKEN	101
TROMBONE	90	CHORUS SYNTHE. GLOCKEN	102
CHORUS TROMBONE	91	MARIMBA	103
HORN	92	CHORUS MARIMBA	104
CHORUS HORN	93		



When the program number of an accompaniment tone is received, the keyboard tone does not change, only the MULTI-TIMBRE tone is switched. (Refer to page 5 -11 for more information about this.) Program numbers over 104 cannot be received.

Making the MIDI Connection

Sending Program Numbers with the ARRANGEMENT EXPANDER Dial

In addition to using **TONE** buttons to send program numbers, you can also send program numbers from 0 to 127 using the **ARRANGEMENT EXPANDER** dial.

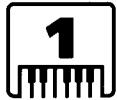

Press the **MIDI/SYSTEM** button.

The following message will appear on the display screen.

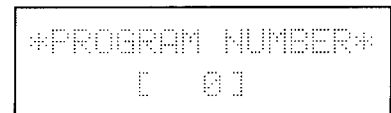
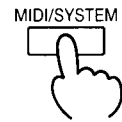

Select the program number to be sent using the **ARRANGEMENT EXPANDER** dial.

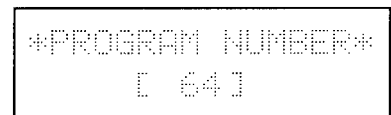

Press the **EXECUTE** button.

The PV35 will send the program number you selected to the receiving instrument.



Press the **MIDI/SYSTEM** button, or any one of the tone and rhythm buttons. The standard display will reappear, and the PV35 will leave the MIDI/SYSTEM mode. Or, as in the other modes, if you don't perform any operation within several seconds of entering MIDI/SYSTEM mode, the PV35 will leave that mode automatically.

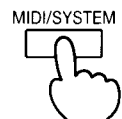

CHAPTER 4 Using the MULTI TIMBRE Mode

When the MULTI TIMBRE mode is on, the PV35 will be able to receive information on more than one MIDI channel and play the different tones of each channel simultaneously. Using this mode, you can connect the keyboard to sequencers such as the KAWAI Q80 to play ensembles composed of several tones.



Press the **MIDI/SYSTEM** button.

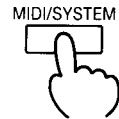

Select the MULTI TIMBRE display using the **TEMPO** (◀) and ▶) buttons.

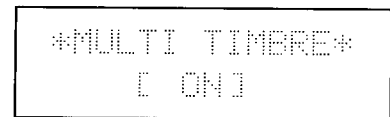
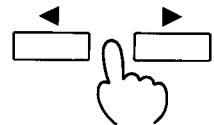

Turn the **ARRANGEMENT EXPANDER** dial to select ON or OFF.



When the MULTI TIMBRE mode setting is off, the PV35 will play in response to MIDI information received on the selected basic channel only. When it is ON, the PV35 will play the tones corresponding to the MIDI channel on which information is received as listed in the chart below, no matter what tone has been selected on the panel.

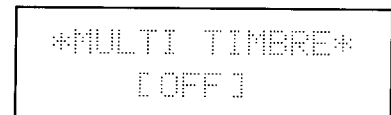

Making the MIDI Connection

MULTI TIMBRE Channel/Tone Correspondences

Channel	Tone	Channel	Tone
1	PIANO1	9	VOICE ENSEMBLE
2	PIANO2	10	HAND PERCUSSION
3	E. PIANO	11	STRING ENSEMBLE
4	CLAVI	12	ACOUSTIC GUITAR
5	JAZZ ORGAN	13	FLUTE
6	FULL ORGAN	14	WOOD BASS 1
7	HARPSICHORD	15	ELECTRIC BASS 1
8	VIBRAPHONE	16	SLAP BASS



When a program change message is received on a particular channel, however, the keyboard will play the tone corresponding to the program number in response to further note information from that channel. Please refer to page 5-7 for a list of program numbers and tone names.

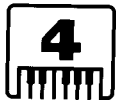

Press the **MIDI/SYSTEM** button or any one of the tone and rhythm buttons. The standard display will reappear, and the PV35 will leave MULTI TIMBRE mode

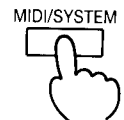

CHAPTER 5 Switching Local Control On and Off

Local control determines whether a sound is played when a key is struck. When local control is off, no sound is played when the keyboard of the PV35 is struck; only key note data received via MIDI is played.



Press the **MIDI/SYSTEM** button.

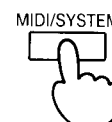

Select the **LOCAL CONTROL** display with the **TEMPO** (◀ and ▶) buttons.

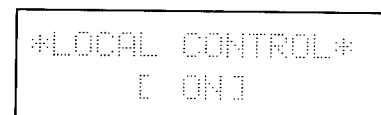
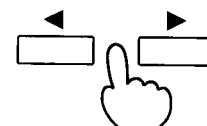

Turn the **ARRANGEMENT EXPANDER** dial to select **ON** or **OFF**.



The PV35 will produce sounds both when the keyboard is struck and when MIDI information is received when **LOCAL CONTROL** is set to on. When it is off, the PV35 will only produce sound in response to note information received via a MIDI channel.

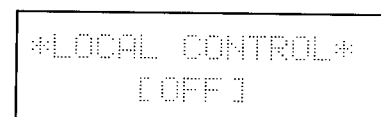

Press the **MIDI/SYSTEM** button, or any one of the tone and rhythm buttons. The standard display will reappear as the PV35 leaves **MIDI/SYSTEM** mode.

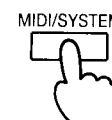

CHAPTER 6

Recording MIDI data (MULTI-REC)

The PV35 is equipped with a MULTI-REC function capable of simultaneously recording 16 channels of data from the MIDI IN terminal. Refer to page 5 – 2 for details on MIDI.



Press the **SONG SELECT** button, and then use the **ARRANGEMENT EXPANDER** dial to select the song number.



Press and then spin dial.



Press the **REPEAT** button while holding down the **RECORD** button. A "M" will be shown on the display.

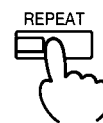

Press both at once.



Press the **PLAY/PAUSE** button to start recording.



Transmit the MIDI data from the connected MIDI musical instrument.



You can listen to and check incoming key data by setting the PV35 MIDI channel to the one you want to listen to.



After all data has been sent, press the **STOP** button to stop recording.

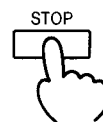





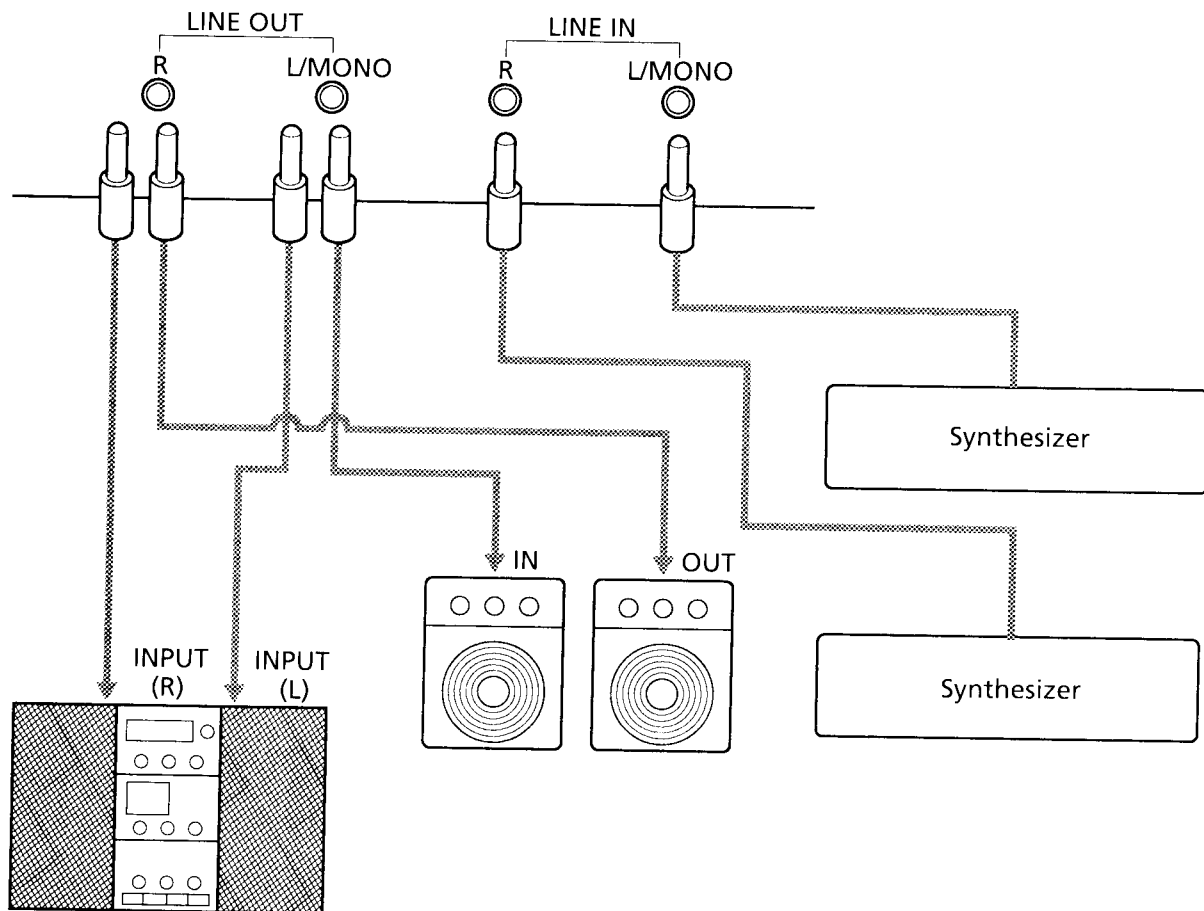

















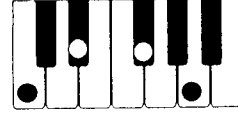

Appendix A Connection with Other Instruments

The PV35 is equipped with LINE IN and LINE OUT jacks. Use the LINE OUT jack to connect the keyboard to an external speaker or audio system, and use the LINE IN jack to play sounds from equipment such as synthesizers on the PV35's internal speaker. Since these are stereo jacks, the L/MONO jack should be used for monoral sound.



Appendix B Chord Forms

These are the chord patterns you can use to play the indicated chords with AUTO ACCOMPANIMENT. (Transpose up or down to get chords with other roots.)



C 	or		or	
Cm 	or			
C7 	or		or	
CM7 	or			
Cm7 	or			
Cdim 	or		C9 	
Csus4 	Caug 	C6 		
C7sus4 	CmM7 	Cm7-5 		
Cadd9 	C-9 	Cm9 		

Appendix C Troubleshooting

Symptom	Cause	What To Do
No sound, or very low volume.	A volume control is set to minimum.	Increase the master, tone, rhythm, chord or bass volume sliders until the sound is right.
	The headphones are plugged in.	The headphones must be unplugged before sound will come out of the main speakers.
	SONG data or MEMORY REGISTRATION data was read in which set the volume to minimum.	Manually changing the volume controls will override the volume settings that were read in.
	LOCAL CONTROL is set to OFF.	Set LOCAL CONTROL to ON. See page 5 – 13 for details.
Only one tone can be heard in DUAL or SPLIT modes.	The disk is being formatted.	Wait until the format process is over.
	The DUAL/SPLIT BALANCE slider is set all the way to one side or the other.	Move the DUAL/SPLIT BALANCE slider more towards the middle.
ONE FINGER AD-LIB or AUTO MELODY CHORD are not working.	You are trying to use both these features at the same time.	ONE FINGER AD-LIB and AUTO MELODY CHORD cannot be used simultaneously.
	The SPLIT POINT has been set somewhere to the right of the playable keyboard.	Reset the SPLIT POINT. See page 1 – 6 for details.
Can't save REGISTRATION MEMORY. (Only available menu option is RHYTHM LOAD.)	A rhythm pattern data disk is being used.	Switch to a song data disk.
Can't enter MIDI/SYSTEM, SONG SELECT or DISK modes.	You're already in one of the other modes.	Leave the mode you're currently in, and try again.
Can't save, delete, or copy to a disk.	The write-protect tab is set to ON.	Slide the tab the other way, and try again.
Can't record HAND PERCUSSION.	You're trying to use a track other than Track 10.	Record HAND PERCUSSION only on Track 10.
No sound using MIDI.	The MIDI channels for transmitting and receiving are set incorrectly.	Set the MIDI channels for transmitting and receiving correctly.

Appendix D Error Messages

The PV35 displays the following error messages when it cannot write information to a floppy disk.

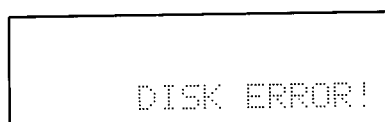
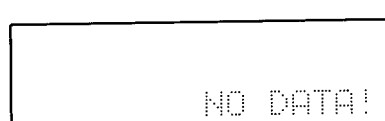
Error message	Cause
	The disk's write protect window is open. Close the window and try again.
	The disk does not have enough room left to hold the new data you attempted to store. Store the data on a new disk.
	The disk has not been formatted, or has been scratched or soiled and is unusable. Format the disk or use a new disk.
	The disk does not have any data to execute. Insert the right disk.

Appendices

INDEX

- A**
Arrangement expander 1 – 15, 3 – 6
Arrangement expander dial 1 – 15
Arrangement number 1 – 2
Auto accompaniment 1 – 12
Auto fill in 1 – 11
Auto melody chord 1 – 18
- B**
Basic channel 5 – 6
Brilliance 1 – 4
- C**
Cents 3 – 3
Characters, Available for display 4 – 10
Chord forms Ap. – 2
Chord hold 3 – 6
Chorus 1 – 4
Copy 4 – 15
- D**
Damper pedal 3 – 7
Delete 4 – 13
Disk error Ap. – 4
Disk full Ap. – 4
Disk library 2 – 9
Disk rhythms 2 – 8
Dual mode 1 – 5
- F**
Fast forward (FF) 2 – 5
Fill in 1 – 11
Format 4 – 2
- H**
Hand percussion 1 – 19, 2 – 17
- I**
Into/Ending 1 – 9, 3 – 5
- L**
Left pedal 3 – 5
Letters and Characters, Available for display
..... 4 – 10
List 4 – 4, 4 – 6
Load 3 – 13
Local control 5 – 13
Lower keyboard 1 – 7, 1 – 13, 1 – 18
- M**
MIDI 5 – 2
MIDI channels 5 – 3
Multi-Rec 5 – 14
Multi timbre 5 – 11
Multi-track recording 2 – 16
- N**
Name 4 – 8, 4 – 11
No data 4 – 4, Ap. – 4
- O**
One finger ad-lib 1 – 16
- P**
Pedal assign 3 – 5
Program number 5 – 7
Protected 2 – 2, Ap. – 4
- R**
Registration memory 3 – 9
Repeat 2 – 4
Reverb 3 – 8
Rewind 2 – 5
Rhythms 1 – 9
- S**
Save 3 – 11
Soft pedal 3 – 5
Song 2 – 4
Song copy 4 – 15
Song delete 4 – 13
Song select mode 2 – 4
Split mode 1 – 6
Split point 1 – 12, 1 – 7
Start/stop 1 – 9, 3 – 5
Sync. intro 1 – 10
Sync. start 1 – 9
S-tuning curve 3 – 4
- T**
Tempo 1 – 2
Tracks 2 – 16, 2 – 18
Transpose 3 – 2
Tune 3 – 3
Tuning curve 3 – 3
- U**
Upper keyboard 1 – 6, 1 – 18
- V**
Variation 1 – 9

TECHNICAL DATA

Number of keys:	Full 88-key keyboard
Max. different notes:	32
Tones of Upper key:	Piano 1 and 2, Electric Piano 1 and 2, Clavi, Jazz Organ, Full Organ, Harpsicord, Vibraphone, Acoustic Guitar, Jazz Guitar, Flute, Sax, Voice Ensemble, String Ensemble, Brass
Tones of Lower key:	Wood Bass 1 and 2, Electric Bass 1 and 2, Slap Bass, Synth. Bass, Tuba
Rhythms:	Pops, Disco, 16 Beat, Rock n' Roll, Shuffle, Country, Swing, Ballad, Samba, Bossanova, Waltz, March, up to 4 Disk Rhythms
Rhythm Features:	Start/Stop, Fill In 1, 2 and 3, Intro/Ending, Synch. Start, Auto Fill In, Variation
Effects:	Brilliance, Chorus, Reverbs (Room, Studio, Live House, Concert Hall, Church, Cosmic Delay, Space Delay)
Disk Functions:	Record (up to 16 tracks), PLAYBACK, FF, REW, List, Name, Song Delete, Song Copy
Volume Controls:	Separate controls for Master, Tone, Rhythm, Chord and Bass volume, and Dual/Split Balance
Other Features:	Auto accompaniment, Auto melody chord, One finger ad-lib, Dual and Split keyboards, Hand percussion, Registration memory, Transpose
Pedals:	Left pedal (can perform Soft, Start/Stop, Intro/Ending, Fill In 1, 2, or 3, Chord hold, Arrangement Expander functions, as set by Pedal Assign), Damper pedal (can be applied to upper keyboard only, Lower keyboard only, or Lower and Upper)
Ext. Connections:	Headphone, MIDI (In, Out, Thru), Line In (L/Mono, R), Line Out (L/Mono, R)
Output Power:	30 W x 2
Built-in Speakers:	2 x 16cm speakers, 2 x 5cm speakers
Power Consumption:	130 W
Finish:	Cosmo Black
Dimensions:	143 x 57 x 86 cm (including stand)
Weight:	73.6 kg (including stand)
Accessories:	Music stand, Playback Instructions Sheet (1), Floppy disk (rhythm patterns, songs) (1), Sheet music (1)

Model : PV35

MIDI Implementation Chart

Version :1.0

Function . . .		Transmitted	Recognized	Remarks
Basic	Default	1	1	
Channel	Changed	1 - 16	1 - 16	
Mode	Default	3	1	** Refer to Notes below.
	Messages	X	1, 3 **	
	Altered	*****	X	
Note Number		21 - 108 *	0 - 127	
	True Voice	*****	15 - 113	
Velocity	Note ON	9nH V=1-127		
	Note OFF	X 9nH v=0	X	
After Touch	Key's	X	X	
	Ch's	X	X	
Pitch Bend		X		
	7			Volume pedal
	64	(Right pedal)		Damper pedal
Control Changes	66	(Center pedal)	X	Sostenuto pedal
	67	(Left pedal)		Soft pedal
Prog Change	True #	(0 - 127) *****	(0 - 127)	
System Exclusive				
Common	: Song Pos	X	X	
	: Song Sel	X	X	
	: Tune	X	X	
System Real Time	: Clock			
	: Commands			
Aux Messages	: Local ON/OFF	X		
	: All Notes OFF			
	: Active Sense			
	: Reset	X	X	

Notes

- * Note numbers 15 through 113 can be transmitted using the transposed function
- ** Automatically set to OMNI ON when power is turn on. Switched to OMNI OFF when a MIDI channel setting is made.

Mode 1 : OMNI ON, POLY Mode 2 : OMNI ON, MONO : Yes

Mode 3 : OMNI OFF, POLY Mode 4 : OMNI OFF, MONO X : No

KAWAI

Kawai Musical Instruments Manufacturing Co., Ltd.
200 Terajima-cho, Hamamatsu, Japan

OW914E-C
Printed in Japan

Free Manuals Download Website

<http://myh66.com>

<http://usermanuals.us>

<http://www.somanuals.com>

<http://www.4manuals.cc>

<http://www.manual-lib.com>

<http://www.404manual.com>

<http://www.luxmanual.com>

<http://aubethermostatmanual.com>

Golf course search by state

<http://golfingnear.com>

Email search by domain

<http://emailbydomain.com>

Auto manuals search

<http://auto.somanuals.com>

TV manuals search

<http://tv.somanuals.com>