

DVD DVD
DVD DVD

Kawasaki™

PVS1112

Portable DVD Player with 10" LCD Display

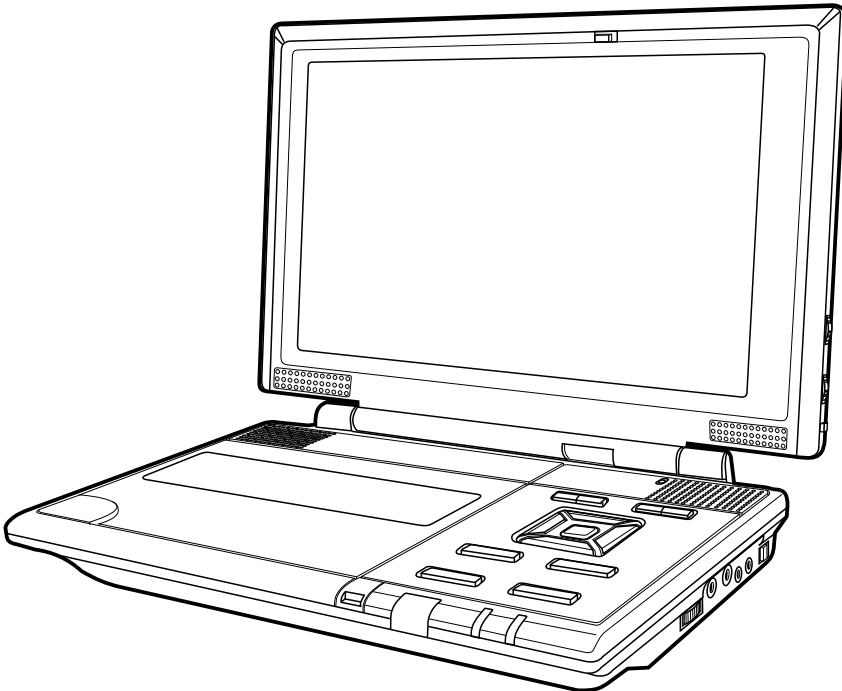

OWNER'S MANUAL

Download from www.Somanuals.com. All Manuals Search And Download.

SAFETY PRECAUTIONS



WARNING: TO REDUCE THE RISK OF ELECTRIC SHOCK, DO NOT REMOVE COVER (OR BACK). NO USER-SERVICEABLE PARTS INSIDE. REFER SERVICING TO QUALIFIED SERVICE PERSONNEL.

WARNING: TO PREVENT FIRE OR SHOCK HAZARD, DO NOT EXPOSE THIS APPLIANCE TO RAIN OR MOISTURE.

CAUTION: TO PREVENT ELECTRIC SHOCK, MATCH WIDE BLADE OF PLUG TO WIDE SLOT, FULLY INSERT.

DANGER OF EXPLOSION IF BATTERY IS INCORRECTLY REPLACED. REPLACE ONLY WITH THE SAME OR EQUIVALENT TYPE.



The lightning flash with an arrowhead symbol, within the equilateral triangle, is intended to alert the user to the presence of uninsulated "dangerous voltage" within the product's enclosure that may be of sufficient magnitude to cause an electric shock.



The exclamation point within the equilateral triangle is intended to alert the user to the presence of important operating and maintenance (servicing) instructions in this owner manual.



The symbol for Class II (Double Insulation)



This product contains a low power laser device.

On Placement

- Do not use the unit in places which are extremely hot, cold, dusty, or humid.
- Do not restrict the air flow of the unit by placing it in a place with poor air flow, by covering it with a cloth, or by placing it on carpeting.

FCC Information

This device complies with Part 15 of FCC Rules.

Operation is subject to the following two conditions:

- (1) This device may not cause harmful interference, and
- (2) This device must accept any interference received, including interference that may cause undesirable operation.

On Safety

- When connecting or disconnecting the AC power cord, grip the plug and not the cord itself. Pulling the cord may damage it and create a hazard.
- When you are not going to use the unit for a long period of time, disconnect the AC power cord.

On Condensation

- When left in a heated room where it is warm and damp, water droplets or condensation may form inside the unit. When there is condensation inside the unit, the unit may not function normally. Let the unit stand for 1 to 2 hours before turning the power on, or gradually heat the room up and dry the unit before use.

Rating Plate Location

- The rating plate is located is on the bottom of unit.

WARNING:

- Should any trouble occur, disconnect the AC power cord and refer servicing to a qualified technician.

Notes on Copyright

It is forbidden by law to copy, broadcast, show, broadcast on cable, play in public, rent copyrighted material without permission.

Apparatus Claims of U.S. Patent Nos. 4,631,603; 4,577,216; 4,819,098 and 4,907,093 licensed for limited viewing uses only.

DVD video discs are copy protected, and any recordings made from these discs will be distorted. This product incorporates copyright protection technology that is protected by method claims of certain U.S. patents and other intellectual property rights owned by Macrovision Corporation and other rights owners. Use of this copyright protection technology must be authorized by Macrovision Corporation, and is intended for home and other limited viewing uses only, unless otherwise authorized by Macrovision Corporation. Reverse engineering or disassembly is prohibited.

IMPORTANT SAFETY INSTRUCTIONS

1. **Read Instructions** - All the safety and operating instructions should be read before the appliance is operated.
2. **Retain Instructions** - The safety and operating instructions should be retained for future reference.
3. **Heed Warnings** - All warnings on the appliance and in the operating instructions should be adhered to.
4. **Follow Instructions** - All operating and use instructions should be followed.
5. **Water and Moisture** - The appliance should not be used near water - for example, near a bathtub, washbowl, kitchen sink, laundry tub, in a wet basement, or near a swimming pool, and the like.
6. **Carts and Stands** - The appliance should be used only with a cart or stand that is recommended by the manufacturer.
- 6A. An appliance and cart combination should be moved with care. Quick stops, excessive force, and uneven surfaces may cause the appliance and cart combination to overturn.
7. **Wall or Ceiling Mounting** - The appliance should be mounted to a wall or ceiling only as recommended by the manufacturer.
8. **Ventilation** - The appliance should be situated so that its location or position does not interfere with its proper ventilation. For example, the appliance should not be situated on a bed, sofa, rug, or similar surface that may block the ventilation openings; or, placed in a built-in installation, such as a book case or cabinet, that may impede the flow of air through the ventilation openings.
9. **Heat** - The appliance should be situated away from heat sources such as radiators, heat registers, stoves, or other appliances (including amplifiers) that produce heat.
10. **Power Sources** - The appliance should be connected to a power supply only of the type described in the operating instructions or as marked on the appliance.
11. **Grounding or Polarization** - Precautions should be taken so that the grounding or polarization means of an appliance are not defeated.
12. **Power-Cord Protection** - Power-supply cords should be routed so that they are not likely to be walked on or pinched by items placed upon or against them, paying particular attention to cords at plugs, convenience receptacles, and the point where they exit from the appliance.
13. **Cleaning** - The appliance should be cleaned only as recommended by the manufacturer.
14. **Nonuse Periods** - The power cord of the appliance should be unplugged from the outlet when left unused for a long period of time.
15. **Object and Liquid Entry** - Care should be taken so that objects do not fall, and liquids are not spilled, into the enclosure through openings.
16. **Damage Requiring Service** - The appliance should be serviced by qualified service personnel when:
 - A. The power-supply cord or the plug has been damaged; or
 - B. Objects have fallen, or liquid has been spilled, into the appliance; or
 - C. The appliance has been exposed to rain; or
 - D. The appliance does not appear to operate normally or exhibits a marked change in performance; or
 - E. The appliance has been dropped, or the enclosure damaged.
17. **Servicing** - The user should not attempt to service the appliance beyond that described in the operating instructions. All other servicing should be referred to qualified service personnel.



TABLE OF CONTENTS

Safety Precautions	1	Repeat Playback	16
Important Safety Instruction	2	Repeating a title/chapter (DVD)	16
Table Of Contents	3	Repeating a single track/whole disc (CD)	16
Disc Formats	4	Repeating a specific section (DVD)	16
Accessories	5	Playing MP3/Digital Picture Files	17
Remote Control	5	Playing a MP3 / Picture file disc	17
Control Reference Guide	6-7	Customizing the Function	
Power Supply	8-10	Settings	17-18
Using the AC adaptor	8	LANGUAGE setting	17
Using the car power adaptor	8	VIDEO setting	17-18
Using the rechargeable battery pack	9-10	RATING setting	18
Turning on the unit	10	Language Code List for	
Connecting other Equipment	11-12	Disc Language	19
Connecting Game Consoles or other Video		Maintenance	20
Equipment	11	Cleaning Disc	20
Connecting a TV	11	Cleaning the Unit	20
Connecting to an amplifier or stereo receiver	12	Important Note	20
Using headphone/earphones	12	Trouble Shooting Guide	21
Adjusting the Sound	12		
Playing a Disc	13-15		
Playing Disc	13		
Pausing playback (still mode)	13		
Stopping playback	13		
Skipping to a different track	13		
Fast Foward/Fast Reverse	13		
Skip (Forward/Reverse)	13		
Audio selection	14		
Subtitle selection	14		
Angle selection	14		
Special Functions	15		
Display function	15		
Locating a specific title	15		
Locating a specific title /chapter/track	15		
Locating a specific time	15		
CD / DVD programmable memory	16		
DVD programmable memory	16		
CD programmable memory	16		

DISC FORMATS

The unit can playback.



DVDs
[8cm/12cm disc]

CD-R CD-RW
Compatible



Audio CDs
[8cm/12cm disc]



Region Management Information

Region Management Information: This unit is designed and manufactured to respond to the Region Management Information that is encoded on DVD discs. If the Region number printed on the DVD disc does not correspond to the Region number of this unit, this unit cannot play that disc.







The region number of this unit is 1.

Disc Function or Operation that is Not Available

When the  symbol appears on the screen, it indicates that the function or operation attempted is not available at that time. This occurs because the DVD disc manufacturer determines the specific functions. Certain functions may not be available on some discs. Be sure to read the documentation provided with the DVD.

Icons Used on DVDs

Sample Icons

	1. English 2. French	— Language selections for audio
	1. English 2. French	— Language selections for subtitles
	LB	— Screen aspect ratio
	2	— Multiple camera angles
		— Region code indicator

Note:

- When playing back a CD-G (Graphics) or CD EXTRA disc, the audio portion will be played, but the graphic images will not be shown.

Title, Chapter and Tracks

- DVDs are divided into “titles” and “chapters”. If the disc has more than one movie on it, each movie would be a separate “title”. “Chapters” are sections of titles.
- Audio CDs are divided into “tracks”. A “track” is usually one song on an Audio CD.

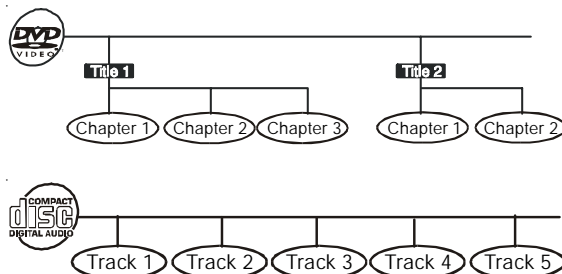

Note :

- Numbers identify each title, chapter, and track on a disc. Most discs have these numbers recorded on them, but some do not.

Notes on Unauthorized Discs

You may not be able to play back some DVD discs on this unit if they were purchased from outside your geographic area or made for business purposes.

ACCESSORIES

Please check and identify the supplied accessories.

- Remote control (with battery) x 1
- AC adaptor x 1
- AC power cord x 1
- Car power adaptor x 1
- Audio/Video cable x 1
- Rechargeable battery pack x 1
- Earphones x 1

REMOTE CONTROL

Using the Remote Control

- Point the Remote Control at the REMOTE SENSOR located on the unit.
- When there is a strong ambient light source, the performance of the infrared REMOTE SENSOR may be degraded, causing unreliable operation.
- The recommended effective distance for remote operation is about 16 feet (5 meters).

Gently remove the plastic sheet before operating the Remote Control.

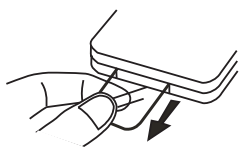

TO CHANGE REMOTE BATTERY

1. Open the battery door.
2. Insert one CR2025 (3V) size battery.

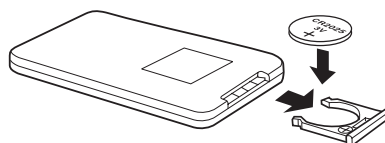
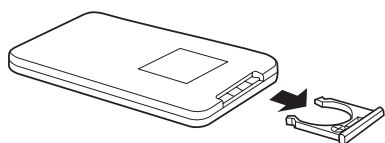

BATTERY REPLACEMENT

When the battery becomes weak, the operating distance of the Remote Control will be greatly reduced and you will need to replace the battery.

NOTE:

- If the Remote Control is not going to be used for a long time, remove the battery to avoid damage caused by battery leakage or corrosion.
- **WARNING:** Do not dispose of battery in a fire, or it may explode.

CONTROL REFERENCE GUIDE

Remote Control

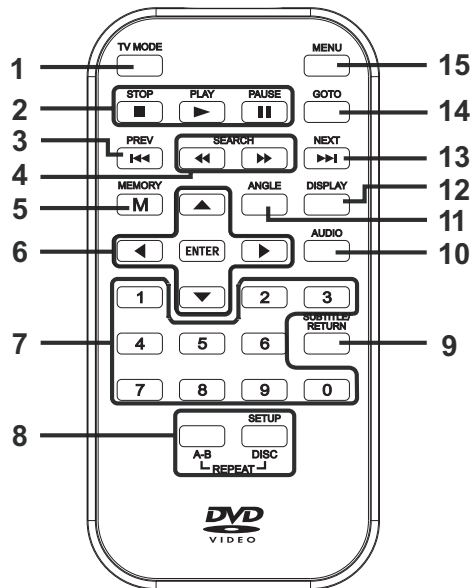

1) TV MODE button

In stop mode, select whether to output the video signal in PAL or NTSC. When the TV shows "AUTO" this means the output signal depends on the DVD. If the TV shows "PAL" or "NTSC" it means the output signal is fixed to either "PAL" or "NTSC".

2) ■ STOP button

Stop playing a disc.

▶ PLAY button

Press to start or resume playback a disc.

■ PAUSE button

Pause playback, frame advance.

3) ◀◀ PREV button

Move back through titles, chapters or tracks on a disc.

4) ◀◀ / ▶▶ SEARCH buttons

◀◀ SEARCH: Fast reverse playback.

▶▶ SEARCH: Fast forward playback.

5) MEMORY button

In stop mode, enter the number of a selected chapter or track.

6) Cursor (▼, ▲, ◀, ▶) buttons

Use to highlight selections on a menu screen and adjust certain settings.

ENTER button

Confirm selections on a menu screen.

7) Number (0 - 9) buttons

Use when creating programmes, and entering a parental level password. Also use to select a CD track directly.

8) SETUP button

In stop mode, open and close the SETUP menu.

REPEAT A-B button

Perform point-to-point repeat playback on a DVD or CD.

REPEAT DISC button

Repeat chapter or title of a DVD.
Repeat single track or whole CD.

9) SUBTITLE button

Select one of the subtitle languages programmed on a DVD.

RETURN button

Return to the normal operation after using the SETUP menu of a DVD.

10) AUDIO button

Select one of the audio sound tracks programmed on a DVD or select the audio output mode on an AUDIO CD.

11) ANGLE button

Switches between multiple camera angles when the DVD you are playing has multiple camera angles recorded.

12) DISPLAY button

Change disc status information displayed on the screen.

13) ▶▶ NEXT button

Move forward through titles, chapters or tracks on a disc.

14) GOTO button

Skip directly to a location on a DVD.









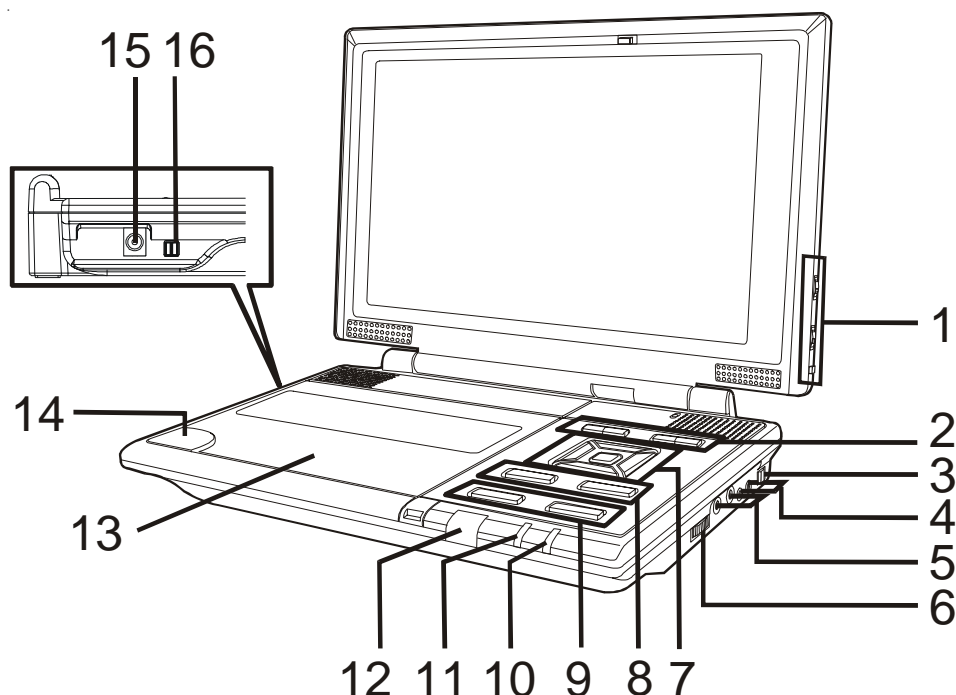





15) MENU button

Open and close DVD menu.

CONTROL REFERENCE GUIDE

Unit



- 1) **BRIGHTNESS switch**
Adjust the lightness or darkness of the screen.
COLOR control
Adjust the color intensity.
SCREEN switch
Wide: Wide screen
Normal: Normal screen
- 2) **ANGLE button**
During DVD playing, switch the camera angle of the video presentation when scenes with multiple camera angles are recorded on a DVD.
AUDIO button
Select one of the audio soundtracks programmed on a DVD or select the audio output mode on a AUDIO CD.
MENU button
Enter or return to the DVD's menu.
PAUSE  button
Press to pause playback of disc. Each time you press the PAUSE button the picture advances one frame. Press the PLAY  button to resume playback.
- 3) **AV IN / DVD switch**
Select between the DVD player or an external video source.
- 4) **AUDIO & VIDEO IN /OUT jacks**
- 5) **Headphone jacks**
Connect one or two headphones
- 6) **VOLUME control**
Adjust the volume.
- 7) **Cursor (, , , ) button**
Use to highlight selections on a menu screen and adjust certain settings.
ENTER () button
Confirm selections on a menu.
- 8) ** PREV button**
Press  PREV button to go back to previous chapters /tracks. Press and hold  PREV button for fast reverse. Four speeds are available.
 NEXT button
Press  NEXT button to advance to chapters / tracks. Press and hold  NEXT button to begin fast forward. Four speeds are available.
- 9) ** STOP button**
Stop playing a disc.
 PLAY button
Press to start or resume playing a disc.
- 10) **BATTERY LOW indicator**
- 11) **Power ON indicator**
When the **POWER ON/OFF** switch is turned to ON position, the light will illuminate.
- 12) **Remote sensor**
Receives the remote control signal.
- 13) **Disc Door**
Close door by gently pushing down.
- 14) **Open button**
Push the button to open the disc door.
- 15) **DC IN 9V/Car Plug-12V jack**
- 16) **POWER ON/OFF switch**

POWER SUPPLY

A. Using the AC adaptor

This AC adaptor operates on AC power between 110V and 240V, but

- In the USA and Canada, the AC power supply cord must be connected to a 120V AC power supply only.
- When connecting to an AC supply outside of the USA and Canada, use a plug adaptor to suit the AC outlet configuration.

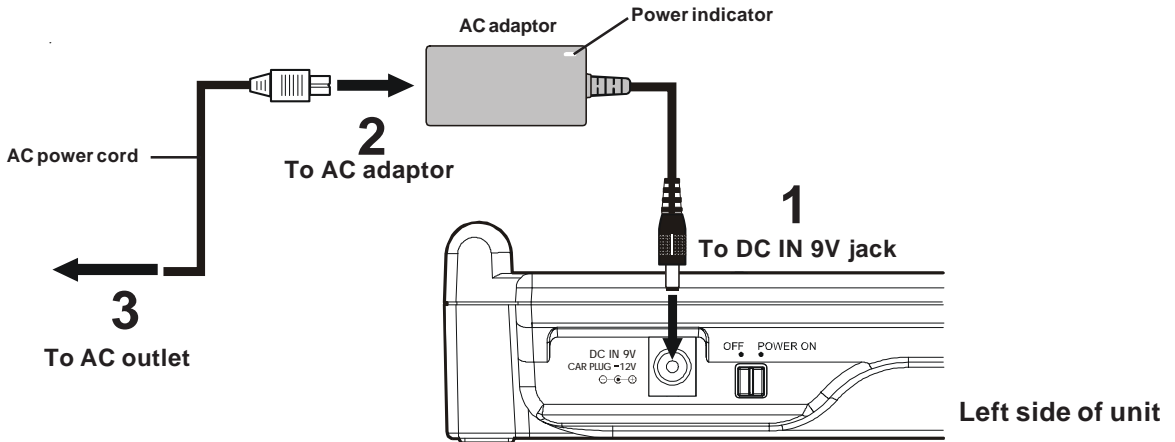

Cautions:

- The included AC power supply cord and AC adaptor are for use with this unit only. Do not use them with other equipment.
- **To prevent electrical shock, match wide blade of plug to wide slot of electrical outlet and fully insert.**
- When the unit is not going to be used for long time, disconnect the power cord from the outlet.

B. Using the Car power adaptor

The included car power adaptor is designed for use with vehicles that have a 12V, negative ground electrical system.

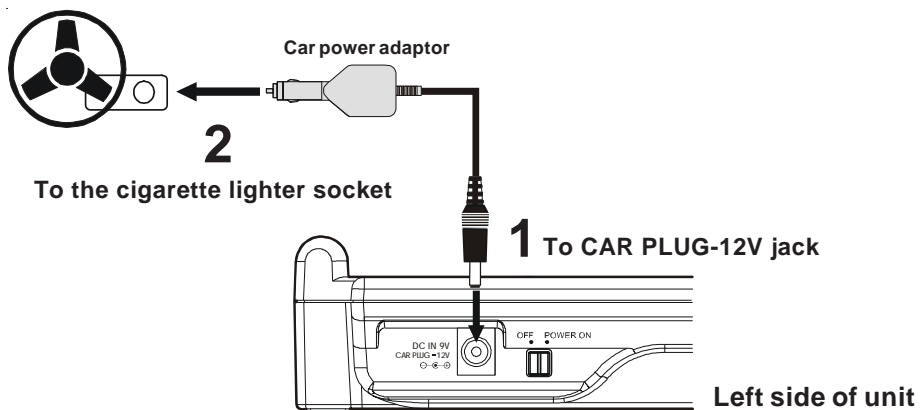

Cautions:

- Use this unit only with the car power adaptor, use with other car power adaptor could damage the unit.
- The car power adaptor are for use with this unit only. Do not use them with other equipment.
- In the interests of the traffic safety, do not perform operations on the unit or view video software while driving a vehicle.
- Make sure the unit is fastened correctly to prevent from falling in the vehicle in the event of an accident.
- When the inside of the cigarette lighter socket is dirty with ashes or dust, the plug section may become hot due to poor contact. Be sure to clean the cigarette lighter socket before use.
- After use, disconnect the car power adaptor from both the unit and cigarette lighter socket.

POWER SUPPLY

C. Using the rechargeable battery pack

- Charge the rechargeable battery before using it for the first time. The normal charging time should be completed at least 4-5 hours. The green charging light will go out when the battery becomes fully charged.
- The rechargeable battery is suitable when adapting the unit for portable use and when it is convenient for you to enjoy the unique functions of the unit out of doors.

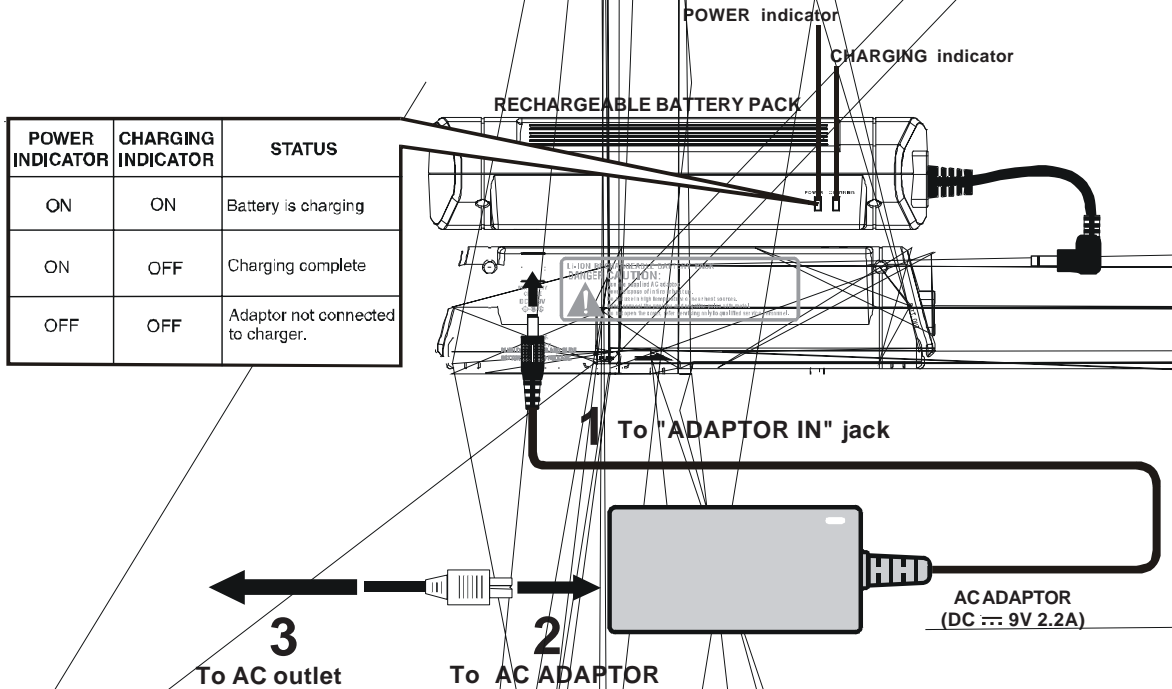

Warning:

- The rechargeable battery cannot be recharged either by using the 12V car-plug or when the unit is ON.

Caution:

- The included AC power supply cord and AC adaptor are for use with this unit only. Do not use them with other equipment.
- **To prevent electrical shock, match wide blade of plug to wide slot on electrical outlet and fully insert.**
- When the unit is not going to be used for a long time, disconnect the AC power supply cord from the AC outlet.
- Recharging is complete when charging indicator goes out. Unplug the AC power supply cord from the AC adaptor, then unplug the battery pack from the battery charger.
- To install rechargeable battery pack, slide it in to the corresponding direction on the back of the unit.

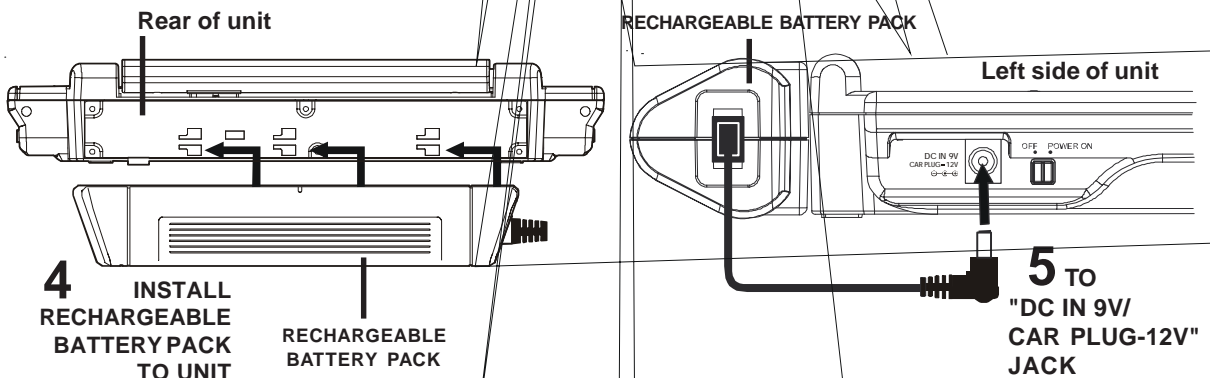

POWER SUPPLY

■ Disconnecting the Battery Pack from the unit.

Push the button to disconnect the RECHARGEABLE BATTERY PACK

RECHARGEABLE BATTERY PACK

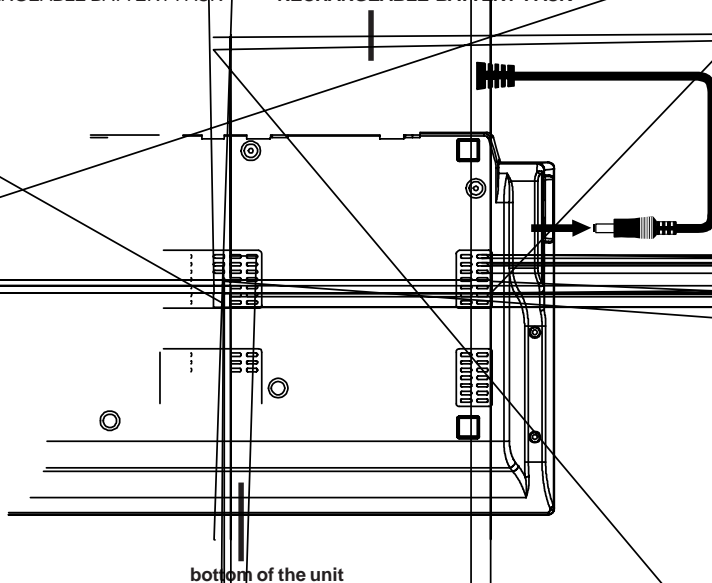

Condition and attention:

- When battery is low, unit will stop operating.
- During playback, if the battery is low, the BATTERY LOW indicator on the front will turn red and blink. When this occurs, you should recharge the battery.
- Do not short-circuit the terminals.
- Recharge the battery when you are ready to use it again.
- While using the rechargeable battery, the environmental temperature should be 5°C (41°F) to 35°C (95°F).
- To get the longest service life of the rechargeable battery, charge at indoor-temperature.
- Never dispose the battery in fire or water. Never heat up the rechargeable battery.
- Do not open the rechargeable battery, refer servicing only to qualified service personnel.
- Detach the battery pack when not in use. (Even if the unit is off, it still uses some power. This can completely discharge the battery and cause it to malfunction.)

Turning on the unit

1. Slide the **POWER ON/OFF** switch on the left side of unit to the **POWER ON** position.
2. Slide the **AV IN / DVD** switch to **DVD** or **AV IN** mode on the right side of unit.
 - If you select **DVD** the DVD logo (start-up picture) will appear on the screen.



CONNECTING OTHER EQUIPMENT

Using this Unit with Other Equipment

A. Connecting Game System or other Video Equipment

- You can connect a Game System or other Video Equipment to the system.

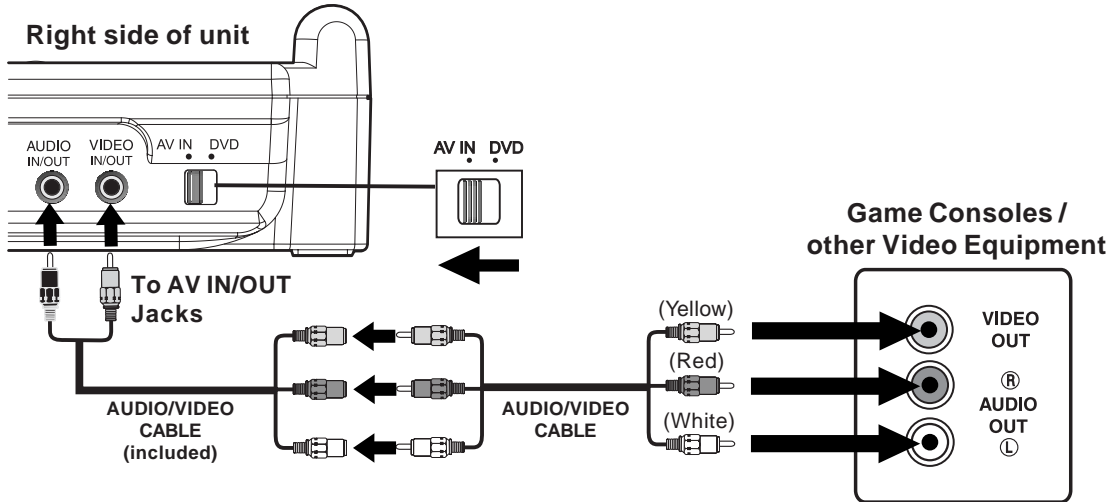

Using a Game System or other Video Equipment

1. Turn on the unit, slide the **AV IN / DVD** switch to "AV IN".
2. Turn on the video equipment and follow the instructions provided with it.

Note: If you are using a mono VCR, the volume level from the speakers will be low.

B. Connecting a TV

- If your TV has Audio/Video inputs, you can connect the unit to your TV using the Audio/Video cable.

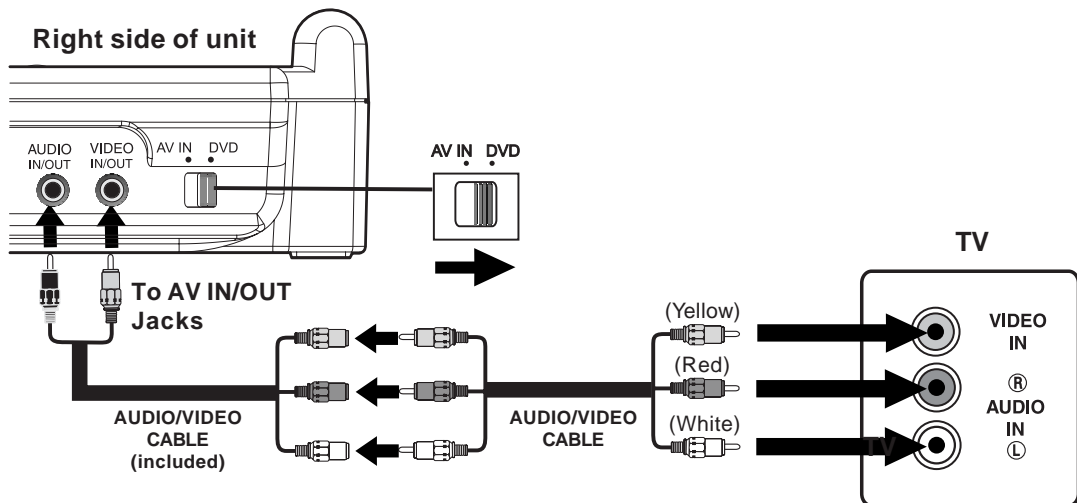

Watching a DVD on your TV

1. Turn on the unit, slide the **AV IN / DVD** switch to select "DVD".
2. Turn on the TV and follow the instructions provided with it to play the DVD.

Note: Please use the corrected Audio/Video cable.

CONNECTING OTHER EQUIPMENT

C. Connecting to an amplifier or stereo receiver

This unit can play Dolby Digital, but only in two channels.

Analog connection

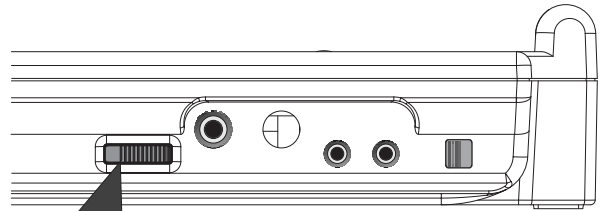
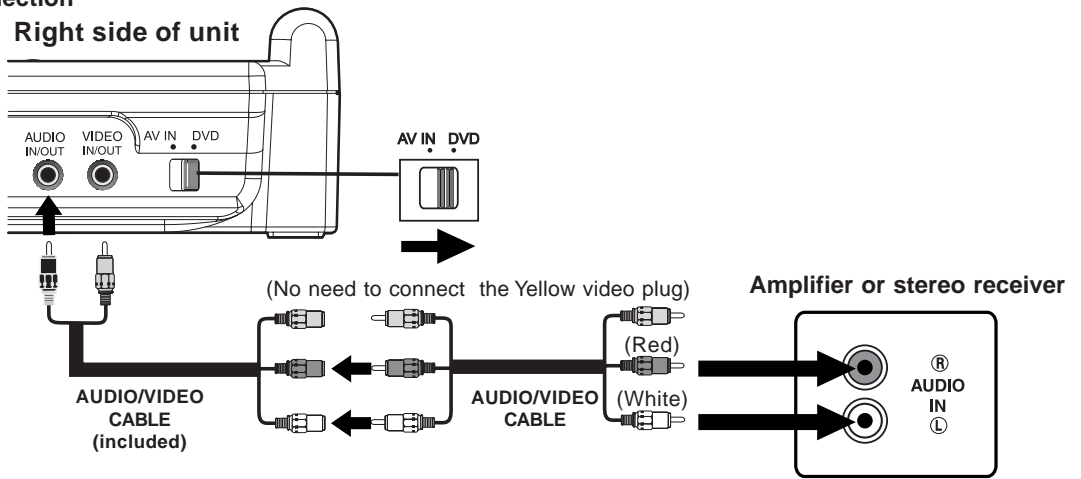

This owner's manual explains the basic instructions of this unit. Some DVD discs are produced in a manner that allows specific or limited operation during playback. As such, the unit may not respond to all operating commands. This is not a defect in the unit. Refer to the instructions accompanying the DVD disc.

“” may appear on the screen during operation. A “” means that the desired operation is not permitted by the unit or disc.

Playing a Disc

1. Slide the **POWER ON/OFF** switch on the left side of unit to POWER ON.
2. Slide the **AV IN / DVD** switch on the right side of unit to select DVD mode.
See **CUSTOMIZING THE FUNCTION SETTINGS** before proceeding to step 3.
3. Push the **OPEN** button to open the disc door.
4. Hold the disc by its sides and carefully place it onto the central spindle in the disc compartment, with the label side facing up; press the disc down until you hear a “click”.
5. Push the door to close.
It takes a short while for your unit to load the disc. After loading, the unit will automatically start playing most DVDs.
6. If the DVD does not start automatically, press the **▶ PLAY** button.

Pausing playback (still mode)

Press the **|| PAUSE** button. To resume normal playback, press the **▶ PLAY** button.

Stopping playback

Press the **■ STOP** button to interrupt playback. To resume playback, press the **▶ PLAY** button. If you press the **■ STOP** button twice, the unit's memory will be cleared and pressing the **▶ PLAY** button will reset the disc to the beginning.

Skipping to a different track

- Press the **◀◀ PREV** button repeatedly to skip to the start of the current or previous track.
- Press the **▶▶ NEXT** button to skip to the next track.
- For audio CD disc, use the number buttons (remote control only) to jump to a particular track number.

Fast Forward/Fast Reverse

1. Press the **SEARCH ▶▶** or **◀◀ SEARCH** button when a disc is playing.
 - The disc begins a fast scan at two times normal (x2) speed.
 - Four speeds are available. Each time the **SEARCH** button is pressed, the speed of the fast scan changes in the following sequence:



Note:

- You also can press and hold **◀◀ / ▶▶ (PREV/NEXT)** buttons repeatedly to select different fast scan speeds.
2. Press the **▶ PLAY** button when you reach the desired point to resume playback at normal speed.

SKIP (Forward / Reverse)

While you are playing a disc, press the **▶▶ NEXT** button to move to the beginning of the next chapter or track. Press the **◀◀ PREV** button to move to the previous chapter or track and automatically start playing it.

Audio selection

On some discs, the sound is recorded in two or more formats. Follow the directions below to select the type of playback.

1. While a disc is playing, press the **AUDIO** button to show the current audio format number.
2. Press the **AUDIO** button repeatedly to select the desired audio format.

Notes :

- If only one audio format is recorded, the number does not change.
- About two seconds later, playback continues in the new audio format.

Subtitle selection

1. While a DVD is playing, press the **SUBTITLE / RETURN** button to display the current language setting, as shown in the example below.
2. Press the **SUBTITLE / RETURN** button repeatedly to select the desired subtitle language.

Notes :

- If only one language is recorded, the language does not change.
- About two seconds later, playback continues with the new subtitle you selected.
- The number of languages recorded differs depending on the disc.
- If no button is pressed within a few seconds, playback continues without changing the current subtitle.
- This function can only be used for discs on which subtitles have been recorded in multiple languages.
- On some DVDs, subtitles are activated from the main menu of the DVD. Press the **MENU** button to activate the main menu.

Angle selection

Some DVDs contain scenes which have been shot from a number of different angles. For these discs, the same scene can be viewed from each of these different angles.

1. While you are playing a DVD with different angles recorded, press the **ANGLE** button to view the number of the current angle available.

2. Press the **ANGLE** button repeatedly to change the scene to the next recorded angle.
 - After approx. two seconds, playback will continue from the new angle you selected.
 - If no button is pressed within 10 seconds, playback continues without changing the current angle.

Sequence of angle shots (Example)

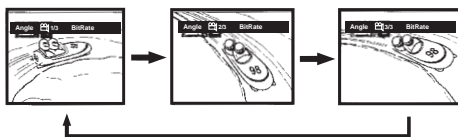

Notes:

- This function can only be used for discs on which scenes shot from multiple angles have been recorded.
- If only one angle is recorded, "Angle 1/1" is displayed.

DISPLAY function

Using DISPLAY, you can check the current settings of the following items: ANGLE, AUDIO and SUBTITLE.

- While the disc is playing, press the **DISPLAY** button to display the screen shown below.
 - Elapsed time:** Elapsed time from the beginning of the chapter which is currently playing.
 - Remaining time:** Remaining time of the title which is currently playing.

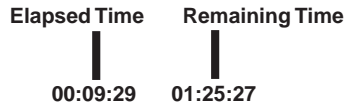

Locating a specific title

If a DVD contains title numbers, you can locate a specific title by directly selecting its title number.

1. In stop mode, press the **GOTO** button.
2. Press ◀ or ▶ button to highlight a specific field and press the corresponding number button(s) for the title you want.
3. Press the **ENTER** button to confirm. The unit will start playback about 3 seconds later.

Title/Chapter ---/---

Locating a specific title / chapter / track

If you know the title/chapter/track number for the title/chapter/track that you want to play, you can locate it by directly selecting that number.

1. Press the **GOTO** button to search for your desired title/chapter/track.
2. Press ◀ or ▶ button to highlight a title/chapter/track and press the corresponding number button(s) for the chapter you want.
3. Press the **ENTER** button to confirm. The unit will start playback about 3 seconds later.

DVD Title/Chapter ---/---

CD Track ---

Locating a specific time

You can move to a specific location by entering its corresponding time (hours, minutes, seconds)

1. Press the **GOTO** button.
2. Press ◀ or ▶ button to highlight time.
3. Press the corresponding number buttons for the setting point you want.
4. Press the **ENTER** button to confirm. The unit will start playback about 3 seconds later.

Time --:--:--

Notes :

- Some discs may not respond to this process.
- Some scenes may not be located as precisely as you specified.
- This method for accessing specific locations is available only within the current title of the DVD disc.

CD/DVD PROGRAMMABLE MEMORY

Programmable memory

The two types of programmed playback provided by this Unit are title programmed playback and chapter programmed playback.

Title / Chapter programmed playback

1. Press the **MEMORY** button while the disc is stopped.
2. Enter the title numbers in **■**. Use **◀** or **▶** button to highlight your desired chapter and enter the chapter numbers in **■**.
3. Use **◀**, **▶**, **▲** or **▼** button to move to another field.
4. Repeat steps 2 to 3.
5. Press the **▶ PLAY** button to start the programmed playback.

Note :

- If you press the **■ STOP** button twice, the programmed selections will be cleared.

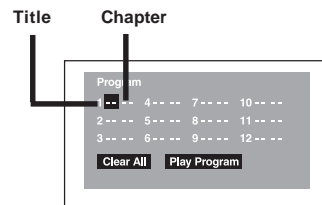

Track programmed playback

1. Press the **MEMORY** button while the disc is stopped.
2. Enter the track numbers in **---**.
3. Use **◀**, **▶**, **▲** or **▼** button to move to another field.
4. Repeat steps 2 to 3.
5. Press the **▶ PLAY** button to start the programmed playback.

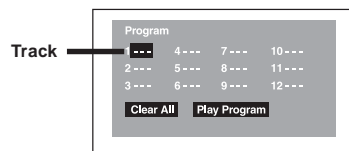

You can play a specific title or chapter repeatedly.
(Title repeat, chapter repeat, A-B repeat)

Repeating a chapter

You can play the same chapter repeatedly.

1. While the disc is playing, press the **REPEAT DISC** button until the "Repeat Chapter" indicator displays on the screen. The current chapter is played repeatedly.

Repeating a title

You can play the same title repeatedly.

2. While the disc is playing, press the **REPEAT DISC** button until the "Repeat Title" indicator displays on the screen. The current title is played repeatedly.

To resume normal playback

3. While the disc is playing, press the **REPEAT DISC** button until the "Off" indicator displays on the screen.

You can play a single track or the whole DVD repeatedly.

Repeating a single track

You can play the same track repeatedly.

1. While the disc is playing, press the **REPEAT DISC** button until the "Repeat Single" indicator displays on the screen. The current track is played repeatedly.

Repeating a whole disc

2. While the disc is playing, press the **REPEAT DISC** button until the "Repeat All" indicator displays on the screen. The whole disc is played repeatedly.

To resume normal playback

3. Press the **REPEAT DISC** button until the "off" indicator displays on the screen.

Repeating a specific section

You can play a specific section repeatedly.

1. While the disc is playing, press the **REPEAT A-B** button at the beginning of the section ((Rep A-B) is displayed) you want to play repeatedly.
2. Press the **REPEAT A-B** button again at the end of the section ((Rep A-B) is displayed).
3. The Unit will immediately begin replaying your selection.
3. Press the **REPEAT A-B** button again at the beginning of the section ((Rep A-B) is displayed) you want to play repeatedly.

PLAYING MP3 AND PICTURE FILE DISC

This unit can play MP3 and Picture files recorded on CD-R and CD-RW discs.

Playing an MP3/Picture file disc

1. Open the disc door.
2. Hold an MP3 /Picture file disc by its edge and gently push it onto the spindle with the label side facing up you until you hear a "click".
3. Close the disc door.
4. The unit will load the disc and automatically display the contents of the disc on the screen, while also beginning to play the first MP3 file or Picture files will be playback one by one.
5. Press the ▲, ▼, ◀ or ▶ **CURSOR** button to view and select the files that you want to listen to, then press the **ENTER** button to confirm the selected file.

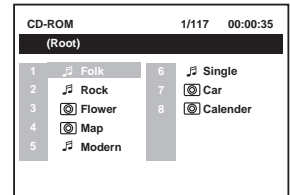

Notes:

- You can press the **II PAUSE** button to interrupt playback, and press the **▶ PLAY** button to resume playback.
- You also can use the **GOTO** function or use the numbered buttons to enter a photo number and quickly select any image.
- Press the **ANGLE** button on the remote control to rotate the picture orientation by 90°.

Playable files

The ability of this unit to read MP3 discs is dependent on the following:

- The Bit Rate must be within 64 - 256 kbps.
- The total number of files on the disc should not exceed 254.
- The maximum number of directories should not exceed 32.
- The maximum depth level of directories should not exceed 4.
- File names should be named using 7 or fewer letters and/or numbers, and must incorporate the "MP3" file extension. EXAMPLE: *****.MP3 where each * is a letter or number.
- Use only letters and / or numbers in file names. If you use special characters, the file and/or folder names may not be displayed correctly on the on-screen display.
- When recording on CD-R discs, use 74-minute (650MB) discs.
- The CD-R or CD-RW discs should be "finalized" on the computer using "single session format" with recording speed less than "8x".
- See your CD/MP3 creation software for more information.

CUSTOMIZING THE FUNCTION SETTINGS

LANGUAGE setting

1. Press the **SETUP** button in stop mode.
2. Use ▲ or ▼ button to select a language, then press the **ENTER** button. The screen will change to your selected language immediately.
3. To exit the SETUP MENU and return to the normal screen, press the **RETURN** or **SETUP** button.

Language

English

Deutsch
Français
Español
Italiano
Svenska
Português

VIDEO setting

1. Press the **SETUP** button in stop mode.
2. Use ◀ or ▶ button to select **Video**, then press the **ENTER** button.
3. Use ▲ or ▼ button to select the options (**TV Shape**, **Brightness** or **Edges**) to be adjusted by press ▲ or ▼ button, then press the **ENTER** button. (The screen will change to your desired setting).
4. Repeats step 2 and 3 above to adjust other options.
5. To exit the FUNCTION SETUP MENU and return to the normal screen, press the **RETURN** or **SETUP** button.

Video

TV Shape
Brightness
Edges

Letter Box

Off
Off

CUSTOMIZING THE FUNCTION SETTINGS

Pan Scan

- When wide-screen video is played, this mode clips the right and left sides of the image so that it can be viewed on a conventional screen.
- Some wide-screen DVDs that do not permit Pan Scan mode playback are automatically played in letterbox mode (black bands top and bottom).

Letter Box

- When wide-screen video is played in this mode on a conventional screen, black bands appear at the top and bottom of the screen.

Wide-screen

- This is the correct mode for playing wide-screen videos on a wide-screen.

Notes :

- The visible picture size is preset on the DVD disc. Therefore the playback picture of some DVD discs may not conform to the picture size you select.
- When you play DVD discs recorded in the 4:3 aspect ratio, the playback picture will always appear in the 4:3 aspect ratio regardless of the TV shape setting.

Cut off when a wide-screen video image is played.

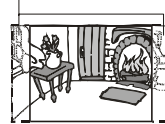

Pan Scan



Letter Box



Wide-screen

Rating

DVD discs equipped with a password function and are rated according to their content. The contents allowed by parental lock level and the way a DVD disc is controlled may vary from disc to disc. For example, if the disc allowed, you could lock-out violent scenes unsuitable for children or you could lock out playback of the disc altogether.

1. Press the **SETUP** button in stop mode.
2. Use ◀ or ▶ button to select the **Rating**, press the **ENTER** button.
3. Use ▲ or ▼ button to select parental lock and then press the **ENTER** button repeatedly to set the parental lock level.
4. Use ▲ or ▼ button to shift and select Password, enter your 4-digit security code and then press the **ENTER** button.

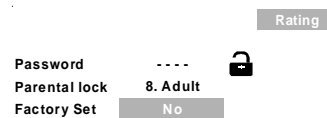

You cannot play DVD discs rated higher than the level you selected unless you cancel the parental lock function.

The parental lock levels are equivalent to the following ratings.

Level 1 : Kid Safe	Level 5 : PG_R
Level 2 : G	Level 6 : R
Level 3 : PG	Level 7 : NC_17
Level 4 : PG_13	Level 8 : Adult

 Indicates Parental lock is NOT active.

 The Parental lock is active.

If you forget the password, you can erase your current password by pressing number button 8 on the remote four times, then press the ENTER button to confirm the setting.

PASSWORD : 8 8 8 8

Note:

It takes 3-5 seconds to reset the unit to the factory default.

LANGUAGE CODE LIST FOR DISC LANGUAGE

Code	Language Name	Code	Language Name	Code	Language Name	Code	Language Name
AA	Afar	FY	Frisian	MG	Malagasy	SL	Slovenian
AB	Abkhazian	GA	Irish	MI	Maori	SM	Samoaan
AF	Afrikaans	GB	Scots Gaelic	MK	Macedonian	SN	Shona
AM	Ameharic	GL	Galician	ML	Malayalam	SO	Somali
AR	Arabic	GN	Guarani	MN	Mongolian	SQ	Albanian
AS	Assamese	GU	Gujarati	MO	Moldavian	SR	Serbian
AY	Aymara	HA	Hausa	MR	Marathi	SS	Siswat
AZ	Azerbaijani	HI	Hindi	MS	Malay	ST	Sesotho
BA	Bashkir	HR	Croatian	MT	Maltese	SU	Sundanese
BE	Byelorussian	HU	Hungarian	MY	Burmese	SV	Swedish
BG	Bulgarian	HY	Armenian	NA	Nauru	SW	Swahili
BH	Bihari	IA	Interlingua	NE	Nepali	TA	Tamil
BI	Bislama	IE	Interlingue	NL	Dutch	TE	Telugu
BN	Bengali	IK	Inupiak	NO	Norwegian	TG	Tajik
	Bangla	IN	Indonesian	OC	Occitan	TH	Thai
BO	Tibetan	IS	Icelandic	OM	(Afan) Oromo	TI	Tigrinya
BR	Breton	IT	Italian	OR	Oriya	TK	Turkmen
CA	Catalan	IW	Hebrew	PA	Panjabi	TL	Tagalog
CO	Corsican	JA	Japanese	PL	Polish	TN	Setswana
CS	Czech	JI	Yiddish	PS	Pashto, Pushto	TO	Tonga
CY	Welsh	JW	Javanese	PT	Portuguese	TR	Turish
DA	Danish	KA	Georgian	QU	Quechua	TS	Tsonga
DE	German	KK	Kazakh	RM	Rhaeto-	TT	Tatar
DZ	Bhutani	KL	Greenlandic		Romance	TW	Twi
EL	Greek	KM	Cambodian	RN	Kirundi	UK	Ukrainian
EN	English	KN	Kannada	RO	Romanian	UR	Urdu
EO	Esperanto	KO	Korean	RU	Russian	UZ	Uzbek
ES	Spanish	KS	Kashmiri	RW	Kinyarwanda	VI	Vietnamese
ET	Estonian	KU	Kurdish	SA	Sanskrit	VO	Volapük
EU	Basque	KY	Kirghiz	SD	Sindhi	WO	Wolof
FA	Persian	LA	Latin	SG	Sangho	XH	Xhosa
FI	Finnish	LN	Lingala	SH	Serbo-	YO	Yoruba
FJ	Fiji	LO	Laothian		Croatian	ZH	Chinese
FO	Faroese	LT	Lithuanian	SI	Singhalese	ZU	Zulu
FR	French	LV	Latvian, Lettish	SK	Slovak		

MAINTENANCE

Cleaning Disc

A defective or soiled disc inserted into the unit can cause sound to drop out during playback.

Handle the disc by holding its inner and outer edges.

- Do NOT touch the surface of the unlabeled side of the disc.
- Do NOT stick paper or tape on the surface.
- Do NOT expose the disc to direct sunlight or excessive heat.
- Clean the disc before playback. Wipe the disc from the center outward with a cleaning cloth.
- NEVER use solvents such as benzine or alcohol to clean the disc.
- Do NOT use irregular shaped discs (example : heart shaped, octagonal, etc.). They may cause malfunctions.

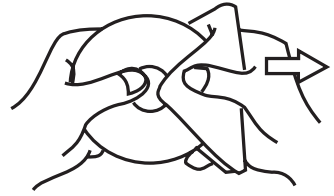

Cleaning the unit

- Be sure to turn the unit off and disconnect the AC power cord before maintaining the unit.
- Wipe the unit with a dry soft cloth.
If the surfaces are extremely dirty, wipe clean with a cloth which has been dipped in a weak soap-and-water solution and wrung out thoroughly, then wipe with a dry cloth.
- Never use alcohol, benzine, thinner, cleaning fluid or other chemicals. Do NOT use compressed air to remove dust.

Important Note

Before transporting the unit, remove disc from the disc compartment.

TROUBLESHOOTING GUIDE

SYMPTOM

CAUSE (AND REMEDY)

No power.

- Check that the AC adaptor and AC power cord is connected.
- Turn on the unit.

The remote does not function.

- Remove any obstacles between the remote and the unit.
- Use the remote near the unit.
- Point the remote at the remote sensor on the unit.
- Replace the battery in the remote.

DVD

No sound or only a very low-level sound is

TICKET

- Make sure that you've select DVD mode.
- The system is in pause mode or in Slow-motion Play mode. Press the ► **PLAY** button to return to normal play mode.
- Fast forward or fast reverse is performed. Press the ► **PLAY** button to return to normal play mode.
- Make sure that AUDIO/VIDEO output and AV IN input connections are correct.
- The DTS DVD disc cannot be decoded for speaker output.
- This unit is too hot, shut off the unit for 30 minutes to cool down.

No picture

- The region number of the disc does not match the region number of the unit.



- DVD mode is not selected, select DVD on AV IN/DVD switch.

The picture is not clear

- Clean the disc.
- The disc is scratched.

Severe hum or noise is heard.

- The plugs and jacks are dirty. Wipe them with a cloth slightly moistened with alcohol.
- Clean the disc.

The disc does not play.

- There is no disc inside ("No Disc" appears on the screen).
- Insert the disc correctly with the playback side facing down on the disc tray.
- Clean the disc.
- A non-Valid disc has been inserted. The unit and disc region number are incompatible.
- Condensation may have formed inside the unit due to a sudden change in temperature. Wait about an hour for it to clear and try again.

Free Manuals Download Website

<http://myh66.com>

<http://usermanuals.us>

<http://www.somanuals.com>

<http://www.4manuals.cc>

<http://www.manual-lib.com>

<http://www.404manual.com>

<http://www.luxmanual.com>

<http://aubethermostatmanual.com>

Golf course search by state

<http://golfingnear.com>

Email search by domain

<http://emailbydomain.com>

Auto manuals search

<http://auto.somanuals.com>

TV manuals search

<http://tv.somanuals.com>