



"Serving Those Who Serve The Very Best"

# Users Manual

## PORTABLE FILTER

## MODELS PC14, LB-100, LB-65, LB-200

**READ AND SAVE THIS MANUAL FOR FUTURE REFERENCE.**

RECORD THE MODEL AND SERIAL  
NUMBERS OF THIS PORTABLE FILTER  
IN THE SPACES PROVIDED.

SERIAL NO. \_\_\_\_\_  
MODEL NO. \_\_\_\_\_

**KEEP THESE NUMBERS FOR FUTURE REFERENCE.**

**IMPORTANT:** Keep a copy of your bill of sale. The date on the bill establishes the warranty period should service be required. If service is performed, it is in your interest to obtain and keep all receipts. Keating commercial filters are not intended for household use.

The Owner's Guide provides specific operating instructions for your model. Use the Portable Filter only as instructed in this Owner's Guide.

### CONTENTS:

<b>OPERATING INSTRUCTIONS</b> .....	1-2
A: PREPARING THE PORTABLE FILTER .....	1
B: FILTRATION .....	1
C: CLEAN-UP .....	2
D: MELTING SOLID SHORTENING .....	2
E: FILTER FAILURE .....	2
<b>WARRANTY REPAIRS</b> .....	2
<b>SELF-HELP GUIDE</b> .....	3
PREVENTIVE MAINTENANCE .....	3
<b>SERVICE</b> .....	4-6
DISASSEMBLY .....	4

A: MELT/PUMP INDICATOR LIGHTS .....	4
B: MELT/PUMP ON/OFF SWITCH .....	4
C: MELT CYCLE SENSOR .....	4
D: HEATER ELEMENTS .....	5
E: PUMP AND MOTOR .....	5
F: HEAT TAPE .....	6
<b>PARTS LIST</b> .....	7-8
ORDERING PARTS .....	7
WARNING AND OPERATING PLATES .....	7
<b>WIRING DIAGRAMS</b> .....	9-13
<b>WARRANTY INFORMATION</b> .....	14

**\*AS CONTINUOUS PRODUCT IMPROVEMENT OCCURS, SPECIFICATIONS MAY BE CHANGED WITHOUT NOTICE.**

Keep this manual for training new personnel.





# PORTABLE FILTER OPERATING INSTRUCTIONS

## A. PREPARING THE PORTABLE FILTER

1. Remove screen from over tubes/element with tongs or a Drain Clean Out Rod (See Figure 1.1).

### CAUTION

**SCREEN OVER TUBES/ ELEMENTS WILL BE VERY HOT AND SHOULD BE MOVED TO A SAFE PLACE.**

2. Heat fryers to 325°F. Stir oil thoroughly until all water is removed and shut fryer off (including pilot light) before filtering. (Figure 1.2)

**NOTE:** Water settles in the cooler oil in the Cold Zone. If the water is not removed, the filter paper absorbs the water preventing the oil from passing through it.

### WARNING

**OIL IS HOT. USE CARE WHEN FILTERING.**

3. Place in clean filter tub (See Figure 1.3):

- 1st: Filter Screen
- 2nd: Filter Paper (new sheet for each fryer)
- 3rd: Hold down ring
- 4th: Secure hold down ring at each corner with "T" rod handles
- 5th: Acidox filter powder (new powder for each fryer)
- 6th: Strainer basket

**NOTE:** Hold down ring makes a gasket-like seal on filter paper. Filter paper must be placed edge to edge from front to back, overlapping on sides. Filter Paper must be smooth and flat under hold down ring to get a proper seal. Lock the two tension arms into place by pushing down and rotating 90°.

**NOTE:** One package of Acidox is needed for every 40 pounds of oil.

## B. FILTRATION

1. Place filter under fryer drain. Screw drain extension tube in to drain valve if desired. Open main drain valve and let oil flow completely into filter (See Figure 2.1).
2. Turn on pump and flush all crumbs from bottom of fryer into filter. Flush out fryer completely (See Figure 2.2).
3. Close fryer drain valve (See Figure 2.3).
4. Clean fryer vessel with non-abrasive scrub pad & Keating Klenzer.
5. Fill fryer with filtered oil by turning on pump and directing end of wand into vessel (See Figure 2.4).

**NOTE:** Filters with two-way pump - do NOT place wand in cold zone of fryer pot as it may pick up crumbs & other debris and excessively clog filter paper.



Figure 1.1: Remove screen over elements/ tubes

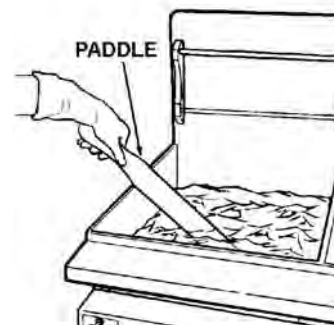

Figure 1.2: Stir with spoon to remove water

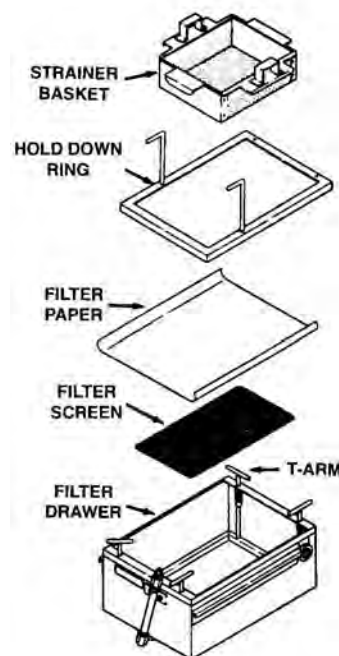

Figure 1.3: Assemble filter

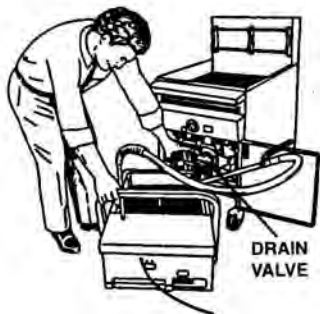

Figure 2.1: Drain fryer

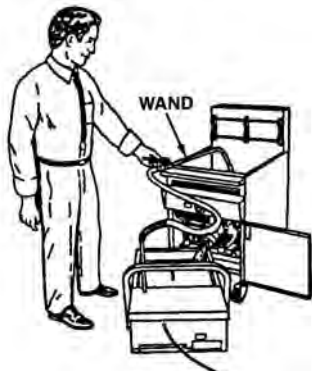

Figure 2.2: Flush out fryer

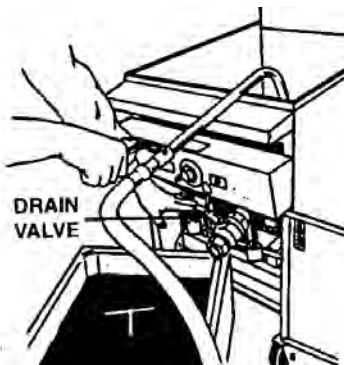

Figure 2.3: Close drain valve

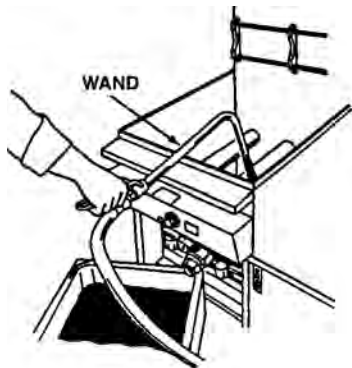

Figure 2.4: Fill fryer with filtered oil

## C. CLEAN-UP

### ⚠ WARNING

**FILTER UNIT AND PIPES WILL REMAIN HOT FOLLOWING FILTRATION. ALLOW THE UNIT TO COOL DOWN BEFORE CLEAN UP. FAILURE TO DO SO MAY RESULT IN SERIOUS INJURY TO THE OPERATOR.**

1. Turn off filter and disconnect from electrical source.
2. Remove strainer basket and hold down ring for cleaning
3. Remove and discard filter paper and any residue.
4. Clean filter tub thoroughly.
5. Coat inside of pump with oil if water has been running through it.
6. Place hose so that remaining oil will drain out.

## D. MELTING SOLID SHORTENING

1. Clean filter tub and remove all accessories.
2. Place a cube of shortening in filter tub.
3. Turn fat melter on. (50 lbs takes 1 hr to melt)
4. Once shortening is melted fill fryer with oil by turning on pump and directing end of wand into vessel (See Figure 2.4).

### ⚠ CAUTION

**DO NOT ALLOW SHORTENING TO SOLIDIFY IN FILTER AS IT WILL ALSO SOLIDIFY IN PIPES.**

### ⚠ CAUTION

**DO NOT TURN ON FAT MELTER WITHOUT SHORTENING IN TUB.**

## E. FILTER FAILURE

If filter will not pump, solidified shortening may have plugged pipes. Turn on fat melter for 20 minutes. This will heat filter tub and pipes to free system of solidified shortening. Reset motor before attempting filtering (reset button is located on rear of pump motor.)

### WARRANTY REPAIRS

Keating's 1 year parts & labor warranty begins with the date of installation. In the event that your filter, under warranty, needs repairs other than routine cleaning, you are requested to contact KEATING OF CHICAGO, INC. (1-800-KEATING) before calling a local service company. r of pump motor).

### ⚠ CAUTION

**HOT FLUID. DO NOT FILL  
BEYOND MAXIMUM FILL LINE  
LOCATED IN THE FRYER VESSEL.**

# SELF-HELP GUIDE

PROBLEM	PROBABLE CAUSE	SOLUTION (Follow Sequentially)
Motor runs but will not pump oil.	<p>A. Solidified shortening may have plugged pipes.</p> <p>B. Tub not set up properly.</p>	<p>Turn on fat melter for 20 minutes. This will heat filter tub and pipes to free system of solidified shortening. Reset motor before attempting filtering (reset button is located on rear of pump motor).</p> <p>Place components in tub per the following:</p> <ol style="list-style-type: none"> <li>1. Filter screen on the very bottom.</li> <li>2. Filter paper over filter screen (Lie it flat on the bottom, creasing the sides).</li> <li>3. Hold down ring (ensure paper is not folded, lock hold down ring into place ensuring a tight seal).</li> <li>4. Sprinkle Acidox powder evenly over filter paper (1 bag per 40 lbs. of oil).</li> <li>5. Strainer basket for large debris.</li> </ol>
Motor does not operate.	<p>A. Not plugged in.</p> <p>B. Motor has overheated.</p> <p>C. Motor pump is clogged.</p>	<ol style="list-style-type: none"> <li>1. Plug filter into a 120 or 220 Vac electrical power source.</li> <li>2. Turn ON/OFF switch to 'ON'.</li> </ol> <p>1. Allow motor to cool for approximately 10 minutes.</p> <ol style="list-style-type: none"> <li>2. Press the motor overload reset button and try again.</li> </ol> <p>1. Call a qualified service technician to clean your pump. Clogged motor pumps are not covered by warranty.</p>

Preventative maintenance should be performed during & after each use of the filter. Following preventative maintenance procedures will help to keep your filter working efficiently. Proper care & servicing will lead to years of quality performance.

## PREVENTIVE MAINTENANCE

Familiarize yourself with the proper filtering procedure prior to attempting to filter:

1. To remove water, stir oil until bubbling stops; water will clog filter paper pores.
2. Use only one sheet of filter paper properly sealed under hold down ring.
3. Do NOT turn on fat melt without oil in filter tub.
4. Use a drain clean out rod if partial or full blockage in fryer drain is suspected.
5. If filter was used for fryer boil out, run oil through filter to lubricate motor/pump.
6. Clean filter and all components after each use. Do not permit oil to remain in filter drawer; it will clog the pump.
7. Verify all lights and controls operate.
8. Adhere to operating instructions in sequence given for proper filtration.
9. Prepare filter for next use by using new filter paper and Acidox Powder for each fryer.

# SERVICE

## DISASSEMBLY

### You will need:

**Adjustable wrench**  
**Standard pliers**

**“Stubby” screwdriver**  
**Standard screwdriver**

Servicing should only be performed by qualified and licensed service companies. Always disconnect the electrical power cable before attempting any service

## **WARNING**

**The filter maybe hot; use care while servicing. As a safety precaution, it is recommended you drain oil from the filter vessel before performing any servicing.**

## A. MELT AND/OR PUMP INDICATOR LIGHTS

### Removal:

1. Disconnect filter from electrical power source.
2. Feel front end panel from bottom to locate rear of defective indicator light. Note two tangs that extend slightly beyond indicator light barrel diameter. Use a standard pliers to squeeze tangs together and pull indicator light free from panel. If indicator light doesn't release, squeeze tighter and break barrel to release electrical leads. Discard broken pieces.

### Replacement:

1. If necessary, clip off electrical leads as close as possible to indicator light. If leads were clipped, trim off insulation 1/8 inch from end.
2. With electrical leads extending through panel front, press them into recesses at rear of replacement indicator light to secure them in place. Press indicator light into panel until tangs engage to secure indicator light to panel.

## B. MELT AND/OR PUMP ON/OFF SWITCH

### Removal:

1. Disconnect filter from electrical power source.
2. Unscrew nut securing defective switch to panel. Push switch in to release from panel. Remove nameplate from front of panel.
3. Access to rear of switch through bottom hole under front end panel.
4. Disconnect leads from switch. Tag leads as they are disconnected to assure, during replacement, they are reconnected to the proper switch terminals.

### Replacement:

1. Connect tagged electrical leads to replacement switch.
2. Insert replacement switch through panel from which defective switch was removed. Insert nameplate over toggle and secure to panel with nut supplied with switch. Orient switch and tighten nut to secure in desired position.
3. Plug in filter power cord and operate switch to verify switch orientation corresponds to nameplate legend. If not, loosen attaching nut and reorient nameplate and/or switch as desired and retighten nut.

## C. MELT CYCLE SENSOR

### Removal:

1. Disconnect filter from electrical power source.
- NOTE:** Remove all oil from filter vessel. Filter must be positioned on its end to access melt cycle sensor.
2. Raise front (power cord) end of filter and rest filter on oil absorbing rags on its back end.
  3. Remove bottom cover attaching screws; remove bottom cover.
  4. Remove electrical leads from defective melt cycle sensor.
  5. Loosen heater element cover attaching nut adjacent to melt cycle sensor sufficiently to release melt cycle sensor and its retaining plate. Disengage melt cycle sensor.

### Replacement:

1. Orient replacement melt cycle sensor in its retaining plate such that the metallic sensing surface will be in direct contact with filter vessel. If necessary, reverse orientation of retaining plate.
2. Position retaining plate under heater element and tab on heater element cover with melt cycle sensor sensing surface in direct contact with filter vessel. Tighten loosened heater element attaching nut.
3. Attach removed electrical leads to melt cycle sensor. Verify terminals are not in contact with any metallic parts of filter vessel, heater cover or heater.
4. Secure bottom cover with removed attaching screws.
5. Position filter right-side-up and clean up oil absorbing rags.

### D. HEATER ELEMENT(S)

#### Removal:

1. Disconnect filter from electrical power source.
- NOTE:** Remove all oil from filter vessel. Filter must be positioned on its end to access heater element(s).
2. Raise front (power cord) end of filter and rest filter on oil absorbing rags on its back end.
  3. Remove bottom cover attaching screws; remove bottom cover.
  4. Remove electrical leads from defective heater element(s). Tag leads as they are disconnected to assure, during replacement, they are reconnected to the proper terminals.
  5. Loosen heater element(s) cover attaching nuts sufficiently to release defective heater element(s). Carefully remove heater element(s) being careful not to dislodge cover insulator(s).

#### Replacement:

1. Carefully position replacement heater element(s) between filter vessel and cover insulator(s).
2. Tighten loosened heater elements cover attaching nuts to secure heater element(s) in position against filter vessel.
3. Connect tagged electrical leads to heater element(s).
4. Secure bottom cover with removed attaching screws.
5. Position filter right-side-up and clean up oil absorbing rags.

### E. PUMP AND MOTOR

#### Removal:

1. Disconnect filter from electrical power source.
- NOTE:** Remove all oil from filter vessel. Filter must be positioned on its end to access pump and motor.
2. Disconnect hand hose assembly from quick disconnect on discharge port on defective pump and motor.
  3. Raise front (power cord) end of filter and rest filter on oil absorbing rags on its back end. Remove bottom cover.

4. Remove attaching screws securing front panel. Tilt back front panel to expose pump and motor.
5. Remove motor junction box cover and remove electrical leads from motor terminals. Tag leads as they are disconnected to assure, during replacement, they are reconnected to proper terminals.
6. Unscrew coupling nut securing suction tube under filter vessel from plumbing connected to pump and motor suction port. Oil absorbing rags should be available as some oil spillage should be expected.
7. While supporting pump and motor, remove attaching nuts, flat washers and screws; remove pump and motor. Note orientation of plumbing elbows at pump suction port and then unscrew these parts.
8. Remove motor junction box cover and disconnect electrical leads from motor terminals. Tag leads as they are disconnected to assure, during replacement, they are reconnected to the proper terminals.

#### Replacement:

1. Install removed plumbing parts into replacement pump and motor suction port in same orientation noted at removal using teflon tape or a good food grade pipe joint compound on male threads only of disassembled plumbing parts.
2. Position pump and motor onto its base and secure loosely with removed screws, flat washers and nuts.
3. Connect tagged electrical leads to motor terminals. Install motor junction box cover.
4. Tighten suction tube coupling nut onto mating pump suction port fitting. Then fully tighten pump and motor mounting hardware.
5. Position front panel onto frame and secure in position. Install bottom cover.
6. Position filter right-side-up and clean up oil absorbing rags.
7. Connect hand hose assembly to quick disconnect on discharge port.

## **F. HEAT TAPE**

### **Removal:**

1. Disconnect filter from electrical power source.

**NOTE:** Remove all oil from filter vessel. Filter must be positioned on its end to access heat tape.

2. Raise front (power cord) end of filter and rest filter on oil absorbing rags on its back end.
3. Remove bottom cover attaching screws; remove bottom cover.
4. Sketch course defective heat tape follows to assure oil and various components can be sufficiently heated during filter operation preventing any solidification. Then remove heat resistant mastic tape holding heat tape to filter components.
5. Remove hardware securing heat tape ends to electrical terminals. Unwind heat tape from filter components.

### **Replacement:**

1. Wind replacement heat tape onto and around filter components following same course of removed defective heat tape.
2. Secure heat tape ends to electrical terminals with removed hardware.
3. Use a heat resistant mastic tape to secure heat tape in place on filter components.
4. Secure bottom cover with removed attaching screws.
5. Position filter right-side-up and clean up oil absorbing rags.

# PORTABLE FILTER PARTS LIST

## ORDERING PARTS

Parts may be ordered by part number by calling your local service company or Keating at 1-800-KEATING. You may also order on-line at Keating's part store, [www.keatingofchicago.com](http://www.keatingofchicago.com).

Refer to the Keating Filter Limited Warranty for warranty service information.

The model/serial plate is located on the side of unit. The serial and model numbers are necessary when ordering.

## WARNING AND OPERATING PLATES

All warning and operating plates on the Keating Filter should be in place at all times.



## Supplies

Acidox Powder (30 lb case, 60 individual packages)	037524
Filter paper for LB-100 (60 papers)	058783
Filter paper for LB-165 or LB-200 (60 papers)	058781
Filter paper for PC14 (60 papers)	058779
Paddle Metal Spoon	029152
Sea Powder (for boiling out fryers), 4 jar case	000394
Sea Powder, 4 jar case (6 cases and up)	000395

## Parts - LB100 Model

Caster 3" swivel	000626
Caster 3" rigid	000627
Cover for LB-100 (2000 series)	056273
Cover for LB-100 (optional) (pre 2000 series)	000503
Filter screen LB-100 12 1/4" diameter	000591
Indicating Light - Amber	004158
Indicating Light - Red	000525
Handle for cover	004542
Heat Plate 500W 115V	000596
Heat Wrap Tape 4 ft. for LB and PC filters	012055
Hi-Limit Sensor	000694
Hold down Ring Handle	052817
Hold down Ring LB-100	000576
Hold down Ring LB-100 (after 1/2003)	054803
Hose 4 ft. with fittings and Stiffner Spring for PC14 (for LB filters prior to 2/3/93)	000569
Hose 5 ft. with fittings and Stiffner Spring (for LB filters after 2/3/93)	018157
Insulation Board	007694
Nozzle 90° with handle for LB and UFF filters	011816
Power Cord 6 ft. with Plug	033559
<b>**Pump/Motor (after 11/88)</b>	008196
<b>**Pump/Motor (after 2003)</b>	055173
Spring for T Handle	006656
Strainer Basket LB100 old style	000668
Switch (Pump-Off-Melt)	000521
Switch Reversing (2-way pump)	000527
Terminal Board	000639
Terminal Board Insulation	000263

## Parts - LB165 Model

Caster 3" swivel	000626
Caster 3" rigid	000627
Cord	055241
Cover for LB165	055676
Handle for cover	004542
Heat Plate 500W 115V	000596
Heat Wrap Wire 4 ft. 100W 120V	012055
Hi-Limit Sensor	000694
Hold Down Ring (pre 2000)	016121
Hold Down Ring (pre 2003)	054654
Hose (new style)	055038
Indicating Light - Amber	004158
Indicating Light - Red	000525
Insulation Board	007694
Power Cord Receptacle	055227
<b>**Pump/Motor (after 2004)</b>	055173
<b>**Pump/Motor (2003)</b>	052982
<b>**Pump/Motor (pre 2003)</b>	008196
Screen	001229
Spring for T Handle	006656

**\*\*Call 1-800-KEATING with serial # to determine correct part #.**



# PORTABLE FILTER **PARTS LIST**



## Parts - LB165 Model (continued)

Strainer Basket LB165	000677
Switch (Pump-off-melt)	000521
Switch Reversing (2-Way Pump)	000527
Terminal Block	002065
Terminal Board	000639
Terminal Board Insulation	000263

## Parts - LB200 Model

Caster 3" swivel	000626
Cover for LB200	056258
Handle for cover	004542
Heat Plate 500W 115V	000596
Heat Wrap Wire 4 ft. 100W 120V	012055
Hi-Limit Sensor	000694
Hold Down Ring (after 2004)	053033
Hold Down Ring (pre 2000)	016121
Hold Down Ring (pre 2003)	054654
Hose 5 ft. with fittings	055038
Indicating Light - Amber	004158
Indicating Light - Red	000525
Insulation Board	007694
Power Cord Receptacle	055227
<b>**Pump/Motor (after 2004)</b>	055173
<b>**Pump/Motor (2003)</b>	052982
<b>**Pump/Motor (pre 1993)</b>	008196
<b>**Pump/Motor (1993)</b>	010567
Screen	001229
Strainer Basket LB200	016305
Switch (Pump-off-melt)	000521
Switch Reversing (2-way pump)	000527
Valve (2-way pump)	000611
Terminal Board	000639
Terminal Board Insulation	000263

## Parts - PC14 Model

Caster 3" swivel	000626
Caster 3" rigid	000627
Cord Power 6 ft.	033559
Handle 'T'	010628
Heat Plate 500W 115V	000596
Heat Wrap Wire 4 ft. 100W 120V	012055
Hi-Limit Sensor	000694
Hold down Ring	011370
Hose 4 ft. with nozzle & fittings	017640
Indicating Light - Red	000525
Insulation Board	007694
Pump/Motor	008196
Screen	005871
Spring for 'T' Handle	006656
Strainer Basket PC14	012054
Switch (Pump-off-melt)	000521
Terminal Board	000639
Terminal Board Insulation	000263

**\*\*Call 1-800-KEATING with serial # to determine correct part #.**

# LB100, LB165, LB200 1 Way Pump - Part # 008196

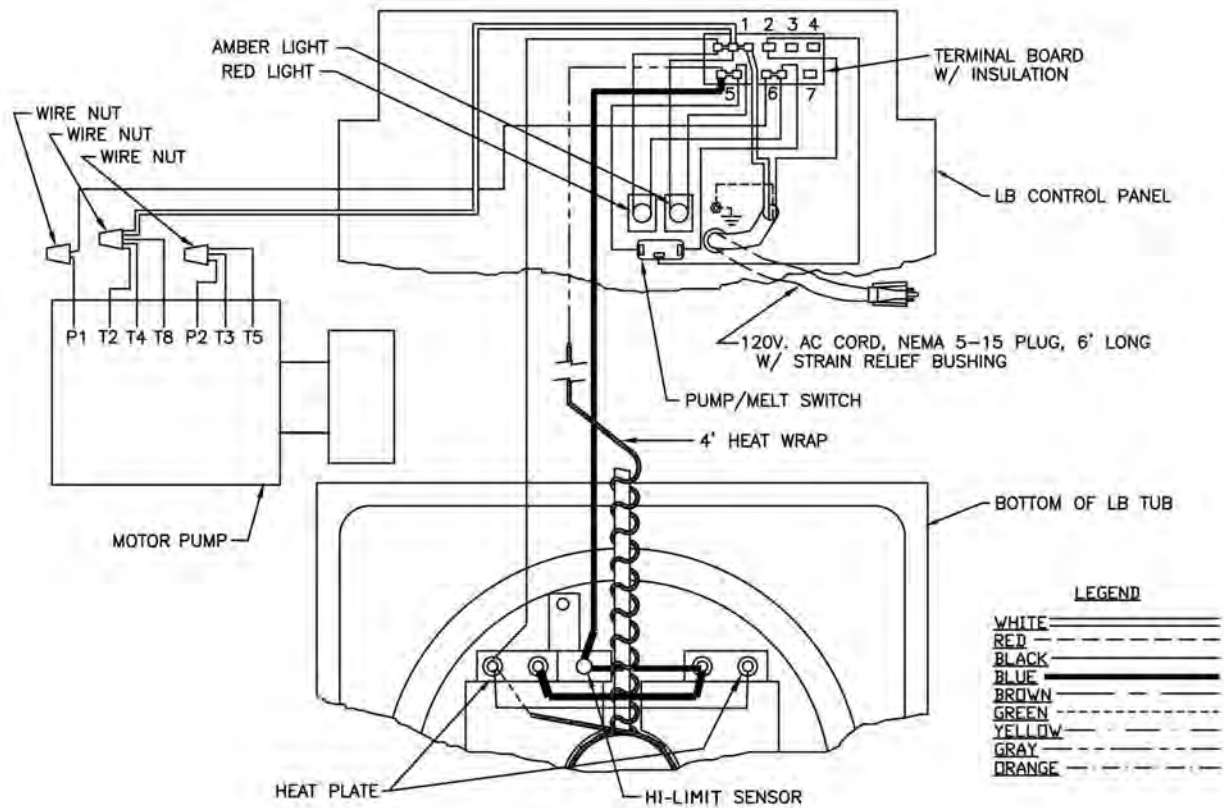

# LB100, LB165, & LB200 2 Way Pump - Pump Part # 055173 (1988 - 2002)

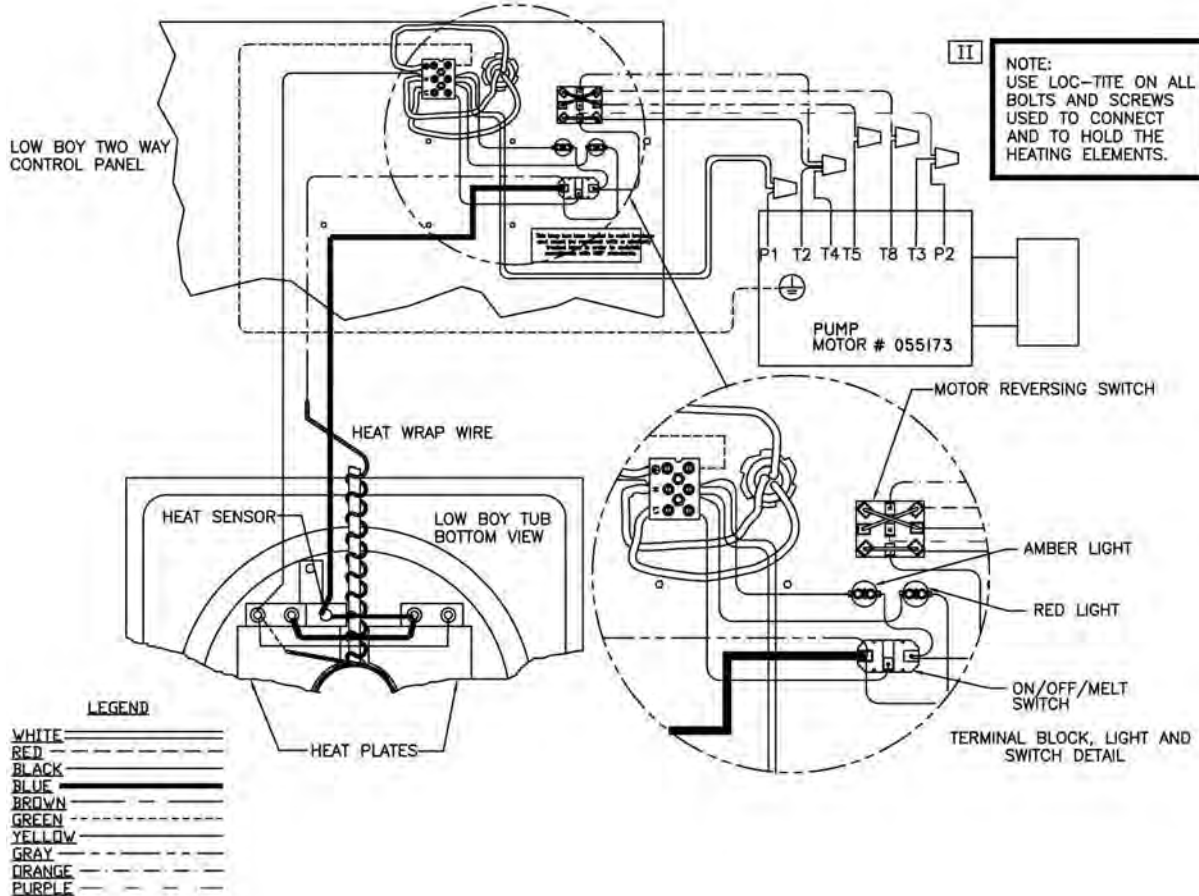

# LB165 & LB200 1 Way Pump (model 2004 series) - Pump Part # 055173

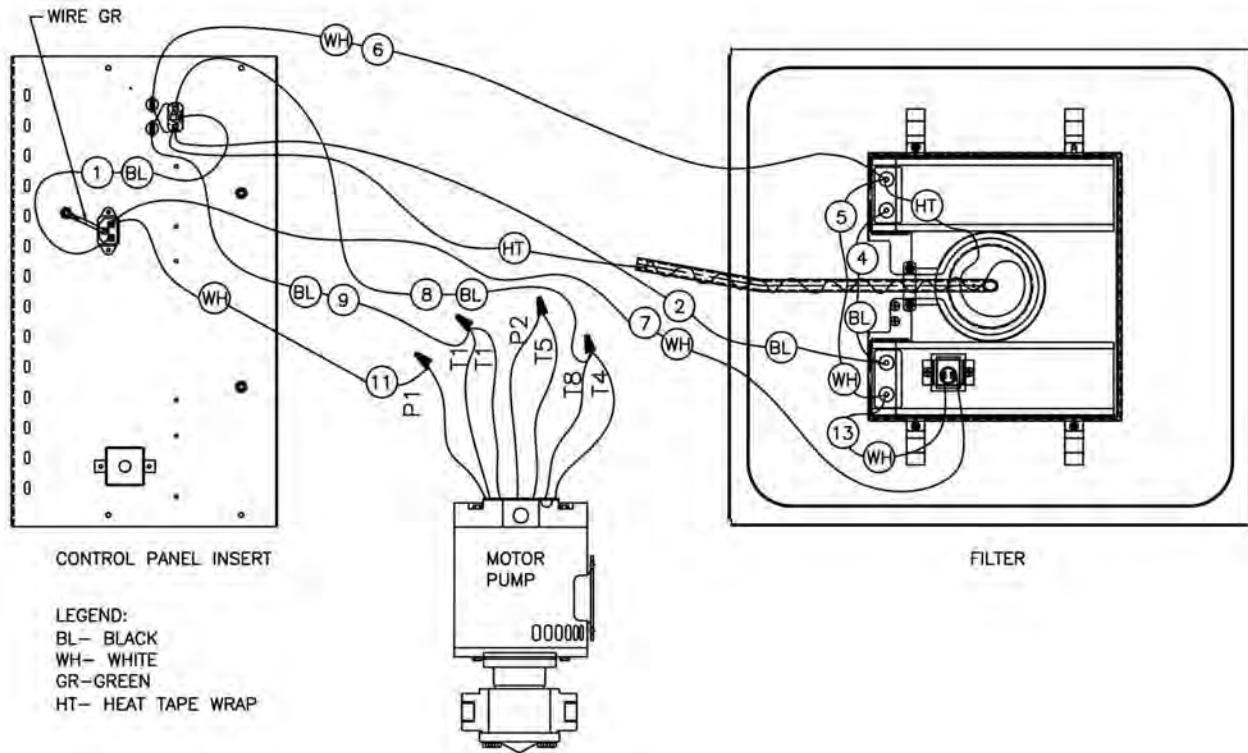

# LB165 & LB200 1 Way Pump (after 2005) - Pump Part # 055173

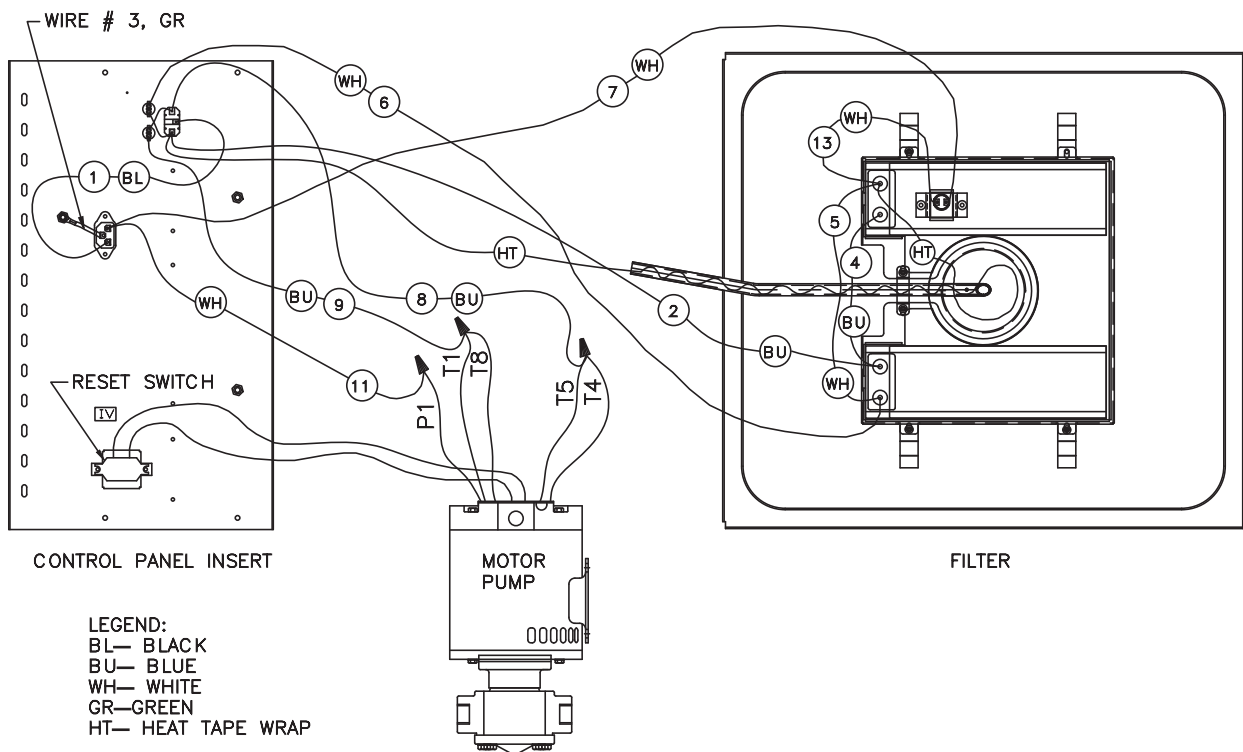

LB165 & LB200 1 Way Pump (model 2003 series) - Pump Part # 052982

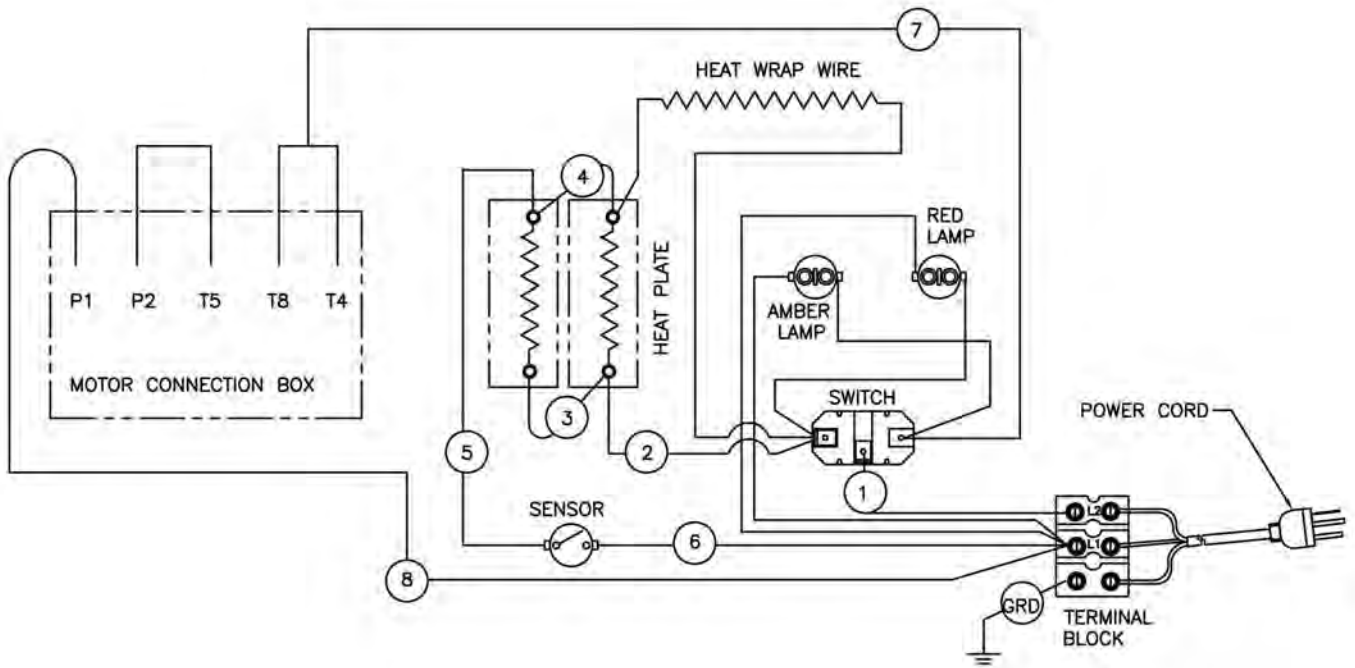

LB165 & LB200 2 Way Pump - Pump (after 2004) - Pump Part # 055173

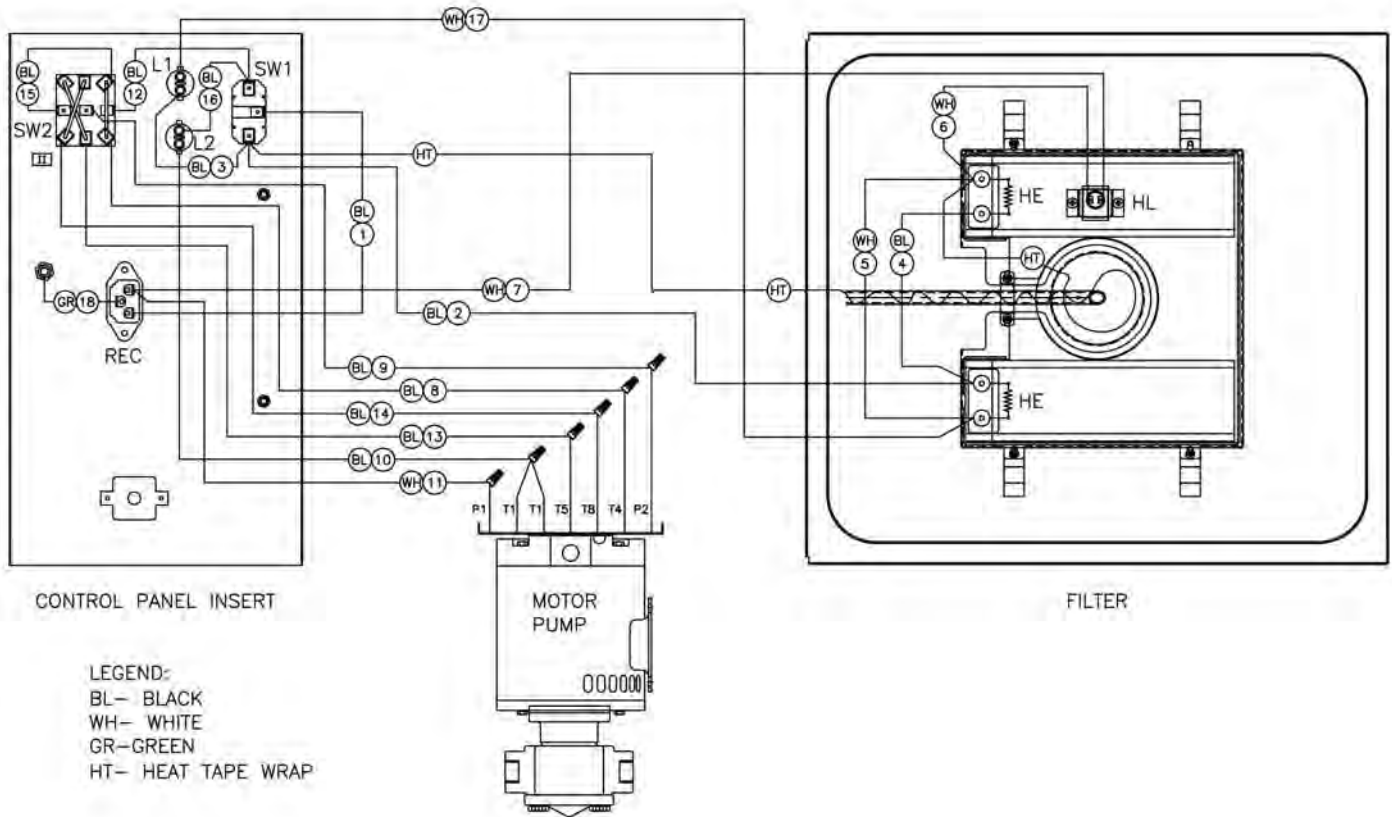

## LB200 1 Way Pump - Pump Part # 010567 (1993)

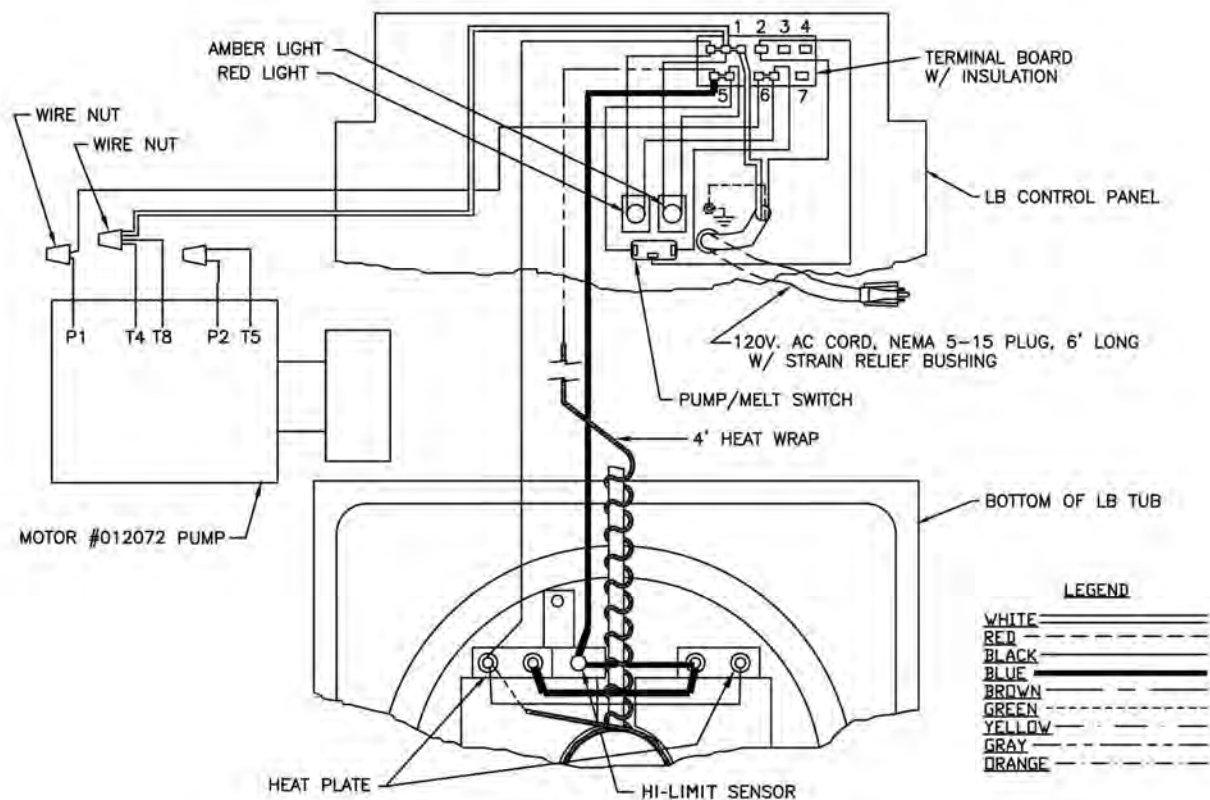

## LB200 2 Way Pump - Pump Part # 010567 (1993)

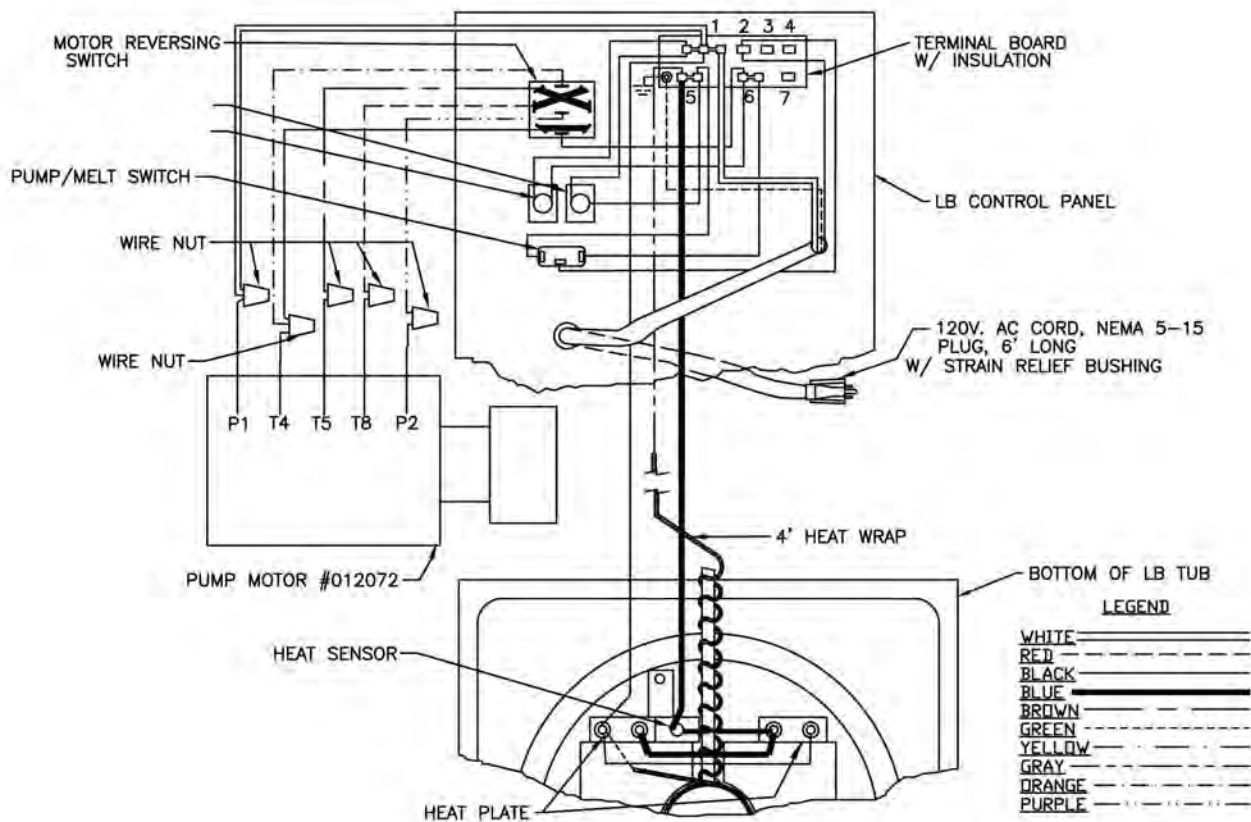

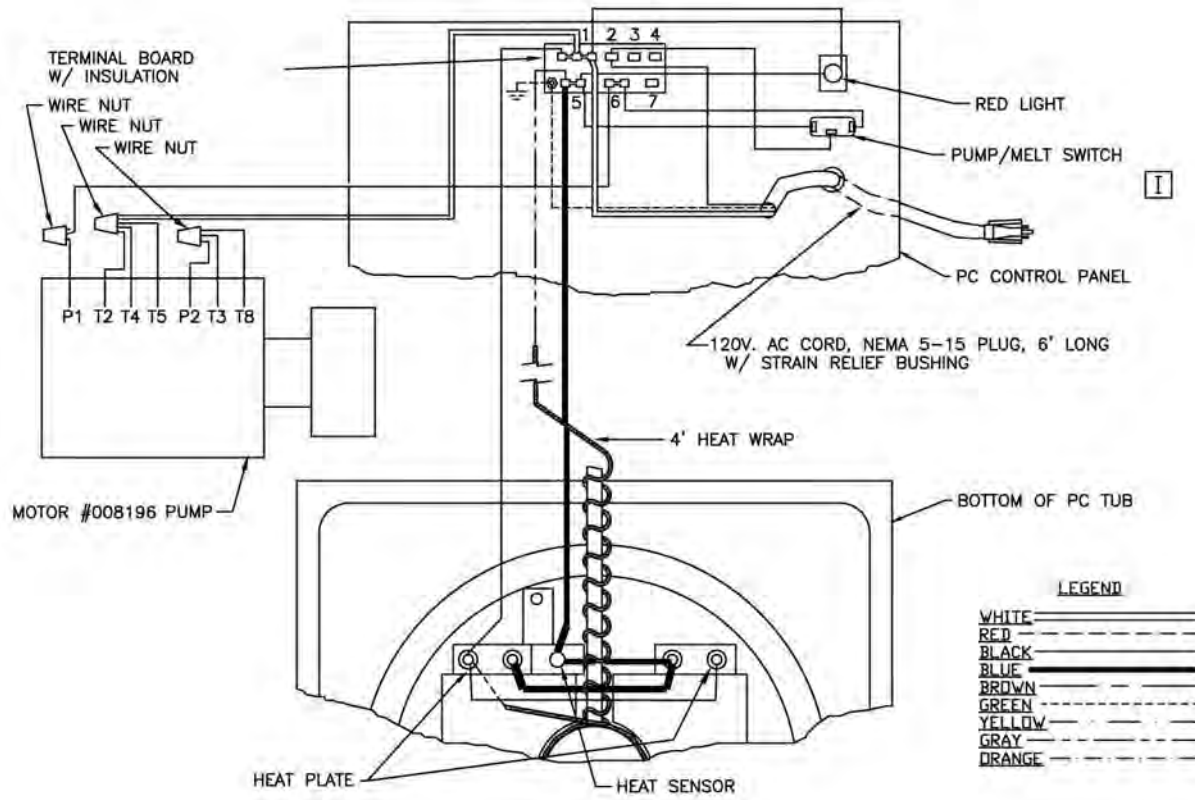



# WARRANTY

## LIMITED WARRANTY

Keating of Chicago, Inc. ("Keating") warrants to the original purchaser ("Customer"), all new Keating Fryers, Filter Systems, Griddles, Keep Krisp® Custom Pasta Systems, Top-Side™ Cookers, Computer Timers, Fryer & Pasta Vessels and Keating replacement parts ("products") installed after June 1, 1994 to be free to defects in material or workmanship, subject to the following terms and conditions.

## LENGTH OF WARRANTY

All products other than Fryer & Pasta Vessels and replacement parts shall be warranted for a period of one year from the date of original equipment installation. Keating replacement parts are warranted for a period of ninety days from the date of installation. Fryer & Pasta Vessels are warranted as described below.

## FRYER & PASTA VESSEL WARRANTY

Fryers purchased after June 1, 1994 carry a prorated vessel warranty on defects in materials or workmanship to the Customer based on the following scale:

Time from Installation Date	Fryer Vessel Warranty Credit
13-60 months	100%
61-72 months	80%
73-84 months	60%
85-96 months	40%
97-108 months	20%
109-120 months	10%

The credit for the defective fryer & pasta vessel shall be applied against the cost of the replacement vessel, utilizing Keating's then current price, upon return of the vessel to Keating, (freight to be paid by Keating within the first 2 months only), only during the first 60 months, subject to the limitations described below.

## LIMITATIONS OF LIABILITY

In the event of warranty claim or otherwise, the sole obligation of Keating shall be the repair and / or replacement at the option of Keating of the product or component or part thereof. Such repair or replacement shall be at the expense of Keating except that the Customer shall pay the following expenses: all freight and labor expense for Keating replacement parts; for all other products, mileage exceeding 50 miles or travel more than one hour, labor costs of more than one person, overtime rates, truck charges, difference between ground and other mode of transportation, and holiday charges. Any repair or replacement under this Limited Warranty does not constitute an extension of the original warranty for any period for the product or for any component or part thereof. Parts to be replaced under this Limited Warranty will be repaired at the option of Keating with new or functionally operative parts. Keep Krisps and Computer Timers must be returned to Keating for warranty repair or replacement. Field repairs of those items are not authorized.

THE LIABILITY OF KEATING ON ANY CLAIM OF ANY KIND, INCLUDING CLAIMS BASED ON WARRANTY, EXPRESSED OR IMPLIED, CONTRACT, NEGLIGENCE, STRICT LIABILITY OR ANY OTHER THEORIES SHALL BE SOLELY AND EXCLUSIVELY THE REPAIR OR REPLACEMENT OF THE PRODUCT AS STATED HEREIN, AND SUCH LIABILITY SHALL NOT INCLUDE, AND CUSTOMER SPECIFICALLY RENOUNCES ANY RIGHTS TO RECOVER, SPECIAL, INCIDENTAL, CONSEQUENTIAL OR OTHER INJURIES TO PERSONS OR DAMAGE TO PROPERTY, LOSS OF PROFITS OR ANTICIPATED PROFITS, OR LOSS OF USE OF THE PRODUCT.

If any oral statements have been made regarding the Keating products, such statements do not constitute warranties and are not part of the contract sale. This Limited Warranty constitutes the complete, final and exclusive statement with regard to warranties.

THIS LIMITED WARRANTY IS EXCLUSIVE AND IS IN LIEU OF ALL OTHER WARRANTIES WHETHER WRITTEN, ORAL, STATUTORY OR IMPLIED, INCLUDING BUT NOT LIMITED TO ANY WARRANTY OF MERCHANTABILITY OR FITNESS FOR PARTICULAR PURPOSE OR WARRANTY AGAINST LATENT DEFECTS.

## EXCLUSIONS

The warranties provided by Keating of Chicago, Inc. do not apply in the following instances:

1. Defects arising out of or resulting from improper installation or maintenance, abuse, misuse, modification or alteration by unauthorized service personnel, or any other condition not attributable to a defect in material or workmanship. Proper installation and maintenance are the responsibility of the installer and Customer, respectively. Proper installation and maintenance procedures are prescribed by the Keating Service Manual.
2. In the event that the product was damaged after leaving the factory due to flood, fire, other acts of God or accident, damage during shipment should be reported to the carrier and is not the responsibility of Keating.
3. In the event the serial number or rating plate has been removed from the product or altered.
4. On parts which would normally be worn or replaced under normal conditions, including but not limited to electric bulbs, fuses, interior and exterior finishes, gaskets and radiants.
5. With regard to adjustments and calibrations such as leveling, tightening of fasteners or plumbing connections, improper gas pressure or improper electrical supply, the checking of and changes in adjustment and calibrations are the responsibility of the installer. Proper installation procedures are prescribed by the Keating Service Manual.
6. In the event of unauthorized repairs or alterations to the Keating product.
7. With the use of sodium chloride in pasta vessels or harsh chemicals in fryer or pasta vessels.
8. Installation in Household.

## OTHER TERMS AND CONDITIONS

The Customer must provide proof of purchase from Keating.

This Limited Warranty is valid in the 50 United States, its territories, and Canada, and is void elsewhere.

Keating products are sold for commercial use only. If any Keating product is sold as a component of another product or used as a consumer product, such Keating product is sold As Is without any warranty. If any provision of this Limited Warranty is held to be unenforceable under the law of any jurisdiction, such provision shall be inapplicable in such jurisdiction, and the remainder of the warranty shall remain unaffected. Further in such event, the maximum exclusion or limitation allowable under applicable law shall be deemed substituted for the unenforceable provision.

This Limited Warranty shall be governed by and construed in accordance with the laws of the State of Illinois.

## TO SECURE WARRANTY SERVICE

All repair services under this Limited Warranty must be authorized by Keating or performed at Keating. Authorization may be obtained by calling 1-800-KEATING within the Continental United States, Alaska, Hawaii, Puerto Rico and Canada during normal business hours (8 a.m. through 5 p.m. Central Time, Monday through Friday). When calling, please have the following information available: (1) name, address and telephone number of the Customer; (2) location of product; if different; (3) name, model number and serial number of the product; (4) installation date; and (5) description of defect. Keating will then issue a service authorization work order number to one of its approved independent servicing organizations, or request the product or part be shipped to Keating for repair or replacement, as appropriate. Any defective part subject to a claim under this Limited Warranty must be shipped freight prepaid to Keating for testing and examination. Keating's decision as to the cause and nature of any defect under this Limited Warranty shall be final.

## SERVICE INFORMATION

If you have a service related question call 1-800-KEATING.  
Please state the nature of the call; it will ensure speaking with the appropriate person.  
Have your serial and model number available when ordering parts.

### KEATING OF CHICAGO, INC.

8901 West 50th Street, McCook, Illinois 60525-6001

Phone: (708) 246-3000 FAX: (708) 246-3100

Toll Free 1-800-KEATING (In U.S. and Canada)

www.keatingofchicago.com

**\*As continuous product improvement occurs, specifications may be changed without notice.**

---

### KEATING LIMITED WARRANTY CARD

PLEASE COMPLETE AND MAIL AT ONCE—WARRANTY IS NOT IN EFFECT UNTIL CARD IS RETURNED.  
WARRANTY CARD IS ALSO AVAILABLE TO COMPLETE ON LINE AT YOUR CONVENIENCE.

COMPANY: \_\_\_\_\_

ADDRESS: \_\_\_\_\_

CITY: \_\_\_\_\_ STATE: \_\_\_\_\_ ZIP: \_\_\_\_\_

DEALER: \_\_\_\_\_

DATE OF PURCHASE: \_\_\_\_\_ INVOICE NUMBER: \_\_\_\_\_

SERIAL NUMBER: \_\_\_\_\_  FRYER  FILTER SYSTEM  GRIDDLE

REMARKS: \_\_\_\_\_  TOP-SIDE COOKER  HOT PLATE  PASTA PLUS

I HAVE READ THE INSTALLATION AND OPERATION INSTRUCTIONS.

SIGNED: \_\_\_\_\_ DATE: \_\_\_\_\_

*"Serving Those Who Serve The Very Best"®*

portableFilter  
02/10



## Free Manuals Download Website

<http://myh66.com>

<http://usermanuals.us>

<http://www.somanuals.com>

<http://www.4manuals.cc>

<http://www.manual-lib.com>

<http://www.404manual.com>

<http://www.luxmanual.com>

<http://aubethermostatmanual.com>

Golf course search by state

<http://golfingnear.com>

Email search by domain

<http://emailbydomain.com>

Auto manuals search

<http://auto.somanuals.com>

TV manuals search

<http://tv.somanuals.com>