

Use & Care Guide

Manual de Uso y Cuidado

English / Español

Models/Modelos: 790.4422\*

# Kenmore®

## Electric Cooktop

## Parrilla de Cocinar Eléctrica

\* = Color number, número de color

P/N 318205603A (1010)

Sears Brands Management Corporation

Hoffman Estates, IL 60179 U.S.A.

[www.kenmore.com](http://www.kenmore.com)

[www.sears.com](http://www.sears.com)



---

## Table of Contents

Warranty .....	2	LED Messages or Light Indicators Displayed by	
IMPORTANT SAFETY INSTRUCTIONS .....	3-4	Cooking by Cooking Element Controls.....	8
Product Record.....	4	The available Window Displays Settings .....	8
Serial Plate Location .....	4	Hot Surface Indicators.....	8
Cooktop Features.....	5	Recommended Surface Cooking Settings .....	8
Surface Cookware.....	6	Locking the Controls .....	9
Selecting Surface Cooking Cookware.....	6	Single Radiant Element .....	9
Cookware Materials Types.....	6	Double Radiant Element.....	10
Using Woks .....	6	Bridge Radiant Elements .....	11
Setting Surface Controls.....	7-11	Warm & Hold Feature.....	11
General Cooktop Information.....	7	General Care & Cleaning .....	12-13
Using the Touch Control.....	8	Before You Call .....	14
Light Indicators Displayed by Main Control .....	8	Protection Agreements.....	15
		Sears Service.....	16

---

## Kenmore Warranty

When installed, operated and maintained according to all instructions supplied with the product, if this appliance fails due to a defect in material and workmanship within one year from the date of purchase, call 1-800-4-MY-HOME® to arrange for free repair.

This warranty applies for only 90 days from the date of purchase if this appliance is ever used for other than private family purposes.

**This warranty covers only defects in material and workmanship. Sears will NOT pay for:**

1. Cracks in a ceramic glass cooktop that are not a result of thermal shock.
2. Stains and scratches on a ceramic glass cooktop resulting from accident or improper operation or maintenance.
3. Expendable items that can wear out from normal use, including but not limited to filters, belts, light bulbs, and bags.
4. A service technician to instruct the user in correct product installation, operation or maintenance.
5. A service technician to clean or maintain this product.
6. Damage to or failure of this product if it is not installed, operated or maintained according to the all instructions supplied with the product.
7. Damage to or failure of this product resulting from accident, abuse, misuse or use for other than its intended purpose.
8. Damage to or failure of this product caused by the use of detergents, cleaners, chemicals or utensils other than those recommended in all instructions supplied with the product.
9. Damage to or failure of parts or systems resulting from unauthorized modifications made to this product.

### Disclaimer of implied warranties; limitation of remedies

Customer's sole and exclusive remedy under this limited warranty shall be product repair as provided herein. Implied warranties, including warranties of merchantability or fitness for a particular purpose, are limited to one year or the shortest period allowed by law. Sears shall not be liable for incidental or consequential damages. Some states and provinces do not allow the exclusion or limitation of incidental or consequential damages, or limitation on the duration of implied warranties of merchantability or fitness, so these exclusions or limitations may not apply to you.

This warranty applies only while this appliance is used in the United States or Canada.

This warranty gives you specific legal rights, and you may also have other rights which vary from state to state.

**Sears Brands Management Corporation, Hoffman Estates, IL 60179**  
**Sears Canada Inc., Toronto, Ontario, Canada M5B 2B8**

# IMPORTANT SAFETY INSTRUCTIONS

Read all instructions before using this appliance. Save these instructions for future reference. This manual contains important safety symbols and instructions. Please pay attention to these symbols and follow all instructions given.

**⚠ WARNING** This symbol will help alert you to situations that may cause serious bodily harm, death or property damage.

**⚠ CAUTION** This symbol will help alert you to situations that may cause bodily injury or property damage.

- **Remove all tape and packaging before using the appliance.** Destroy the carton and plastic bags after unpacking the appliance. Never allow children to play with packaging material. Do not remove the model/serial plate attached to the cooktop.
  - **Proper Installation. Be sure your appliance is properly installed and grounded by a qualified technician in accordance with National Electrical Code ANSI/NFPA No.70-latest edition and local code requirements.** Install only per installation instructions provided in the literature package for this appliance.
  - **In case of an emergency, know how to disconnect the electrical power to the appliance at the circuit breaker or fuse box.**
  - **User Servicing—Do not repair or replace any part of the appliance unless specifically recommended in the manuals.** All other servicing should be done only by a qualified technician to reduce the risk of personal injury and damage to the cooktop. Sears Parts & Repair is the recommended repair service for this appliance.
  - **Never modify or alter the construction of an appliance by removing panels, wire covers or any other part of the product.**
- ⚠ WARNING** Stepping or leaning on this cooktop can result in serious injuries and may also cause damage to the cooktop. Do not allow children to climb or play around the cooktop.
- **Storage on Appliance. Flammable materials should not be stored near surface units.** This includes paper, plastic and cloth items, such as cookbooks, plasticware and towels, as well as flammable liquids. Do not store explosives, such as aerosol cans, on or near the appliance. Flammable materials may explode and result in fire or property damage.

**⚠ WARNING** Do not store items of interest to children in the cabinets above the appliance.

- **Do not leave children alone. Children should not be left alone or unattended in the area where an appliance is in use.** They should never be allowed to sit or stand on any part of the appliance.

- **DO NOT TOUCH SURFACE UNITS OR AREAS NEAR THESE SURFACES.** Surface units may be hot even though they are dark in color. Areas near surface units may become hot enough to cause burns. During and after use, do not touch, or let clothing or other flammable materials touch these areas until they have had sufficient time to cool. Among these areas are the cooktop and areas facing the cooktop.
- **Wear Proper Apparel. Loose-fitting or hanging garments should never be worn while using the appliance.** Do not let clothing or other flammable materials contact hot surfaces.

**⚠ WARNING** Never use your appliance for warming or heating the room.

- **Do Not Use Water or Flour on Grease Fires.** Smother the fire with a pan lid, or use baking soda, a dry chemical or foam-type extinguisher.
- **When heating fat or grease, watch it closely.** Fat or grease may catch fire if allowed to become too hot.
- **Use Only Dry Potholders. Moist or damp potholders on hot surfaces may result in burns from steam.** Do not let the potholders touch hot heating surface units. Do not use a towel or other bulky cloth instead of a potholder.
- **Do Not Heat Unopened Food Containers.** Buildup of pressure may cause the container to burst and result in injury.

**IMPORTANT.** Do not attempt to operate the cooktop during a power failure. If the power fails, always turn off the cooktop. If the cooktop is not turned off and the power resumes, the cooktop will begin to operate again. Food left unattended could catch fire or spoil.

## IMPORTANT INSTRUCTIONS FOR USING YOUR COOKTOP

- **Know which touch pad controls each surface unit.**
- **Clean the appliance regularly to keep all parts free of grease that could catch fire.** Exhaust fan ventilation hoods and grease filters should be kept clean. Do not allow grease to accumulate on hood or filter. Greasy deposits in the fan could catch fire. When flaming food under the hood, turn fan on. Refer to hood manufacturer's instructions for cleaning.

# IMPORTANT SAFETY INSTRUCTIONS

**⚠ WARNING Use Proper Pan Size.** This appliance is equipped with one or more surface units of different sizes. Select utensils having flat bottoms large enough to cover the surface unit. The use of undersized utensils will expose a portion of the surface heating unit to direct contact and may result in ignition of clothing. Proper relationship of utensil to the surface unit will also improve efficiency.

- **Utensil Handles Should Be Turned Inward from Edges of Cooktop and Should Not Extend Over Adjacent Surface Units.** To reduce the risk of burns, ignition of flammable materials, and spillage due to unintentional contact with the utensil.
- **Never Leave Surface Units Unattended at a Hi Heat Settings.** Boilovers cause smoking and greasy spillovers that may ignite, or a pan that has boiled dry may melt.
- **Protective Liners.** Do not use aluminum foil to line any part of the appliance. Only use aluminum foil as recommended for baking if used as a cover placed on the food. Any other use of protective liners or aluminum foil may result in a risk of electric shock or fire or short circuit.
- **Glazed Cooking Utensils.** Only certain types of glass, glass/ceramic, ceramic, earthenware, or other glazed utensils are suitable for range top service without breaking due to the sudden change in temperature. Check the manufacturer's recommendations for cooktop use.
- **Ventilating hood.** The ventilating hood above your cooking surface should be cleaned frequently, so the grease from cooking vapors does not accumulate on the hood or filter.

- **Do Not Use Decorative Surface Element Covers.** If an element is accidentally turned on, the decorative cover will become hot and possibly melt. Burns will occur if the hot covers are touched. Damage may also be done to the appliance.
- **Do Not Clean or Operate a Broken Cooktop.** If cooktop should break, cleaning solutions and spillovers may penetrate the broken cooktop and create a risk of electric shock. Contact a qualified technician immediately.
- **Clean Cooktop with Caution.** If a wet sponge or cloth is used to wipe spills on a hot cooking area, be careful to avoid a steam burn. Some cleaners can produce harmful fumes if applied to a hot surface.
- **Do Not Place Hot Cookware on Cold Cooktop Glass.** This could cause glass to break.
- **Do not slide pans across the cooktop surface.** They may scratch the cooktop surface.
- **Do not let pans boil dry.** Pans that boil dry may permanently damage the cooktop by breaking, fusing to, or marking it. (This type of damage is not covered by your warranty).

---

## IMPORTANT SAFETY NOTICE

The California Safe Drinking Water and Toxic Enforcement Act requires the Governor of California to publish a list of substances known to the state to cause cancer, birth defects or other productive harm, and requires businesses to warn customers of potential exposure to such substances.

---

## Product Record

In this space below, record the date of purchase, model and serial number of your product. You will find the model and serial number printed on the serial plate. This serial plate is located under the cooktop. **See bottom** of this page for the serial plate location.

Model No. \_\_\_\_\_

Serial No. \_\_\_\_\_

Date of purchase \_\_\_\_\_

Save these instructions and your sales receipt for future reference.

## Serial Plate Location

You will find the model and serial number printed on the serial plate. The serial plate is located under the cooktop.

Please see the illustration for exact location. Remember to record the serial number for future reference (See Product Record above).

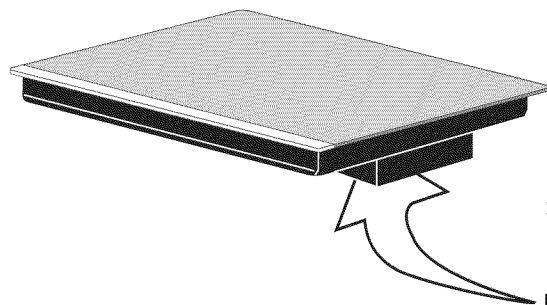

Serial plate  
is located  
under the  
burner box.

# Cooktop Features

READ THESE INSTRUCTIONS CAREFULLY BEFORE USING THE COOKTOP

**CAUTION** The Cooking Zones may appear to be cool while turned ON and after they have been turned OFF. The glass surface may be **HOT** from residual heat transferred from the cookware and burns may occur.

1. Left Rear Single Radiant Element
2. Center Left Bridge Radiant Element
3. Left Front Bridge Radiant Element
- 4A. Center Rear Single Radiant Element
4. Right Rear Single Radiant Element
5. Right Front Double Radiant Element
6. Right Rear Single Element Control Pads
- 6A. Center Rear Single Element Control Pads
7. Left Rear Single Element Control Pads
8. Left Front & Bridge Element Control Pads
9. Right Front Double Element Control Pads
10. Main Cooktop Controls

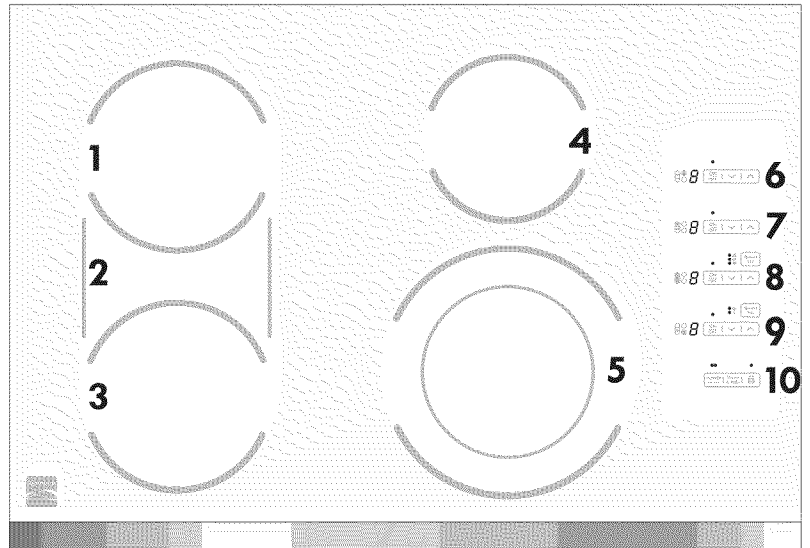

Fig. 1 - 30" Model

11. Cooktop Power Indicator Light
12. Controls Lockout Indicator Light
13. Cooktop Power Key Pad
14. Warm & Hold Setting Key Pad
15. Controls Lock Key Pad

16. Element On/Off Indicator Light (One for each element)
17. Element Power Level Display (One for each element)
18. Element On/Off Key Pad (One for each element)
19. Decrease Power Key pads (for each element)
20. Increase Power Key pads (for each element)
21. Element Size Indicator Lights (Double & Bridge elements only)
22. Element Size Key Pad (Double & Bridge elements only)

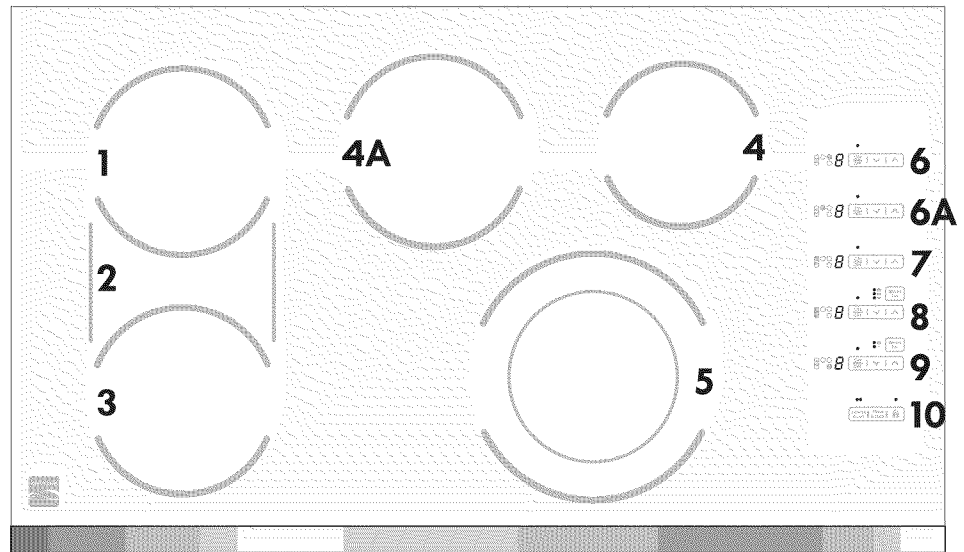

Fig. 2 - 36" Model



**13** **14** **15**  
10 Main Cooktop Controls



**16**



**17** **18** **19** **20**  
6 6A & 7 Single Element Controls  
(at 2 or 3 locations)



**16**



**21**



**22**  
Element Size



**17** **18** **19** **20**  
9 Double Element Controls  
(at 1 location)



**16**



**21**



**22**  
Element Size

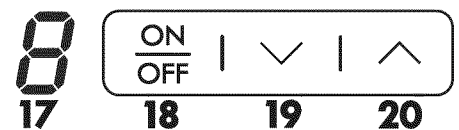

**17** **18** **19** **20**  
8 Bridge Element Control  
(at 1 location)

# Surface Cookware

## Selecting Surface Cooking Cookware

Cookware should have flat bottoms that make good contact with the entire surface heating element. Check for flatness by rotating a ruler across the bottom of the cookware (See Figure 1). Be sure to follow the recommendations for using cookware as shown in Figure 2.

Figure 1). Be sure to follow the recommendations for using cookware as shown in Figure 2.

**Note:** The size and type of cookware used will influence the setting needed for best cooking results.

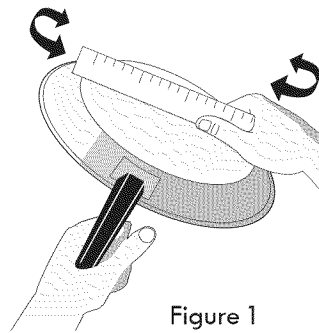
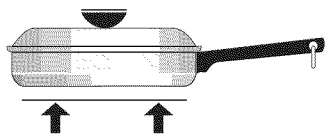

Figure 1

### Correct



- Flat bottom and straight sides.
- Tight fitting lids.
- Weight of handle does not tilt pan. Pan is well balanced.
- Pan sizes match the amount of food to be prepared and the size of the surface element.
- Made of a material that conducts heat well.
- Easy to clean.
- Always match pot diameter to element surface diameter.

### Incorrect

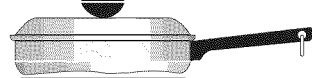

- Curved and warped pan bottoms.

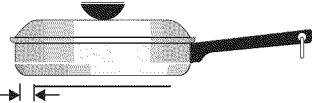

- Pan overhangs element by more than one-half inch.

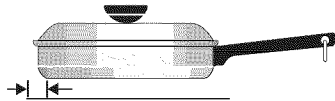

- Pan is smaller than element.



- Heavy handle tilts pan.

Figure 2

## Cookware Material types

The cookware material determines how evenly and quickly heat is transferred from the surface element to the pan bottom. The most popular materials available are:

**ALUMINUM** - Excellent heat conductor. Some types of food will cause it to darken (Anodized aluminum cookware resists staining & pitting). If aluminum pans slide across the ceramic glass cooktop, they may leave metal marks which will resemble scratches. Remove these marks immediately.

**COPPER** - Excellent heat conductor but discolors easily. May leave metal marks on ceramic glass (see Aluminum above).

**STAINLESS STEEL** - Slow heat conductor with uneven cooking results. Is durable, easy to clean and resists staining.

**CAST IRON** - A poor heat conductor however will retain heat very well. Cooks evenly once cooking temperature is reached. Not recommended for use on ceramic cooktops.

**PORCELAIN-ENAMEL on METAL** - Heating characteristics will vary depending on base material. Porcelain-enamel coating must be smooth to avoid scratching ceramic cooktops.

**GLASS** - Slow heat conductor. Not recommended for ceramic cooktop surfaces because it may scratch the glass.

### Important note:

**Do not place empty** aluminum, glass or porcelain-enamel coated cookware on the ceramic cooktop! The melting point of cookware made with these materials may be reached quickly especially if left empty & they may bond to the ceramic cooktop. If the cookware melts it will damage the cooktop! Be sure to follow all the cookware manufacturer's suggestions when using any type of cookware on the ceramic cooktop.

## Using Woks

For ceramic glass cooktop models, use only flat bottomed woks (without support rings).

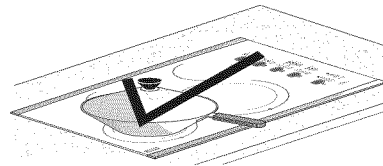

**CAUTION** DO NOT use a wok if it is equipped with a metal ring that extends beyond the surface element. Because this ring traps heat, the surface element and cooktop surface could be damaged.

**Wire trivets:** Do not use wire trivets. Cookware bottoms must be in direct contact with the surface cooking areas.

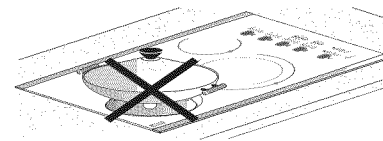

**CAUTION** DO NOT use two surface cooking areas, if your appliance is not equipped with a bridge element, to heat one large pan such as a roaster or griddle. DO NOT allow cooking utensils to boil dry. Either of these situations could damage the glass ceramic cooktop.

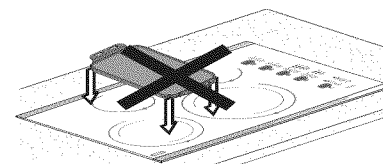
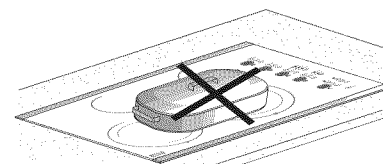

# Setting Surface Controls

## General Cooktop Information

### About the Ceramic Glass Cooktop

The ceramic cooktop has radiant surface elements located below the surface of the glass. The design of the ceramic cooktop outlines the area of the surface element underneath. **Make sure** the diameter of the pan matches the diameter of the element outline on the cooktop.

Heat is transferred up through the surface of the cooktop to the cookware. Only flat-bottom cookware should be used. The type and size of cookware, the number of surface elements in use and their settings, are all factors that will affect the amount of heat that will spread to areas beyond the surface elements. The areas surrounding the elements may become **hot enough to cause burns**.

### About the Radiant Surface Elements

The element temperature rises gradually and evenly. As the temperature rises, the element will glow red. To maintain the selected setting, the element will cycle on and off. The heating element retains enough heat to provide a uniform and consistent heat during the off cycle. For energy efficient cooking, turn off the element several minutes before cooking is complete. This will allow residual heat to complete the cooking process.

### Locations of the Radiant Surface Elements and Controls

Your cooktop is equipped with radiant surface elements with different wattage ratings. The ability to heat food quicker and in larger volumes increases as the element wattage increases.

The radiant surface elements are located on the 30" cooktop as follows (See Fig. 1):

- One small **6 inch** radiant element located at the right rear position.
- One **double 9 inch** radiant element located at the right front position.
- One **7 inch** radiant element located at the left rear position.
- One **Bridge** radiant element located on the left side.

The radiant surface elements are located on the 36" cooktop as follows (See Fig. 2):

- One small **6 inch** radiant element located at the right rear position.
- One **double 9 inch** radiant element located at the right front position.
- Two **7 inch** radiant elements located at the left and center rear positions.
- One **Bridge** radiant element located on the left side.

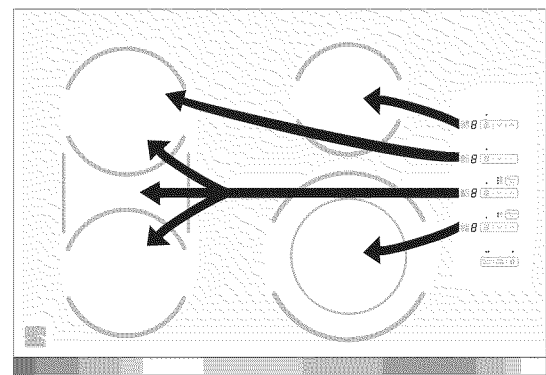

30" Cooktop - Location of the Radiant Surface Elements and Controls  
Fig. 1

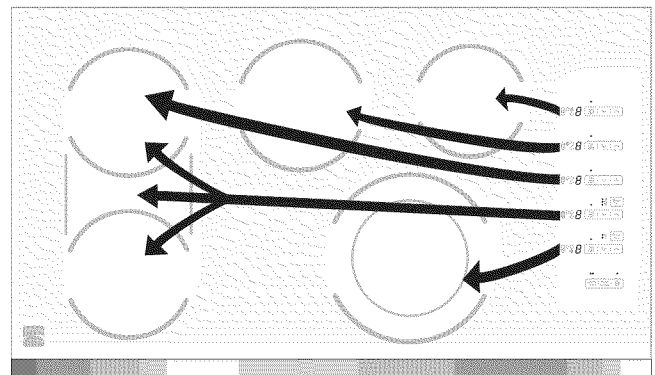

36" Cooktop - Location of the Radiant Surface Elements and Controls  
Fig. 2

**NOTE:** Please read detailed instructions for ceramic glass cooktop cleaning in the **General Care & Cleaning** section and **Before You Call** checklist section of this Use and Care Guide.

**NOTE:** Radiant elements have a limiter that allows the element to cycle on and off to maintain consistent heat even at the HI setting. This helps to prevent damage to the ceramic cooktop. Cycling is normal and will occur even more often if the cookware is too small for the radiant element or if the cookware bottom is not flat (For information concerning cookware, refer to **Use Proper Cookware** on page 6 of this Use and Care Guide).

**NOTE:** (White glass cooktops only). Due to the high intensity of heat generated by the surface elements, the glass surface will turn green when the element is turned off. This phenomenon is normal and the glass will come back to its original white color after it has completely cooled down.



# Setting Surface Controls

## Using the Touch Control

Be sure that your finger is placed in the center of the touch pad. If the finger is not placed on the center of a pad, the cooktop may not respond to the selection made.

Lightly contact the pad with the flat part of your entire fingertip. Do not just use the narrow end of your fingertip.

## Light Indicators Displayed by Main Control



**CONTROLS LOCK-** This feature allows the cooktop to be locked when no cooking zones are active. If the cooktop is in use, it will not be possible to lock the controls. Touch and hold the  key pad for few seconds. A beep will sound and the Lock indicator light will glow (Fig. 2). Once locked no Cooking Zones will activate. To turn the Controls Lock OFF, touch and hold the  key pad for few seconds. A beep will sound, the Lock indicator light will turn OFF (Fig. 1) and the cooktop may be used normally.

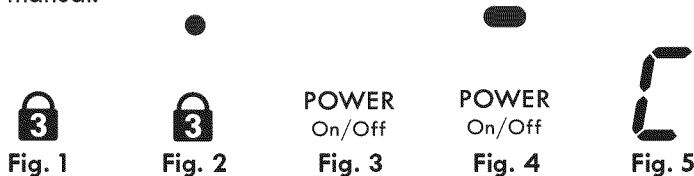

**COOKTOP POWER-** The Cooktop POWER key pad activates the entire Cooktop. To power the cooktop, touch and hold the POWER key pad. A beep will sound and the Power LED will glow (See Fig. 4). The cooktop will be in a ready mode. If no other key pads are touched the Cooktop Main POWER will turn OFF automatically. To turn the Main Power OFF touch and hold the Main POWER key pad. A beep will sound and the Power Indicator Light will turn OFF (See Fig. 3).

**ERROR CODES X -** The element power level displays can show error codes. When this happens, single zone display "C" (Fig. 5) followed by the error code number. Error code can also be shown steadily in the 4 zones displays. If this happens, please refer to section "Before you call" in this manual.



## LED Messages or Light Indicators Displayed by Cooking Element Controls

**COOKING ZONE ON/OFF PAD -** Each Cooking Element has separate ON/OFF key pads. Once the Main Power key pad has been touched to activate the cooktop, touch the corresponding Cooking Element ON/OFF key pad once to activate the Cooking Zone needed. "0" will appear in the LED display. If the corresponding  (increase) /  (decrease) key pad is not touched, the request to turn the Cooking Element ON will cancel and the Cooktop Main Power will turn OFF. To set a Cooking Element power level

touch the corresponding Cooking Element  (increase) or  (decrease) key pad once. To turn OFF a Cooking Element, touch the Cooking Element ON/OFF key pad once. The Cooking Element Indicator Light will turn OFF.

## The available Window Display Settings

The control will display heat levels ranging from 9 indicating the higher level (Fig. 6) to 1 indicating the lower level (Fig. 7) and OFF (Fig. 9). The settings between 1 (Fig. 7) and 7 (Fig. 8) decrease or increase in increments of .5 for more precise settings at lower heat levels (example 3.5; Fig. 10). The settings between 7 (Fig. 8) and 9 (Fig. 6) decrease or increase in increments of 1. Use the Recommended Surface Setting Chart to determine the correct setting for the kind of food you are preparing.

## Hot Surface Indicators

After using any of the radiant element positions the cooktop will become very hot. After turning any of these elements OFF, the cooktop will remain HOT for some time. "H" (hot element) will appear in the element power level display while the element is still hot. The H indicator will remain in the display until the element has cooled sufficiently (See Fig. 11).

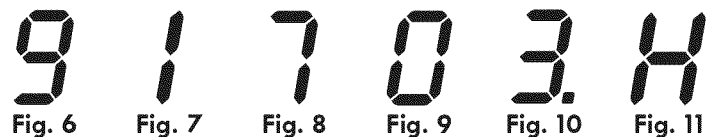

## Recommended Surface Cooking Settings

The suggested power level settings are based on cooking with medium sized aluminum pans with lids. Be sure to make any further setting adjustments for best surface cooking results.

Recommended Settings for Single, Bridge & Double Surface Elements	
Setting	Type of Cooking
HIGH (8 - 9)	Start most foods, bring water to a boil or pan broiling.
MEDIUM HIGH (5 - 7)	Continue a rapid boil, fry, deep fat fry.
MEDIUM (5)	Maintain a slow boil, thicken sauces and gravies, steam vegetables.
MEDIUM LOW (2 - 4)	Keep foods cooking, poach, stew.
LOW (1 - 2)	Keep warm, melt, simmer.

**Note:** The size and type of cookware used will influence the setting needed for best cooking results. The Simmer settings are used to simmer and keep larger quantities of foods warm such as stews and soups. The lower Simmer settings are ideal for delicate foods and melting chocolate or butter.



# Setting Surface Controls

## Locking the controls

The Cooktop Controls can be locked in order to prevent the cooktop from accidentally being turned ON. This feature can be activated only when no cooking zone is active. If the cooktop is in use, it will not be possible to lock the controls.

### To Turn ON the Controls Lock Feature:

Touch and hold the **3** key pad. After a few seconds a beep will sound. The Lock Indicator Light above the **3** key pad will turn ON indicating the cooktop is locked. This will keep any Cooking Element or Cooktop functions from being accidentally turned ON. **Note:** If the cooktop is in use when the Control Lock Feature is activated, the command will be ignored.

### To Turn OFF the Controls Lock Feature:

Touch and hold the **3** key pad. After a few seconds a beep will sound. The Lock Indicator Light above the **3** key pad will turn OFF indicating the cooktop is unlocked. The Cooking Elements or any of the other Cooktop functions may now be used.

## Single Radiant Element

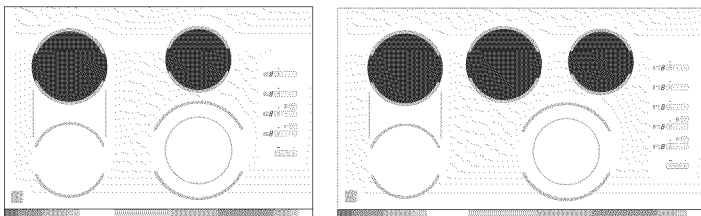

The cooktop provides single radiant element located as illustrated. Use the following instructions when operating these elements.

### To Operate the Single Radiant Surface Elements:

1. Place correctly sized cookware on the radiant surface element.
2. Touch and hold the **POWER** On/Off pad until a beep sounds. The power indicator light will turn ON. **Note:** If no key pad is touched within 10 seconds the request to Power ON the cooktop will clear.
3. Touch and hold **ON** OFF pad for the desired element position until a beep is heard. The element display will show "0". **Note:** If no further pads are touched within 10 seconds the request to power the element ON will clear.
4. Touch **^** pad once to turn ON the power level to **9** (Hi). Touch **v** pad once for **1** (Lo).

5. Each touch of the **^** or **v** pad will increase or decrease the power level from **1** through **9**. Half power levels (available between 1 and 7 power level) are indicated by lighting the display decimal point. **Note:** The power level may be adjusted at any time while the element is ON.
6. When cooking has been completed touch the **ON** OFF pad once to turn the element OFF and if no other surface element is used touch the **POWER** On/Off key pad to turn off the cooktop. **Note:** The **H** (hot element) message will remain ON if the cooktop is still hot and will remain ON until the heating surface area has cooled sufficiently.

### Hot Element Indicator Message

After using any of the radiant element positions the cooktop will become very hot. Even after setting the controls to OFF, the cooktop will remain hot for some time. The cooktop control monitors the temperature of the cooktop and element display shows the message "H" (hot element) warning when the cooktop is still too hot to touch. If the **H** message appears in the element window, the control can still be turned on again for use.

**CAUTION** Radiant surface elements may appear to have cooled after they have been turned off. **The glass surface may still be hot** and burns may occur if the glass surface is touched before it has cooled sufficiently.

**CAUTION** Do not place aluminum foil, plastic items such as salt and pepper shakers, spoon holders or plastic wrappings on top of the range when it is in use. These items could melt or ignite. Potholders, towels or wooden spoons could catch fire if placed too close to the surface elements.

### Important notes:

- Start most cooking operations on a higher setting and then turn to a lower setting to finish cooking.
- For efficient cooking, turn the surface element OFF several minutes before cooking is complete. This will allow residual heat to complete the cooking process.
- A glowing red surface heating area extending beyond the bottom edge of the cookware indicates the cookware is **too small** for the surface heating area.
- Radiant elements have a limiter that allows the radiant heating element to cycle ON and OFF, even at the **9** (hi) setting. This helps prevent damage to the ceramic cooktop. Cycling at the **9** (HI) setting is normal and will occur more often if the cookware is too small for the radiant element or if the cookware bottom is not flat.

# Setting Surface Controls

## Double Radiant Element

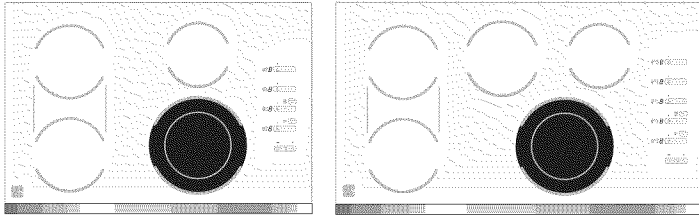

The cooktop provides a double radiant element located as illustrated. Use the following instructions when operating these elements.

Use the **ELEMENT SIZE** keypad (Fig. 1) to select which portions of the expandable element are needed for heating. The double element size may be changed anytime the element is ON.

### To Operate the Double Radiant Element:





1. Place correctly sized cookware on the radiant surface element.
2. Touch and hold the <sup>POWER</sup> <sub>On/Off</sub> pad until a beep sounds. The power indicator light will turn ON. **Note:** If no key pad is touched within 10 seconds the request to Power ON the cooktop will clear.
3. Touch and hold <sup>ON</sup> <sub>OFF</sub> pad for the double element until a beep is heard. The element display will show "0". **Note:** If no further pads are touched within 10 seconds the request to power the element ON will clear.
4. Press **ELEMENT SIZE** keypad and toggle to select the single (Fig. 2) or double (Fig. 3) expandable element size setting.
5. Touch  pad once to turn ON the power level to **9** (Hi). Touch  pad once for **1** (Lo).
6. Each touch of the  or  pad will increase or decrease the power level from **1** through **9**. Half power levels (available between 1 and 7 power level) are indicated by lighting the display decimal point. **Note:** The power level may be adjusted at any time while the element is ON.
7. When cooking has been completed touch the <sup>ON</sup> <sub>OFF</sub> pad once to turn the element OFF and if no other surface element is used touch the <sup>POWER</sup> <sub>On/Off</sub> key pad to turn off the cooktop. **Note:** The **H** (hot element) message will remain ON if the cooktop is still hot and will remain ON until the heating surface area has cooled sufficiently.



Fig. 1

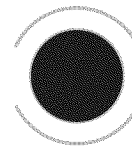

Fig. 2

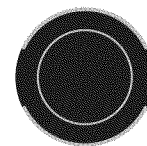

Fig. 3

### Hot Element Indicator Message

After using any of the radiant element positions the cooktop will become very hot. Even after setting the controls to OFF, the cooktop will remain hot for some time. The cooktop control monitors the temperature of the cooktop and displays the message "H" (hot element) warning when the cooktop is still too hot to touch. If the **H** message appears in the window, the control can still be turned on again for use.

**CAUTION** Radiant surface elements may appear to have cooled after they have been turned off. **The glass surface may still be hot** and burns may occur if the glass surface is touched before it has cooled sufficiently.

**CAUTION** Do not place aluminum foil, plastic items such as salt and pepper shakers, spoon holders or plastic wrappings on top of the range when it is in use. These items could melt or ignite. Potholders, towels or wooden spoons could catch fire if placed too close to the surface elements.

### Important notes:

- If no element size is chosen when the expandable element is turned ON, only the inner coil will heat by default.
- Start most cooking operations on a higher setting and then turn to a lower setting to finish cooking.
- For efficient cooking, turn the surface element OFF several minutes before cooking is complete. This will allow residual heat to complete the cooking process.
- A glowing red surface heating area extending beyond the bottom edge of the cookware indicates the cookware is **too small** for the surface heating area.
- Radiant elements have a limiter that allows the radiant heating element to cycle ON and OFF, even at the **9** (hi) setting. This helps prevent damage to the ceramic cooktop. Cycling at the **9** (HI) setting is normal and will occur more often if the cookware is too small for the radiant element or if the cookware bottom is not flat.

# Setting Surface Controls

## Bridge Radiant Element

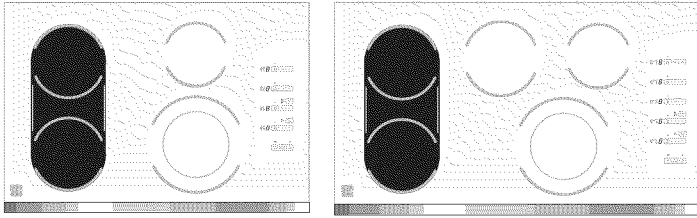

The cooktop provides a bridge radiant element located as illustrated. Use the following instructions when operating these elements.

Use the **ELEMENT SIZE** keypad (Fig. 1) to select which portions of the bridge element are needed for heating. The element size may be changed anytime the element is ON.

### To Operate the Bridge Radiant Element:

1. Place correctly sized cookware on the radiant surface element.
2. Touch and hold the <sup>POWER</sup> <sub>On/Off</sub> pad until a beep sounds. The power indicator light will turn ON. **Note:** If no key pad is touched within 10 seconds the request to Power ON the cooktop will clear.
3. Touch and hold <sup>ON</sup> <sub>OFF</sub> pad for the bridge element until a beep is heard. The element display will show "0". **Note:** If no further pads are touched within 10 seconds the request to power the element ON will clear.
4. Press **ELEMENT SIZE** keypad and toggle to select the front portion (Fig. 2), the front and center portion (Fig. 3) or the entire (Fig. 4) bridge element.
5. Touch pad once to turn ON the power level to 9 (Hi). Touch pad once for 1 (Lo).
6. Each touch of the or pad will increase or decrease the power level from 1 through 9. Half power levels (available between 1 and 7 power level) are indicated by lighting the display decimal point. **Note:** The power level may be adjusted at any time while the element is ON.
7. When cooking has been completed touch the <sup>ON</sup> <sub>OFF</sub> pad once to turn the element OFF and if no other surface element is used touch the <sup>POWER</sup> <sub>On/Off</sub> key pad to turn off the cooktop. **Note:** The **H** (hot element) message will remain ON if the cooktop is still hot and will remain ON until the heating surface area has cooled sufficiently.

### Hot Element Indicator Message

After using any of the radiant element positions the cooktop will become very hot. Even after setting the controls to OFF, the cooktop will remain hot for some time. The cooktop control monitors the temperature of the cooktop and displays the message "H" (hot element) warning when the cooktop is still too hot to touch. If the **H** message appears in the window, the control can still be turned on again for use.



Fig. 1



Fig. 2

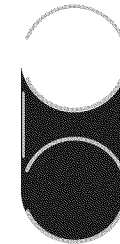

Fig. 3

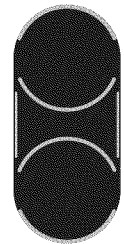

Fig. 4

**CAUTION** Radiant surface elements may appear to have cooled after they have been turned off. **The glass surface may still be hot** and burns may occur if the glass surface is touched before it has cooled sufficiently.

**CAUTION** Do not place aluminum foil, plastic items such as salt and pepper shakers, spoon holders or plastic wrappings on top of the range when it is in use. These items could melt or ignite. Potholders, towels or wooden spoons could catch fire if placed too close to the surface elements.

### Important notes:

- If no element size is chosen when the bridge element is turned ON, only the front coil will heat by default.
- Start most cooking operations on a higher setting and then turn to a lower setting to finish cooking.
- For efficient cooking, turn the surface element OFF several minutes before cooking is complete. This will allow residual heat to complete the cooking process.
- A glowing red surface heating area extending beyond the bottom edge of the cookware indicates the cookware is **too small** for the surface heating area.
- Radiant elements have a limiter that allows the radiant heating element to cycle ON and OFF, even at the 9 (hi) setting. This helps prevent damage to the ceramic cooktop. Cycling at the 9 (HI) setting is normal and will occur more often if the cookware is too small for the radiant element or if the cookware bottom is not flat.

### Warm & Hold Feature

The Warm & Hold feature may be used with any of the Cooking Elements.

#### To Turn the Warm & Hold Feature ON:

1. To select the Warm & Hold feature for any Cooking Element touch the <sup>ON</sup> <sub>OFF</sub> key pad for the corresponding Cooking Element.  
<sub>Warm</sub>
2. Touch the key pad located in the main control area. The associated display will show **L** (low heat) indicating that the Cooking Element is properly set to Warm & Hold. If no other key pads are pressed the control will activate the desired Cooking Element at the Warm & Hold setting.

# General Care & Cleaning

## Cleaning Various Parts of Your Cooktop

Before cleaning any part of the cooktop, be sure all controls are turned OFF and the cooktop is COOL. REMOVE SPILLOVERS AND HEAVY SOILING AS SOON AS POSSIBLE. REGULAR CLEANINGS NOW WILL REDUCE THE DIFFICULTY AND EXTENT OF A MAJOR CLEANING LATER.

Surfaces	How to Clean
<b>Aluminum</b> (Trim Pieces)	Use hot, soapy water and a cloth or paper towel. Dry with a clean cloth.
<b>Painted and Plastic</b> Control Knobs, Body Parts, and Decorative Trim	For general cleaning, use hot soapy water and a cloth. For more difficult soils and built-up grease, apply a liquid detergent directly onto the soil. Leave on soil for 30 to 60 minutes. Rinse with a damp cloth and dry. <b>DO NOT</b> use abrasive cleaners on any of these materials; they can scratch or dull the finish.
<b>Stainless Steel, Chrome parts</b> Decorative Trim Cooktop	Clean with hot, soapy water and a dishcloth. Rinse with clean water and cloth. <b>Do not use cleaners with high concentrations of chlorides or chlorines.</b> Do not use harsh scrubbing cleaners. Only use kitchen cleaners that are especially made for cleaning stainless steel. Always be sure to rinse the cleaners off from the surface as bluish stains may occur during heating that cannot be removed.
<b>Ceramic Glass Cooktop</b>	See <b>Ceramic Glass Cooktop Cleaning &amp; Maintenance</b> in this Use & Care Guide.

## Ceramic Glass Cooktop Cleaning & Maintenance

**Consistent and proper cleaning is essential to maintaining your Ceramic glass cooktop**

Prior to using your cooktop for the first time, apply the recommended CookTop® Cleaning Creme to the ceramic surface (on the web visit [www.sears.com](http://www.sears.com) for replacement cooktop cleaner, item number 40079). Buff with a **non-abrasive** cloth or **no-scratch** cleaning pad. This will make cleaning easier when soiled from cooking. The special cooktop cleaning cream leaves a protective finish on the glass to help prevent scratches and abrasions.

Sliding aluminum or copper clad bottom pans on the cooktop can cause metal markings on the cooktop surface. These marks should be removed **immediately** after the cooktop has cooled using the cooktop cleaning cream. Metal marks can become permanent if not removed prior to future use.

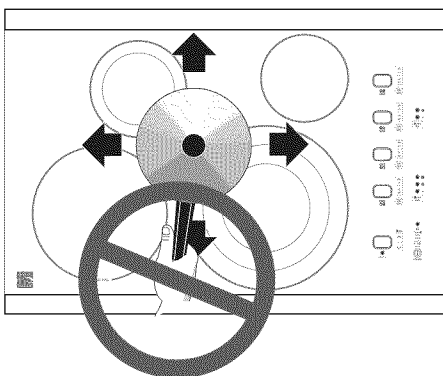

Cookware (cast iron, metal, ceramic or glass) with rough bottoms can mark or scratch the cooktop surface. **Do not slide anything metal or glass** across the cooktop. **Do not** use your cooktop as a cutting board or work surface in the kitchen. **Do not** cook foods directly on the cooktop surface without a pan. **Do not** drop heavy or hard objects on the glass cooktop, because they may cause it to crack.

## Cleaning Recommendations for the Ceramic Glass Cooktop

**CAUTION** Before cleaning the cooktop, be sure the controls are turned to **OFF** and the cooktop is **COOL**.  
**WARNING** **DO NOT** use a cooktop cleaner on a hot cooktop. The fumes can be hazardous to your health, and can chemically damage the ceramic glass surface.

### For light to moderate soil:

Apply a few drops of CookTop® Cleaning Creme directly to the cooktop. Use a paper towel or use a **non-abrasive** plastic type **no-scratch** pad to clean the entire cooktop surface. Make sure the cooktop is cleaned thoroughly, leaving no residue.

### For heavy, burned on soil:

Apply a few drops of CookTop® Cleaning Creme directly to the soiled area. Rub the soiled area using a **non-abrasive** plastic type **no-scratch** pad, applying pressure as needed. Do not use the pad you use to clean the cooktop for any other purpose.

# General Care & Cleaning

## Cleaning Recommendations for the Ceramic Glass Cooktop

If soils remain, carefully scrape soils with a metal razor blade scraper, holding scraper at a 30 degree angle to the surface. Reapply CookTop® Cleaning Creme and buff surface clean.

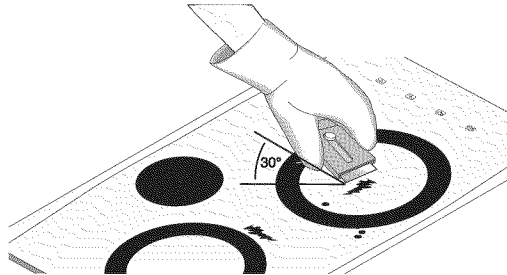

**IMPORTANT NOTE:** Damage to the ceramic glass cooktop may occur if you use an abrasive type scratch pad. Only use cleaning products that have been specifically designed for ceramic glass cooktop.

### Plastic or foods with a high sugar content:

These types of soils need be removed immediately if spilled or melted onto the ceramic cooktop surface. Permanent damage (such as pitting of the cooktop surface) may occur if not removed **immediately**. After turning the surface elements OFF, use a razor blade scraper or a metal spatula with a mitt and scrape the soil from the hot surface (as illustrated). Allow the cooktop to cool, and use the same method for heavy or burned on soils.

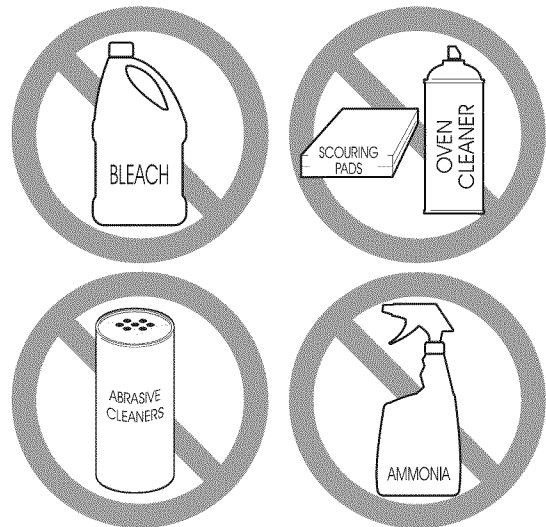

### Do not use the following on the ceramic glass cooktop:

- Do not use abrasive cleaners and scouring pads, such as metal and some nylon pads. They may scratch the cooktop, making it more difficult to clean.
- Do not use harsh cleaners, such as chlorine bleach, ammonia or oven cleaners, as they may etch or discolor the cooktop.
- Do not use dirty sponges, cloths or paper towels, as they can leave soil or lint on the cooktop which can burn and cause discoloration.

### Special Caution for Aluminum Foil and Aluminum Cooking Utensils

- **Aluminum foil**  
Use of aluminum foil will damage the cooktop. Do not use under any circumstances.
- **Aluminum utensils**  
Since the melting point of aluminum is much lower than that of other metals, care must be taken when aluminum pots or pans are used. Pans that boil dry may permanently damage cooktop by breaking, fusing to, or marking it.

### Care and Cleaning of Stainless Steel (some models)

Some models are equipped with stainless steel exterior parts. Special care and cleaning are **required** for maintaining the appearance of stainless parts. Refer to the **General Care & Cleaning** table for detailed cleaning instructions.

# Before You Call

OCCURRENCE	POSSIBLE CAUSE/SOLUTION
<b>Entire cooktop does not operate.</b>	House fuse has blown or circuit breaker has tripped. Check/reset breaker or replace fuse. If the problem is a circuit overload, have this situation corrected by a qualified electrician.
	Wiring connection is not complete. Call 1-800-4-MY-HOME® for service (see back cover).
	Power outage. Check house lights to be sure. Call your local electric company for service.
<b>Error code is shown.</b>	Mechanical interference with control panel touch pads. Make sure nothing rests on the control panel. Clean cooktop surface is required. Call 1-800-4-MY-HOME® for service (see back cover).
<b>Surface element does not heat.</b>	No power to the appliance. Check steps under “Entire Cooktop Does Not Operate” in this <b>Before You Call</b> checklist.
	Too low heat setting. Turn control to a slightly higher setting until element comes on.
	Incorrect control is on. Be sure to use correct control for the element to be used.
<b>Surface element too hot or not hot enough.</b>	Incorrect control setting. Raise or lower setting until proper amount of heat is obtained. Dial markings are an indicator of relative heat settings and will vary slightly.
	Voltage is incorrect. Be sure appliance is properly connected to the specified power source. If you are not sure about this requirement call 1-800-4-MY-HOME® for service (see back cover).
	Lightweight or warped pans were used. Be sure to use proper cookware. Use only flat bottom, evenly balanced medium or heavyweight cookware. Heavy and medium weight pans heat evenly. Because lightweight pans heat unevenly, foods may burn easily.
	Food not heating evenly.
<b>Scratches or abrasions on Ceramic glass cooktop surface.</b>	Lightweight or warped pans were used. Be sure to use proper cookware. Use only flat bottom, evenly balanced medium or heavyweight cookware. Heavy and medium weight pans heat evenly. Because lightweight pans heat unevenly, foods may burn easily.
	Incorrect control setting. Raise or lower setting until proper amount of heat is obtained.
	Coarse particles such as salt or sand between cooktop and utensils can cause scratches. Be sure cooktop surface and bottoms of utensils are clean before usage. Small scratches do not affect cooking and will become less visible with time.
<b>Metal marks on Ceramic glass cooktop surface.</b>	Cleaning materials not recommended for ceramic-glass cooktop have been used. See <b>Ceramic Glass Cooktop Cleaning &amp; Maintenance</b> in this Use and Care Guide.
	Cookware with rough bottom has been used. Use smooth, flat-bottomed cookware.
	Sliding or scraping of metal utensils on cooktop surface. Do not slide metal utensils on cooktop surface. Use a ceramic-glass cooktop cleaning cream to remove the marks. See <b>Ceramic Glass Cooktop Cleaning &amp; Maintenance</b> in this Use and Care Guide.
<b>Brown streaks and specks on Ceramic glass cooktop surface.</b>	Boilovers have cooked onto surface. Use razor blade scraper to remove soil. See <b>Ceramic Glass Cooktop Cleaning &amp; Maintenance</b> in this Use and Care Guide.
	Cleaning materials not recommended for ceramic-glass cooktop have been used. Use recommended cleaners and cleaning method. See <b>Ceramic Glass Cooktop Cleaning &amp; Maintenance</b> in this Use and Care Guide.
<b>Areas of discoloration on Ceramic glass cooktop surface.</b>	Mineral deposits from water and food. Remove using a ceramic-glass cooktop cleaning creme. To avoid this occurrence use cookware with clean, dry bottoms.

# PROTECTION AGREEMENTS

## Master Protection Agreements

*Congratulations on making a smart purchase.* Your new Kenmore® product is designed and manufactured for years of dependable operation. But like all products, it may require preventive maintenance or repair from time to time. That's when having a Master Protection Agreement can save you money and aggravation.

The Master Protection Agreement also helps extend the life of your new product. Here's what the Agreement\* includes:

- ☑ **Parts and labor** needed to help keep products operating properly **under normal use**, not just defects. Our coverage goes **well beyond the product warranty**. No deductibles, no functional failure excluded from coverage – **real protection**.
- ☑ **Expert service** by a force of more than **10,000 authorized Sears service technicians**, which means someone you can trust will be working on your product.
- ☑ **Unlimited service calls and nationwide service**, as often as you want us, whenever you want us.
- ☑ **«No-lemon» guarantee** – replacement of your covered product if four or more product failures occur within twelve months.
- ☑ **Product replacement** if your covered product can't be fixed.
- ☑ **Annual Preventive Maintenance Check** at your request – no extra charge.
- ☑ **Fast help by phone** – we call it **Rapid Resolution** – phone support from a Sears representative on all products. Think of us as a «talking owner's manual».
- ☑ **Power surge protection** against electrical damage due to power fluctuations.
- ☑ **\$250 Food Loss Protection** annually for any food spoilage that is the result of mechanical failure of any covered refrigerator or freezer.
- ☑ **Rental reimbursement** if repair of your covered product takes longer than promised.
- ☑ **10% discount** off the regular price of any non-covered repair service and related installed parts.

Once you purchase the Agreement, a simple phone call is all that it takes for you to schedule service. You can call anytime day or night, or schedule a service appointment online.

The Master Protection Agreement is a risk free purchase. If you cancel for any reason during the product warranty period, we will provide a full refund. Or, a prorated refund anytime after the product warranty period expires. Purchase your Master Protection Agreement today!

**Some limitations and exclusions apply. For prices and additional information in the U.S.A. call 1-800-827-6655.**

\* Coverage in Canada varies on some items. For full details call Sears Canada at 1-800-361-6665.

## Sears Installation Service

For Sears professional installation of home appliances, garage door openers, water heaters, and other major home items, in the U.S.A. or Canada call **1-800-4-MY-HOME®**.

## Acuerdos maestros de protección

*Enhorabuena por haber hecho una compra inteligente.* Su nuevo producto Kenmore® está diseñado y fabricado para brindarle años de funcionamiento fiable. Pero, como cualquier producto, puede necesitar mantenimiento preventivo o reparaciones periódicas. Es por eso que tener un Acuerdo maestro de protección podría ahorrarle dinero y molestias.

El Acuerdo maestro de protección también sirve para prolongar la durabilidad de su nuevo producto. El acuerdo\* incluye lo siguiente:

- ☑ **Piezas y mano de obra** necesarias para contribuir a mantener el funcionamiento adecuado de los productos **utilizados en condiciones normales de uso**, no sólo en caso de defectos de los productos. Nuestra cobertura va **mucho más allá que la garantía del producto**. No se aplican deducibles ni exclusiones por fallas del funcionamiento: es decir, **verdadera protección**.
- ☑ **Servicio técnico por expertos** (más de **10000 técnicos autorizados de Sears**), lo cual significa que quien repare o realice el mantenimiento de su producto será un profesional de confianza.
- ☑ **Servicio técnico a escala nacional y número ilimitado de llamadas de solicitud de servicio técnico**: se puede poner en contacto con nosotros cuantas veces lo desee y cuando lo desee.
- ☑ **Garantía «sin sorpresas»**: se reemplaza el producto cubierto por el acuerdo si ocurren cuatro o más fallas del producto en un periodo de 12 meses.
- ☑ **Reemplazo del producto**: en caso de que no se pueda reparar el producto cubierto por el acuerdo.
- ☑ **Revisión anual preventiva de mantenimiento del producto**: puede solicitarla en cualquier momento, sin costo alguno.
- ☑ **Rápida asistencia telefónica**, la cual denominamos **Solución rápida**: es decir, asistencia telefónica a través de cualquiera de nuestros representantes de Sears, sobre cualquiera de nuestros productos. Piense en nosotros como en un «manual parlante del usuario».
- ☑ **Protección contra fallas eléctricas**, contra daños debidos a fluctuaciones de la corriente eléctrica.
- ☑ **\$250 al año para cubrir cualquier posible deterioro de alimentos** que haya tenido que desechar debido a una falla mecánica de cualquiera de nuestros refrigeradores o congeladores cubiertos por este acuerdo.
- ☑ **Devolución de gastos de alquiler de electrodomésticos** si la reparación de su producto asegurado toma más que el tiempo prometido.
- ☑ **10% de descuento** aplicable tanto a los costos del servicio de reparación, como de las piezas instaladas relacionadas que no hayan quedado cubiertos por este acuerdo.

Una vez que haya realizado el pago de este acuerdo, bastará una simple llamada telefónica para concertar una visita de servicio. Puede llamar a cualquier hora del día o de la noche, o bien concertar una visita de servicio por Internet.

La adquisición del Acuerdo maestro de protección es una inversión exenta de riesgos. Si por cualquier motivo decide cancelar dicho acuerdo durante el periodo de garantía del producto, le haremos un reintegro total del valor. O bien un importe proporcional si cancela el acuerdo en cualquier otro momento posterior al vencimiento del periodo de garantía del producto. ¡Adquiera hoy mismo su Acuerdo maestro de protección!

**Algunas limitaciones y exclusiones podrían aplicarse. Para solicitar precios e información adicional, llame al 1-800-827-6655 (en los EE.UU.).**

\* La cobertura en Canadá varía en el caso de algunos artículos. Para obtener detalles completos al respecto, llame al 1-800-361-6665 de Sears de Canadá.

## Servicio de instalación de Sears

Para solicitar la instalación por profesionales de Sears de electrodomésticos, abridores de puertas de garaje, calentadores de agua y otros artículos de uso prioritario en el hogar, llame al **1-800-4-MY-HOME** en los EE.UU. o Canadá.

# Get it fixed, at your home or ours!

## Your Home

For troubleshooting, product manuals and expert advice:



[www.managemylife.com](http://www.managemylife.com)

---

For repair – **in your home** – of **all** major brand appliances, lawn and garden equipment, or heating and cooling systems, **no matter who made it, no matter who sold it!**

For the replacement parts, accessories and owner's manuals that you need to do-it-yourself.

For Sears professional installation of home appliances and items like garage door openers and water heaters.

**1-800-4-MY-HOME<sup>®</sup>** (1-800-469-4663)

Call anytime, day or night (U.S.A. and Canada)

[www.sears.com](http://www.sears.com)      [www.sears.ca](http://www.sears.ca)

---

## Our Home

For repair of carry-in items like vacuums, lawn equipment, and electronics, call anytime for the location of your nearest

**Sears Parts & Repair Service Center**

**1-800-488-1222** (U.S.A.)

[www.sears.com](http://www.sears.com)

**1-800-469-4663** (Canada)

[www.sears.ca](http://www.sears.ca)

---

To purchase a protection agreement on a product serviced by Sears:

**1-800-827-6655** (U.S.A.)

**1-800-361-6665** (Canada)

---

Para pedir servicio de reparación a domicilio, y para ordenar piezas:

**1-888-SU-HOGAR<sup>®</sup>**

(1-888-784-6427)

[www.sears.com](http://www.sears.com)

Au Canada pour service en français:

**1-800-LE-FOYER<sup>MC</sup>**

(1-800-533-6937)

[www.sears.ca](http://www.sears.ca)

The Sears logo, featuring the word "Sears" in a large, bold, serif font with a stylized 'S'.

© Registered Trademark / <sup>TM</sup> Trademark of KCD IP, LLC in the United States, or Sears Brands, LLC in other countries

© Marca Registrada / <sup>TM</sup> Marca de Fábrica de KCD IP, LLC en Estados Unidos, o Sears Brands, LLC in otros países

<sup>MC</sup> Marque de commerce / <sup>MD</sup> Marque déposée de Sears Brands, LLC



## Free Manuals Download Website

<http://myh66.com>

<http://usermanuals.us>

<http://www.somanuals.com>

<http://www.4manuals.cc>

<http://www.manual-lib.com>

<http://www.404manual.com>

<http://www.luxmanual.com>

<http://aubethermostatmanual.com>

Golf course search by state

<http://golfingnear.com>

Email search by domain

<http://emailbydomain.com>

Auto manuals search

<http://auto.somanuals.com>

TV manuals search

<http://tv.somanuals.com>