

Use & Care Guide  
Manual de Uso y Cuidado  
English / Español

Model/Modèle: 790-4942\*, 790-4940\*

# Kenmore®

## Electric Built-In Oven

## Horno de pared doble

\* = color number, número de color

P/N 139900101 Rev. A

Sears Brands Management Corporation  
Hoffman Estates, IL 60179 U.S.A.  
[www.kenmore.com](http://www.kenmore.com)  
[www.sears.com](http://www.sears.com)

Sears Canada Inc.  
Toronto (Ontario) Canada M5B 2B8  
[www.sears.ca](http://www.sears.ca)



# Table of Contents

Please carefully read and save these instructions .....	2	Self Clean .....	17
Kenmore Limited Warranty .....	2	Care and Cleaning .....	19
Before Setting Oven Controls .....	7	Cleaning Various Parts of Your Oven .....	19
Oven vent location .....	7	Removing and Replacing the Oven Door .....	20
Oven Controls .....	8	Replacing the oven light .....	21
Oven Control Features .....	8	Before You Call .....	22
Minimum and Maximum Control Settings .....	8	Oven Baking .....	22
		Solutions to Common Problems .....	23

---

## Please carefully read and save these instructions

This Use & Care Guide contains operating instructions for your appliance and feature information for several models. Your product may not have all the described features. The graphics shown are representative. The graphics on your appliance may not look exactly like those shown. Common sense and caution must be practiced with installing, operating and maintaining any appliance.

## Kenmore Limited Warranty

When installed, operated and maintained according to all instructions supplied with the product, if this appliance fails due to a defect in material and workmanship within one year from the date of purchase, call 1-800-4-MY-HOME® to arrange for free repair. This warranty applies for only 90 days from the date of purchase if this appliance is ever used for other than private family purposes.

### This warranty covers only defects in material and workmanship. Sears will not pay for:

1. Cracks in a ceramic glass cooktop that are not a result of thermal shock.
2. Stains and scratches on a ceramic glass cooktop resulting from failure to maintain it properly according to all instructions supplied with the product.
3. Expendable items that can wear out from normal use, including but not limited to filters, belts, light bulbs, and bags.
4. A service technician to instruct the user in correct product installation, operation or maintenance.
5. A service technician to clean or maintain this product.
6. Damage to or failure of this product if it is not installed, operated or maintained according to all instructions supplied with the product.
7. Damage to or failure of this product resulting from accident, abuse, misuse or use for other than its intended purpose.
8. Damage to or failure of this product caused by the use of detergents, cleaners, chemicals or utensils other than those recommended in all instructions supplied with the product.
9. Damage to or failure of parts or systems resulting from unauthorized modifications made to this product.

### Disclaimer of implied warranties; limitation of remedies

Customer's sole and exclusive remedy under this limited warranty shall be product repair as provided herein. Implied warranties, including warranties of merchantability or fitness for a particular purpose, are limited to one year or the shortest period allowed by law. Sears shall not be liable for incidental or consequential damages. Some states and provinces do not allow the exclusion or limitation of incidental or consequential damages, or limitation on the duration of implied warranties of merchantability or fitness, so these exclusions or limitations may not apply to you.

This warranty applies only while this appliance is used in the United States or Canada.

This warranty gives you specific legal rights, and you may also have other rights which vary from state to state.

**Sears Brands Management Corporation, Hoffman Estates, IL 60179 U.S.A.**  
**Sears Canada Inc., Toronto, Ontario, Canada M5B 2B8**

# IMPORTANT SAFETY INSTRUCTIONS

Read all instructions before using this appliance.

Read all instructions before using this appliance.

This manual contains important safety symbols and instructions. Pay attention to these symbols and follow all instructions given.

Do not attempt to install or operate your appliance until you have read the safety precautions in this manual. Safety items throughout this manual are labeled with a WARNING or CAUTION statement based on the hazard type.

## DEFINITIONS

**⚠** This is the safety alert symbol. It is used to alert you to potential personal injury hazards. Obey all safety messages that follow this symbol to avoid possible injury or death.

**⚠ WARNING** - Indicates a potentially hazardous situation which, if not avoided, may result in death or serious injury.

**⚠ CAUTION** - Indicates a potentially hazardous situation which, if not avoided, may result in minor or moderate injury.

**Important:** Indicates installation, operation, maintenance, or valuable information that is not hazard related.

**⚠ WARNING** Storage In or On Appliance—Flammable materials should not be stored in an oven or near surface units. This includes paper, plastic, and cloth items, such as cookbooks, plastic ware, and towels, as well as flammable liquids. Do not store explosives, such as aerosol cans, on or near the oven.

## **⚠ WARNING** Tip Over Hazard



- A child or adult can tip the oven and be killed.
- Install the anti-tip device to oven and/or structure per installation instructions.

- Ensure the anti-tip device is re-engaged when the oven is moved.
- Do not operate the oven without the anti-tip device in place and engaged.
- Failure to follow these instructions can result in death or serious burns to children and adults.

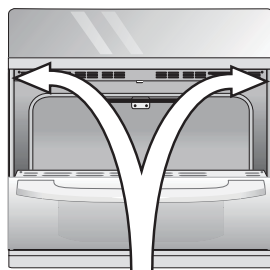

Anti-tip mounting holes

Refer to the installation instructions supplied with your appliance for proper installation.

Check for proper installation with a visual check that the anti-tip screws are present.

Test the installation with light downward pressure on the open oven door. The oven should not tip forward.

**⚠ WARNING** Do Not Leave Children Alone - Children should not be left alone or unattended in the area where appliance is in use. They should never be allowed to sit or stand on any part of the appliance, including the storage drawer, lower broiler drawer, warmer drawer, or lower double oven.

Save these instructions for future reference.

# IMPORTANT SAFETY INSTRUCTIONS

Read all instructions before using this appliance.

**⚠ WARNING** Stepping, leaning, or sitting on the door or drawers of an oven can result in serious injuries and also cause damage to the appliance. Do not allow children to climb or play around the oven. The weight of a child on an open oven door may cause the oven to tip, resulting in serious burns or other injury.

**⚠ WARNING** Never cover any slots, holes, or passages in the oven bottom or cover an entire oven rack with materials, such as aluminum foil. Aluminum foil linings may trap heat, causing a fire hazard.

**⚠ CAUTION** Wear proper apparel. Loose-fitting or hanging garments should never be worn while using this appliance. Do not let clothing or other flammable materials come into contact with hot surfaces.

**⚠ CAUTION** Do not heat unopened food containers. Build-up of pressure may cause container to burst and result in injury.

**⚠ CAUTION** When heating fat or grease, watch it closely. Grease may catch fire if it becomes too hot.

**⚠ CAUTION** Do not use water or flour on grease fires. Smother fire or flame or use dry chemical or foam-type extinguisher. Cover the fire with a pan lid or use baking soda.

**⚠ CAUTION** Use dry potholders. Moist or damp potholders on hot surfaces may result in burns from steam. Do not let potholders touch hot cooking areas. Do not use towels or other bulky cloths.

**Important:** Important Safety Notice - The California Safe Drinking Water and Toxic Enforcement Act requires the governor of California to publish a list of substances known to cause cancer, birth defects, or other reproductive harms, and it requires businesses to warn customers of potential exposures to such substances.

**⚠ CAUTION** Read and follow the below instructions and precautions for unpacking, installing, and servicing your appliance:

- Remove all tape and packaging before using the oven. Destroy the carton and plastic bags after unpacking the oven. Never allow children to play with packaging material.
- Proper Installation—Be sure your appliance is properly installed and grounded by a qualified technician in accordance with the National Electrical Code ANSI/NFPA No. 70 latest edition and local electrical code requirements. In Canada, install in accordance with CSA Standard C22.1, Canadian Electrical code, Part 1, and local electrical code requirements. Install only per installation instructions provided in the literature package for this oven.
- User Servicing—Do not repair or replace any part of the appliance unless specifically recommended in the manuals. All other servicing should be done only by a qualified technician. This reduces the risk of personal injury and damage to the oven.
- Ask your dealer to recommend a qualified technician and an authorized repair service. Know how to disconnect the power to the oven at the circuit breaker or fuse box in case of an emergency.
- Never modify or alter the construction of an oven by removing the leveling legs, panels, wire covers, anti-tip brackets/screws, or any other part of the oven.
- Remove the oven door from any unused oven if it is to be stored or discarded.

Save these instructions for future reference.

# IMPORTANT SAFETY INSTRUCTIONS

Read all instructions before using this appliance.

- Do not attempt to operate the oven during a power failure. If the power fails, always turn off the oven. If the oven is not turned off and the power resumes, the oven will begin to operate again. Once the power resumes, reset the clock and oven function.
- Cold temperatures can damage the electronic control. When using this appliance for the first time, or when the appliance has not been used for an extended period of time, be sure the appliance has been in temperatures above 32°F (0°C) for at least 3 hours before turning on the power to the appliance.
- Be sure to have an appropriate foam-type fire extinguisher available, visible, and easily located near the appliance.
- Do not use a broiler pan without its insert. Broiler pans and inserts allow dripping fat to drain away from the high heat of the broiler. Do not cover the broiler insert with aluminum foil; exposed fat and grease could ignite.
- Protective Liners - Do not use aluminum foil to line surface unit drip bowls or oven bottoms, except as suggested in the manual. Improper installation of these liners may result in a risk of electric shock, or fire.
- Do not cook food on the oven bottom. Always cook in proper bakeware and always use the oven racks.

## IMPORTANT INSTRUCTIONS FOR USING YOUR OVEN

- Never use your appliance for warming or heating the room.
- Use care when opening oven door, lower oven door, or warmer drawer (some models). Stand to the side of the oven when opening the door of a hot oven. Let hot air or steam escape before you remove or replace food in the oven.
- Keep oven vent ducts unobstructed. Touching surfaces in this area when the oven is on may cause severe burns. Do not place plastic or heat-sensitive items on or near the oven vent. These items can melt or ignite.
- Placement of Oven Racks - Always place oven racks in desired location while oven is cool. If rack must be moved while oven is hot, do not let potholder contact hot heating element in oven. Use potholders and grasp the rack with both hands to reposition. Remove all bakeware and utensils before moving the rack.

## IMPORTANT INSTRUCTIONS FOR CLEANING YOUR OVEN

**⚠ CAUTION** Before manually cleaning any part of the oven, be sure all controls are turned off and the oven is cool. Cleaning a hot oven can cause burns.

Clean the oven regularly to keep all parts free of grease that could catch fire. Do not allow grease to accumulate.

Always follow the manufacturer's recommended directions for use of kitchen cleaners and aerosols. Be aware that excess residue from cleaners and aerosols may ignite causing damage and injury.

Clean ventilating hoods frequently. Grease should not be allowed to accumulate on the hood or filter. Follow the manufacturer's instructions for cleaning hoods.

Save these instructions for future reference.

# IMPORTANT SAFETY INSTRUCTIONS

Read all instructions before using this appliance.

## SELF-CLEANING OVENS

- Clean only the parts listed in this manual. Before using self-clean, remove the broiler pan, any food, utensils, and bakeware from the oven. Remove oven racks unless otherwise instructed.
- Do Not Use Oven Cleaners. No commercial oven cleaner or oven liner protective coating of any kind should be used in or around any part of the oven.
- Do Not Clean Door Gasket. The door gasket is essential for a good seal. Care should be taken not to rub, damage, or move the gasket.
- Some birds are extremely sensitive to the fumes given off during the self-clean cycle of any oven. Move birds to another well-ventilated room.

## GROUNDING INSTRUCTIONS

**⚠ WARNING** Do not use an adapter plug or an extension cord, or remove grounding prong from the power cord. Failure to follow this warning may cause serious injury, fire, or death.

For personal safety, this appliance must be properly grounded.

**For models factory-equipped with a power cord:**

For maximum safety, the power cord must be plugged into an electrical outlet that is the correct voltage, is correctly polar-ized, and is properly grounded in accordance with local codes.

**For ovens to be wired into a junction box:**

It is the personal responsibility of the consumer to have the appropriate outlet with the correct, properly grounded wall receptacle installed by a qualified electrician. See the installation instructions packaged with

this appliance for complete installation and grounding instructions.

**⚠ CAUTION** DO NOT TOUCH HEATING ELEMENTS OR INTERIOR SURFACES OF OVEN - Heating elements may be hot even though they are dark in color. Interior surfaces of an oven become hot enough to cause burns. During and after use, do not touch, or let clothing or other flammable materials contact heating elements or interior surfaces of oven until they have had sufficient time to cool. Other surfaces of the appliance may become hot enough to cause burns - among these surfaces are (identification of surfaces - for example, oven vent openings and surfaces near these openings, oven doors, and windows of oven doors).

Save these instructions for future reference.

# Before Setting Oven Controls

## Oven vent location

The oven vent is located under the control panel. When the oven is on, warm air passes through this vent. This venting is necessary for proper air circulation in the oven and good baking results. Do not block oven vent.

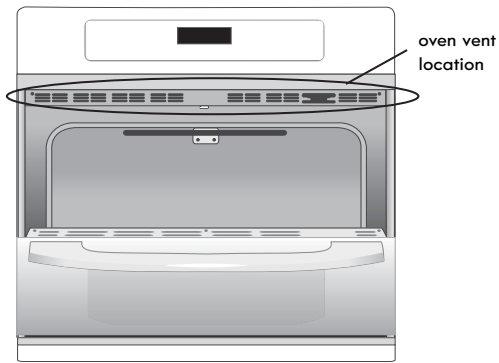

Figure 1: Do not block oven vent location

**⚠ WARNING** Protective Liners — Do not use aluminum foil to line the oven bottom. Only use aluminum foil as recommended in this manual. Improper installation of these liners may result in risk of electric shock or fire.

**⚠ CAUTION** Always use pot holders or oven mitts when using the oven. When cooking, the oven interior and exterior, as well as the oven racks, will become very hot which can cause burns.

### Removing, replacing, and arranging flat or offset oven racks

To Arrange - Always arrange the oven racks when the oven is cool (prior to operating the oven).

To Remove - Pull the oven rack straight forward until it reaches the stop position. Lift up front of oven rack slightly and slide out.

To Replace - Place the oven rack on the rack guides on both sides of oven walls. Tilt the front of oven rack upward slightly and slide the oven rack back into place. Be sure oven racks are level before using.

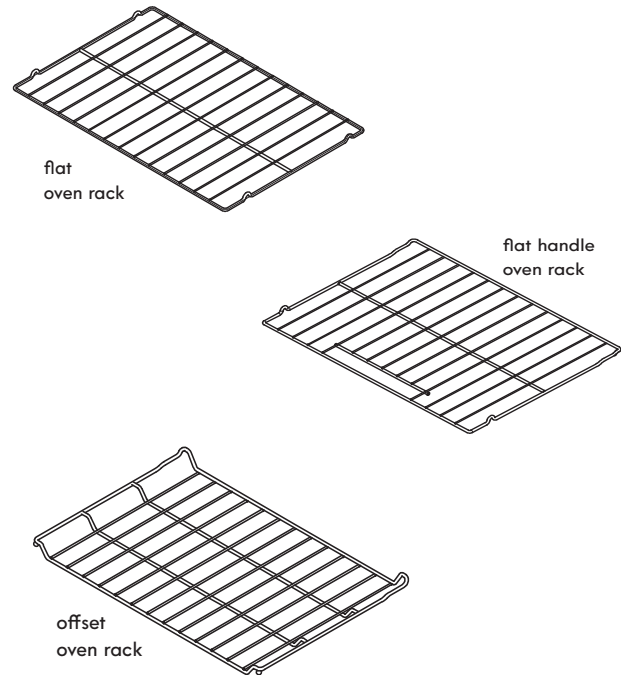

Figure 2: Oven rack types

### Oven Rack Descriptions

- Flat oven racks (or the flat handle oven rack) may be used for most cooking needs and may be placed in most oven rack positions.
- The offset oven rack (some models) provides additional step down positions from the standard flat rack design. The offset design positions the base of the rack about half of a rack position lower than the flat rack and may be used in most oven rack positions.

### Air circulation in the oven

For best air circulation when baking, allow a space of 2 inches (5 cm) around the bakeware for proper air circulation. Be sure pans and bakeware do not touch each other, the oven door, sides, or back of the oven cavity.

Hot air must be able to circulate around bakeware for even heat to reach the food.

# Oven Controls

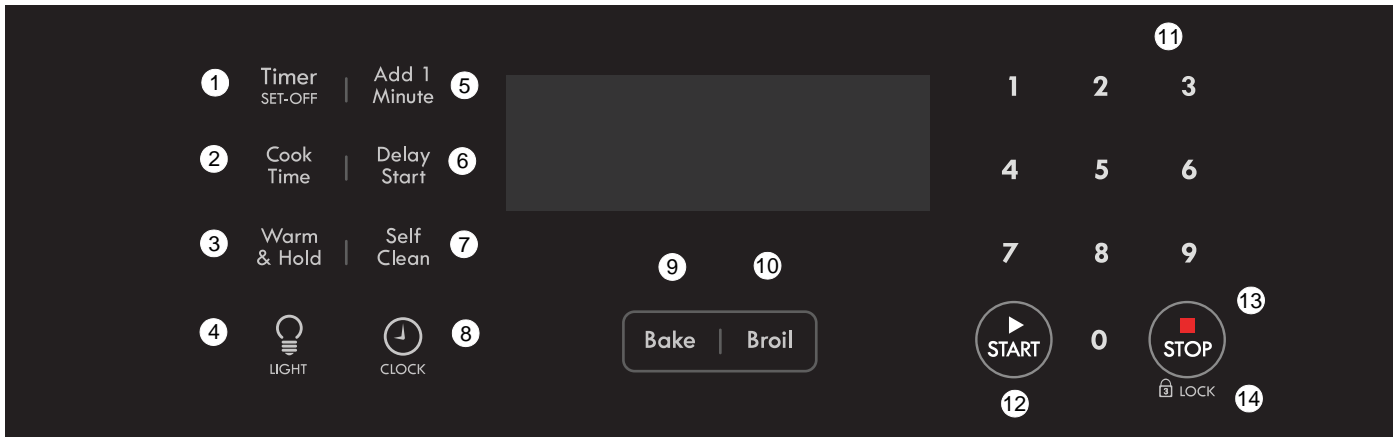

## Oven Control Features

1. **Timer Set-Off** - Use to set or cancel the timer.
2. **Cook Time** - Use to enter length of desired cooking time.
3. **Warm & Hold** - Use to select Warm & Hold function.
4. **Oven Light** - Use to turn oven lights on and off.
5. **Add 1 Minute** - Use to add one minute to the timer. This works with the kitchen timer and does not affect any cook time or start time functions.
6. **Delay Start** - Use to set the desired start time for baking. May be used with Cook Time to program a delayed bake cycle or a delayed clean cycle.
7. **Self Clean** - Use to set a 2, 3, or 4 hour self clean cycle.
8. **Clock** - Use to set time of day.
9. **Bake** - Use to start the regular bake function.
10. **Broil** - Use to select the broil function.
11. **0-9 Keypads** - Use to enter oven temperatures and times.
12. **START** - Use to start oven functions.
13. **STOP** - Use to clear any function previously entered except the time of day and minute timer. Press **STOP** to stop cooking. Also, the **STOP** key is used to activate oven lockout setting.
14. **Oven Lockout** - Use in conjunction with the **STOP** key to lock out oven functions and door.

### Important:

Read the instructions carefully before using the oven. For satisfactory use of your oven, become familiar with the various functions of the oven.

## Minimum and Maximum Control Settings

All of the features listed have minimum and maximum time and temperature settings that may be entered into the control. An entry acceptance beep will sound each time a key is touched (the Oven Lockout tone is delayed by 3 seconds). An entry error tone (three short beeps) will sound if the entry of the temperature or time is below the minimum or above the maximum settings for the feature.

**Table 1: Minimum and maximum control settings**

Feature	Min. Temp or Time	Max. Temp or Time
Bake	170°F (77°C)	550°F (288°C)
Broil	400°F (205°C)	550°F (288°C)
Timer	1 minute	11 hrs. 59 mins.
Self Clean	2 Hours	4 Hours
Warm & Hold	170°F (77°C)	3 Hours
Cook Time	1 Minute	11:59
Delay Time 12 Hr.	1:00	12:59
Delay Time 24 Hr.	0:00	23:59
Clock 12 Hr.	1:00	12:59
Clock 24 Hr.	0:00	23:59



## Setting the Clock

When the appliance is first powered on, 12:00 will flash in the display (See [Figure 3](#)). The time of day must first be set before operating the oven.



Figure 3: 12:00

### To set clock for 1:30:

1. Press .
2. Enter 1 3 0 using numeric keypad.
3. Press .

### Important note:

The clock cannot be changed when a Cook Time, Self Clean, Delay Start, or cooking feature is active.

## Setting Timer

The minute timer allows you to track your cooking times without interfering with the cooking process. The timer may be set from a minimum time of 1 minute to a maximum of 11 hours and 59 minutes.

### To set timer for 5 minutes:

1. Press **Timer Set-Off**.
2. Enter 5 using numeric keypad.
3. Press . When the time runs out, **END** appears in the display, and the control will beep three times every 30 seconds until **Timer Set-Off** is pressed.

To cancel the timer when active, press **Timer Set-Off** again.

### Important:

- The timer does not start or stop the cooking process. It serves as an extra minute timer that will sound an alert tone when the set time has run out. The timer may be used alone or while using any of the other oven functions.
- When the timer is set for more than 1 hour it will display hours and minutes until 1 hour remains. When less than 1 hour remains, the display counts down in minutes and seconds. With less than 1 minute remaining, only seconds will display.
- If the timer is active during a cooking process, the timer will show in the display. To view the status of any other active oven function, press the key of the cooking function once and it will appear in the display for a few seconds.

## Add 1 Minute

Use the **Add 1 Minute** key to set additional minutes to the timer. Each press of the key will add 1 additional minute. If the **Add 1 Minute** key is pressed when the timer is not active, the timer will activate and begin counting down from 1 minute.

### To add 2 minutes to the timer:

Press **Add 1 Minute** twice.

## Setting 12 or 24 Hour Display Mode

The clock display mode allows you to choose between the 12 or 24 hour modes. The factory pre-set clock display mode is 12 hours.

### To set 12 or 24 hour display mode:



1. Press and hold  for 6 seconds.
2. Press **Self Clean** to toggle between 12 Hr day or 24 Hr day display modes (See [Figure 4](#) and [Figure 5](#)).
3. Press  to accept choice.



Figure 4: 12 Hr dAy



Figure 5: 24 Hr dAy

## Changing Between Continuous Bake Setting or 12 Hour Energy Saving Feature

The oven control has a factory preset 12 hour energy saving feature that will turn off the oven after 12 hours. The control may be programmed to override this feature to bake continuously.

### To change between continuous bake or 12 hour energy saving feature:

1. Press and hold **Timer Set-Off** for 6 seconds
2. Press **Self Clean** to toggle between 12 Hour OFF ([Figure 6](#)) or Stay On ([Figure 7](#)) feature.
3. Press  to accept choice



Figure 6: 12 Hr Off



Figure 7: Stay On

## Oven Controls

### Changing Oven Temperature Display

The oven control is preset to display temperatures in Fahrenheit (°F) when shipped from the factory. The control can be changed to display either (°F) or Celsius (°C).

#### To change the temperature to display °C or °F:

1. Press and hold **Broil** for 6 seconds.
2. Once **F** (or **C**) appears in the display, press **Self Clean** to toggle between (°F) and (°C) temperature display modes (See [Figure 8](#) and [Figure 9](#)).
3. Press  to accept choice.

#### Important note:

The oven temperature display cannot be changed during the cooking process, if a Delay Start has been set, or if Self Clean is active.



Figure 8: Fahrenheit



Figure 9: Celsius

### Setting Silent or Audible Control Mode

Silent mode allows the oven control to operate without audible tones. The control may be programmed for silent operation and later reset to operate with all the normal audible tones.

#### To set for silent or audible mode:

1. Press and hold **Delay Start** for 6 seconds.
2. Press **Self Clean** key to toggle between beep on or beep off (See [Figure 10](#) and [Figure 11](#)).
3. Press  to accept choice.



Figure 10: bEEP On



Figure 11: bEEP Off

### Setting Oven Lockout

The control may be programmed to lock the oven door and lock the oven control.

#### To activate the oven lockout features:

1. Be sure oven door is completely closed.
2. Press and hold  for 3 seconds (see [Figure 12](#)). **door Loc** will appear in the display. The motor driven door latch mechanism will begin locking the oven door automatically. Do not open the oven door. Allow about 15 seconds for the oven door to completely lock. Once door is locked, **Loc** will appear in the display (See [Figure 13](#)).



Figure 12: door Loc



Figure 13: Loc

#### To cancel the oven lockout feature:

1. Press and hold  for 3 seconds. The motor door latch will begin unlocking the oven door automatically. Do not open the oven door. Allow about 15 seconds for the oven door to completely unlock.
2. When the **Loc** message ([Figure 13](#)) no longer displays, the oven door may be opened, and the oven control will be available for use.

#### Important note:

- To avoid possible damage to the oven door latching mechanism, do not attempt to open or close the oven door whenever the **door Loc** message is displayed.
- If a control key is pressed when Oven Lockout is active, the control may triple beep, indicating the key is not available when the Oven Lockout feature is active.

## Setting Bake

Use the bake feature whenever the recipe calls for baking using normal temperatures. A reminder tone will sound indicating when the set bake temperature is reached and to place the food in the oven.

Bake may be set for any oven temperature between 170°F (77°C) and 550°F (288°C).

### To set Bake with default temperature of 350°F:

1. Press **Bake**.

2. Press .

To cancel Bake at anytime, press .

### To set Bake for oven temperature of 425°F:

1. Press **Bake**.

2. Enter **4 2 5** using numeric keypad.

3. Press .

To cancel Bake at any time, press .

### Important note:

The oven is factory set to run no longer than 12 hours. If you wish to cook continuously, see [“Changing Between Continuous Bake Setting or 12 Hour Energy Saving Feature”](#) on page 9.

### Radiant Bake Rack Positions

- Fully preheat the oven before baking items like cookies, biscuits, and breads.
- When using any single rack, position the rack so that the food is in the center of the oven.
- For best results when baking cakes using two oven racks, place racks in positions 2 and 4 (See [Figure 15](#)).
- When baking using two oven racks, position bakeware as shown in [Figure 14](#). Allow at least 2 inches (5 cm) of space between bakeware for proper air circulation.
- Dark or dull pans absorb more heat than shiny bakeware, resulting in dark or overbrowning of foods. It may be necessary to reduce the oven temperature or cook time to prevent overbrowning of some foods. Dark pans are recommended for pies. Shiny pans are recommended for cakes, cookies, and muffins.

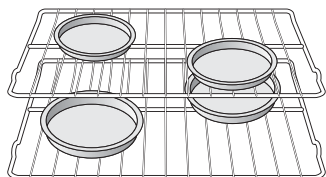

Figure 14: Pan placement

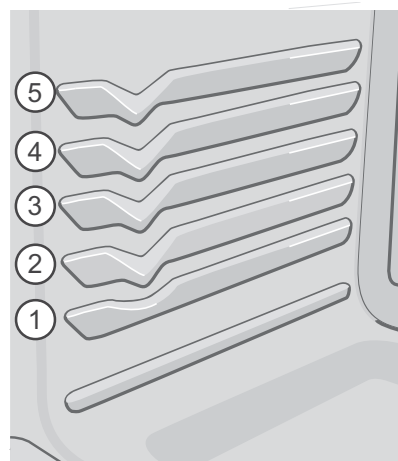

Figure 15: Rack position

### Setting Cook Time

Use Cook Time to program the oven control to automatically turn off after a desired length of time.

### To program oven to Bake with oven default temperature of 350°F and to shut-off after 30 minutes:

1. Press **Cook Time**.

2. Enter **3 0** using numeric keypad.

3. Press  to accept.

4. Press **Bake**.

5. Press .



Figure 16: End

When the programmed cook time ends, **End** will appear in the display window, and the oven will shut-off automatically (See [Figure 16](#)). The oven control will beep three times every 30 seconds as a reminder until  key is pressed.

### Important note:

- The Cook Time feature may be set with Bake. Cook Time or Delay Start will not operate with the Broil function. The maximum default Cook Time setting is 11 hours and 59 minutes.
- To check the time remaining during a timed cooking function, press **Cook Time** once and the time remaining will appear in the display momentarily.



## Oven Controls

### Setting Delay Start

The **Delay Start** feature delays starting time to oven cooking or cleaning functions. Prior to setting a delay start, be sure the time of day is set correctly.

**⚠ WARNING** Food Poisoning Hazard. Do not let food sit for more than one hour before or after cooking. Doing so can result in food poisoning or sickness. Foods that can easily spoil such as milk, eggs, fish, meat, or poultry should be chilled in the refrigerator first. Even when chilled, they should not stand in the oven for more than 1 hour before cooking begins and should be removed promptly when finished cooking.

**To program oven for a Delay Start beginning at 5:30, to shut-off automatically after 50 minutes, and for baking at 375°F:**

1. Press **Cook Time**. Enter **5 0** using numeric keypad.
2. Press  to accept.
3. Press **Delay Start**. Enter **5 3 0** using numeric keypad.
4. Press  to accept.
5. Press **Bake**. Enter **3 7 5** using numeric keypads.
6. Press .

The oven will begin the cooking process at 5:30. When the programmed cook time ends, **End** will appear in the display window, and the oven will shut off automatically (See [Figure 16](#)). The oven control will beep three times every 30 seconds as a reminder until  is pressed.

#### Important note:

Delay Start may be set using a 24 hour clock. See [“Setting 12 or 24 Hour Display Mode”](#) on [page 9](#) for more information. The Delay Start feature may be used with the Slow Cook and Self Clean. Delay Start or Cook Time will not operate with the Broil function.

### Warm & Hold™



Warm & Hold will keep cooked foods warm and ready for serving for up to 3 hours after cooking has finished. After 3 hours, the Warm & Hold will shut-off automatically. Warm & Hold should only be used with foods that are already at serving temperatures. Warm & Hold will maintain the oven temperature at 170° F (77°C).

#### To set Warm & Hold:

1. If needed, arrange oven racks and place cooked food in oven.
2. Press **Warm & Hold**. **Hld** will appear in the display. If no other keys are touched within 25 seconds, the request for Warm & Hold will clear.
3. Press . Warm & Hold will automatically turn off after 3 hours.

To turn Warm & Hold off at any time, press .



**To add Warm & Hold to automatically turn ON after baking 45 minutes with default oven set temperature of 350°F:**

1. Press **Cook Time**.
2. Enter **4 5** using numeric keypad.
3. Press **BAKE**.
4. Press  to accept.
5. Press **Warm & Hold**. **Hld** will appear in the display.
6. Press  to accept. When the cook time is over, the Warm & Hold will automatically turn on. The Warm & Hold function will automatically turn off after 3 hours.

#### Important note:

- Warm & Hold will maintain the oven temperature at 170° F (77°C) for 3 hours.
- Warm & Hold may be set when finished cooking or may be added to automatically turn on after cooking using Cook Time. Delay Start may also be added.

**To add Warm & Hold to automatically turn ON after baking 45 minutes with default oven set temperature of 450 °F:**

1. Press **Cook Time**.
2. Enter **4 5** using numeric keypad.
3. Press **BAKE**.
4. On the numeric keypad, press 450.
5. Press  to accept.
6. Press **Warm & Hold**. **Hld** will appear in the display.
7. Press  to accept. When the cook time is over, the Warm & Hold will automatically turn on. The Warm & Hold function will automatically turn off after 3 hours.

### Setting Broil

Use the Broil function to cook meats that require direct exposure to radiant heat for optimum browning results. The Broil feature is factory preset to broil at 550°F. The Broil function temperature may be set at any temperature between 400°F (205°C) and 550°F (288°C).

The suggested broil settings are recommendations only (See Table 2). Depending on cooking preferences, you can increase or decrease cooking times or move food to a different rack position. If the food you are broiling is not listed in Table 2, follow the instructions provided in your cookbook and watch the item closely.



**⚠ WARNING** Should an oven fire occur, close the oven door and turn the oven off. If the fire continues, use a fire extinguisher. Do not put water or flour on the fire. Flour may be explosive.

**⚠ CAUTION** Always use pot holders or oven mitts when using the oven. When cooking, the oven interior, exterior, and oven racks will become very hot which can cause burns.

**Important note:**

- Always arrange oven racks when oven is cool.
- For best results when broiling, use quality broil pan along with a broil pan insert. A broil pan is designed to drain the fat from food, helping to reduce smoking and avoid splatter.
- When broiling, always pull the oven rack out to the stop position before turning or removing food. Cook Time or Delay Start will not operate with the Broil.

**To set Broil with the default broil oven temperature of 550°F:**

1. Arrange the oven racks when cool. For optimum browning results, preheat oven for 2 minutes before adding food.
2. Position bakeware in oven.
3. Press **Broil**.
4. Press .
5. Broil one side until food is browned; turn and broil other side until done to your satisfaction.
6. When finished, press .
7. To cancel Broil at any time, press .

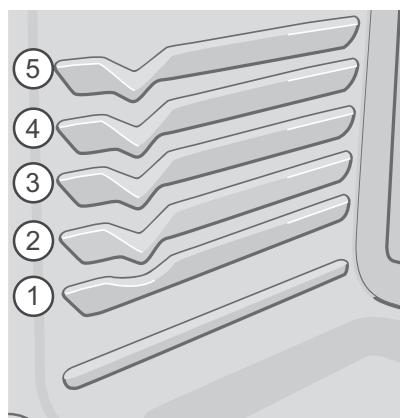

Figure 17: Broil positions

Table 2: Suggested broil settings (electric oven)

Food	Rack Position	Setting	Cook Time in minutes		Doneness
			1st side	2nd side	
Steak 1" thick	4th or 5th	550°F	6	4	Medium
Steak 1" thick	4th or 5th	550°F	7	5	Medium-well
Steak 1" thick	4th or 5th	550°F	8	7	Well
Pork chops 3/4" thick	4th	550°F	8	6	Well
Chicken (bone in)	3th	450°F	20	10	Well
Chicken (boneless)	4th	450°F	8	6	Well
Fish	4th	550°F	- as directed - - as directed -		Well
Shrimp	3th	550°F			Well
Hamburger 1" thick	5th*	550°F	9	7	Medium
Hamburger 1" thick	4th	550°F	10	8	Well

\* Use the off-set rack only in rack position 5, if an off-set rack is provided.

**Important note:** A broiler pan and insert are not supplied with this appliance. To purchase them, call Sears at 1-800-4-MY-

HOME (1-800-469-4663) and order broiler pan kit 5304442087.

## Oven Controls

### Adjusting Oven Temperatures

Your appliance has been factory calibrated and tested to ensure accurate baking temperatures. For the first few uses, follow your recipe times and temperature recommendations carefully. If you think the oven is cooking too hot or too cool for your recipe times, you may adjust the control so the oven cooks hotter or cooler than the oven temperature displayed.

The oven temperature may be increased as much as +35°F (+19°C) or decreased -35°F (-19°C) from the factory calibrated settings.

#### To increase (+) or decrease (-) the oven temperature by 20°F:

1. Press and hold **Bake** until the control produces an audible tone (about 6 seconds). The factory offset temperature of 0 (zero) should appear in the display.
2. Enter **2 0** using numeric keypad.
3. Press **Self Clean** to toggle between plus (+) if increasing temperature or minus (-) if decreasing the temperature.
4. Press  to accept change.

#### Important note:

- Oven temperature adjustments made will not change the Broil or Self Clean function temperatures.
- If the temperature shows an adjustment of -20°F, and a +20°F adjustment is needed, you can toggle between the minus (-) or plus (+) in the display when pressing **Self Clean** key (See Step 3).
- Do not use oven thermometers such as those found in grocery stores to check the temperature settings inside your oven. These oven thermometers may vary as much as 20°F to 40°F degrees from actual temperatures.
- The oven temperature adjustment may be made if your oven control has been set to display °C temperatures. Minimum and maximum settings for °C range from plus (+) 19°C to minus (-) 19°C.

### Restoring Factory Default Settings

When new, your appliance left the factory with predetermined (default) oven control settings. Over time, users may have made changes to these settings. The following options may have been modified since the appliance was new:

- 12 or 24 hour display mode
- Continuous bake or 12 hour energy savings mode
- Silent or audible control
- Oven temperature display (°F or °C)
- Oven temperature adjustments

#### To restore oven control to factory default settings:

**⚠ CAUTION** If you choose to restore factory default setting using this method, all of the above user settings will be restored to the factory default settings. This includes the oven temperature offset that will reset to (0) zero.

1. Press and hold **7** until acceptance tone sounds (about 6 seconds).
2. Press . The control has been reset with the default settings.

### Operating Oven Lights

The interior oven lights will automatically turn on when the oven door is opened.

Press  to turn the interior oven lights on and off whenever the oven door is closed. The oven light will not operate during a self-clean cycle.

The interior oven lights are located on the rear wall of the oven interior and are covered with a glass shield. The glass shield protects the bulb from high temperatures and should always be in place whenever the oven is in use.

To replace the interior oven light, see [“Replacing the oven light”](#) on page [page 21](#).

## Setting the Sabbath Feature (for use on the Jewish Sabbath and Holidays)





For further assistance, guidelines for proper usage, and a complete list of models with the Sabbath feature, please visit the web at: [star-k.org](http://star-k.org)

This appliance provides special settings for use when observing the Jewish Sabbath/Holidays. Sabbath mode disables all audible tones or visual display changes on the oven control. Bake heating is the only cooking feature available while in the Sabbath mode.

You must first set the Bake feature and temperature(s) needed for the oven, the Cook Time and Delay Start options (if needed), before setting the Sabbath mode. Any settings made prior to setting the Sabbath mode will be visible in the displays. The Cook Time option, if set prior to the Sabbath mode, will give one audible alert at the end of Cook Time.

The Sabbath mode will override the factory preset 12 hour energy saving mode, and the appliance will stay on until the cooking features are cancelled. If any of the cooking features are cancelled when the appliance is in the Sabbath mode, no audible or visual indicators will be available to verify the cancellation.

If the oven light is needed during the Sabbath, press  to turn the oven light on before activating the Sabbath feature. Once the oven light is turned on and the Sabbath feature is active, the oven light will remain on until the Sabbath feature is turned off. If the oven light needs to be off, be sure to turn the oven light off before activating the Sabbath feature.

It is recommended that any oven temperature change with the Sabbath feature active be followed with two presses of . This will ensure the oven remains on even if the attempt to set the oven temperature was lower or higher than the oven control can accept. If the oven temperature is set incorrectly, the oven temperature will default to 170°F or 550°F. Try to set the desired oven temperature again.

**⚠ WARNING** Food Poisoning Hazard. Do not let food sit for more than one hour before or after cooking. Doing so can result in food poisoning or sickness. Foods that can easily spoil such as milk, eggs, fish, meat, or poultry should be chilled in the refrigerator first. Even when chilled, they should not stand in the oven for more than 1 hour before cooking begins and should be removed promptly when finished cooking.

To program oven to Bake with default oven temperature of 350°F and activate the Sabbath feature:





1. Be sure the clock is set with the correct time of day.
2. Arrange oven racks, place bakeware in oven, and close oven door.
3. Press the **Bake** key.
4. Press .
5. If Cook Time or Delay Start are not needed, skip this step and continue to Step 6. If a Cook Time or Delay Start are desired, enter the times at this point. Refer to the “[Setting Cook Time](#)” and “[Setting Delay Start](#)” sections on [page 11](#) for detailed instructions.
6. Press and hold both **Cook Time** and **Delay Start** simultaneously for about 3 seconds to set the Sabbath feature. Once the feature is set, **SAb** will appear in the display indicating the oven is properly set for the Sabbath feature (See [Figure 18](#)).



Figure 18: SAb

### Important note:

- It is not advised to attempt to activate any other oven function except Bake while the Sabbath feature is active. Only the following keys will function correctly when the Sabbath feature is active: 0-9 number keypads, Bake, , and . All other keys should not be used once the Sabbath feature is active.
- You may change the oven temperature once baking has started. Press the **Bake** key, use the numeric keypad to enter the oven temperature change (170 to 550°F), and press  (for Jewish Holidays only). Remember that the oven control will no longer provide audible tones or display any further changes when the Sabbath feature is active.
- Remember the oven will shut-off automatically after completing a Cook Time, Delay Start, or Warm & Hold. Therefore, it may only be used once during the Sabbath/Jewish holidays.
- If a Delay Start time longer than the default 11 hours and 59 minutes is desired, set the oven control for the 24 hour day display mode setting. For detailed instructions, see “[Setting 12 or 24 Hour Display Mode](#)” on [page 9](#).

## Oven Controls

**To turn the oven off and keep the Sabbath feature active:**

Press .

**To turn off the Sabbath feature:**

Press and hold both **Cook Time** and **Delay Start** keys simultaneously for at least 3 seconds to turn the Sabbath feature off. The control will provide an acceptance tone, and SAb will disappear from the display. The oven is no longer programmed for the Sabbath feature.

**What to do during a power failure or power interruption after the Sabbath feature has been activated:**

Should you experience a power failure or interruption, the oven will shut-off. When power is restored the oven will not turn back on automatically. The oven will remember that it is set for the Sabbath, and the oven display will show the message **SF** for Sabbath failure (See [Figure 19](#)).



**Figure 19: SF**

The food may be safely removed from the oven while still in the Sabbath feature, however the oven cannot be turned back on until after the Sabbath/holidays. After the Sabbath observance turn off the Sabbath feature. Press and hold both **Cook Time** and **Delay Start** keys for at least 3 seconds simultaneously to turn the Sabbath feature off. **SF** will disappear from the display, and the oven may be used with all normal functions.



## Self Clean

A self cleaning oven cleans with very high temperatures well above normal cooking temperatures. The high temperature eliminates soils completely or reduces them to a fine powdered ash you can wipe away afterwards with a damp cloth.

The Self Clean function allows you to set a cleaning time from 2 hours to 4 hours. A 3 hour cleaning time is recommended for normal cleaning, 2 hours for light cleaning, and 4 hours for heavy cleaning.

### Read Before Starting Self Clean:

**⚠ CAUTION** Do not leave small children unattended near the appliance. During the self cleaning cycle, the outside of the oven can become very hot to touch and can cause burns.

**⚠ CAUTION** Do not line the oven walls, racks, bottom, or any other part of the oven with aluminum foil. Doing so will destroy heat distribution, produce poor baking results, and cause permanent damage to the oven interior. Aluminum foil will melt to the interior of the oven.

**⚠ CAUTION** The health of some birds is extremely sensitive to the fumes given off during the self cleaning cycle of any oven. Move birds to another well-ventilated room.

**⚠ CAUTION** Do not force the door open. This can damage the automatic door locking system. Use caution when opening the oven door after self cleaning. The oven may still be very hot and can cause burns. To avoid possible burns, stand to the side of the oven when opening the oven door to allow hot air or steam to escape.

### Important note:

Completely remove all oven racks and any accessories from oven cavity to avoid damage to oven racks. If the oven racks are not removed, they may discolor.

- Remove all items from the oven, including bakeware, utensils, and any aluminum foil. Aluminum foil will not withstand high temperatures from a self clean cycle and will melt.
- Do not use oven cleaners or oven protective coatings in or around any part of the oven interior.
- Clean any soil from the oven frame, the door liner outside the oven door gasket, and the small area at the front center of the oven bottom (See [Figure 20](#)). These areas heat sufficiently to burn soil on. Clean using soap and water prior to starting Self Clean.
- Remove any excessive build up caused by spills. Any spill on the oven bottom should be wiped-up and removed before starting a self clean cycle. To clean, use hot, soapy water and a cloth. Large spill residue can cause heavy smoke or fire when subjected to high temperatures. Do not allow food spills with a high sugar or acid content (such as milk,

tomatoes, sauerkraut, fruit juices, or pie filling) to remain on the surface because they may leave a dull spot even after cleaning.

- Do not clean the oven door gasket (See [Figure 20](#)). The woven material of the oven door gasket is essential for a good seal. Care should be taken not to rub, damage, or remove the gasket. Do not use any cleaning materials on the oven door gasket. Doing so could cause damage to the door gasket.

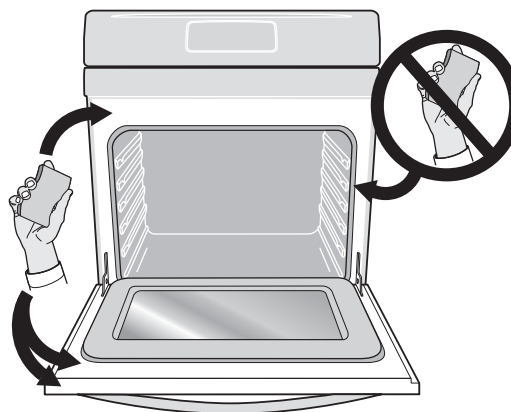

**Figure 20: Oven door area to clean and not clean (gasket).**

### To set Self Clean:

1. Be sure the oven is empty and all oven racks are removed. Remove all items from the oven. Be sure oven door is completely closed.
2. Press **Self Clean**, and the default 3 hour clean time will appear in the display. You may accept the default 3 hour clean time by going to Step 3 or choose a different clean time. Press **Self Clean** and use the numeric keypad to select any time between 2 hours and 4 hours. Once you have the desired clean time selected, proceed to Step 3.
3. Press  to activate Self Clean.

As soon as Self Clean becomes active, a motor driven lock mechanism will begin locking the oven door automatically. **door Loc** will appear in the display (See [Figure 21](#)). Do not open the oven door when **door Loc** is displayed (allow 15 seconds for the lock mechanism to lock the oven).

Once the oven door has locked, **CLn** will appear in the display, indicating Self Clean has started.



**Figure 21: Door locking (L) and active Clean (R)**

## Oven Controls



Figure 22: Hot (L) and door OPn (R)

### When Self Clean is Finished

1. The **Cln** message will turn off, and **Hot** will appear in display window (See [Figure 22](#)).
2. Once the oven has cooled down (about 1 hour) and **Hot** is no longer displayed, the **door OPn** message will appear. When this message turns off, the oven door may be opened.
3. When the oven interior has completely cooled, wipe away any residue or powdered ash with a damp cloth or paper towel.

**⚠ CAUTION** Use caution when opening the oven door after self cleaning. The oven may still be very hot and can cause burns. To avoid possible burns, stand to the side of the oven when opening the oven door to allow hot air or steam to escape.



### Important note:

The kitchen area should be well ventilated. Use an open window, ventilation fan, or exhaust hood during the first self clean cycle to help eliminate the normal odors associated with the initial self clean cycle.

When the clean time finishes, the oven door will remain locked until the oven has cooled sufficiently. In addition to the clean time that was programmed, allow about 1 additional hour for the oven to cool before opening the oven door. The Self Clean function will not operate when the oven lockout is active.

### Setting Delay Start Self Clean

To start a delay Self Clean with default clean time of 3 hours and a start time of 9:00 o'clock:

1. Be sure the clock is set with the correct time of day, the oven is empty, and all of the oven racks are removed. Be sure oven door is completely closed.
2. Press **Delay Start**.
3. Using numeric keypad, enter **9 0 0** for time to start.
4. Press  to accept.
5. Press **Self Clean**.
6. Press .

If it becomes necessary to stop Self Clean when active:

1. Press .
2. If Self Clean has heated the oven to a high temperature, allow enough time for the oven to cool and the **door OPn**

message to appear (See [Figure 22](#)). When this message turns off, the oven may be opened.

3. Before restarting Self Clean, be sure to read important notes below.

### Important note:

- When Self Clean is active, you may check the amount of clean time remaining by pressing the **Self Clean** key once.
- If your clock is set with the (default) 12 hr display mode, the Delay Start for a Self Clean can only be programmed to start up to 11 hours and 59 minutes after the time showing in the display (be sure to set the clock to current time before programming a delay start). To set a Delay Start Self Clean to begin 12 or more hours (maximum is 23 hours and 59 minutes) after the time of setting, be sure to first set the control in the 24 Hr display mode.
- If Self Clean was active and then interrupted by a power failure or cancelled before the oven was thoroughly cleaned, it may be necessary to run another Self Clean cycle.
- If the oven temperature was high enough when Self Clean was interrupted, the oven control may not allow another Self Clean cycle to be set for up to 4 hours.

# Care and Cleaning

---

## Cleaning Various Parts of Your Oven

Before cleaning any part of the oven, be sure all controls are turned off and the oven is cool. Remove spills and any heavy soiling as soon as possible. Regular cleaning will reduce the difficulty and time of major cleaning later.

---

Surface Type	Recommendation
Aluminum and Vinyl	Use hot, soapy water and a cloth. Dry with a clean cloth.
Painted body parts Painted decorative trims	Use a soft cloth and clean with mild dish detergent and water or a 50/50 solution of vinegar and water. Follow by rinsing the area with clean water; dry and polish with a soft cloth. Glass cleaners may be used if sprayed on a soft cloth first. Do not spray liquids directly on the oven control and display area. Do not use large amounts of water on the control panel. Excess water on the control area may cause damage to the appliance. Do not use other liquid cleaners, abrasive cleaners, scouring pads, or paper towels. They will damage the finish.
Easy Clean™ Stainless Steel (Some models)	Your oven finish may be Easy Clean™ Stainless Steel (some models). Clean the stainless with warm soapy water using a clean sponge or cloth. Rinse with clean water and dry with a soft clean cloth. Do not use any store bought cleaners like stainless steel cleaners or any other types of cleaners containing any abrasive, chlorides, chlorine, or ammonia. It is recommended to use mild dish soap and water or a 50/50 solution of water and vinegar.
Porcelain enamel broiler pan and insert Door liner and body parts	Gentle scouring with a soapy scouring pad will remove most spots. Rinse with a 1:1 solution of clear water and ammonia. If necessary, cover difficult spots with an ammonia-soaked paper towel for 30 to 40 minutes. Rinse with clean water and a damp cloth, and then scrub with a soap-filled scouring pad. Rinse and wipe dry with a clean cloth. Remove all cleaners or the porcelain may become damaged during future heating.
Oven racks	Oven racks must be removed from oven cavity. Clean by using a mild, abrasive cleaner following manufacturer's instructions. Rinse with clean water and dry.
Oven door	Use soap and water to thoroughly clean the top, sides, and front of the oven door. Rinse well. You may use a glass cleaner on the outside glass of the door. Do not immerse the door in water. Do not spray or allow water or the glass cleaner to enter the door vents. Do not use oven cleaners, cleaning powders, or any harsh abrasive cleaning materials on the outside of the oven door.  Do not clean the oven door gasket. On self-clean models, the oven door gasket is made of a woven material which is essential for a good seal. Care should be taken not to rub, damage, or remove this gasket.

---

## Removing and Replacing the Oven Door

**⚠ CAUTION** The door is heavy. For safe, temporary storage, lay the door flat with the inside of the door facing down.

### To remove the oven door:

1. Open oven door completely, horizontal with floor (See [Figure 23](#)).
2. Pull the door hinge locks on both left and right door hinges down from the oven frame completely toward the oven door (See [Figure 24](#)). A tool such as a small flat-blade screwdriver may be required.
3. Firmly grasp both sides of oven door along the door sides. Do not use the oven door handle (See [Figure 25](#)).
4. Close the door to approximately 10 degrees from the door frame (See [Figure 25](#)).
5. Lift the oven door hinge arms over the roller pins located on each side of the oven frame (See [Figure 25](#)).

### To Replace Oven Door:

1. Firmly grasp both sides of oven door along the door sides. Do not use the oven door handle (See [Figure 25](#)).
2. Holding the oven door at the same angle as the removal position, seat the hook of the hinge arm over the roller pins located on each side of the oven door frame (See [Figure 25](#) and [Figure 26](#)). The hook of the hinge arms must be fully seated onto the roller pins.
3. Fully open the oven door, horizontal with floor (See [Figure 23](#)).
4. Push the door hinge locks up toward and into the oven frame on both left and right oven door hinges to the locked position (See [Figure 24](#)).
5. Close the oven door.

### Important:

Special Door Care Instructions - Most oven doors contain glass that can break. Do not close the oven door until all the oven racks are fully in place. Do not hit the glass with pots, pans, or any other object. Scratching, hitting, jarring, or stressing the glass may weaken its structure causing an increased risk of breakage at a later time.

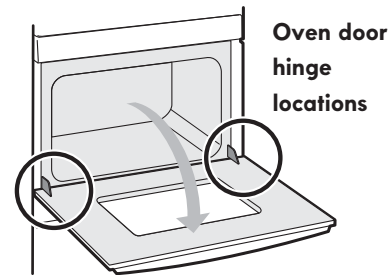

Figure 23: Door hinge location

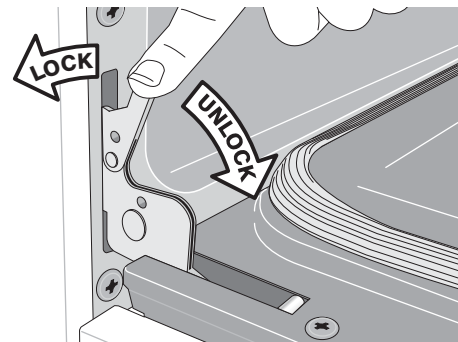

Figure 24: Door hinge locks

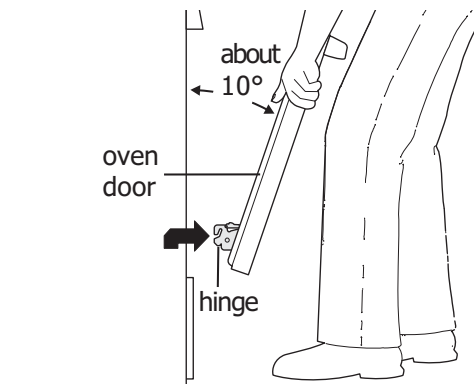

Figure 25: Holding door for removal

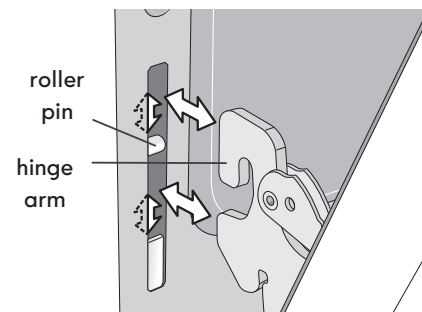

Figure 26: Replacement and location of hinge arm and roller pin

## Replacing the oven light

**⚠ CAUTION** Be sure the oven is unplugged and all parts are cool before replacing oven light.

The interior oven lights are located at the rear of the oven cavity and are covered with a glass shield. The glass shield must be in place whenever the oven is in use (See [Figure 27](#)).

### To replace the oven interior light bulb:

1. Turn electrical power off at the main source.
2. Remove interior oven light shield by turning a quarter turn counter-clockwise.
3. Replace bulb with a new T-4 type Halogen 25 watt appliance bulb.

### Important note:

Do not allow your fingers to touch the new bulb when replacing. This will shorten the life of the bulb. Use a paper towel or cotton glove while handling the new bulb when installing.

4. Replace glass oven light shield by rotating clockwise.
5. Turn power back on again at the main source (or plug the appliance back in).
6. Be sure to reset the time of day on the clock.

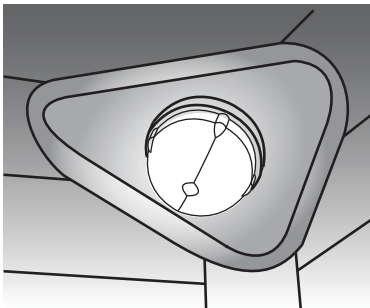

Figure 27: Wall oven Halogen light





# Before You Call

## Oven Baking

For best cooking results, heat the oven before baking cookies, breads, cakes, pies or pastries, etc. There is no need to preheat the oven for roasting meat or baking casseroles.

The cooking times and temperatures needed to bake a product may vary slightly from your previously owned appliance.

### Baking Problems and Solutions

Baking Problems	Causes	Corrections
Cookies and biscuits burn on the bottom. 	<ul style="list-style-type: none"> <li>• Cookies and biscuits put into oven before the preheating time is completed.</li> <li>• Oven rack is overcrowded.</li> <li>• Dark pans absorb heat too fast.</li> </ul>	<ul style="list-style-type: none"> <li>• Allow oven to preheat to desired temperature before placing food in oven.</li> <li>• Choose pan sizes that will permit 2" to 4" of air space (5.1 cm or 10.2 cm) on all sides when placed in the oven.</li> <li>• Use a medium weight baking sheet.</li> </ul>
Cakes too dark on top or bottom 	<ul style="list-style-type: none"> <li>• Cakes put in oven before preheating time is completed.</li> <li>• Rack position too high or too low.</li> <li>• Oven too hot.</li> </ul>	<ul style="list-style-type: none"> <li>• Allow oven to preheat to the selected temperature before placing food in the oven.</li> <li>• Use proper rack position for baking needs.</li> <li>• Set oven temperature 25°F (12°C) lower than recommended.</li> </ul>
Cakes not done in center 	<ul style="list-style-type: none"> <li>• Oven too hot.</li> <li>• Incorrect pan size.</li> <li>• Pan not centered in oven.</li> </ul>	<ul style="list-style-type: none"> <li>• Set oven temperature 25°F (12°C) lower than recommended.</li> <li>• Use pan size suggested in recipe.</li> <li>• Use proper rack position and place pan so there is 5.1 cm to 10.2 cm (2" to 4") of space on all sides of pan.</li> </ul>
Cakes not level. 	<ul style="list-style-type: none"> <li>• Oven not level.</li> <li>• Pan too close to oven wall or rack overcrowded.</li> <li>• Pan warped.</li> </ul>	<ul style="list-style-type: none"> <li>• Place a marked glass measuring cup filled with water on the center of the oven rack. If the water level is uneven, refer to the installation instructions for leveling the oven.</li> <li>• Be sure to allow 5.1 cm to 10.2 cm (2" to 4") of clearance on all sides of each pan in the oven.</li> <li>• Do not use pans that are dented or warped.</li> </ul>
Foods not done when cooking time is over. 	<ul style="list-style-type: none"> <li>• Oven too cool.</li> <li>• Oven overcrowded.</li> <li>• Oven door opened too frequently.</li> </ul>	<ul style="list-style-type: none"> <li>• Set oven temperature 25°F (12°C) higher than suggested and bake for the recommended time.</li> <li>• Be sure to remove all pans from the oven except the ones to be used for baking.</li> <li>• Open oven door only after shortest recommended baking time.</li> </ul>

---

## Solutions to Common Problems

Before you call for service, review the following list. It may save you time and expense. Possible solutions are provided with the problem listed:

Problem	Solution
Poor baking results	<ul style="list-style-type: none"> <li>• Many factors effect baking results. Use proper oven rack position. Center food in the oven and space pans to allow air to circulate. Preheat oven to the set temperature before placing food in the oven. Try adjusting the recipe's recommended temperature or baking time. See <a href="#">"Adjusting Oven Temperatures"</a> on <a href="#">page 14</a> if you feel the oven is too hot or cold.</li> </ul>
Oven does not operate.	<ul style="list-style-type: none"> <li>• The time of day is not set. The oven clock must first be set in order to operate the oven.</li> <li>• Be sure oven controls are set properly. See <a href="#">"Setting the Clock"</a> on <a href="#">page 9</a> and review instructions for the desired cooking function in this manual.</li> <li>• Service wiring is not complete.</li> </ul>
Oven light does not work.	<ul style="list-style-type: none"> <li>• Be sure the oven light is secure in the socket. See <a href="#">"Replacing the oven light"</a> on <a href="#">page 21</a>.</li> </ul>
Flames inside oven or smoking from oven vent.	<ul style="list-style-type: none"> <li>• Excessive spills in oven. Grease or food spilled onto oven bottom or oven cavity. Wipe up excessive spills before starting oven. If flames or excessive smoke are present when using broil, see <a href="#">"Setting Broil"</a> on <a href="#">page 13</a>.</li> </ul>
Self clean does not work.	<ul style="list-style-type: none"> <li>• Oven control not set properly. Review <a href="#">"Self Clean"</a> on <a href="#">page 17</a>.</li> </ul>
Oven racks discolored or do not slide easily.	<ul style="list-style-type: none"> <li>• Oven racks left in oven cavity during self clean. Always remove oven racks from oven cavity before starting a self-clean cycle. Clean using a mild abrasive cleaner following manufacturer's instructions. Rinse with clean water, dry, and replace in oven.</li> </ul>
Oven smokes excessively when broiling.	<ul style="list-style-type: none"> <li>• Incorrect setting. Follow broiling instructions in the <a href="#">"Setting Broil"</a> section on <a href="#">page 13</a>.</li> <li>• Meat too close to the broil element. Reposition broil rack to provide proper clearance between the meat and broil element. Remove excess fat from meat. Cut remaining fatty edges to prevent curling.</li> <li>• Grease build up on oven surfaces. Regular cleaning is necessary when broiling frequently. Grease or food splatters will cause excessive smoking.</li> </ul>
Oven control panel beeps and displays any F or E code error.	<ul style="list-style-type: none"> <li>• Oven control has detected a fault or error condition. Press <b>STOP</b> to clear the error code. Try bake or broil function. If the F or E code error repeats, turn off power to appliance, wait 5 minutes and then repower appliance. Set clock with correct time of day. Try bake or broil function again. If fault recurs, press <b>STOP</b> to clear.</li> </ul>
Soil not completely removed after self clean.	<ul style="list-style-type: none"> <li>• Self Clean was interrupted. Review <a href="#">"Self Clean"</a> on <a href="#">page 17</a>.</li> <li>• Excessive spills on oven bottom. Clean before starting self clean.</li> <li>• Failure to clean soil from the oven frame, the door liner outside the oven door gasket, and the small area at the front center of the oven bottom. These areas are not in the self-cleaning area, but they get hot enough to burn on residue. Clean these areas before starting the self-cleaning cycle. Burned-on residue can be cleaned with a stiff nylon brush and water or a nylon scrubber. Be careful not to damage the oven gasket.</li> </ul>

---

## Before You Call

### Master Protection Agreements

*Congratulations on making a smart purchase.* Your new Kenmore® product is designed and manufactured for years of dependable operation. But like all products, it may require preventive maintenance or repair from time to time. That's when having a Master Protection Agreement can save you money and aggravation.

The Master Protection Agreement also helps extend the life of your new product. Here's what the Agreement\* includes:

- ☑ **Parts and labor** needed to help keep products operating properly **under normal use**, not just defects. Our coverage goes **well beyond the product warranty**. No deductibles, no functional failure excluded from coverage – **real protection**.
- ☑ **Expert service** by a force of more than **10,000 authorized Sears service technicians**, which means someone you can trust will be working on your product.
- ☑ **Unlimited service calls and nationwide service**, as often as you want us, whenever you want us.
- ☑ **"No-lemon" guarantee** – replacement of your covered product if four or more product failures occur within twelve months.
- ☑ **Product replacement** if your covered product can't be fixed.
- ☑ **Annual Preventive Maintenance Check** at your request – no extra charge.
- ☑ **Fast help by phone** – we call it **Rapid Resolution** – phone support from a Sears representative on all products. Think of us as a "talking owner's manual".
- ☑ **Power surge protection** against electrical damage due to power fluctuations.
- ☑ **\$250 Food Loss Protection** annually for any food spoilage that is the result of mechanical failure of any covered refrigerator or freezer.
- ☑ **Rental reimbursement** if repair of your covered product takes longer than promised.
- ☑ **10% discount** off the regular price of any non-covered repair service and related installed parts.

Once you purchase the Agreement, a simple phone call is all that it takes for you to schedule service. You can call anytime day or night, or schedule a service appointment online.

The Master Protection Agreement is a risk free purchase. If you cancel for any reason during the product warranty period, we will provide a full refund. Or, a prorated refund anytime after the product warranty period expires. Purchase your Master Protection Agreement today!

**Some limitations and exclusions apply. For prices and additional information in the U.S.A. call 1-800-827-6655.**

**\* Coverage in Canada varies on some items. For full details call Sears Canada at 1-800-361-6665.**

### Sears Installation Service

*For Sears professional installation* of home appliances, garage door openers, water heaters, and other major home items, in the U.S.A. or Canada call **1-800-4-MY-HOME®**.

### Acuerdos maestros de protección

*Enhorabuena por haber hecho una compra inteligente.* Su nuevo producto Kenmore® está diseñado y fabricado para brindarle años de funcionamiento fiable. Pero, como cualquier producto, puede necesitar mantenimiento preventivo o reparaciones periódicas. Es por eso que tener un Acuerdo maestro de protección podría ahorrarle dinero y molestias.

El Acuerdo maestro de protección también sirve para prolongar la durabilidad de su nuevo producto. El acuerdo\* incluye lo siguiente:

- ☑ **Piezas y mano de obra** necesarias para contribuir a mantener el funcionamiento adecuado de los productos **utilizados en condiciones normales de uso**, no sólo en caso de defectos de los productos. Nuestra cobertura va **mucho más allá que la garantía del producto**. No se aplican deducibles ni exclusiones por fallas del funcionamiento: es decir, **verdadera protección**.
- ☑ **Servicio técnico por expertos** (más de **10000 técnicos autorizados de Sears**), lo cual significa que quien repare o realice el mantenimiento de su producto será un profesional de confianza.
- ☑ **Servicio técnico a escala nacional y número ilimitado de llamadas de solicitud de servicio técnico**: se puede poner en contacto con nosotros cuantas veces lo desee y cuando lo desee.
- ☑ **Garantía "sin sorpresas"**: se reemplaza el producto cubierto por el acuerdo si ocurren cuatro o más fallas del producto en un periodo de 12 meses.
- ☑ **Reemplazo del producto**: en caso de que no se pueda reparar el producto cubierto por el acuerdo.
- ☑ **Revisión anual preventiva de mantenimiento del producto**: puede solicitarla en cualquier momento, sin costo alguno.
- ☑ **Rápida asistencia telefónica**, la cual denominamos **Solución rápida**: es decir, asistencia telefónica a través de cualquiera de nuestros representantes de Sears, sobre cualquiera de nuestros productos. Piense en nosotros como en un "manual parlante del usuario".
- ☑ **Protección contra fallas eléctricas**, contra daños debidos a fluctuaciones de la corriente eléctrica.
- ☑ **\$250 al año para cubrir cualquier posible deterioro de alimentos** que haya tenido que desechar debido a una falla mecánica de cualquiera de nuestros refrigeradores o congeladores cubiertos por este acuerdo.
- ☑ **Devolución de gastos de alquiler de electrodomésticos** si la reparación de su producto asegurado toma más que el tiempo prometido.
- ☑ **10% de descuento** aplicable tanto a los costos del servicio de reparación, como de las piezas instaladas relacionadas que no hayan quedado cubiertos por este acuerdo.

Una vez que haya realizado el pago de este acuerdo, bastará una simple llamada telefónica para concertar una visita de servicio. Puede llamar a cualquier hora del día o de la noche, o bien concertar una visita de servicio por Internet.

La adquisición del Acuerdo maestro de protección es una inversión exenta de riesgos. Si por cualquier motivo decide cancelar dicho acuerdo durante el periodo de garantía del producto, le haremos un reintegro total del valor. O bien un importe proporcional si cancela el acuerdo en cualquier otro momento posterior al vencimiento del periodo de garantía del producto. ¡Adquiera hoy mismo su Acuerdo maestro de protección!

**Algunas limitaciones y exclusiones podrían aplicarse. Para solicitar precios e información adicional, llame al 1-800-827-6655 (en los EE.UU.).**

**\* La cobertura en Canadá varía en el caso de algunos artículos. Para obtener detalles completos al respecto, llame al 1-800-361-6665 de Sears de Canadá.**

### Servicio de instalación de Sears

*Para solicitar la instalación por profesionales de Sears* de electrodomésticos, abridores de puertas de garaje, calentadores de agua y otros artículos de uso prioritario en el hogar, **llame al 1-800-4-MY-HOME** en los EE.UU. o Canadá.



# Get it fixed, at your home or ours!

## Your Home

For troubleshooting, product manuals and expert advice:



[www.managemylife.com](http://www.managemylife.com)

For repair – **in your home** – of **all** major brand appliances, lawn and garden equipment, or heating and cooling systems, **no matter who made it, no matter who sold it!**

For the replacement parts, accessories and owner's manuals that you need to do-it-yourself.

For Sears professional installation of home appliances and items like garage door openers and water heaters.

**1-800-4-MY-HOME<sup>®</sup>** (1-800-469-4663)

Call anytime, day or night (U.S.A. and Canada)

[www.sears.com](http://www.sears.com)    [www.sears.ca](http://www.sears.ca)

## Our Home

For repair of carry-in items like vacuums, lawn equipment, and electronics, call anytime for the location of your nearest

**Sears Parts & Repair Service Center**

**1-800-488-1222** (U.S.A.)    **1-800-469-4663** (Canada)

[www.sears.com](http://www.sears.com)    [www.sears.ca](http://www.sears.ca)

To purchase a protection agreement on a product serviced by Sears:

**1-800-827-6655** (U.S.A.)    **1-800-361-6665** (Canada)

Para pedir servicio de reparación a domicilio, y para ordenar piezas:

**1-888-SU-HOGAR<sup>®</sup>**

(1-888-784-6427)

[www.sears.com](http://www.sears.com)

Au Canada pour service en français:

**1-800-LE-FOYER<sup>MC</sup>**

(1-800-533-6937)

[www.sears.ca](http://www.sears.ca)

The Sears logo, consisting of the word "sears" in a lowercase, serif font.

® Registered Trademark / <sup>TM</sup> Trademark of KCD IP, LLC in the United States, or Sears Brands, LLC in other countries

© Marca Registrada / <sup>TM</sup> Marca de Fábrica de KCD IP, LLC en Estados Unidos, o Sears Brands, LLC in otros países

<sup>MC</sup> Marque de commerce / <sup>MD</sup> Marque déposée de Sears Brands, LLC

## Free Manuals Download Website

<http://myh66.com>

<http://usermanuals.us>

<http://www.somanuals.com>

<http://www.4manuals.cc>

<http://www.manual-lib.com>

<http://www.404manual.com>

<http://www.luxmanual.com>

<http://aubethermostatmanual.com>

Golf course search by state

<http://golfingnear.com>

Email search by domain

<http://emailbydomain.com>

Auto manuals search

<http://auto.somanuals.com>

TV manuals search

<http://tv.somanuals.com>