

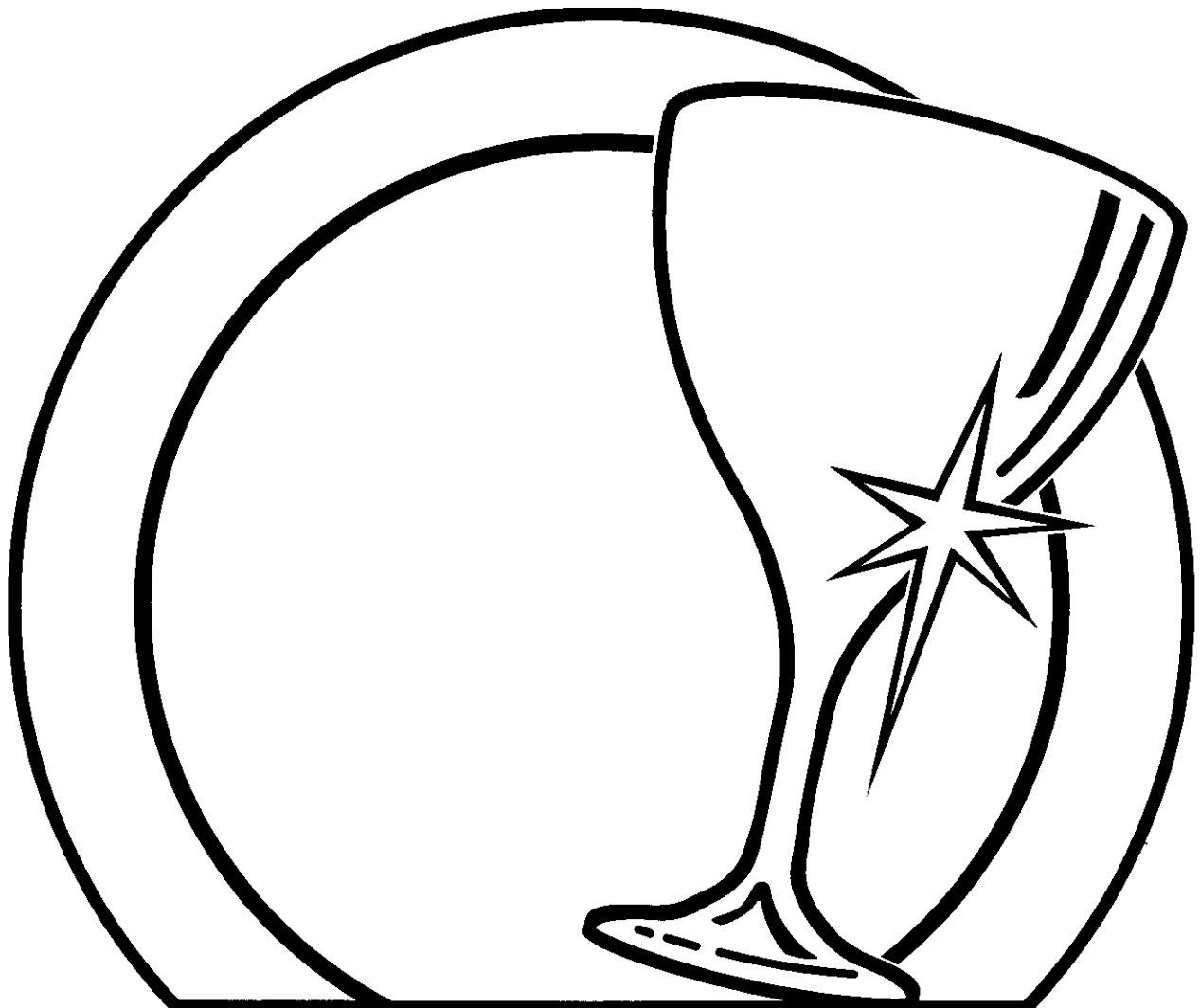

# Ultra Wash Dishwasher Use & Care Guide

Table of Contents ..... 1 (English section)



# Table of Contents

	Page		Page
<b>Sears Dishwasher Warranty</b> .....	1	<b>Your Part in Cleaning Dishes</b>	
<b>Dishwasher Safety</b> .....	2	Using the detergent dispenser .....	11
<b>Parts and Features</b> .....	3	Using the rinse agent dispenser .....	12
<b>America's Cleanest Dishes</b>		Water temperature tips .....	12
How the ULTRA WASH* System works .....	4	Cycles .....	13
<b>Start Up Guide</b>		Options .....	15
Before using your dishwasher .....	5	Status indicator lights .....	16
Starting your dishwasher for everyday loads .....	6	<b>Caring for Your Dishwasher</b>	
<b>Loading Your Dishwasher</b>		Cleaning your dishwasher .....	16
Preparing to load your dishwasher .....	7	Storing your dishwasher .....	17
Loading the top rack .....	7	Tips for washing special items .....	18
Loading the bottom rack .....	9	<b>Troubleshooting Guide</b> .....	19
Loading the silverware basket .....	10	<b>We Service What We Sell</b> .....	22
Quiet operating tips .....	10	<b>Sears Repair Services in U.S.A. and Canada</b> .....	23

## Sears Dishwasher Warranty

### FULL ONE YEAR WARRANTY ON KENMORE ULTRA WASH\* DISHWASHERS

For one year from the date of purchase, when the dishwasher is installed and operated in accordance with the instructions provided in the Installation Instructions and Owners Manual, Sears will repair, free of charge, defects in materials or workmanship.

### FULL WARRANTY FOR THE LIFE OF THE DISHWASHER ON ULTRA LIFE\* TUB MODELS AGAINST LEAKS IN THE TUB AND INNER DOOR PANEL

For the life of the dishwasher if a leak should occur as a result of failure of the polypropylene tub or inner door panel due to cracking, chipping or peeling, Sears will replace, free of charge, the tub or inner door panel.

### LIMITED TWO YEAR WARRANTY ON THE ULTRA WASH\* WASH SYSTEM

After the first year and until two years from the date of purchase, when the dishwasher is installed and operated in accordance with the instructions provided in the Installation Instructions and Owners Manual, Sears will furnish free of charge, replacement parts for any part of the ULTRA WASH wash system (motor, pump, spray arms, ULTRAFLOW\* water feed tube, motor seals, and pump gasket) which is defective in materials or workmanship. Customer assumes any labor costs associated with replacement of these parts.

If the dishwasher is subject to other than private family use, the above warranty coverage is effective for only 90 days.

WARRANTY SERVICE IS AVAILABLE BY CONTACTING THE NEAREST SEARS SERVICE CENTER IN THE UNITED STATES OR CANADA. This warranty applies only while the product is in use in the United States or Canada. This warranty gives you specific legal rights, and you may also have other rights which vary from state to state or province to province.

Sears, Roebuck and Co.  
Dept. 817WA, Hoffman Estates, IL 60179

3/97  
Sears Canada, Inc.  
Toronto, Ontario, Canada M5B2B8

\* Indicates symbol for Trademark

# Dishwasher Safety

## Your safety and the safety of others is very important.

We have provided many important safety messages in this manual and on your appliance. Always read and obey all safety messages.



This is the safety alert symbol.

This symbol alerts you to hazards that can kill or hurt you and others.

All safety messages will be preceded by the safety alert symbol and the word "DANGER" or "WARNING." These words mean:

**⚠ DANGER**

You will be killed or seriously injured if you don't follow instructions.

**⚠ WARNING**

You can be killed or seriously injured if you don't follow instructions.

All safety messages will identify the hazard, tell you how to reduce the chance of injury, and tell you what can happen if the instructions are not followed.

## IMPORTANT SAFETY INSTRUCTIONS

**WARNING** – When using the dishwasher, follow basic precautions, including the following:

- Read all instructions before using the dishwasher.
- Use the dishwasher only for its intended function.
- Use only detergents or rinse agents recommended for use in a dishwasher and keep them out of the reach of children.
- When loading items to be washed:
  - 1) Locate sharp items so that they are not likely to damage the door seal; and
  - 2) Load sharp knives with the handles up to reduce the risk of cut-type injuries.
- Do not wash plastic items unless they are marked "dishwasher safe" or the equivalent. For plastic items not so marked, check the manufacturer's recommendations.
- Do not touch the heating element during or immediately after use.
- Do not operate the dishwasher unless all enclosure panels are properly in place.
- Do not tamper with controls.
- Do not abuse, sit on, or stand on the door or dish racks of the dishwasher.
- To reduce the risk of injury, do not allow children to play in or on the dishwasher.
- Under certain conditions, hydrogen gas may be produced in a hot water system that has not been used for two weeks or more. **HYDROGEN GAS IS EXPLOSIVE.** If the hot water system has not been used for such a period, before using the dishwasher turn on all hot water faucets and let the water flow from each for several minutes. This will release any accumulated hydrogen gas. As the gas is flammable, do not smoke or use an open flame during this time.
- Remove the door to the washing compartment when removing an old dishwasher from service or discarding it.

**– SAVE THESE INSTRUCTIONS –**

# Parts and Features

Use this section to become familiar with the location and appearance of all parts and features. To help you find information on specific parts or features quickly, page references are included.

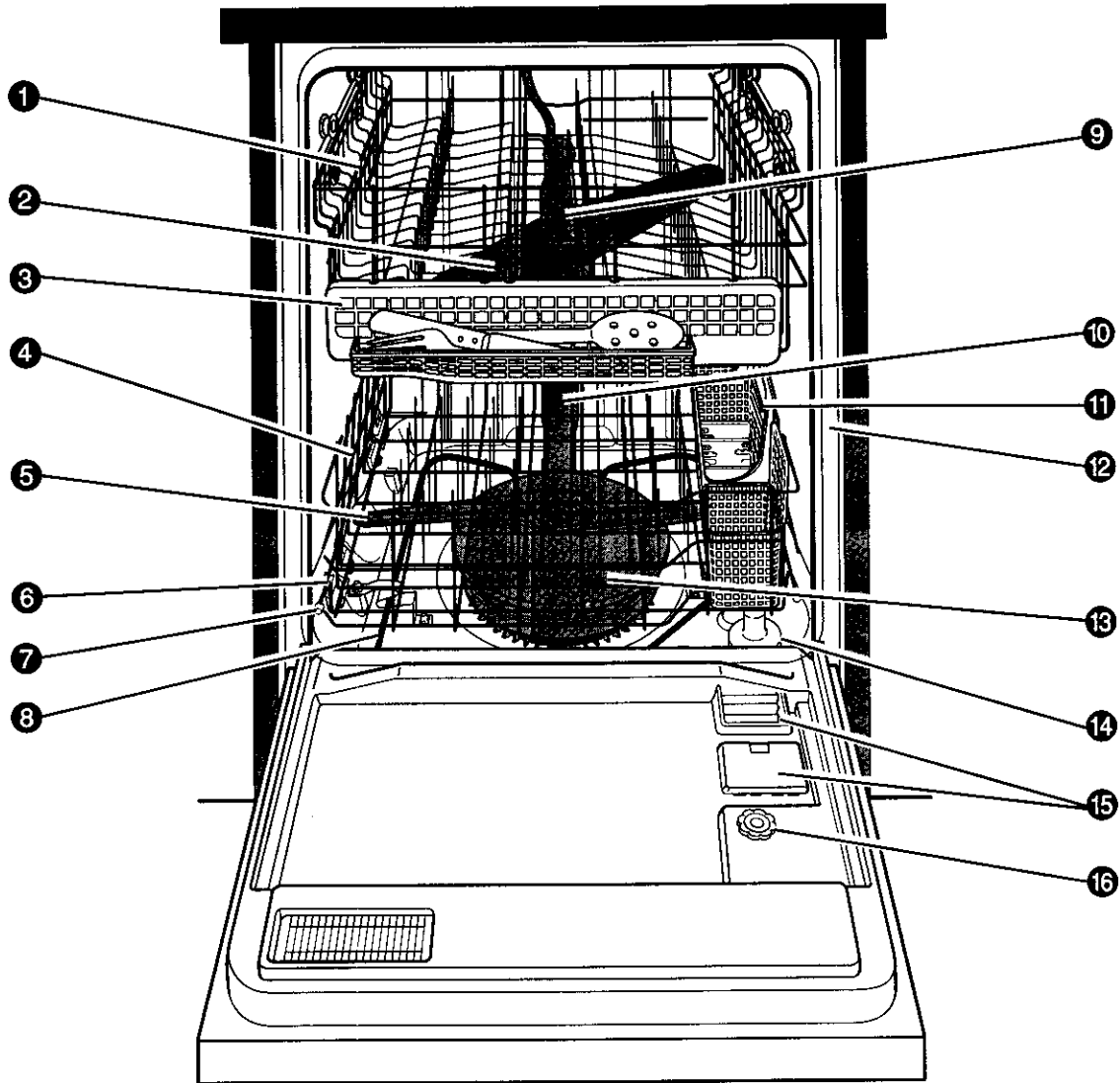

- |                                     |   |
|-------------------------------------|---|
| ① Top rack (pg. 7)                  | ⑨ Third level wash                              |
| ② Upper spray arm                   | ⑩ ULTRAFLOW* water feed tube                    |
| ③ Utensil basket (pg. 8)            | ⑪ Silverware basket (pg. 10)                    |
| ④ Bottom rack (pg. 9)               | ⑫ Model and serial number label (on right side) |
| ⑤ Lower spray arm                   | ⑬ ULTRA WASH* module (pg. 4)                    |
| ⑥ Water inlet opening [in tub wall] | ⑭ Overfill protector                            |
| ⑦ Rack bumper                       | ⑮ Detergent dispenser (pg. 11)                  |
| ⑧ Heating element                   | ⑯ Rinse agent dispenser (pg. 12)                |

## Additional features your dishwasher may have:

**NO-FLIP\* clip(s)** (pg. 8)

**Extra-capacity fold-down shelf** (pg. 8)

# America's Cleanest Dishes

## How the ULTRA WASH\* System works

Your dishwasher's new ULTRA WASH Soil Removal System is designed to give you sparkling clean dishes in the shortest amount of time with the least amount of energy necessary. The ULTRA WASH System includes a heavy duty grinder that acts as a food disposer to grind and dispose of large food particles.

### Here's how the ULTRA WASH Soil Removal System works:

1. When you load the dishwasher, all you need to do is remove bones, large chunks, or burned-on food. Any remaining food will be ground up and disposed.
2. Hot water fills the dishwasher to a level near the bottom of the overfill protector.
3. While the water is heated, the Water Heating indicator on the control panel glows.
4. Detergent is added at the correct times from the detergent dispenser, and hot water is pumped through the ULTRA WASH pump.
5. Food particles are removed from dishes, pots and pans, tableware, and cutlery as the dishwasher sprays a mixture of hot water and detergent through two spray arms against their soiled surfaces.
6. Food soil in the dishwasher is held in an accumulating chamber so it does not recirculate into the dishwasher.
7. Water is pumped again through the ULTRA WASH pump to remove soil particles from the water, and "hold" them in the accumulating chamber **A**.
8. Soil in the ULTRA WASH Soil Removal System is disposed down the drain with the wash water **B**.
9. Fresh, hot water enters the dishwasher, sprays on the dishes to rinse them, and the rinse water is pumped through the ULTRA WASH System to remove any remaining soil.
10. Soil that is held in the ULTRA WASH Soil Removal System is disposed down the drain with the rinse water.
11. Final rinse water is heated and a rinse agent is added to prepare the dishes for drying.

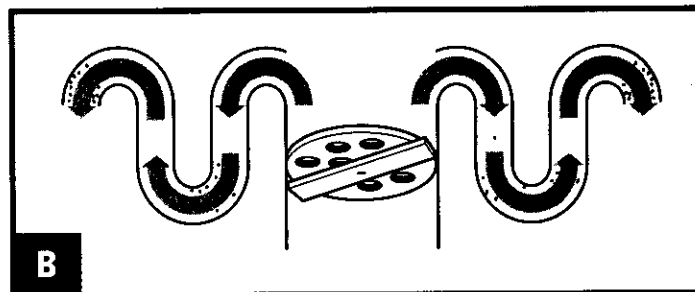
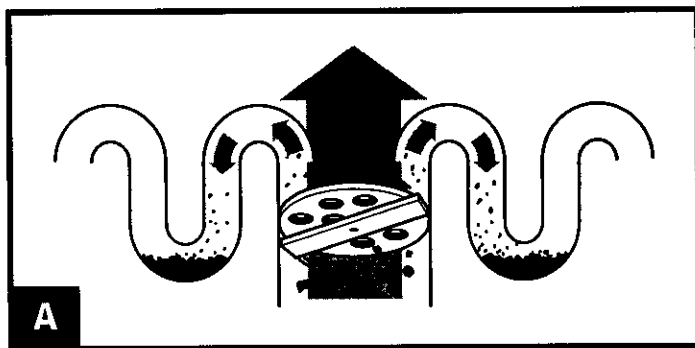

# Start Up Guide

## Before using your dishwasher

### ⚠ WARNING



#### Tip Over Hazard

Do not use dishwasher until completely installed.  
Do not push down on open door.  
Doing so can result in serious injury or cuts.

### ⚠ WARNING



#### Electrical Shock Hazard

Electrically ground dishwasher.  
Connect ground wire to green ground connector  
in terminal box.  
Do not use an extension cord.  
Failure to do so can result in death, fire, or  
electrical shock.

## GROUNDING INSTRUCTIONS

- For a grounded, cord connected dishwasher:  
The dishwasher must be grounded. In the event of a malfunction or breakdown, grounding will reduce the risk of electric shock by providing a path of least resistance for electric current. The dishwasher is equipped with a cord having an equipment-grounding conductor and a grounding plug. The plug must be plugged into an appropriate outlet that is installed and grounded in accordance with all local codes and ordinances.

**WARNING** – Improper connection of the equipment grounding conductor can result in a risk of

electric shock. Check with a qualified electrician or service representative if you are in doubt whether the dishwasher is properly grounded. Do not modify the plug provided with the dishwasher; if it will not fit the outlet, have a proper outlet installed by a qualified electrician.

- For a permanently connected dishwasher:  
The dishwasher must be connected to a grounded metal, permanent wiring system, or an equipment-grounding conductor must be run with the circuit conductors and connected to the equipment-grounding terminal or lead on the dishwasher.

– SAVE THESE INSTRUCTIONS –

# Starting your dishwasher for everyday loads

Here is an overview for loading and running your dishwasher. Refer to the noted pages for more details of each step.

1. The ULTRA WASH\* Soil Removal System is designed to remove food particles from the wash and rinse water. Remove only large chunks of food and bones from your dishes.
2. Properly load the dishwasher **A**. Make sure nothing prevents the spray arms from spinning freely **B**. See page 9.

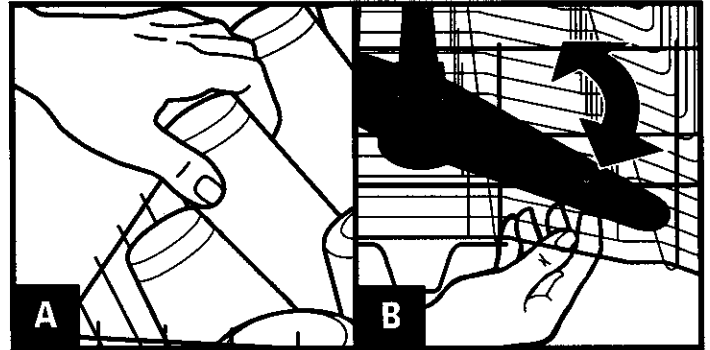

3. Add detergent **C** and check the rinse agent dispenser. Add rinse agent if needed **D**. See pages 11 and 12.

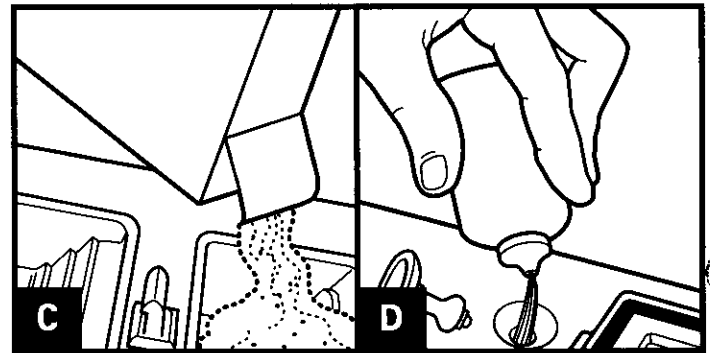

4. Push door firmly closed **E**. The door latches automatically. Run hot water at the sink nearest your dishwasher until water is hot **F**. Turn off water. See page 12.

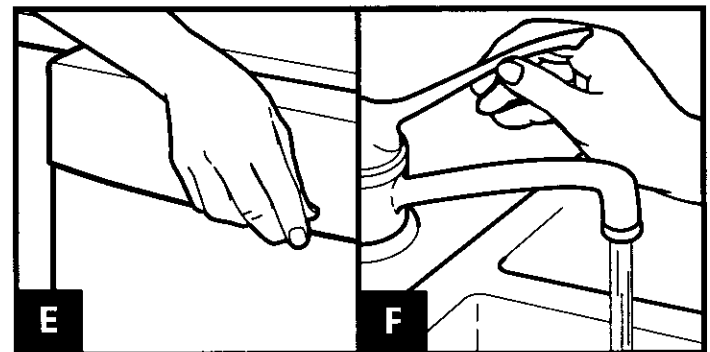

5. Press the desired Cycle and Options buttons **G**. Turn the Timer Knob to the desired Cycle to start **H**. See pages 13-15.

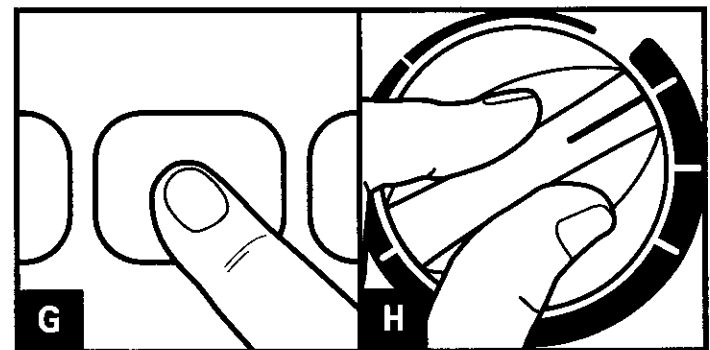

# Loading Your Dishwasher

This section tells you how to load your dishwasher properly for the best washing and rinsing results.

## Preparing to load your dishwasher

- Load correctly for best washing results. Incorrect loading may cause poor washing and the need to rewash all or part of the load.
- Wash full loads. Running a half-filled dishwasher uses the same amount of electricity and hot water as a fully loaded machine.
- To save water and energy, do not rinse dishes before putting them into the dishwasher.
- Remove large pieces of food, fruit pits, bones, and other hard items. The ULTRA WASH\* module will remove food particles from the water. The module contains a chopping device which will reduce the size of food items.

**NOTE:** If hard items such as fruit seeds, nuts, and egg shells enter the ULTRA WASH module, you might hear chopping, grinding, crunching, or buzzing sounds. Those

sounds are normal when hard items enter the module.

**Do not** let metallic items (such as pot handle screws) get into the ULTRA WASH module. They could damage the ULTRA WASH module.

- Foods like eggs, rice, pasta, spinach, and cooked cereals may be hard to remove if they are left to dry over a period of time. Run a Quick Rinse cycle to keep dishes moist if you do not plan to wash them soon.
- Load dishes so soiled surfaces face the rotating spray arms.
- Load dishes so they are not stacked or overlapping, if possible. It is important for the water spray to reach all soiled surfaces for best washing. For best drying, water must be able to drain from all surfaces.

## Loading the top rack

The top rack is designed for cups, glasses, and smaller items. See **A** & **B**.

- Place items so open ends face down for cleaning and draining.
- Load glasses in top rack only – bottom rack is not designed for glasses. Damage may occur.
- Place cups and glasses in the rows between prongs. Placing them over the prongs can lead to breakage.
- Secure lightweight items.
- China, crystal, and other delicate items must not touch each other during dishwasher operation. Damage may occur.
- Load plastic items in the top rack only. Only plastic items marked “dishwasher safe” are recommended.
- Load plastic items so the force of the spray does not move them during the cycle.
- To avoid chipping, do not let stemware touch other items.
- Small bowls, pans, and other utensils can be placed in the top rack.

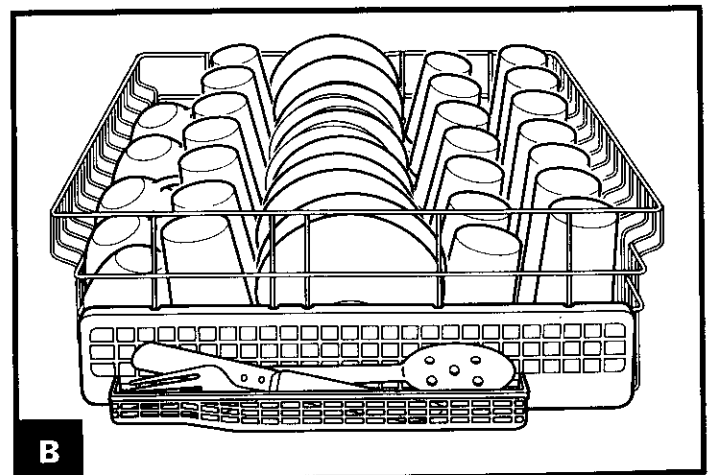
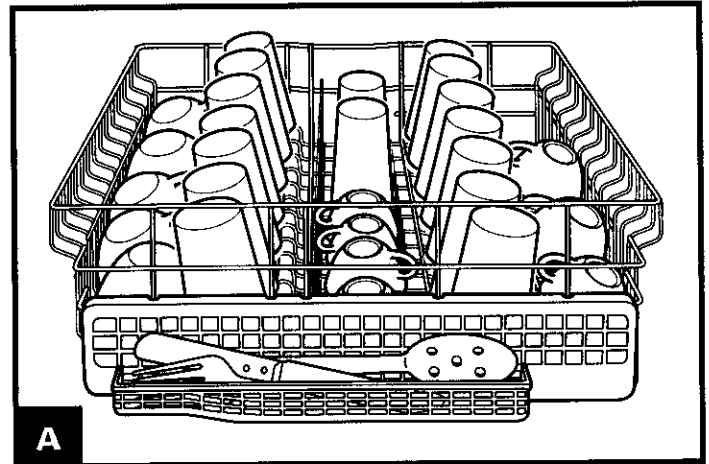



## Loading the top rack (cont.)

### Utensil basket

Use this extra capacity basket on the top rack to hold spatulas, wooden spoons, and similar items **A**.

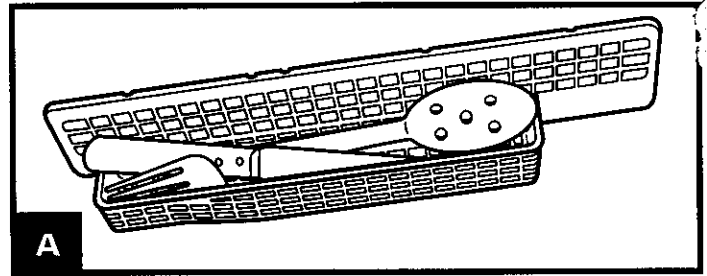

### Extra-capacity fold-down shelf (on some models)

Fold the extra shelf on the top rack down over short items (cups, juice glasses, cereal bowls, etc.) to make space for extra items **B**.

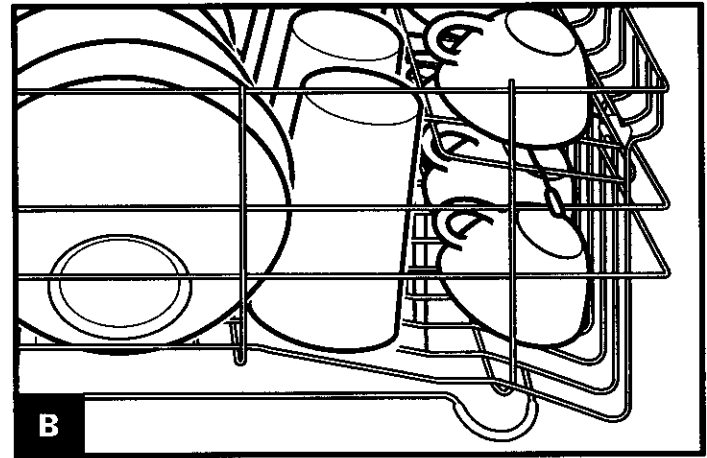

### NO-FLIP\* clip(s) (on some models)

Use the NO-FLIP clip(s) to hold small, lightweight items in place during the cycle **C**.

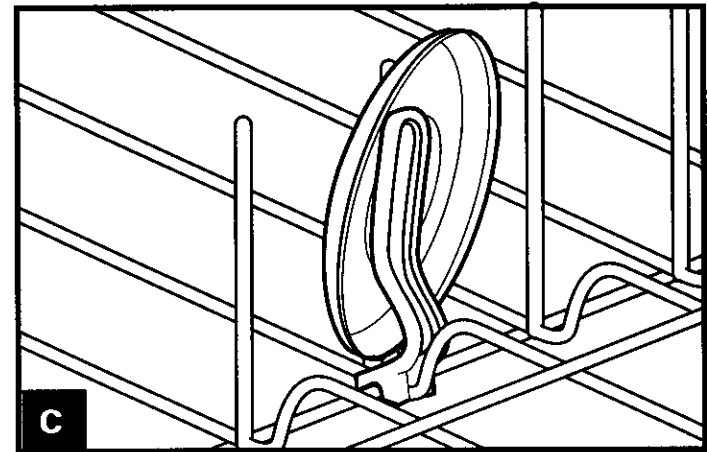

## Loading the bottom rack

Items with cooked-on or dried-on food should be loaded in the bottom rack, with soiled surfaces facing inward to the spray. See **A** & **B**.

- Do not load glasses, cups, or plastic items in the bottom rack.
- Load plates, soup bowls, etc., between prongs and facing inward to the spray.
- Overlap edges of plates for large loads.
- Secure heavily soiled cookware face down in the rack.
- Make sure pot handles and other items do not stop rotation of the upper or lower spray arm. The spray arm must move freely.

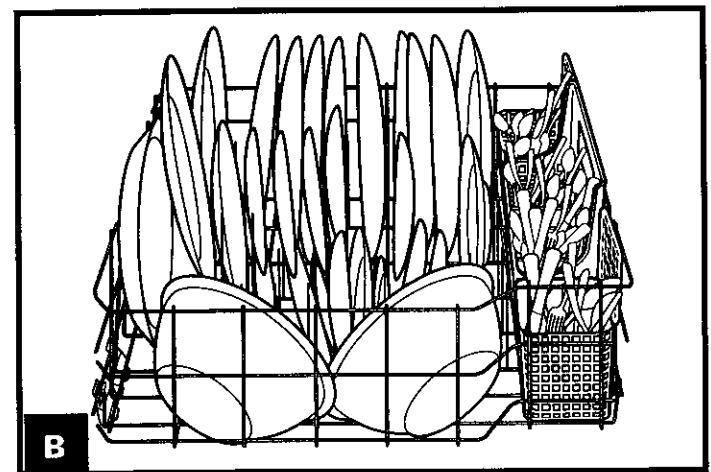
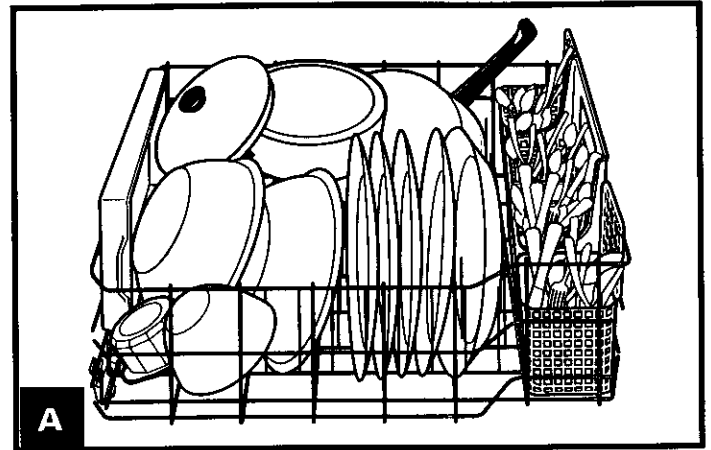

## Loading the silverware basket

- Load the silverware basket while it is in the bottom rack or take the basket out for loading on a counter or table.  
**NOTE:** You can remove the basket for easy unloading. Always unload or remove the basket before unloading the racks to avoid spilling water droplets on the silverware.
- Place small items (baby bottle caps, jar lids, etc.) in a section with a hinged cover. Close the cover over the section to hold small items in place **A**.

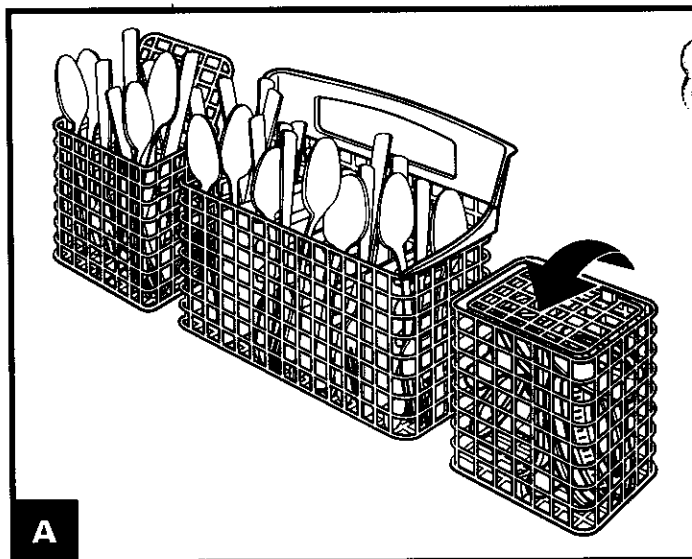

- You can separate the two small baskets from the large basket **B** and position the small baskets elsewhere in the upper or lower rack.

### To remove a small basket:

1. Hold the center basket with one hand, and one of the small baskets with the other hand.
2. Slide the small basket to release tabs from corresponding slots.
3. Pull baskets apart.

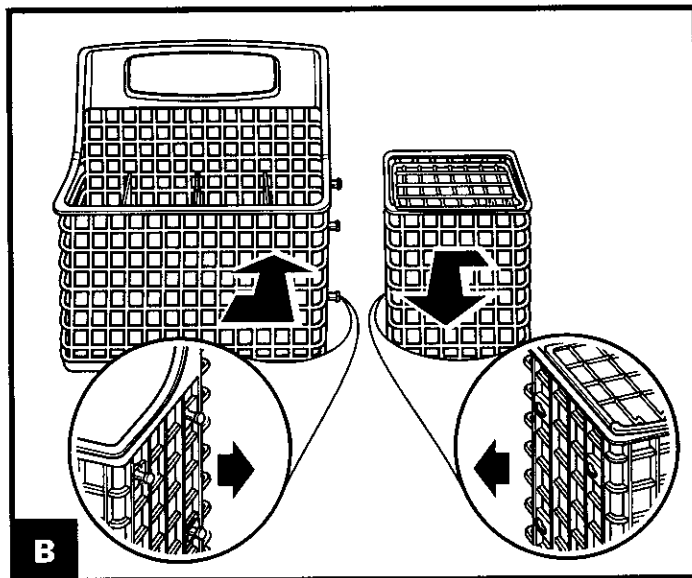

- Mix items in each section of the basket with some pointing up and some down to avoid nesting **C**. Spray cannot reach nested items.  
**IMPORTANT:** Always load sharp items (knives, skewers, forks, etc.) pointing down.

## Quiet operating tips

### To avoid thumping/clattering noises during operation:

- Make sure lightweight load items are secured in the racks.
- Make sure pot lids and handles, pizza pans, cookie sheets, etc., do not touch interior walls or interfere with the spray arm's rotation.
- Load dishes so they do not touch one another.

**NOTE:** Keep sink drain plugs closed during dishwasher operation to prevent noise transfer through drains.

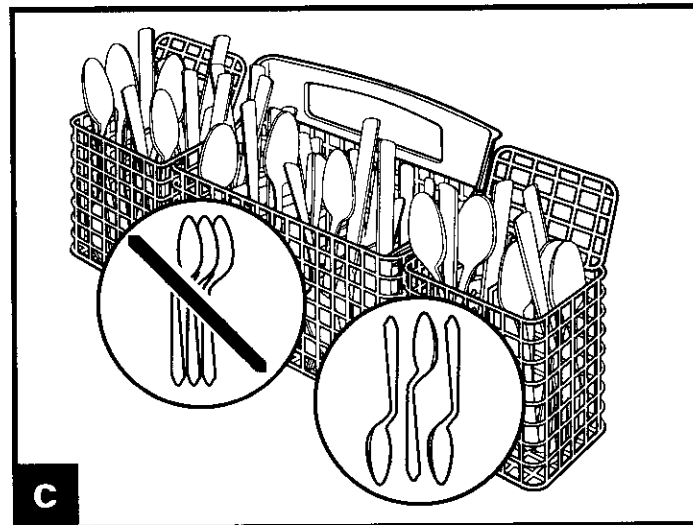

# Your Part in Cleaning Dishes

Operating your dishwasher properly enables you to obtain the best possible results. This section explains proper dishwasher operation.

## Using the detergent dispenser

- Use automatic dishwashing detergent only. Other detergents are too mild and much too sudsy.
- Add detergent just before starting cycle.
- Store tightly closed detergent in a cool, dry place. **Fresh automatic dishwasher detergent results in better cleaning.**

### Filling the detergent dispenser

The detergent dispenser **A** has one section with a cover and one without. Push the cover down firmly until it latches. Detergent in the open section falls into the dishwasher when closing the door. The covered section opens automatically for the main wash. It is normal for the cover to open partially when dispensing detergent.

**NOTE:** Use both sections for cycles with two washes. Use only the covered section for cycles with one wash. See the cycles chart for more details.

### How much detergent to use

- The amount of detergent to use depends on the hardness of your water and the type of detergent. If you use too little, dishes won't be clean. If you use too much in soft water, glassware will etch.
- Find out your water's hardness by asking the water softener department in your local Sears store or your local water department.

**NOTE:** Fill amounts shown are for standard powdered detergent. Amounts may vary if you use liquid or concentrated powdered detergent. Follow instructions on the package when using liquid dishwasher detergent or concentrated powdered detergent.

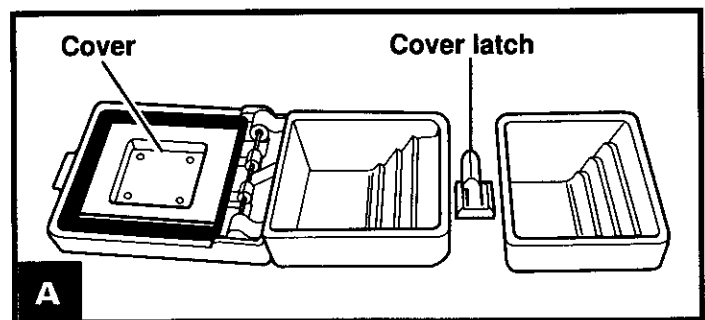

Water Type	Where to fill standard powdered detergent	
<b>Hard</b> 8+ grains per gallon 136+ parts per million	Top of 3rd step (3 tbs.)	
<b>Medium</b> 5-7 grains per gallon 85-119 parts per million	Top of 2nd step (2 tbs.)	
<b>Soft</b> 0-4 grains per gallon 0-68 parts per million	Top of 1st step (1 tbs.)	

## Using the rinse agent dispenser

A rinse agent greatly improves dish drying and helps prevent spots or streaks. The rinse agent helps water flow off dishes and keeps water from forming droplets. A small amount of rinse agent automatically releases into the final rinse water.

**Keep the rinse agent dispenser filled with a liquid rinse agent.** For best drying results, periodically check the dispenser as follows to see if it needs filling:

- Check center of rinse aid indicator cap **A**. Clear means it needs filling.

**OR**

- Remove rinse aid indicator cap. An "E" is visible at the bottom of the dispenser when empty **B**.

**To fill dispenser:**

1. Open dishwasher door completely.
2. Remove rinse aid indicator cap.
3. Add rinse agent **C**. Fill only to smallest opening in lower part of dispenser. Overfilling may cause rinse agent to leak out. This will not harm the dishwasher, but could cause oversudsing.
4. Clean up any spilled rinse agent with a damp cloth.
5. Replace rinse aid indicator cap. Keep it closed tightly.

**NOTES:**

- Your dishwasher is designed to use a liquid rinse agent. Do not use a solid or bar-type rinse agent.
- The rinse agent dispenser holds 6 ounces (175 mL). Under normal conditions, this lasts about 3 months.
- You do not have to wait until the dispenser is empty before refilling, but do not overfill it.

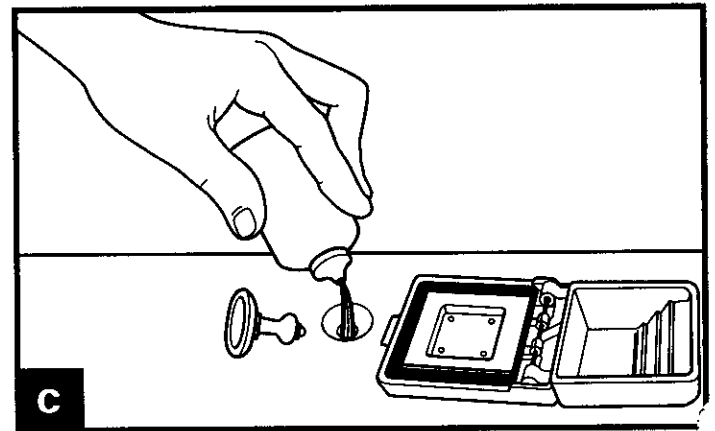
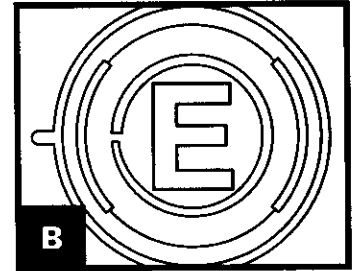
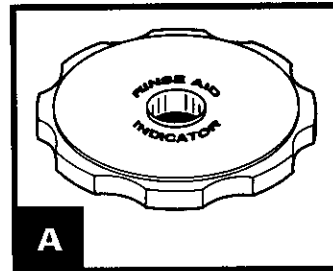

## Water temperature tips

Hot water dissolves and activates the dishwashing detergent. Hot water also dissolves grease on dishes and helps dry glasses spot-free. For best dishwashing results, water must be at least 120°F (49°C) as it enters the dishwasher. Loads may not wash as well if the water temperature is too low.

**NOTE:** Use the Water Heat option on your dishwasher if you keep your water heater at a low setting. The Timer Knob pauses and the Water Heating status indicator glows while water is heating. For more information, see "Dishwasher seems to run too long" in the "Troubleshooting Guide" section.



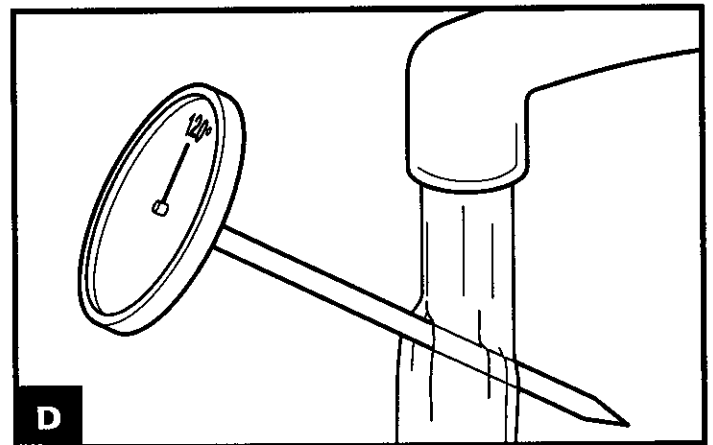

**To check water temperature:**

1. Run hot water at the faucet closest to your dishwasher for at least 1 minute.
2. Measure the water temperature with a candy or meat thermometer placed in the running stream of water **D**.
3. If the water temperature at the faucet is below 120°F (49°C), have a qualified person raise the water heater's thermostat setting.

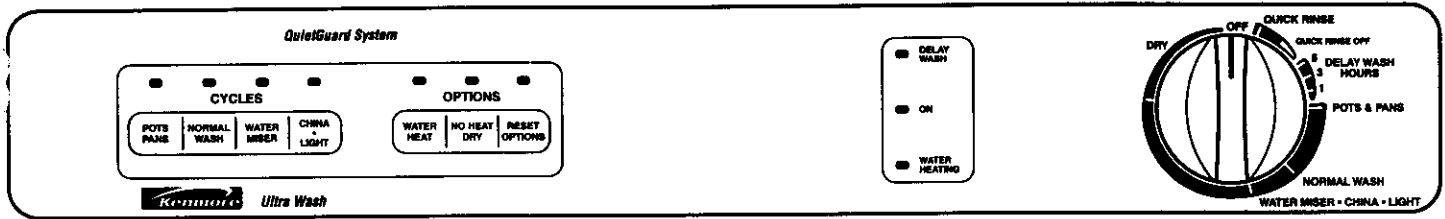

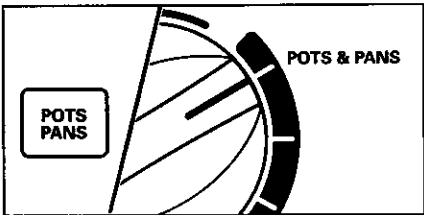
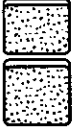
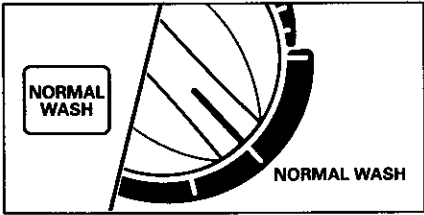
# Cycles

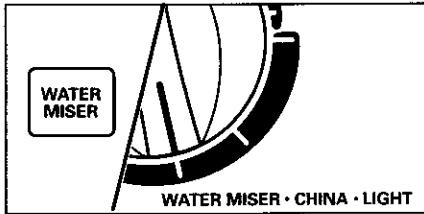

CYCLE	A "✓" shows what each cycle includes.					Cycle Time†† (min.)	Water Usage (gallons[U.S.]/ liters)	Detergent Dispenser Sections
	Wash	Rinse	Main Wash	Rinse	Dry			
<b>POTS &amp; PANS</b> 	✓†	✓	✓†	✓†	✓	88††	9.1/34.4	 Fill 2 Detergent cups
<b>NORMAL WASH</b> 	✓		✓†	✓†	✓	72††	6.9/26.1	 Fill 2 Detergent cups
<b>WATER MISER</b> 			✓†	✓†	✓	62††	4.8/18.2	 Fill 1 Detergent cup

† The Timer Knob will pause while water is being heated.  
 †† Cycle time includes dry time and may be longer depending on the temperature of water entering the dishwasher. The cooler the water, the longer the cycle time. If the water is already hot enough, the cycle times will be as shown.

continued on next page

# Cycles (cont.)

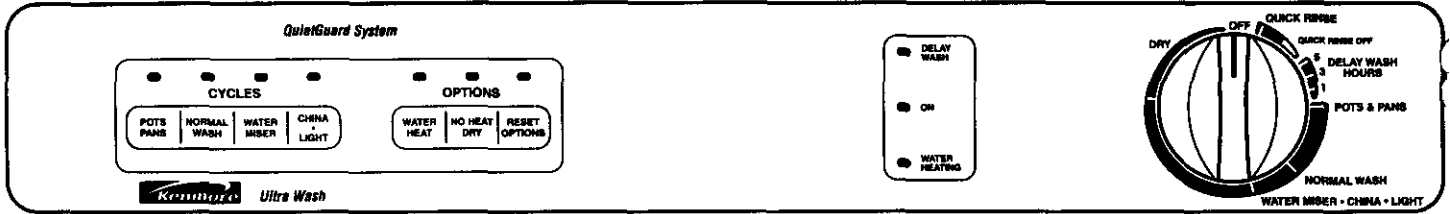

A "✓" shows what each cycle includes.

CYCLE	Wash	Rinse	Main Wash	Rinse	Dry	Cycle Time †† (min.)	Water Usage (gallons[US]/liters)	Detergent Dispenser Sections
<b>CHINA • LIGHT</b>  WATER MISER • CHINA • LIGHT			✓†	✓†	✓	62††	4.8/18.2	 Fill 1 Detergent cup

A light wash and gentle dry for china and crystal. If you have not selected No Heat Dry, the heating element cycles on and off during the drying part of the cycle.

- Select the Water Heat option to heat water to 135°F (57°C) in the main wash.
- Water automatically heats to 135°F (57°C) in the final rinse.

<b>QUICK RINSE</b> 				✓		6	2.2/8.3	 Fill 0 Detergent cups
------------------------	--	--	--	---	--	---	---------	---------------------------

For rinsing dishes that will be washed later.

† The Timer Knob will pause while water is being heated.

†† Cycle time includes dry time and may be longer depending on the temperature of water entering the dishwasher. The cooler the water, the longer the cycle time. If the water is already hot enough, the cycle times will be as shown.

# Options

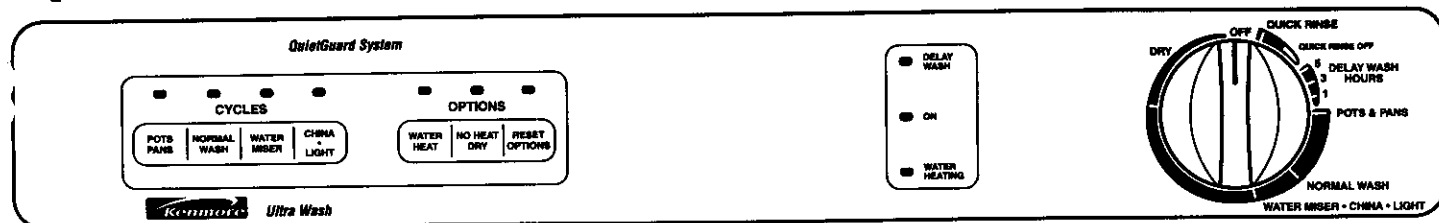

Option	When should I use it?	What does it do?
<b>Water Heat</b> <ul style="list-style-type: none"> <li>• Automatic with Pots &amp; Pans</li> <li>• Option for Normal Wash, Water Miser, and China•Light cycles</li> <li>• Not available for Quick Rinse cycle</li> </ul>	To ensure water temperature in Main Wash reaches 135°F (57°C).	<ul style="list-style-type: none"> <li>• When you select Water Heat, main wash delays until water heats to 135°F (57°C).</li> <li>• As water heats, washing action continues. Timer Knob pauses and Water Heating status indicator glows until water reaches proper temperature.</li> </ul>
<b>No Heat Dry</b> <ul style="list-style-type: none"> <li>• Option for Pots &amp; Pans, Normal Wash, Water Miser and China•Light cycles</li> </ul>	Use when you do not need a rapid dry cycle. Allow longer drying times (overnight). Use rinse agent to improve drying.	<ul style="list-style-type: none"> <li>• Turns off heating element in 30-minute dry period.</li> </ul>
<b>Reset Options</b>	To change option selection.	<ul style="list-style-type: none"> <li>• Cancels any previously selected options.</li> </ul>
<b>Delay Wash</b> <ul style="list-style-type: none"> <li>• Option for Pots &amp; Pans and Normal Wash.</li> <li>• Not available for Quick Rinse, Water Miser, and China•Light cycles</li> </ul>	Use when you want to start a cycle later. Set delay to run dishwasher during times when off-peak utility rates are in effect or when you are away from home. Local utilities recommend this to avoid heavy usage of energy at certain times of day.	<ul style="list-style-type: none"> <li>• Delay beginning of your selected cycle and options for up to 5 hours.</li> <li>• To set:               <ol style="list-style-type: none"> <li>1. Close the door firmly until you hear it latch.</li> <li>2. Select the desired Cycle and Options.</li> <li>3. Turn Timer Knob to the number of hours you want dishwashing to be delayed. The Delay Wash status indicator will glow.</li> </ol> </li> <li>• If you wish to put more dishes in the dishwasher while it is in delay mode, be sure to latch the door after you add them. The Timer Knob will not advance unless the door is latched. The amount of delay can be changed or canceled at any time before the cycle begins.</li> </ul>



# Status indicator lights

## Delay Wash

The Delay Wash status indicator **A** glows to indicate that the dishwasher is set to delay starting until a later time.

## On

The On status indicator glows during the wash, rinse, or dry portion of any cycle. It turns off when drying is complete.

## Water Heating

The Water Heating status indicator glows to indicate that the dishwasher is heating water to the proper dishwashing temperature if your household water is not hot enough.

**NOTE:** The Timer Knob will pause while this occurs.

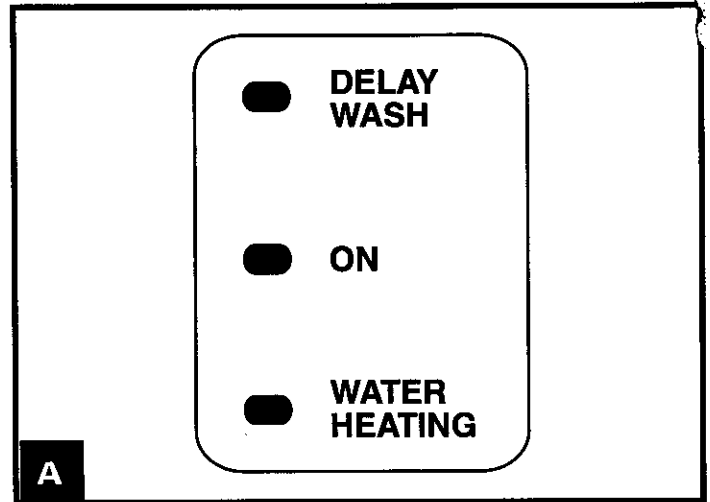

# Caring for Your Dishwasher

Your new dishwasher is designed to give you many years of dependable service. There are a few things you can do to maintain your dishwasher properly. This section tells you how to clean and care for your dishwasher. Refer to the "Troubleshooting Guide" section for special cleaning problems.

## Cleaning your dishwasher

### Cleaning the exterior

In most cases, regular use of a soft, damp cloth or sponge and a mild detergent is all that is necessary to keep the outside of your dishwasher nice looking and clean **B**.

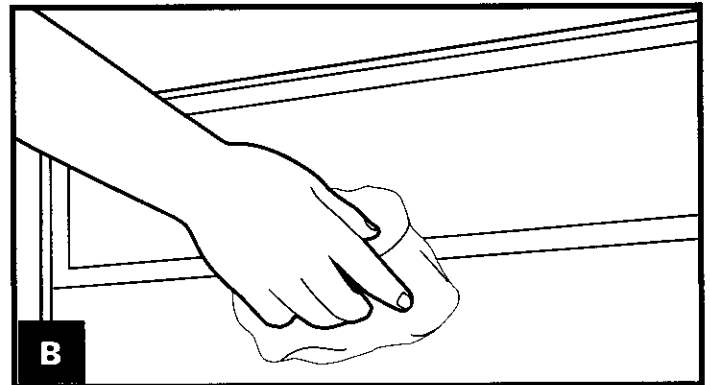

### Cleaning the interior

Hard water minerals may cause a white film to build up on the inside surfaces, especially just beneath the door area.

#### To clean interior:

1. Remove the bottom rack from your dishwasher.
2. Apply powdered dishwasher detergent to a damp sponge to make a paste.

#### OR

Use liquid automatic dishwasher detergent and clean with damp sponge **C**.

**Do not** clean the dishwasher interior until it has cooled. **Wear rubber gloves. Do not** use any type of cleanser other than dishwasher detergent because it may cause foaming or sudsing.

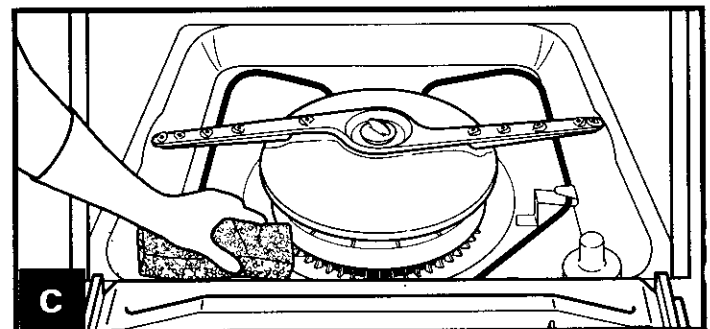

# Storing your dishwasher

## Moving or winterizing your dishwasher

Protect your dishwasher and home against water damage due to freezing water lines. If your dishwasher is left in a seasonal dwelling or could be exposed to near freezing temperatures, have a qualified person do the following:

1. Disconnect power supply to the dishwasher.
2. Turn off water supply to the dishwasher.
3. Remove the 4 screws on the lower access panel and remove the lower access panel **A**.
4. Place a shallow pan under the water supply valve. Then, use a wrench to disconnect the water inlet from the water supply valve. Separate the water inlet from the water supply valve and drain water into the pan **B**.
5. Remove the spring clamp from the water outlet and separate from the water supply valve; drain water into pan.
6. Reconnect both water inlet and water outlet to the water supply valve.
7. Empty the pan and reposition it under the water pump.
8. Remove the clamp and disconnect the drain hose from the water pump; drain water into pan.
9. Reconnect drain hose to the water pump, being sure to position the clamp over the connection.
10. Replace the lower access panel.

## Reconnecting your dishwasher

1. Remove the 4 screws on the lower access panel and remove lower access panel.
2. Turn on the water supply to dishwasher.
3. Turn on power supply to dishwasher.
4. Run dishwasher through a complete cycle and check for leaks.
5. Replace lower access panel.

**NOTE:** If your dishwasher is connected to a garbage disposal, do not run water into the sink after winterizing. This could cause water to refill the drain hose on your dishwasher.

## Storing for the summer

Protect your dishwasher during the summer months by turning off the water supply and power supply to the dishwasher.

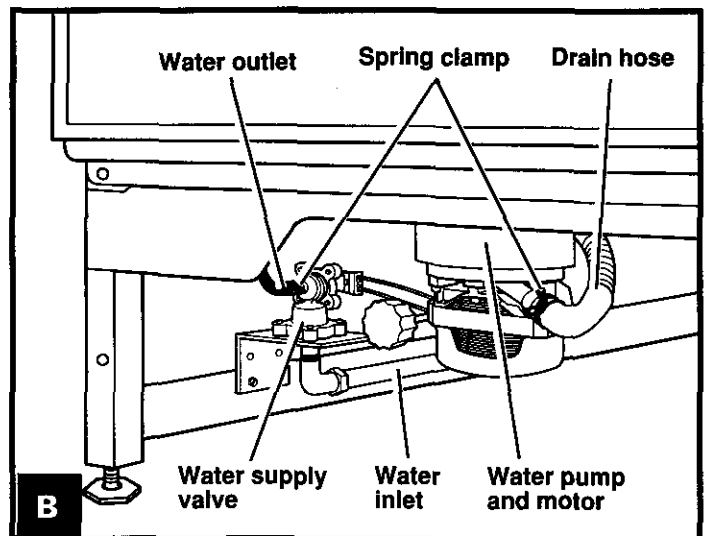
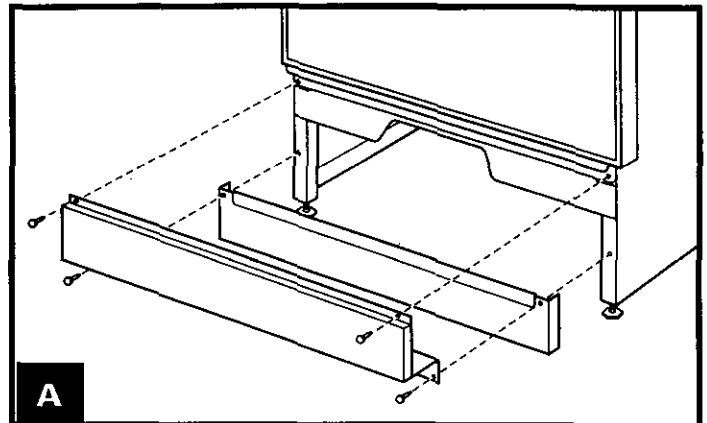

## Tips for washing special items

If you have any doubts about washing a particular item, check with the manufacturer to see if it is dishwasher safe.

<b>MATERIAL</b>	<b>DISHWASHER SAFE?</b>	<b>EXCEPTIONS/SPECIAL INFORMATION</b>
<b>Aluminum</b>	<b>Yes</b>	High water temperature and detergents may affect finish of anodized aluminum.
<b>Bottles and Cans</b>	<b>No</b>	Wash bottles and cans by hand. Labels attached with glue can loosen in your dishwasher. Loose labels and glue can clog spray arms or the pump and will reduce washing performance.
<b>Cast Iron</b>	<b>No</b>	Seasoning will be removed and iron will rust.
<b>China/Stoneware</b>	<b>Yes</b>	Always check manufacturer's recommendations before washing. Antique, hand-painted, or over-the-glaze patterns may fade. Gold leaf may discolor or fade.
<b>Crystal</b>	<b>Yes</b>	Always check manufacturer's recommendations before washing. Some types of leaded crystal may etch with repeated washings.
<b>Gold</b>	<b>No</b>	Gold-colored flatware will discolor.
<b>Glass</b>	<b>Yes</b>	Milk glass will yellow with repeated dishwasher washing.
<b>Hollow-Handle Knives</b>	<b>No</b>	Handles of some knives are attached to the blade with adhesives which may loosen if washed in the dishwasher.
<b>Pewter</b>	<b>No</b>	High water temperatures and detergent may discolor or pit finish.
<b>Disposable Plastics</b>	<b>No</b>	Cannot withstand high water temperatures and detergents.
<b>Plastics</b>	<b>Yes</b>	Always check manufacturer's recommendations before washing. Plastics vary in their capacity to withstand high water temperatures and detergents. Load plastics in top rack only.
<b>Stainless Steel</b>	<b>Yes</b>	Run a Quick Rinse cycle if not washing immediately. Prolonged contact with food containing salt, vinegar, milk products, or fruit juice could damage finish.
<b>Sterling Silver or Silver Plate</b>	<b>Yes</b>	Run a Quick Rinse cycle if not washing immediately. Prolonged contact with food containing salt, acid, or sulfide (eggs, mayonnaise, and seafood) could damage finish.
<b>Tin</b>	<b>No</b>	Can rust.
<b>Wooden Ware</b>	<b>No</b>	Wash by hand. Always check manufacturer's recommendations before washing. Untreated wood may warp, crack, or lose its finish.

# Troubleshooting Guide

## Dishwasher is not operating properly

PROBLEM ...	CAUSE ...	SOLUTION ...
<b>Dishwasher does not run or stops during a cycle</b>	<p>Door not closed</p> <p>Wrong cycle selected</p> <p>No or improper power supplied to dishwasher</p> <p>Motor stopped due to overload</p> <p>No water supplied to dishwasher</p>	<p>Make sure door is closed and securely latched.</p> <p>Refer to the "Cycles" section, page 13.</p> <p>Check to see if household fuse or circuit breaker is blown or tripped.</p> <p>Motor will automatically reset itself within a few minutes. If it does not restart, call for service.</p> <p>Check to see if shut-off valve (if installed) is turned on.</p>
<b>Dishwasher will not fill</b>	Overfill protector stuck	Check to see if the overfill protector moves up and down freely. Press down to release.
<b>Dishwasher seems to run too long</b>	Water supplied to dishwasher is not hot enough	<p>It is normal for the dishwasher to run longer while heating water. Refer to the "Water temperature tips" section, page 12.</p> <ul style="list-style-type: none"> <li>• A delay will occur in the main wash if the Water Heat option is selected.</li> <li>• Three delays will occur if the Pots &amp; Pans cycle is selected.</li> <li>• The final rinse automatically delays until the water reaches proper temperature.</li> </ul>
<b>Water remains in dishwasher</b>	Cycle not finished	Wait for the cycle to complete.
<b>Detergent remains in covered section of dispenser</b>	<p>Cycle not finished</p> <p>Detergent has lumps</p> <p>Bottom rack in backwards</p>	<p>Wait for the cycle to complete.</p> <p>Replace with dry, lump-free detergent.</p> <p>Refer to the "Parts and Features" section, page 3 and reinstall rack if necessary.</p>
<b>White residue appears on front of access panel</b>	<p>Too much detergent was used</p> <p>Brand of detergent developing excess foam</p>	<p>Refer to the "Using the detergent dispenser" section, page 11.</p> <p>Try a different brand to reduce foaming and eliminate buildup.</p>
<b>Odor in the dishwasher</b>	<p>Dishes only washed every 2-3 days</p> <p>Plastic smell of new dishwasher</p>	<p>Run a Quick Rinse cycle at least once or twice a day until full load is accumulated.</p> <p>Run a vinegar rinse, as described on the next page.</p>
<b>Condensation on kitchen counter</b>	Excessive moisture from vent in dishwasher console	Dishwasher console should be aligned with countertop. Refer to Installation Instructions for more information.

## Dishes are not cleaned completely

<b>Food soil left on dishes</b>	Improper loading	Refer to the "Loading Your Dishwasher" section, pages 7-10.
	Water temperature is too low	Use the Water Heat option. If needed, turn home water heater up to ensure water entering dishwasher is 120°F (49°C) minimum. Refer to the "Water temperature tips" section, page 12.
	Use of incorrect, too little, or ineffective detergent	Use recommended dishwasher detergents only. Refer to the "Using the detergent dispenser" section, page 11. Never use less than one tablespoon per load. Detergent must be fresh to be effective. Always store detergent in a cool, dry area.

# Troubleshooting Guide (cont.)

## Dishes are not cleaned completely (cont.)

PROBLEM ...	CAUSE ...	SOLUTION ...
<b>Food soil left on dishes (cont.)</b>	Detergent cakes in dispenser	Use fresh detergent only. Do not allow detergent to sit for several hours in a wet dispenser. Check dispenser for caked detergent. Clean dispenser when caked detergent is present.
	Pump or spray arm clogged by labels from bottles and cans	Remove labels before washing bottles and cans or wash by hand. Refer to the "Tips for washing special items" section, page 18.
	Insufficient fill caused by low water pressure	Home water pressure should be 20 to 120 psi (138-828 kPa) for proper dishwasher fill. A booster pump on the water supply may be necessary if pressure is too low.
	Slowdown of wash arm due to high suds	Never use soap or laundry detergents. Use recommended dishwasher detergents only.

## Spots or stains on dishes

<b>Spotting and filming</b>	Hard water or high mineral content in water	Conditioning the final rinse water with a liquid rinse agent helps eliminate spotting and filming. Keep the dispenser full with a rinse agent at all times.
	Water temperature is too low	Use the Water Heat option. If needed, turn home water heater up to ensure water entering dishwasher is 120°F (49°C) minimum. Refer to the "Water temperature tips" section page 12.
	Use of incorrect detergents	Use recommended dishwasher detergents only.
	Incorrect amount of detergent	Refer to the "Using the detergent dispenser" section, page 11. Heavy soil and/or hard water generally require extra detergent.
	Use of ineffective detergents	Detergent should be fresh. Store in a cool, dry place, preferably in an airtight container. Discard lumpy detergent.
Insufficient fill caused by low water pressure	Home water pressure should be 20 to 120 psi (138-828 kPa) for proper dishwasher fill. A booster pump on the water supply may be necessary if pressure is too low. <b>NOTE:</b> To remove spots and film from dishes, try a <b>vinegar rinse</b> . <ol style="list-style-type: none"> <li>1. Wash and rinse as usual using the No Heat Dry option.</li> <li>2. Remove all metal items.</li> <li>3. Put 2 cups (500 mL) white vinegar in a container on the bottom rack.</li> <li>4. Run dishwasher through complete washing cycle. Vinegar will mix with wash water.</li> </ol>	
<b>Silica film or etching</b> (silica film is a white iridescent deposit; etching is a cloudy film)	A water chemical reaction with certain types of glassware. Usually caused by some combination of soft or softened water, alkaline washing solutions, insufficient rinsing, overloading the dishwasher, and heat of drying.	It may not be possible to prevent problem, except by hand washing. To slow this process, use a minimum amount of detergent but not less than 1 tablespoon per load. Use a liquid rinse agent and underload the dishwasher to allow thorough rinsing. Silica film and etching are permanent and cannot be removed. Use the No Heat Dry option.

# Troubleshooting Guide (cont.)

## Spots or stains on dishes (cont.)

PROBLEM ...	CAUSE ...	SOLUTION ...
<b>White spots on cookware with non-stick finish</b>	Seasoning removed by dishwasher detergents	Reseason cookware after dishwasher washing.
<b>Brown stains on dishes and dishwasher interior</b>	High iron content in water supply	Remove by washing dishes (after food soil has been removed) with 1 teaspoon to 1 tablespoon of citric acid crystals added to covered section of detergent dispenser. Do not use detergent. Follow with a Normal Wash cycle with detergent. If treatment is needed more often than every other month, the installation of an iron removal unit is recommended.
<b>Black or gray marks on dishes</b>	Aluminum items	Aluminum items should be loaded so that they will not rub against dishes during washing. Throwaway aluminum items should not be washed in the dishwasher because they may break down and cause marking. Aluminum markings can be removed by using a mild abrasive cleanser.
<b>Orange stains on plastic dishes or dishwasher interior</b>	Large amounts of tomato-based foods on dishes placed in the dishwasher	Stains may gradually fade over time. Regular use of heated drying may cause stains to fade slower. Stains will not affect dishwasher performance. Regular use of Quick Rinse cycle or No Heat Dry option will reduce the likelihood of staining.

## Dishes do not dry completely

<b>Dishes are not dry</b>	Dishes do not drain properly	Dishes must have proper water drainage. Do not overload. Refer to the "Loading Your Dishwasher" section, pages 7-10. Use a liquid rinse agent to speed drying.
	Plastics	Some plastics, due to material, may need to be towel dried.
	Rinse agent dispenser is empty	Refer to the "Using the rinse agent dispenser" section, page 12.
	No Heat Dry option was used	Do not use the No Heat Dry option.

## Dishes are damaged during cycle

<b>Chipping of dishes</b>	Improper loading	Load dishes and glasses so that they are stable and do not strike together from washing action. Moving rack in and out slowly will also minimize chipping. <b>NOTE:</b> Some types of china and glassware are too delicate for automatic dishwashing and should be hand washed; for example: antiques, feather-edged crystal, and similar types.
---------------------------	------------------	---

## Noises

<b>Grinding, grating, crunching, or buzzing sounds</b>	Hard object entered the Ultra Wash module	Sound should stop when object is ground up.
--	---	---

# We Service What We Sell

"We Service What We Sell" is our assurance you can depend on Sears for service. Your dishwasher has added value when you consider that Sears has service units nationwide, staffed with professional technicians specifically trained on Sears appliances and having the parts, tools, and equipment to ensure that we meet our pledge to you ... "We Service What We Sell."

## **Sears Maintenance Agreement**

Maintain the value of your KENMORE Dishwasher with a Sears Maintenance Agreement. Sears dishwashers are designed, manufactured, and tested for years of dependable operation. Yet, any modern appliance may require service from time to time.

### **The Sears Maintenance Agreement:**

- Is your way to buy tomorrow's service at today's prices.
- Eliminates repair bills resulting from normal use.
- Allows for as many service calls as required.
- Provides for service by professional Sears Trained Technicians.
- Even if you don't need repairs, the Maintenance Agreement offers an annual preventative maintenance check-up at your request!

This Maintenance Agreement does not cover original installation, reinstallation, or damage resulting from external causes such as acts of abuse, theft, fire, flood, wind, lightning, freezing, power failure, power reduction, etc.

# Sears Repair Services in U.S.A.:

For the repair or replacement  
parts you need

Call 7 am - 7 pm, 7 days a week

**1-800-366-PART**

(1-800-366-7278)

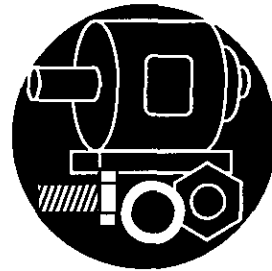

For in-home major brand repair service

Call 24 hours a day, 7 days a week

**1-800-4-REPAIR**

(1-800-473-7247)



For the location of a Sears Repair  
Service Center in your area

Call 24 hours a day, 7 days a week

**1-800-488-1222**



For information on purchasing a Sears  
Maintenance Agreement or to inquire  
about an existing Agreement

Call 9 am - 5 pm, Monday - Saturday

**1-800-827-6655**



The model number of your product is located on  
the serial plate beneath the top handle.  
When requesting service or ordering parts, always  
provide the following information:

- Product Type
- Model Number
- Part Number
- Part Description

**SEARS**  
**REPAIR SERVICES**  
*America's Repair Specialists*

For information on parts and service in Canada, call:

**1-800-665-4455**





## Free Manuals Download Website

<http://myh66.com>

<http://usermanuals.us>

<http://www.somanuals.com>

<http://www.4manuals.cc>

<http://www.manual-lib.com>

<http://www.404manual.com>

<http://www.luxmanual.com>

<http://aubethermostatmanual.com>

Golf course search by state

<http://golfingnear.com>

Email search by domain

<http://emailbydomain.com>

Auto manuals search

<http://auto.somanuals.com>

TV manuals search

<http://tv.somanuals.com>