



Dishwasher

Use & Care Guide

Lavavajillas

Manual de uso y cuidado

Model/Modelo 587.15072, 587.15073, 587.15074, 587.15079
587.16072, 587.16073, 587.16074, 587.16079

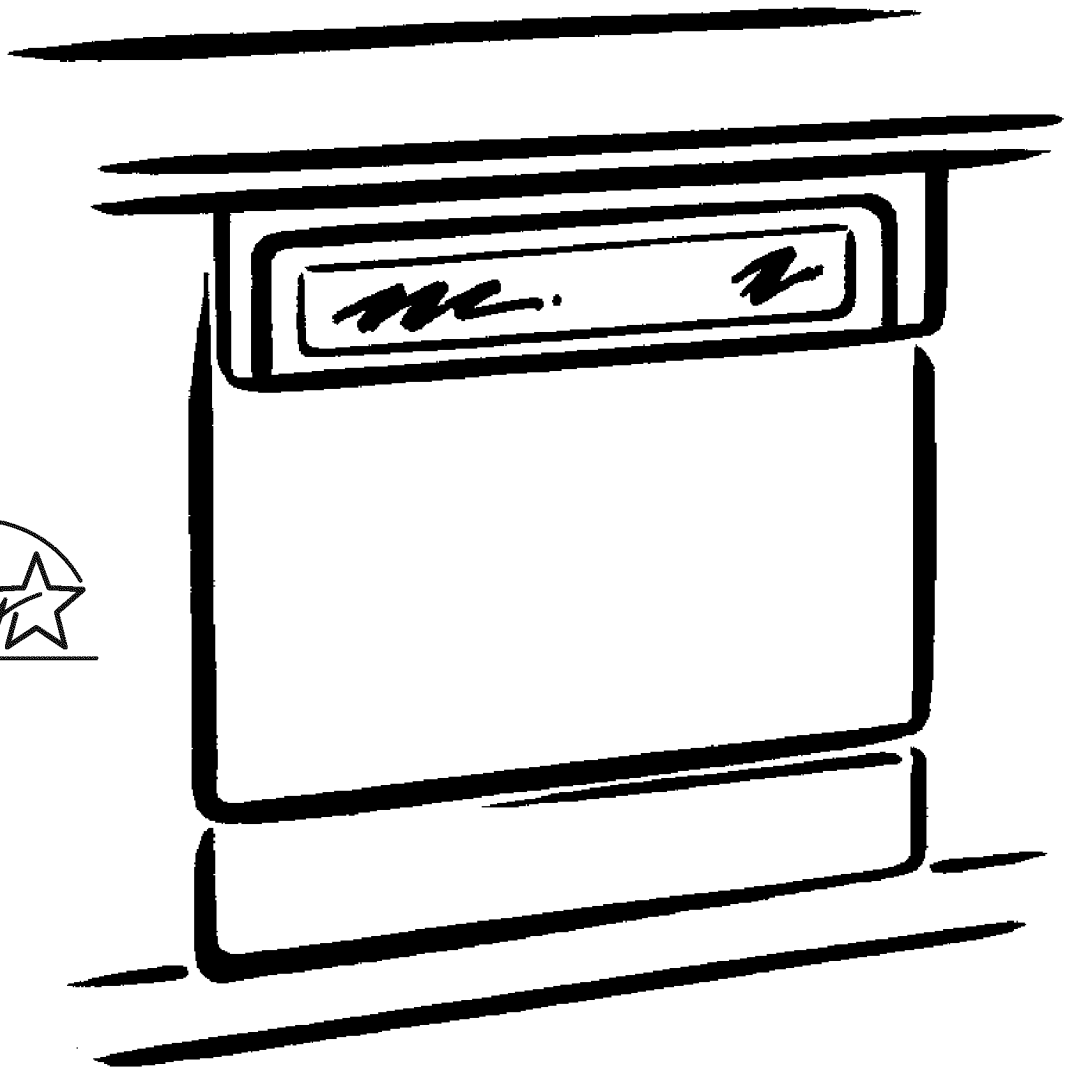

ENGLISH

ESPAÑOL

Table of Contents

Warranty	3
Safety Instructions	4
Before Using Your Dishwasher	5
Dishwasher Features	6
Wash System	7
Operating Instructions	8-10
Preparing and Loading Dishes	11-14
Dishwasher Dispenser and Detergents	15-16
Factors Affecting Performance	16
Care and Cleaning	17
Solutions to Common Dishwashing Problems	18-20
Service	Back Cover

Master Protection Agreements

Congratulations on making a smart purchase. Your new Kenmore® appliance is designed and manufactured for years of dependable operation. But like all products, it may require preventive maintenance or repair from time to time. That's when having a Master Protection Agreement can save you money and aggravation.

Purchase a Master Protection Agreement now and protect yourself from unexpected hassle and expense.

The Master Protection Agreement also helps extend the life of your new appliance. Here's what's included in the Agreement:

- Expert Service** by our 12,000 professional repair specialists
- Unlimited service and no charge** for parts and labor on all covered repairs
- “No-lemon” guarantee** – replacement of your covered product if more than three product failures occur within twelve months
- Product replacement** if your covered product can't be fixed
- Annual Preventive Maintenance Check** at your request - no extra charge
- Fast help by phone** – non-technical and instructional assistance on products repaired in your home, plus convenient repair scheduling
- Power surge protection** against electrical damage due to power fluctuations
- Rental reimbursement** if repair of your covered product takes longer than promised

Once you purchase the Agreement, a simple phone call is all that it takes for you to schedule service. You can call anytime day or night, or schedule a service appointment online.

Sears has over 12,000 professional repair specialists, who have access to over 4.5 million quality parts and accessories. That's the kind of professionalism you can count on to help prolong the life of your new purchase for years to come. Purchase your Master Protection Agreement today!

Some limitations and exclusions apply. For prices and additional information call 1-800-827-6655.

Sears Installation Service

For Sears guaranteed professional installation of home appliances and items like garage door openers and water heaters, in the U.S.A. call 1-800-4-MY-HOME®.

Warranty

FULL ONE-YEAR WARRANTY ON KENMORE DISHWASHERS

For one year from the date of purchase, when this dishwasher is installed and operated according to instructions provided in the Installation Instructions and Use & Care Guide, Sears will repair this dishwasher, free of charge, if defective in material or workmanship.

FULL TWO-YEAR WARRANTY ON ELECTRONIC CONTROL AND POWER SUPPLY BOARD

For two years from the date of purchase, when this dishwasher is installed and operated according to instructions provided in the Installation Instructions and Use & Care Guide, Sears will repair, free of charge, the electronic module and power supply board if defective in material or workmanship.

FULL TWENTY FIVE-YEAR WARRANTY AGAINST LEAKS IN THE TUB AND INNER DOOR PANEL

For twenty five years from the date of purchase, if a leak should occur as a result of failure of the polypropylene tub or inner door panel due to cracking, chipping or peeling, Sears will replace free of charge the tub or inner door panel.

LIMITED TWO-YEAR WARRANTY ON THE WASH SYSTEM

After the first year and until two years from the date of purchase, when the dishwasher is installed and operated in accordance with the instructions provided in the Installation Instructions and Use & Care Guide, Sears will replace any part of the wash system (motor, pump, spray arms, supply tube, filter assembly and pump gasket) due to defective materials or workmanship. Customer assumes any labor costs associated with replacement of these parts.

WARRANTY RESTRICTION

If the dishwasher is subject to other than private family use, the above warranty coverage is effective for only 90 days.

WARRANTY SERVICE

WARRANTY SERVICE IN THE U.S.A. IS AVAILABLE BY CONTACTING SEARS AT **1-800-4-MY-HOME®**. This warranty applies only while the product is in use in the United States. This warranty gives you specific legal rights and you may also have other rights which vary from state to state.

For Sears Warranty information in the United States, please reference the service numbers located on the back page of this manual.

**Sears, Roebuck and Co.,
Dept. 817WA, Hoffman Estates, IL 60179**

In the space below, record your complete model number, serial number and purchase date. You can find this information on the model and serial number label, located as shown in the Dishwasher Features section of this book. Have this information available to help you quickly obtain assistance or service when you contact Sears concerning your appliance.

Model Number: 587. _____

Serial Number: _____

Purchase Date: _____

Save these instructions and your sales receipt for future reference.

ENGLISH

Dishwasher Safety

Your safety and the safety of others are very important.

We have provided many important safety messages in the manual and on your appliance. Always read and obey all safety messages.



This is the safety alert symbol.

This symbol alerts you to potential hazards that can kill or hurt you and others.

All safety messages will follow the safety alert symbol and either the word "DANGER" or "WARNING." These words mean:

⚠ DANGER

You can be killed or seriously injured if you don't immediately follow instructions.

⚠ WARNING

You can be killed or seriously injured if you don't follow instructions.

All safety messages will tell you what the potential hazard is, tell you how to reduce the chance of injury, and tell you what can happen if the instructions are not followed.

IMPORTANT SAFETY INSTRUCTIONS

WARNING: When using the dishwasher, follow basic precautions, including the following:

- Read all instructions before using the dishwasher.
- Use your dishwasher only as instructed in this Use and Care Guide.
- Use only detergents or rinse agents recommended for use in a dishwasher, and keep them out of the reach of children.
- When loading items to be washed:
 - Locate sharp items and knives so that they are not likely to damage the door seal or tub.
 - Load sharp items and knives with the handles up to reduce the risk of cut-type injuries.
- Do not wash plastic items unless marked "dishwasher safe" or the equivalent. Check with manufacturer for recommendations, if not marked. Items that are not dishwasher safe may melt and create a potential fire hazard.
- Do not touch the heating element during or immediately after use.
- Do not operate your dishwasher unless all enclosure panels are properly in place.
- If the dishwasher drains into a food disposer, make sure disposer is completely empty before running dishwasher.
- Disconnect electrical power to dishwasher before servicing.
- Do not tamper with controls.
- Do not let children abuse, sit, stand or play on door or racks of a dishwasher.
- Keep young children and infants away from dishwasher when it is operating.
- Use care unloading the dishware when the SANITIZE option has been selected. Contents may be hot to the touch immediately after the end of cycle.
- Water vapor from the vent may be hot to the touch when the SANITIZE option has been selected. Use care and do not let small children play around or touch the vent area of the dishwasher.
- Under certain conditions, hydrogen gas may be produced in a hot water system that has not been used for two weeks or more. **HYDROGEN GAS IS EXPLOSIVE.** If the hot water system has not been used for such a period, before using the dishwasher turn on all hot water faucets and let the water flow from each for several minutes. This will release any accumulated hydrogen gas. As the gas is flammable, do not smoke or use an open flame during this time.
- To avoid entrapment and/or suffocation, remove door or door latch mechanism from any dishwasher that is discarded or not in use.

SAVE THESE INSTRUCTIONS

ENGLISH

Before Using Your Dishwasher

⚠ WARNING

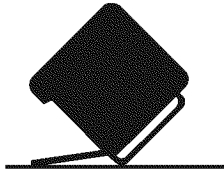

Tip Over Hazard

Do not use dishwasher until completely installed.

Do not push down on open door.

Doing so can result in serious injury or cuts.

⚠ WARNING



Electrical Shock Hazard

Electrically ground dishwasher.

Connect ground wire to green ground nut in terminal box.

Do not use an extension cord.

Failure to do so can result in death, fire, or electrical shock.

GROUNDING INSTRUCTIONS

■ For a grounded, cord-connected dishwasher:

The dishwasher must be grounded. In the event of a malfunction or breakdown, grounding will reduce the risk of electric shock by providing a path of least resistance for electric current. The dishwasher is equipped with a cord having an equipment-grounding conductor and a grounding plug. The plug must be plugged into an appropriate outlet that is installed and grounded in accordance with all local codes and ordinances.

WARNING: Improper connection of the equipment-grounding conductor can result in a risk of electric shock. Check with a qualified electrician or service representative if you are in doubt whether the dishwasher is properly grounded. Do not modify the plug provided with the dishwasher. If it will not fit the outlet, have a proper outlet installed by a qualified electrician.

■ For a permanently connected dishwasher:

The dishwasher must be connected to a grounded metal, permanent wiring system, or a equipment-grounding conductor must be run with the circuit conductors and connected to the equipment-grounding terminal or lead on the dishwasher.

SAVE THESE INSTRUCTIONS

ENGLISH

Dishwasher Features

ENGLISH

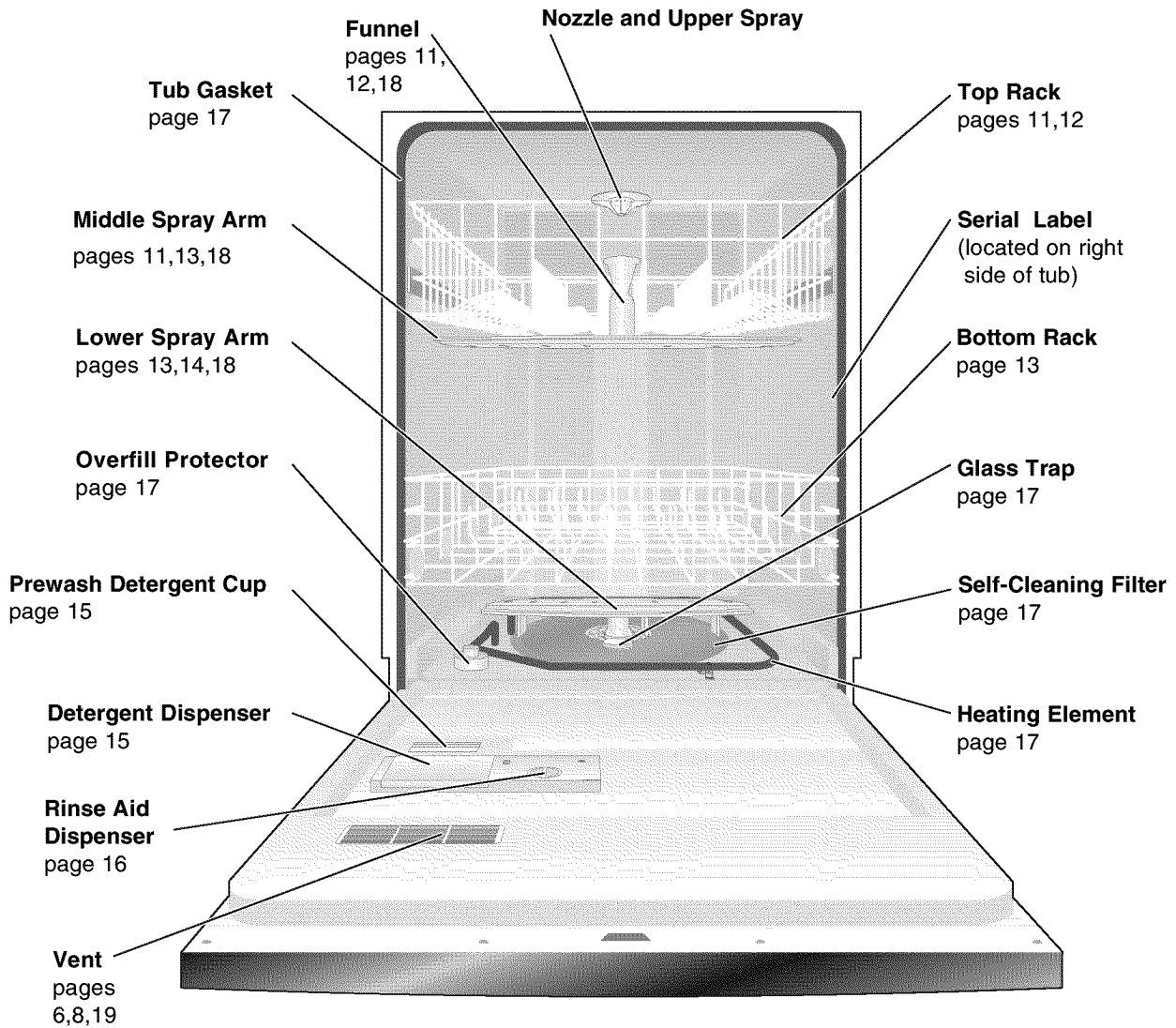

Control Panel

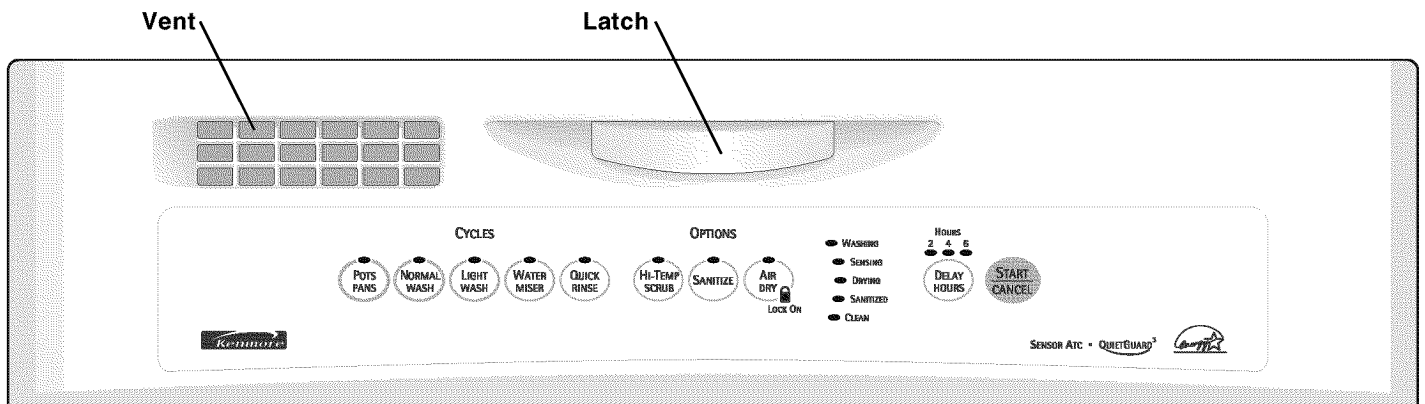

Wash System

Your Kenmore dishwasher filters 100% of the water for optimum cleaning. The wash system uses alternating arms to save water and energy and includes:

- A soil sensor that checks the soil level in the first wash and first rinse. When the soil level is determined, additional water fills may be added or deleted. This optimizes the efficiency of the dishwasher while maintaining superb wash performance.
- An Automatic Temperature Control (ATC) that guarantees the proper water temperature for the selected wash cycle. The ATC adjusts the water temperature in the main wash and final rinse of the selected cycle. The higher water temperature improves cleaning and drying.
- A heavy-duty stainless steel food disposer that grinds up large food particles.

How the wash system works

1. Load the dishwasher (See Preparing and Loading Dishes).
2. Hot water enters the dishwasher and covers the filter.
3. Detergent is dispensed at the appropriate time and mixed with the hot water. This mixture is pumped through the lower spray arm and sprays against the soiled surfaces of the dishes to remove food particles.
4. Water passes through the fine mesh primary filter where food soil is removed and the clean water is then recirculated.
5. Ports under the lower wash arm direct the food soil through a secondary filter into a collection chamber.
6. Food soil is held in the collection chamber until it is flushed away during the drain cycle.
7. Clean, hot water enters the dishwasher and the sequence is repeated.
8. Beginning with the third water fill, the wash action switches between the lower spray arm and middle spray arm in 90 second intervals. You may notice a change in sound as the wash action pauses and switches to the other arm.
9. The dishwasher may pause during the cycle while water is being heated. Wash action will continue during this time.
10. The final rinse water is heated and rinse aid is automatically dispensed to aid in drying.

Operating Instructions

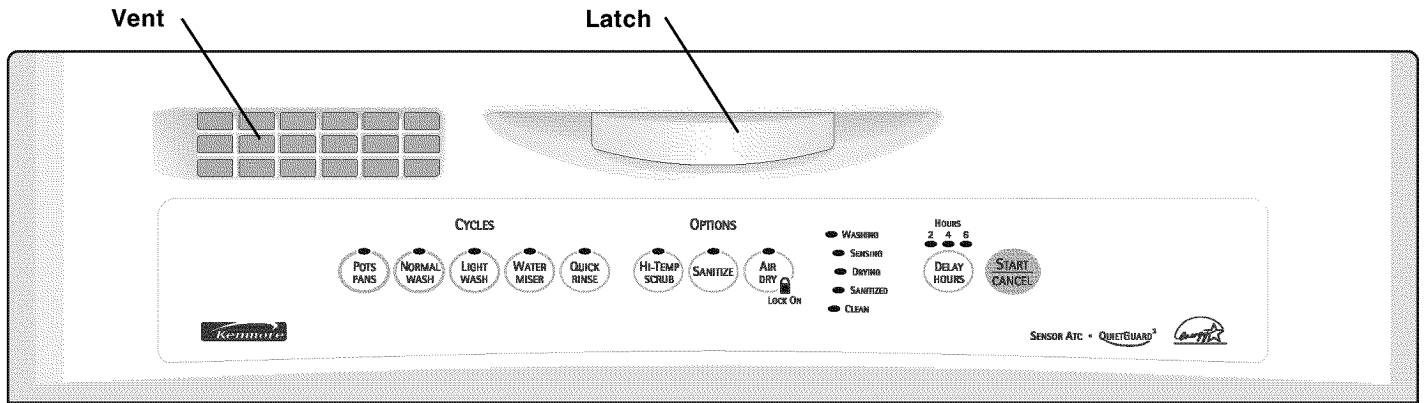

Getting Started

1. Load dishwasher (See Preparing and Loading Dishes).

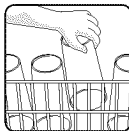

6. Select desired OPTIONS (See Option Selections). The indicator light above the pad will glow when selected.

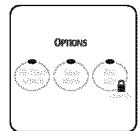

2. Add detergent (See Dishwasher Dispenser & Detergents).

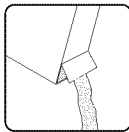

7. Run hot water faucet nearest dishwasher until water is hot. Turn water off.

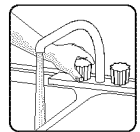

3. Add rinse aid, if needed (See Rinse Aid).

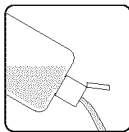

8. To start, press START/CANCEL pad. Or press START/CANCEL pad to repeat the same cycle and options as the previous cycle.

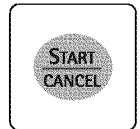

4. Close door to latch.

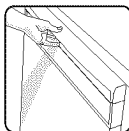

5. Select desired CYCLE (See Cycle Chart). The indicator light above the pad will glow when selected.







Wash Cycle Selections

Cycle times are approximate and will vary with options selected.

- Hot water is necessary to activate dishwasher detergent and melt fatty food soils.
- An automatic sensor will check the incoming water temperature and, if it is not hot enough, the timer will be delayed for automatic water heating in the main wash.
 - This happens even when HI-TEMP SCRUB option has not been selected.
 - When HI-TEMP SCRUB is selected, an even higher temperature will be guaranteed to handle heavier soil loads.

ENGLISH

Operating Instructions (continued)

Cycle Chart					
Cycle	To Select Cycle	Soil Level	Water (approx.)	Time* (minutes)	Washes/Rinses
 For pots, pans, casseroles and dinnerware with dried-on or baked-on soils.	Select POTS PANS and desired OPTIONS. HI-TEMP SCRUB and SANITIZE will automatically be provided.	Heavy and Medium	9.7 gal. 36.7 liters	115	2 washes 6 rinses
		Light	7.3 gal. 27.6 liters	95	2 washes 4 rinses
 For regularly soiled dishes and silverware.	Select NORMAL WASH and desired OPTIONS.	Heavy	8.5 gal. 32.2 liters	105	2 washes 5 rinses
		Medium	7.3 gal. 27.6 liters	95	2 washes 4 rinses
		Light	4.9 gal. 18.5 liters	75	2 washes 2 rinses
 For lightly soiled and pre-rinsed dishes and silverware.	Select LIGHT WASH and desired OPTIONS.	Heavy	8.5 gal. 32.2 liters	105	1 wash 6 rinses
		Medium	6.1 gal. 23.1 liters	85	1 wash 4 rinses
		Light	4.9 gal. 18.5 liters	75	1 wash 3 rinses
 For lightly soiled or pre-rinsed dishes and silverware. This cycle uses less hot water.	Select WATER MISER and desired OPTIONS.		3.7 gal. 14.0 liters	65	1 wash 2 rinses
 For rinsing dishes that will be washed later.	Select QUICK RINSE. DO NOT USE detergent.		2.5 gal. 9.5 liters	18	2 rinses

* Includes dry time.

Option Selections

Hi-Temp Scrub



When HI-TEMP SCRUB option is selected, the dishwasher heats the water in the main wash to approximately 145°F (63°C).

This increase in water temperature helps dishwasher detergent remove food grease and soil from dishes more effectively and aids in drying. HI-TEMP SCRUB option can be used with all cycles except WATER MISER and QUICK RINSE. HI-TEMP SCRUB is automatically provided when POTS PANS cycle is selected.

When HI-TEMP SCRUB option is selected, the light above the pad will come on and remain on until end of cycle. To turn off the HI-TEMP SCRUB option, press the pad a second time. The light above the pad will turn off.

Sanitize Option



To sanitize your dishes and glassware, select the SANITIZE option.

When selected, the light above the pad will come on and remain on until end of cycle. The water temperature in the final rinse will be raised to 155°F (68°C) and will maintain that temperature for 9 minutes. This option is available in Pots Pans, Normal and Light Wash cycles.

The cycle time will be extended until the proper water temperature is reached. Washing action will continue during the water heating delay. For best results, the incoming water temperature should be 120°F (49°C).

The sanitize criteria may not be satisfied if there is an interruption of the cycle, power failure or if the incoming water temperature is below 120°F (49°C).

To turn off the SANITIZE option, press the pad a second time. The light above the pad will turn off.

ENGLISH

Operating Instructions (continued)

Air Dry



The AIR DRY option saves electricity since the heating element is off during drying portion of cycle.

When selected, the light above the pad will come on and remain on until end of cycle. To speed the drying process, open the door slightly after the cycle is complete. Some water droplets may remain on door and tub and in areas where dishes touch silverware basket and rack.

To select heated dry, press the pad a second time. The light above the pad will turn off. Heated dry provides faster drying since the heating element is on during the drying portion of the cycle.

You may see water vapor coming from the vent during the drying portion of cycle. The vent is closed during washing to hold moisture and sound inside and then opens for drying. The drying option may be changed at any time during the cycle and affects only the drying period.

Opening the door longer than one minute during the dry cycle cancels the selected dry program.

Lock On



Lock the controls to prevent children from accidentally changing the cycle or starting the dishwasher.

To lock the controls, press and release the AIR DRY pad, then press and hold the AIR DRY pad for 5 seconds. The LOCK ON light will come on and no new selections can be made until the lock is released. To unlock the controls, press the AIR DRY pad for 5 seconds until the LOCK ON light goes out.

Delay Hours



The DELAY HOURS option allows you to delay starting your dishwasher up to 6 hours.

Press the DELAY HOURS pad once for a 2-hour delay, twice for 4 hours and three times for 6 hours. A light will come on indicating the delay start hours and will remain on until cycle starts.

To cancel the DELAY HOURS option and begin the cycle before the delay period is over, press the START/CANCEL pad.

To Cancel a Cycle



You can cancel a cycle anytime during the cycle. Press START/CANCEL pad and the dishwasher will start a 90 second drain. At the end of the drain, select the desired cycle.

Status Indicator Lights

- WASHING
- SENSING
- DRYING
- SANITIZED
- CLEAN

The WASHING light comes on at the beginning of cycle and remains on until the end of the final rinse.

The SENSING light comes on at the beginning of the selected cycle and will remain on until the end of the sensing sequence.

The DRYING light indicates the drying portion of the cycle. The light will come on when either drying option is selected.

When the SANITIZE option is selected, the SANITIZED light will glow when the SANITIZE cycle is finished. If the dishwasher did not properly sanitize the dishes, the light will not come on. This can happen if the cycle is interrupted. The light will remain on until the door is opened.

The CLEAN light will come on at end of cycle and remain on until door is opened.

Preparing and Loading Dishes

Dish Preparation

Scrape away large pieces of food, bones, pits, toothpicks, etc. The continuous filtered wash system will remove remaining food particles. Burned-on foods should be loosened before loading. Empty liquids from glasses and cups.

Foods such as mustard, mayonnaise, vinegar, lemon juice and tomato based products may cause discoloration of stainless steel and plastics if allowed to sit for a long period of time. Unless the dishwasher is to be operated at once, it is best to rinse off these food soils.

- Load racks so that large items do not prevent the detergent dispenser from opening.
- Check manufacturer's recommendations before washing items in question.
- If the dishwasher drains into a food disposer, **be sure disposer is completely empty before starting dishwasher.**

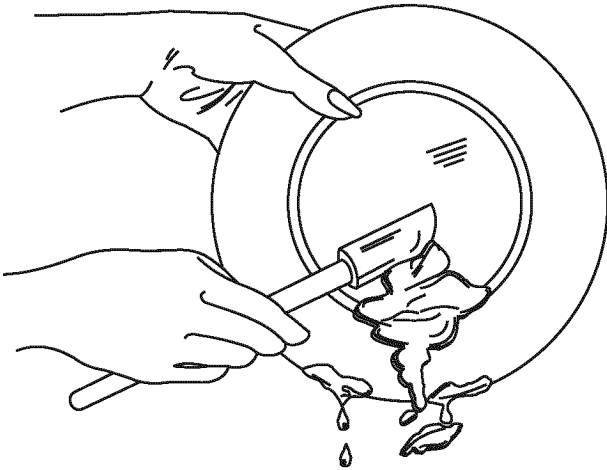

Loading the Top Rack

Features and appearance of racks and silverware basket may vary from your model.

Important: Do not cover the funnel when loading.

The top rack is designed for flexibility in loading a wide variety of items including cups, glasses, stemware, small plates, bowls, etc.

Load glasses in top rack. Damage may occur if placed in bottom rack.

Load plastic items in top rack only. Melting may occur if placed in bottom rack.

Load items with open ends facing down for better cleaning and draining.

Damage may occur if delicate items touch each other during dishwasher operation.

Long-handled knives and utensils can be placed in top rack.

Be sure nothing protrudes through the bottom of the rack to block rotation of middle spray arm.

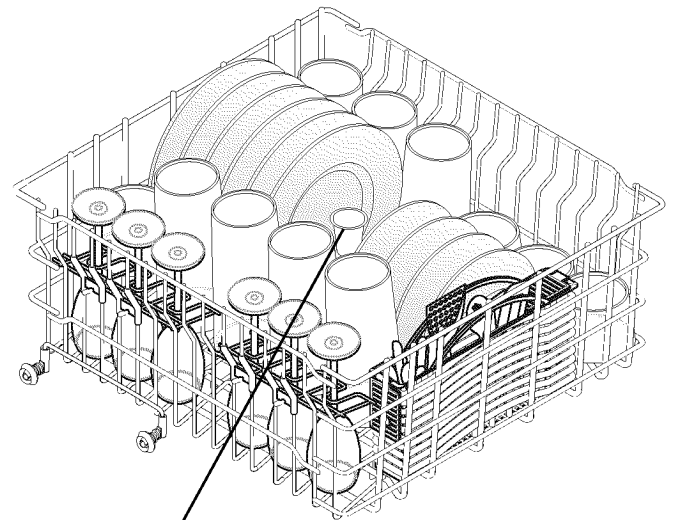

Do not cover funnel

ENGLISH

Preparing and Loading Dishes (continued)

Split Cup Shelves/Stemware Holders

The cup shelves/stemware holders handle your delicate stemware with care. They can also be used to hold two layers of cups, mugs and other short items. When using both levels, alternate items with layer below so that water can reach all inside surfaces. Fold holders up to load tall glasses.

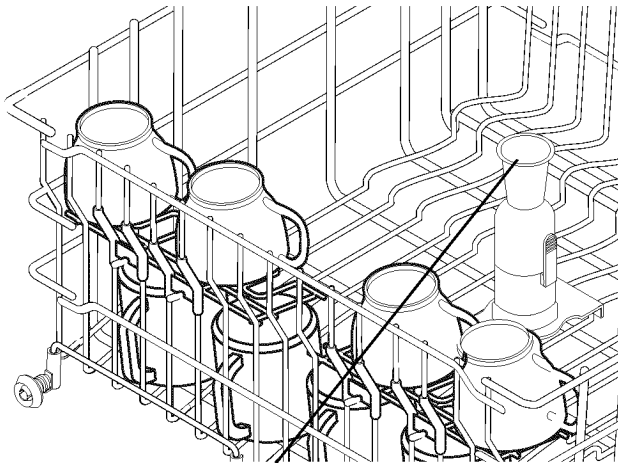

Do not cover funnel

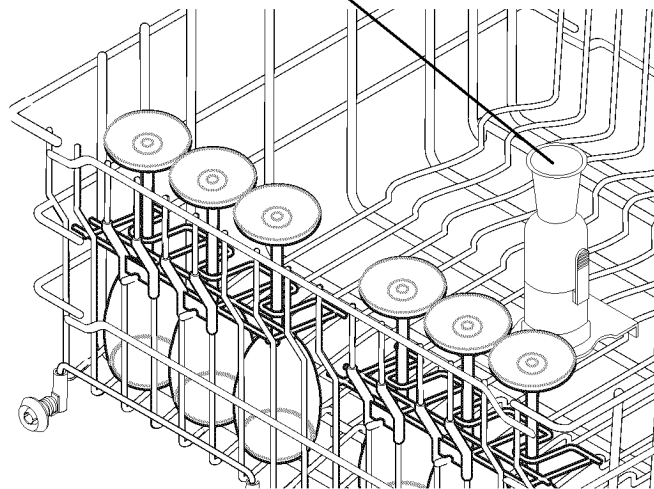

Fold-down Tines (on some models)

The fold-down tines on the right side of the top rack can be adjusted to make room for a variety of items.

To adjust the tines:

1. Grasp the tip of the tine that is in the tine holder.
2. Gently push the tine out of the holder.
3. Position the tine in any of the settings or lay down flat toward the center of the rack.

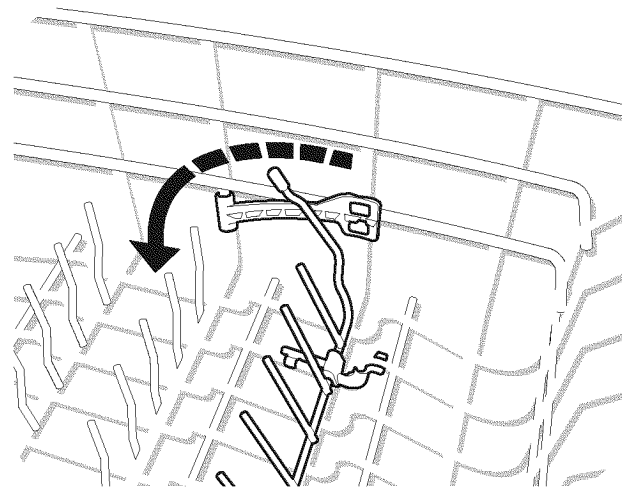

ENGLISH

Utility Basket

The utility basket has two dividers that can be opened to hold longer items or closed for small items like measuring spoons, bottle stoppers, etc. The covers on each end can be folded down out of the way or closed to keep small items inside.

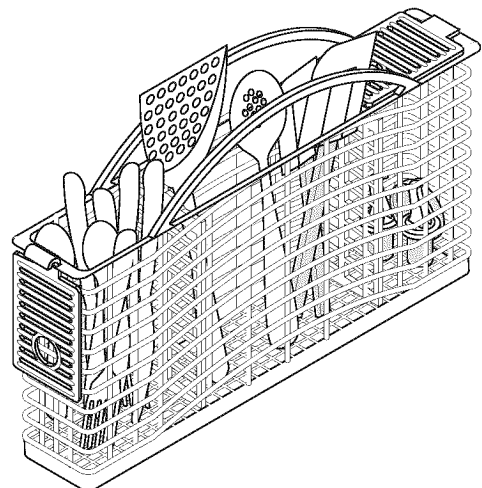

Preparing and Loading Dishes (continued)

Loading the Bottom Rack

Features and appearance of racks and silverware basket may vary from your model.

The bottom rack is best for plates, saucers, bowls, and cookware. Large items should be placed along the edge so they do not block the spray arm rotation. For best results, place bowls, casseroles, and sauce pans with soiled surface facing down or toward the center. Tilt slightly for better drainage.

Make sure tall items do not block spray arm rotation.

Be sure pan handles do not protrude through the bottom of the rack and block the spray arm rotation.

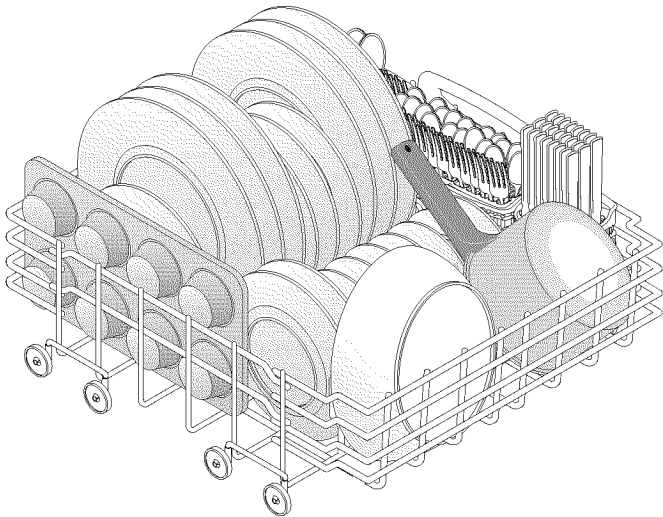

Fold-down Tines

You can fold down one or both rows of tines at the back of the bottom rack to make room for larger dishes, bowls, pots, pans or roasters.

- Grasp the tip of the tine and lay the row of tines down toward the back of the rack.

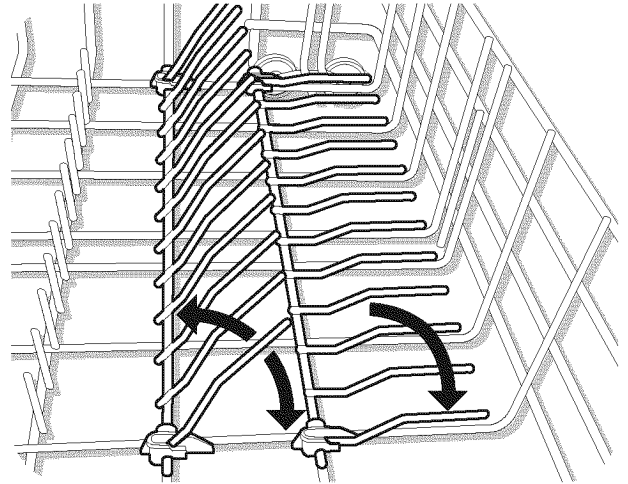

ENGLISH

Preparing and Loading Dishes (continued)

Loading the Silverware Basket

CAUTION

Cut Injury

Load sharp items (knives, skewers, etc.) pointing down.

Failure to do so may result in injury.

Load the silverware basket while it is in the bottom rack or take the basket out for loading on a counter or table.

Place small items like baby bottle caps, jar lids, corn cob holders, etc., in a covered section. Close the cover to hold small items in place.

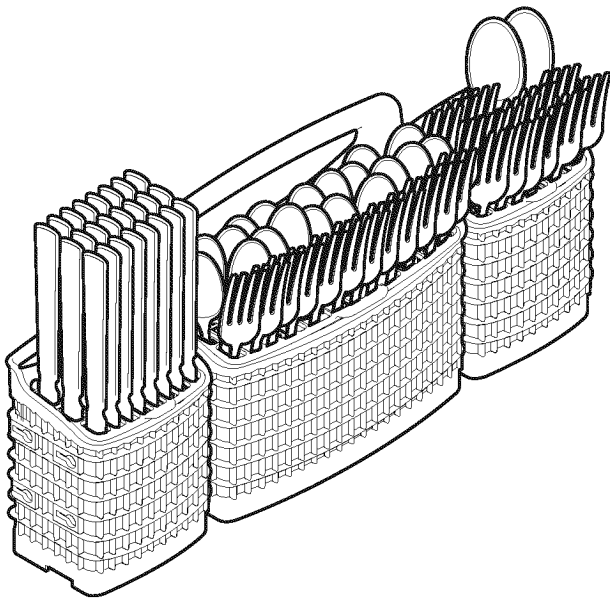

Use suggested loading patterns, as shown, to increase washability of your silverware.

Be sure nothing protrudes through bottom of basket or rack to block the spray arm.

Do not mix silver and stainless to avoid damaging the silver finish.

The silverware basket can be separated and placed in several locations in the bottom rack. Load silverware in all sections or just one, depending on your load.

When covers are up, mix items in each section of the basket with some pointing up and some down to avoid nesting. Water spray cannot reach nested items.

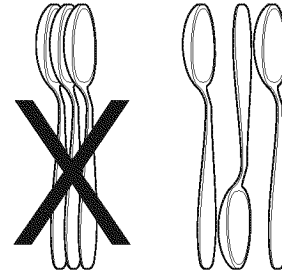

To remove small basket:

1. Hold the center basket and one small basket. Slide the small basket back to release the tabs from the corresponding slots.
2. Pull the baskets apart.

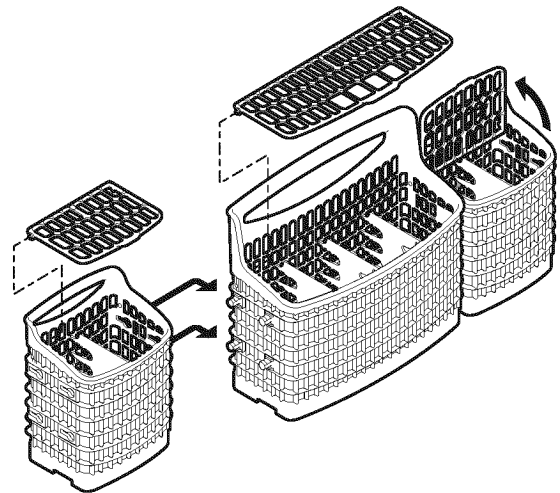

Adding a Dish

To add or remove items after wash cycle starts:

- Unlatch door and wait a few seconds until wash action stops before opening.
- Add the item and wait a few seconds to allow cold air to slowly expand inside dishwasher.
- Close door firmly to latch. Press START/CANCEL pad to resume cycle.

ENGLISH

Dishwasher Dispenser & Detergents

Filling the Detergent Dispenser

The detergent dispenser has one covered and one uncovered cup. Detergent in the uncovered cup falls into the dishwasher when the door is closed. The covered cup opens automatically to release detergent.

- Use only fresh automatic dishwashing detergent. Other detergents will cause oversudsing.
- Add detergent just before starting cycle.
- Store detergent in a cool, dry location. Moist or caked detergent will not dissolve properly.

How much Detergent to use

The amount of detergent to use depends on the water hardness. Water hardness is measured in grains per gallon. Using too little detergent can result in poor cleaning and hard water filming or spotting. Using too much detergent in soft water can cause a permanent film called etching. Your local water company, water softener company or county extension agent can tell you the water hardness in your area.

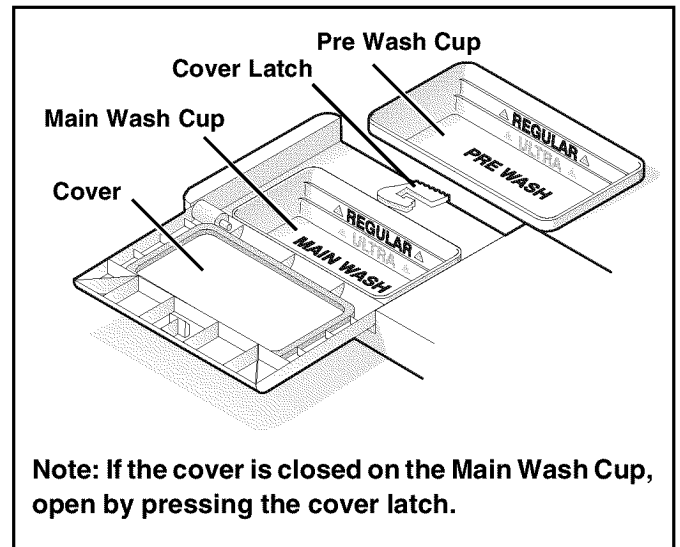

ENGLISH

Detergent Usage Guide				
Cycle	Soft Water (0-3 grains)	Medium Hard Water (4-8 grains)	Hard Water (9-12 grains)	Very Hard Water* (over 12 grains)
Pots Pans or Normal Wash	2 teaspoons (each cup— 1/4 full)	5 teaspoons (each cup—fill to line above "Regular")	8 teaspoons (each cup— completely full)	Each Cup— Completely Full (water softener recommended)
Light Wash or Water Miser	2 teaspoons (Main Wash cup— 1/4 full)	5 teaspoons (Main Wash cup—fill to line above "Regular")	8 teaspoons (Main Wash cup— completely full)	Main Wash Cup— Completely Full (water softener recommended)
Quick Rinse	No Detergent	No Detergent	No Detergent	No Detergent (water softener recommended)

*Note: For very hard water, detergent alone may not be enough. A water softener is recommended to improve water quality and dishwashing performance. Try adding more detergent at the beginning of the main wash portion of the cycle. As a rule, use 1 teaspoon for each grain above 12. Unlatch the door, open slowly and add detergent to the bottom of the tub. Close the door to latch and the dishwasher will continue through the cycle.

Dishwasher Dispenser & Detergents (continued)

Rinse Aid

Rinse aid greatly improves drying and reduces water spots and filming. Water "sheets" off dishes rather than forming water droplets that cling and leave spots.

A dispenser, located next to the detergent cup, automatically releases a measured amount of rinse aid during the last rinse. If spotting and poor drying are problems, increase the amount of rinse aid dispensed by rotating the dial to a higher number. The dial is located under the dispenser cap. The indicator will be dark when full and will show clear when it is time to refill.

To add liquid rinse aid, turn dispenser cap 1/4 turn counterclockwise and lift out. Pour in rinse aid until liquid touches the indicated fill level. Replace cap.

Do not overfill since this can cause oversudsing. Wipe up any spills with a damp cloth.

The dispenser holds enough for 35 to 140 washes, depending on setting.

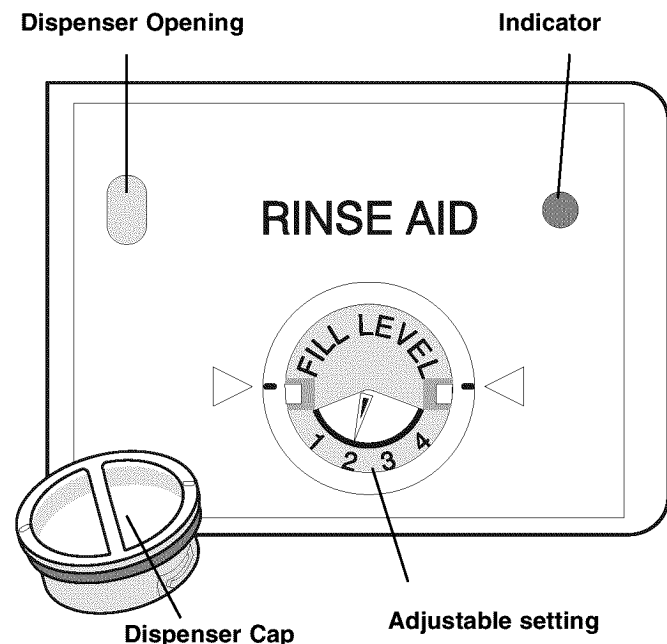

Factors Affecting Performance

Water Pressure

The hot water line to dishwasher must provide water pressure between 20 and 120 psi.

Low water pressure may occur when laundry or showers are in operation. Wait until water use is reduced before starting dishwasher.

Water Temperature

Hot water is needed for best dishwashing and drying results. Water entering dishwasher should be 120°F (49°C) to give satisfactory results.

To check water temperature entering dishwasher:

- Turn on hot water faucet nearest dishwasher for several minutes to clear cool water from pipes.
- Hold a candy or meat thermometer in stream of water to check the temperature.
- If temperature is below 120°F (49°C), have a qualified person raise the hot water heater thermostat setting.

Important: Before starting a cycle, run hot water to clear cool water from pipe.

Care and Cleaning

⚠ WARNING	
	Burn Hazard Allow heating element to cool before cleaning the interior. Failure to do so can result in burns.

Outside—Occasionally wipe with a mild nonabrasive detergent and water. Rinse and dry.

Models with Stainless Steel Door—Clean stainless steel with hot, soapy water and a dishcloth. Rinse with clean water and a cloth. Do not use harsh scrubbing cleaners. Use only kitchen cleaners made especially for cleaning stainless steel.

Inside—The inside of the dishwasher is self-cleaning with normal use. If needed, clean around the tub gasket area with a damp cloth.

The filter is self-cleaning. A glass trap located in the center of the filter is designed to collect pieces of broken glass, straws, bones and pits. To remove items in glass trap, grasp handle, lift out, empty and replace.

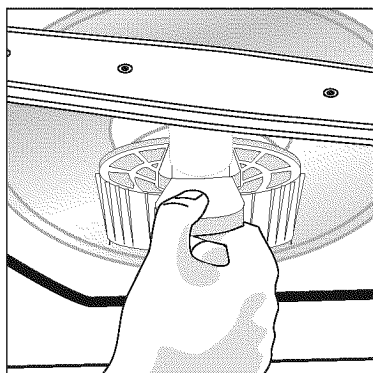

Note: Hard water may cause lime deposit buildup on the interior of the dishwasher. For cleaning instructions see “Removing Spots and Film” section.

Overfill Protector—keeps dishwasher from overfilling and is located in the left front corner of the tub.

- Clean occasionally with household cleaner containing vinegar or bleach to dissolve any buildup.
- Overfill Protector should move up and down freely about one inch. If it does not move, lift and clean underneath.

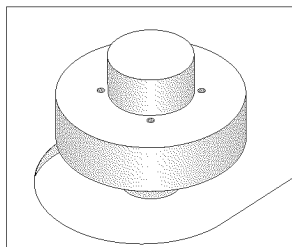

Care of Drain Air Gap

If a drain air gap was installed for your built-in dishwasher, check to make sure it is clean so the dishwasher will drain properly. A drain air gap is usually mounted on countertop and can be inspected by removing the cover. This is not part of your dishwasher and is not covered by warranty.

⚠ CAUTION
Property Damage Hazard Freezing temperatures may cause water lines to rupture. Be sure all supply lines to and circulating lines within dishwasher are protected. Failure to do so could result in property damage.

Winterizing

A dishwasher left in an unheated place should be protected from freezing. Have a qualified person do the following:

To Disconnect Service:

1. Turn off electrical power to the dishwasher at the supply source by removing fuses or tripping circuit breaker.
2. Shut off water supply.
3. Place a pan under the inlet valve. Disconnect water line from inlet valve and drain into pan.
4. Disconnect drain line from pump and drain water into pan.

Note: See Installation Instructions for more details.

To Restore Service:

1. Reconnect the water, drain and electrical power supply.
2. Turn on water and electrical power supply.
3. Fill both detergent cups and run dishwasher through a POTS PANS cycle.
4. Check connections to make sure they do not leak.

Note: See Installation Instructions for more details.

Solutions to Common Dishwashing Problems

Before calling for service, review this list. It may save you both time and expense. This list includes common experiences that are not the result of defective workmanship or material in your dishwasher.

Food Soils Left on Dishes

- Choose another cycle for longer washing time.
- Check rack loading section for proper loading—avoid nesting items.
- Home water pressure may be too low—should be 20 to 120 pounds per square inch (psi).
- Check incoming water temperature. It should be 120°F (49°C). (See Factors Affecting Performance.)
- Check water hardness. For extremely hard water, it may be necessary to install a water softener. (See Detergent Chart.)
- Use fresh detergent.
- Check to make sure funnel in top rack is not blocked.
- Make sure items are not blocking the spray arms, preventing them from rotating.

Dishes not Dry

- Select heat dry option.
- Make sure the rinse aid dispenser is filled.
- Increase the amount of rinse aid. (See Rinse Aid.)
- Check the incoming water temperature. It should be 120°F (49°C).
- Check for proper loading—avoid nesting items.
- Plastic items may need to be towel dried.
- Cups with a concave bottom will collect water.

Glassware/Flatware Spotted or Cloudy

- Check water hardness. For extremely hard water, it may be necessary to install a water softener. (See Dishwasher Dispenser & Detergents.)
- Water temperature may be low. Avoid extremely low or high temperatures. (See Factors Affecting Performance.)
- Avoid overloading and improper loading. (See Preparing and Loading Dishes.)
- Use fresh detergent. Old detergent is ineffective.
- Make sure rinse aid dispenser is filled.
- Check to see that proper amount of detergent is being used for cycle selected. Also, check phosphate level. (See Detergent Usage Guide.)
- Home water pressure may be too low—it should be 20 to 120 pounds per square inch (psi).

Dishware Chipped

- Load with care and do not overload. (See Preparing and Loading Dishes.)
- Place delicate items in top rack.
- Place glasses securely against pins and not over pins.
- Load items so they are secure and don't jar loose when moving racks in and out. Move racks in and out slowly.
- Make sure tall glasses and stemware will clear top of tub when rack is pushed in.
- Fine antique china and crystal should be hand-washed.

Dishware Stained or Discolored

- Tea and coffee can stain cups. Remove the stains by hand washing in a solution of 1/2 cup (120 ml) bleach and one quart (1 L) of warm water. Rinse thoroughly.
- Iron deposits in water can cause a yellow or brown film. A special filter installed in the water supply line will correct this problem. (See Removing Spots and Film.)
- Aluminum utensils can leave gray/black marks when they rub against other items. Load properly.
- Certain high acid foods can cause discoloration of stainless steel and plastics if allowed to sit for a long period. Use the QUICK RINSE cycle or rinse by hand if not operating dishwasher at once.
- Mixing stainless steel and silver utensils in silverware basket can cause pitting of the stainless steel blades. Avoid mixing stainless steel and silver.

Etching

- Using too much detergent in soft or softened water causes this film that cannot be removed.
- Adjust the amount of detergent based on the water hardness. (Check Detergent Usage Guide.)
- Lower the water temperature.
- Use the AIR DRY option.

Solutions to Common Dishwashing Problems (continued)

Detergent Left in Cups

- Detergent may be old. Discard and use fresh detergent.
- Be sure water action can reach the dispenser.
- Check to see if cycle has been completed.
- Make sure items do not prevent the detergent dispenser from opening.

Dishwasher Leaks

- Use only fresh detergent designed for automatic dishwashers. Measure detergent carefully. Try a different brand.
- Spilled rinse aid can cause foam and lead to overflowing. Wipe up any spills with a damp cloth.
- Check to see that dishwasher is level.
(See Installation Instructions.)

Normal Sounds You Will Hear

- Normal sounds include water fill, water circulation and motor sounds.
- There is a noticeable change in sound when the wash action switches between the lower and middle spray arm. This is normal since each spray arm has its own sound.
- It is normal for dishwasher to pause (no sound) when the wash action is switching between the lower and middle spray arms.

Water in Bottom of Tub

- Water left in bottom of tub after cycle is complete is not normal. If water remains in the bottom of the tub, dishwasher may not be draining properly. (See Dishwasher Does Not Drain Properly.)

Vapor at Vent

- Water vapor escapes from the vent during the drying part of cycle. This is normal.

Dishwasher Won't Run

- Check to see if circuit breaker is tripped or if a fuse is blown.
- Make sure water supply is turned on.
- Check to see if cycle is set correctly.
(See Operating Instructions.)
- Is dishwasher set for delay start option?
- Make sure door is closed and latched.

Dishwasher Does Not Drain Properly

- If unit is hooked up to a food waste disposer, make sure the disposer is empty.
- Check to see if the knockout plug has been removed from inside the food waste disposer inlet.
- Check to see if drain hose is kinked.
- Make sure cycle is complete, not in a pause.

Cycle Takes a Long Time

- Is cycle in a water heating delay?
- Has the delay start option been selected?
- Has the SANITIZE option been selected?

Dishwasher Won't Fill

- Is water supply turned on?
- Does overflow protector move up and down freely?
(See Overflow Protector section.)

Dishwasher Has an Odor

- Soiled dishes left in dishwasher too long can create an odor. Use the QUICK RINSE cycle.
- There will be a "new" smell when first installed. This is normal.
- Check to see if unit is draining properly. (See Dishwasher Does Not Drain Properly.)

Stains on Tub Interior

- Washing large amounts of dishware with tomato based soil can cause a pink/orange appearance. This will not affect performance and will gradually fade over time. Pre-rinsing or using the QUICK RINSE cycle will reduce the chance of staining. Using the AIR DRY option will lessen staining.

Solutions to Common Dishwashing Problems (continued)

Removing Spots and Film

Hard water can cause lime deposit buildup on the interior of the dishwasher. Dishes and glasses may also get spots and film for a number of reasons. (See Glassware/Flatware Spotted or Cloudy section.) To remove buildup, spots and film, clean using the following instructions:

1. Load clean dishes and glasses in normal manner. Do not load any metal utensils or silverware.
2. Do not add detergent.
3. Select the NORMAL WASH cycle. Close and latch door. Press START/CANCEL pad.
4. Allow dishwasher to run until it starts the second water fill (approximately 10 minutes). The SENSING light will be off.
5. Unlatch and open door and pour 2 cups of white vinegar into the bottom of dishwasher.
6. Close and latch door and allow cycle to finish.

Note: If these conditions persist, a home water softener should be considered.

To customize your dishwasher to match your cabinets:

- You will need a trim kit.
- See Step 10 of Installation Instructions that came with your dishwasher for more information.

Get it fixed, at your home or ours!

Your Home

For repair – **in your home** – of **all** major brand appliances, lawn and garden equipment, or heating and cooling systems, **no matter who made it, no matter who sold it!**

For the replacement parts, accessories and owner's manuals that you need to do-it-yourself.

For Sears professional installation of home appliances and items like garage door openers and water heaters.

1-800-4-MY-HOME® (1-800-469-4663)

Call anytime, day or night (U.S.A. and Canada)

www.sears.com

www.sears.ca

Our Home

For repair of carry-in products like vacuums, lawn equipment, and electronics, call or go on-line for the location of your nearest **Sears Parts & Repair Center.**

1-800-488-1222

Call anytime, day or night (U.S.A. only)

www.sears.com

To purchase a protection agreement on a product serviced by Sears:

1-800-827-6655 (U.S.A.)

1-800-361-6665 (Canada)

Para pedir servicio de reparación a domicilio, y para ordenar piezas:

1-888-SU-HOGARSM

(1-888-784-6427)

Au Canada, pour service en français:

1-800-LE-FOYER^{MC}

(1-800-533-6937)

www.sears.ca



Free Manuals Download Website

<http://myh66.com>

<http://usermanuals.us>

<http://www.somanuals.com>

<http://www.4manuals.cc>

<http://www.manual-lib.com>

<http://www.404manual.com>

<http://www.luxmanual.com>

<http://aubethermostatmanual.com>

Golf course search by state

<http://golfingnear.com>

Email search by domain

<http://emailbydomain.com>

Auto manuals search

<http://auto.somanuals.com>

TV manuals search

<http://tv.somanuals.com>