



Dishwasher

Use & Care Guide

Lavavajillas

Manual de uso y cuidado

Lave-vaisselle

Guide d'utilisation et de maintenance

Models/Modelos/Modèles 665.16652, 665.16654, 665.16659

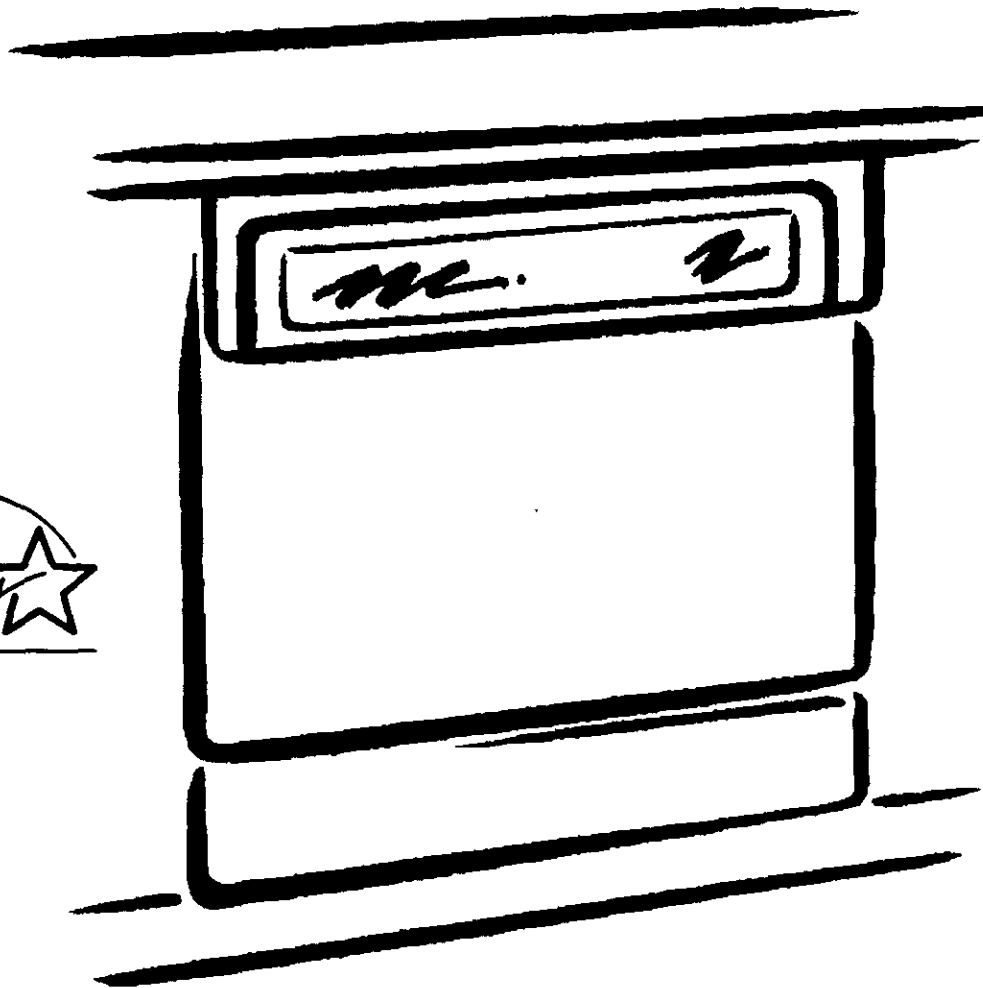

LIBRARY:

Received _____

Copied _____

Entered _____

7/18/07

U.S. NRPDS _____

Received 2/21

Scanned _____

Batch # _____

Energy Star

ESPAÑOL FRANÇAIS

TABLE OF CONTENTS

WE SERVICE WHAT WE SELL	2
WARRANTY	3
DISHWASHER SAFETY	4
Before Using Your Dishwasher	5
PARTS AND FEATURES	6
Soil Removal System	7
START-UP GUIDE	7
Using Your New Dishwasher	7
DISHWASHER LOADING	8
Loading Suggestions	8
Loading the Top Rack	8
Loading the Bottom Rack	9
Loading the Silverware Basket	9
DISHWASHER USE	10
Detergent Dispenser	10
Rinse Aid Dispenser	11
Dishwasher Efficiency Tips	11
Control Panel	12
Cycle Selection Chart	12
Canceling a Cycle	13
Changing a Cycle or Setting	13
Adding Items During a Cycle	13
Option Selections	13
Cycle Status Indicators	14
Drying System	14
Overfill Protection Float	14
WASHING SPECIAL ITEMS	14
DISHWASHER CARE	15
Cleaning Your Dishwasher	15
Drain Air Gap	16
Storing Your Dishwasher	16
TROUBLESHOOTING	16

WE SERVICE WHAT WE SELL

"We Service What We Sell" is our assurance that you can depend on Sears for service. Your dishwasher has added value when you consider that Sears has service units nationwide, staffed with professional technicians specifically trained on Sears appliances and having the parts, tools, and equipment to ensure that we meet our pledge to you... "We Service What We Sell."

Maintain the value of your KENMORE® Dishwasher with a Sears Maintenance Agreement. Sears dishwashers are designed, manufactured, and tested for years of dependable operation. Yet any modern appliance may require service from time to time.

The Sears Maintenance Agreement

- Is your way to buy tomorrow's service at today's prices.
- Eliminates repair bills resulting from normal use.
- Allows for as many service calls as required.
- Provides for service by professional Sears Trained Technicians.
- Even if you don't need repairs, the Maintenance Agreement offers an annual preventative maintenance check-up at your request!

This Maintenance Agreement does not cover original installation, or damage resulting from external causes such as acts of abuse, theft, fire, flood, wind, lightning, freezing, power failure, power reduction, etc.

WARRANTY

FULL ONE-YEAR WARRANTY ON KENMORE DISHWASHERS

For one year from the date of purchase, when this dishwasher is installed and operated according to instructions provided in the Installation Instructions and Use & Care Guide, Sears will repair this dishwasher, free of charge, if defective in material or workmanship.

FULL WARRANTY FOR THE LIFE OF THE DISHWASHER, ON ULTRA LIFE™ TUB MODELS, AGAINST LEAKS IN THE TUB AND INNER DOOR PANEL

For the life of the dishwasher, if a leak should occur as a result of failure of the polypropylene tub or inner door panel due to cracking, chipping or peeling, Sears will replace free of charge the tub or inner door panel.

WARRANTY RESTRICTION

If the dishwasher is subject to other than private family use, the above warranty coverage is effective for only 90 days.

WARRANTY SERVICE

WARRANTY SERVICE IS AVAILABLE BY CONTACTING THE NEAREST SEARS SERVICE CENTER IN THE UNITED STATES OR CANADA. This warranty applies only while the product is in use in the United States or Canada. This warranty gives you specific legal rights and you may also have other rights which vary from state to state or province to province.

Warranty terms may vary in Canada.

For Sears Warranty information in the United States or Canada call 1-800-469-4663.

**Sears, Roebuck and Co.
D/817WA, Hoffman Estates, IL 60179**

**Sears Canada, Inc.
Toronto, Ontario, Canada M5B 2B8**

In the space below, record your complete model number, serial number, and purchase date. You can find this information on the model and serial number label, located as shown in the Parts and Features section of this book. Have this information available to help you quickly obtain assistance or service when you contact Sears concerning your appliance.

Model number **665**, _____
Serial number _____
Purchase date _____

Save these instructions and your sales receipt for future reference.

DISHWASHER SAFETY

Your safety and the safety of others are very important.

We have provided many important safety messages in this manual and on your appliance. Always read and obey all safety messages.



This is the safety alert symbol.

This symbol alerts you to potential hazards that can kill or hurt you and others.

All safety messages will follow the safety alert symbol and either the word "DANGER" or "WARNING." These words mean:

⚠ DANGER

You can be killed or seriously injured if you don't immediately follow instructions.

⚠ WARNING

You can be killed or seriously injured if you don't follow instructions.

All safety messages will tell you what the potential hazard is, tell you how to reduce the chance of injury, and tell you what can happen if the instructions are not followed.

IMPORTANT SAFETY INSTRUCTIONS

WARNING: When using the dishwasher, follow basic precautions, including the following:

- Read all instructions before using the dishwasher.
- Use the dishwasher only for its intended function.
- Use only detergents or rinse agents recommended for use in a dishwasher, and keep them out of the reach of children.
- When loading items to be washed:
 - 1) Locate sharp items so that they are not likely to damage the door seal; and
 - 2) Load sharp knives with the handles up to reduce the risk of cut-type injuries.
- Do not wash plastic items unless they are marked "dishwasher safe" or the equivalent. For plastic items not so marked, check the manufacturer's recommendations.
- Do not touch the heating element during or immediately after use.
- Do not operate the dishwasher unless all enclosure panels are properly in place.
- Do not tamper with controls.
- Do not abuse, sit on, or stand on the door or dish racks of the dishwasher.
- To reduce the risk of injury, do not allow children to play in or on the dishwasher.
- Under certain conditions, hydrogen gas may be produced in a hot water system that has not been used for two weeks or more. **HYDROGEN GAS IS EXPLOSIVE.** If the hot water system has not been used for such a period, before using the dishwasher turn on all hot water faucets and let the water flow from each for several minutes. This will release any accumulated hydrogen gas. As the gas is flammable, do not smoke or use an open flame during this time.
- Remove the door to the washing compartment when removing an old dishwasher from service or discarding it.

SAVE THESE INSTRUCTIONS

Before Using Your Dishwasher

⚠ WARNING



Tip Over Hazard

Do not use dishwasher until completely installed.

Do not push down on open door.

Doing so can result in serious injury or cuts.

⚠ WARNING



Electrical Shock Hazard

Electrically ground dishwasher.

Connect ground wire to green ground connector in terminal box.

Do not use an extension cord.

Failure to follow these instructions can result in death, fire, or electrical shock.

- Install where dishwasher is protected from the elements. Protect against freezing to avoid possible rupture of fill valve. Such ruptures are not covered by the warranty. See "Storing Your Dishwasher" in the "Dishwasher Care" section for winter storage information.
- Install and level dishwasher on a floor that will hold the weight, and in an area suitable for its size and use.
- Remove all shipping plugs from hoses and connectors (such as the cap on the drain outlet) before installing. See Installation Instructions for complete information.

GROUNDING INSTRUCTIONS

- **For a grounded, cord-connected dishwasher:**
The dishwasher must be grounded. In the event of a malfunction or breakdown, grounding will reduce the risk of electric shock by providing a path of least resistance for electric current. The dishwasher is equipped with a cord having an equipment-grounding conductor and a grounding plug. The plug must be plugged into an appropriate outlet that is installed and grounded in accordance with all local codes and ordinances.

WARNING: Improper connection of the equipment-grounding conductor can result in a risk of electric shock. Check with a qualified electrician or service representative if you are in doubt whether the dishwasher is properly grounded. Do not modify the plug provided with the dishwasher; if it will not fit the outlet, have a proper outlet installed by a qualified electrician.

- **For a permanently connected dishwasher:**
The dishwasher must be connected to a grounded metal, permanent wiring system, or an equipment-grounding conductor must be run with the circuit conductors and connected to the equipment-grounding terminal or lead on the dishwasher.

SAVE THESE INSTRUCTIONS

PARTS AND FEATURES

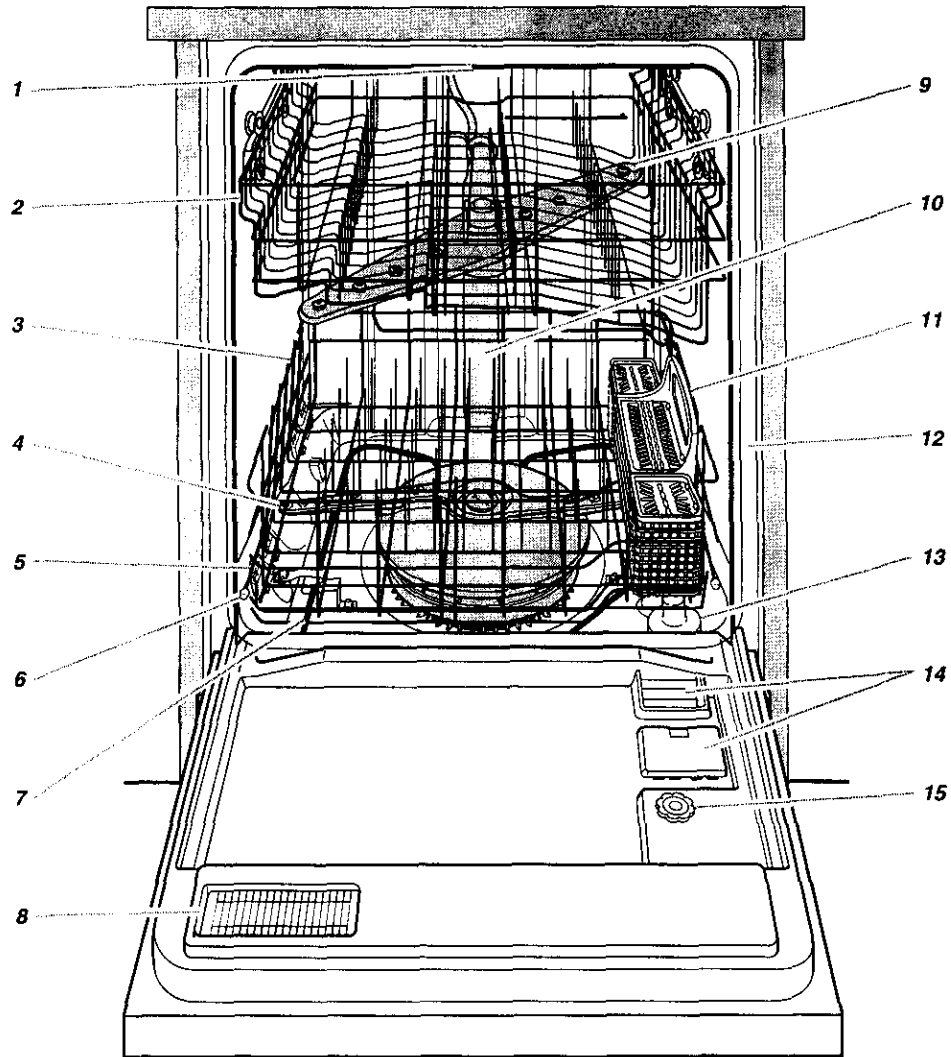

- | | | |
|--------------------------------------|---------------------------------|-----------------------------------|
| 1. Upper level wash | 6. Rack bumper | 11. Silverware basket |
| 2. Top rack | 7. Heating element | 12. Model and serial number label |
| 3. Bottom rack | 8. Vent | 13. Overfill protection float |
| 4. Lower spray arm | 9. Top spray arm | 14. Detergent dispenser |
| 5. Water inlet opening [in tub wall] | 10. ULTRA FLOW™ water feed tube | 15. Rinse aid dispenser |

Control Panel

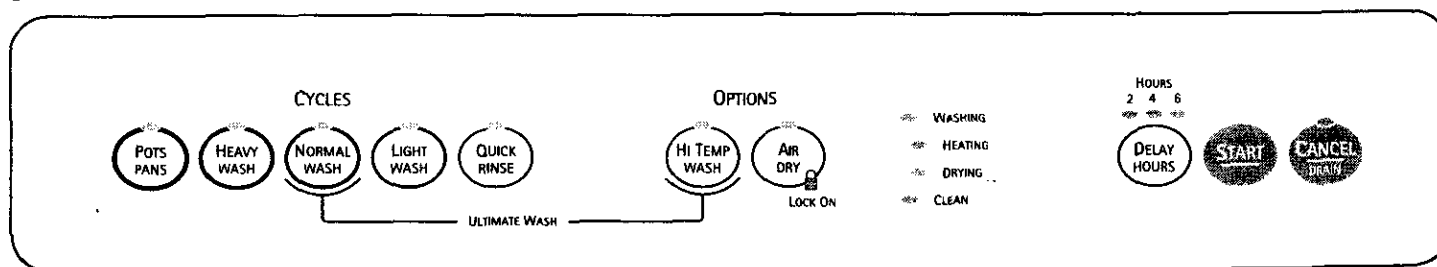

Soil Removal System

The soil removal system gives you sparkling clean dishes, while using less energy and time. The soil removal system includes:

A heavy-duty grinder that acts as a food disposer to grind and dispose of large food particles.

How the soil removal system works

1. Load the dishwasher. Remove bones, large chunks or burned-on food. No rinsing is necessary. Any remaining food soil will be ground up and disposed down the drain with the rinse water.
2. Hot water fills the dishwasher to a level near the bottom of the overflow protection float.
3. The Heating indicator glows and the dishwasher pauses while the water is heated.
4. When the water reaches the proper temperature, the Heating indicator turns off and the cycle countdown resumes.
5. Detergent from the detergent dispenser is dispensed at the correct cycle times and hot water is pumped through the pump.
6. Hot water and detergent sprays against the soiled surfaces of the load and removes food particles.
7. Food soil is held in an accumulating chamber.

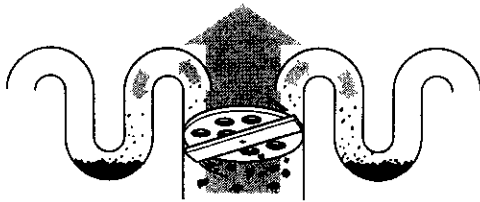

8. Food soil is disposed down the drain with the wash water.

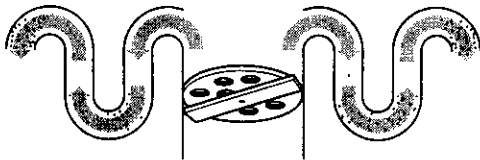

9. Fresh, hot water enters the dishwasher and sprays on the dishes. The rinse water is then pumped through the soil removal system and remaining soil is removed.
10. The food soil that is held in the soil removal system is disposed down the drain with the rinse water.
11. The final rinse water is heated. The rinse aid is added to the water for the final rinse to prepare the dishes for drying.

START-UP GUIDE

Before using your dishwasher, remove all packaging materials. Read this entire Use and Care Guide. You will find important safety information and useful operating tips.

Using Your New Dishwasher

1. Scrape large food soil and hard items (toothpicks or bones) from dishes.
2. Properly load the dishwasher. (See "Dishwasher Loading.") Make sure nothing prevents the spray arm(s) from spinning freely.

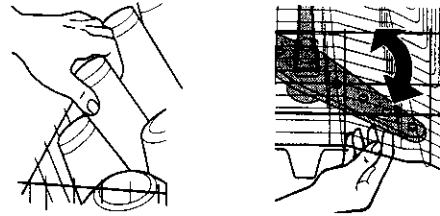

3. Add detergent and check the rinse aid dispenser. Add rinse aid if needed. (See "Dishwasher Use.")

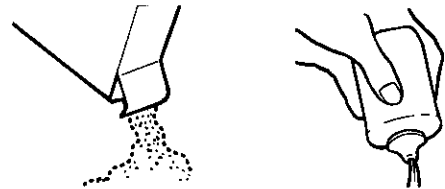

4. Push door firmly closed. The door latches automatically. Run hot water at the sink nearest your dishwasher until the water is hot. (See "Dishwasher Efficiency Tips.") Turn off water.

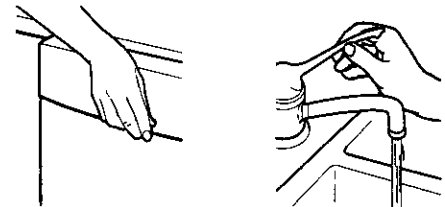

5. Press the desired cycle and option selections. (See "Dishwasher Use.") Press START.

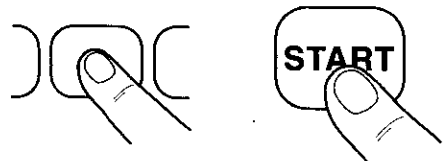

DISHWASHER LOADING

Loading Suggestions

- Remove leftover food, bones, toothpicks and other hard items from the dishes. It is not necessary to rinse the dishes before putting them in the dishwasher. The wash module removes food particles from the water. The module contains a chopping device which will reduce the size of food items.

NOTE: If hard items such as fruit seeds, nuts, and egg shells enter the wash module, you might hear chopping, grinding, crunching, or buzzing sounds. These sounds are normal when hard items enter the module. Do not let metallic items (such as pot handle screws) get into the wash module. Damage can occur.

- Load dishes so soiled surfaces face the spray (down or inward). It is important for the water spray to reach all soiled surfaces.
- Load dishes so they are not stacked or overlapping if possible. For best drying, water must be able to drain from all surfaces.
- Make sure pot lids and handles, pizza pans, cookie sheets, etc., do not interfere with the spray arm rotation.
- Run a rinse cycle to keep dishes moist if you do not plan to wash them soon. Foods like eggs, rice, pasta, spinach, and cooked cereals may be hard to remove if they are left to dry over a period of time.

Quiet operating tips

To avoid thumping/clattering noises during operation:

- Make sure lightweight load items are secured in the racks.
- Make sure pot lids and handles, pizza pans, cookie sheets, etc., do not touch interior walls or interfere with the rotation of the spray arm.
- Load dishes so they do not touch one another.

NOTE: For built-in models, keep sink drain plugs closed during dishwasher operation to prevent noise transfer through drains.

Loading the Top Rack

The top rack is designed for cups, glasses, and smaller items. (See recommended loading patterns shown.)

NOTE: The features on your dishwasher rack may vary from the drawings shown.

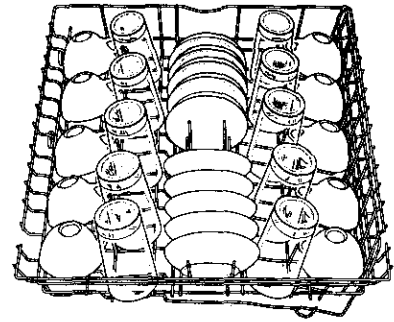

10 place setting

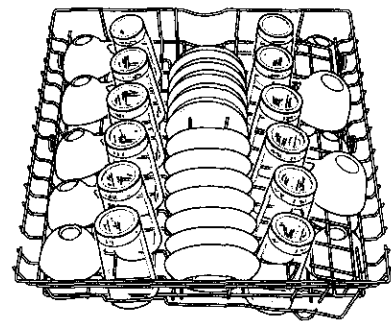

12 place setting

- Place items so open ends face down for cleaning and draining.
- Load glasses in top rack only. The bottom rack is not designed for glasses. Damage can occur.
- Place cups and glasses in the rows between tines. Placing them over the tines can lead to breakage and water spots.
- China, crystal, and other delicate items must not touch each other during dishwasher operation. Damage may occur.
- Load plastic items in the top rack only. Only plastic items marked "dishwasher safe" are recommended.
- Load plastic items so the force of the spray does not move them during the cycle.
- To avoid chipping, do not let stemware touch other items.
- Small bowls, pans, and other utensils can be placed in the top rack. Load bowls in the center section for best stability.

Loading the Bottom Rack

The bottom rack is designed for plates, pans, casseroles, and utensils. Items with cooked-on or dried-on food should be loaded with soiled surfaces facing inward to the spray. (See recommended loading patterns shown.)

NOTE: The features on your dishwasher rack may vary from the drawings shown.

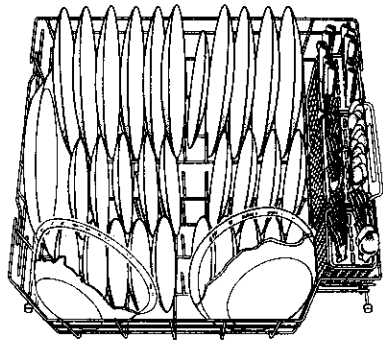

10 place setting

- Do not load glasses, cups, or plastic items in the bottom rack. Load small items in the bottom rack only if they are secured in place.
- Load plates, soup bowls, etc., between tines and facing inward to the spray.
- Overlap the edges of plates for large loads.
- Load soup, cereal, and serving bowls in the rack in a variety of ways depending upon their size and shape. Load bowls securely between the rows of tines. Do not nest bowls because the spray will not reach all surfaces.

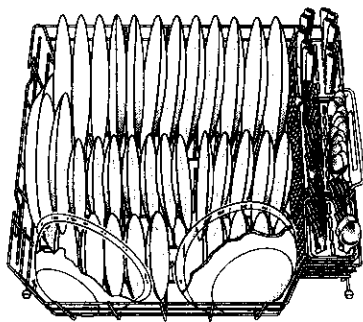

12 place setting

- Load cookie sheets, cake pans, and other large items at the sides and back. Loading such items in front can keep the water spray from reaching the detergent dispenser.
- Secure heavily soiled cookware face down in the rack.
- Make sure pot handles and other items do not stop rotation of the spray arm(s). The spray arm(s) must move freely.
- Do not load items between the bottom rack and the side of the dishwasher tub. You can block the water inlet opening.

NOTE: If you have removed the bottom rack for unloading or cleaning, replace it with the bumpers in front.

Loading the Silverware Basket

Load the silverware basket while it is in the bottom rack or take the basket out for loading on a counter or table.

NOTE: Unload or remove the basket before unloading the racks to avoid spilling water droplets on the silverware.

- Place small items like baby bottle caps, jar lids, corn cob holders, etc., in the covered section. Close the cover to hold small items in place.

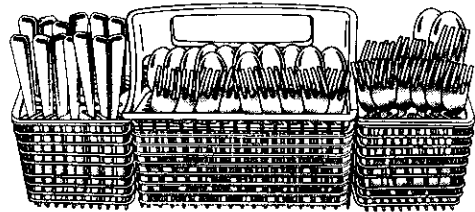

- This silverware basket can be separated and placed into the bottom rack in several locations. Load silverware in all sections or just one, depending upon your load.
- When covers are up, mix items in each section of the basket with some pointing up and some down to avoid nesting. Spray cannot reach nested items.

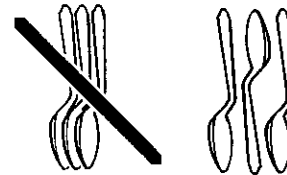

IMPORTANT: Always load sharp items (knives, skewers, etc.) pointing down.

To remove a small basket

1. Hold the center basket and one small basket. Slide the small basket forward to release the tabs from the corresponding slots.

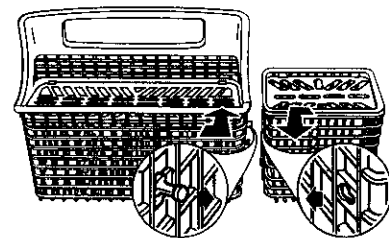

2. Pull the baskets apart.

NOTES:

- Do not load silver or silver-plated silverware with stainless steel. These metals can be damaged by contact with each other during washing.
- Some foods (such as salt, vinegar, milk products, fruit juices, etc.) can pit or corrode silverware. Run a rinse cycle if you do not have a full load to wash immediately.

DISHWASHER USE

Detergent Dispenser

The detergent dispenser has 2 sections. The Pre-Wash section empties detergent into the dishwasher when you close the door.

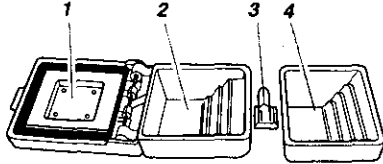

1. Cover
2. Main wash section
3. Cover latch
4. Pre-wash section (Do not use this section with the Normal Wash cycle.)

The larger Main Wash section automatically empties detergent into the dishwasher during the main wash. (See the "Cycle Selection Chart.")

- Use automatic dishwashing detergent only. Other detergents can produce excessive suds that can overflow out of the dishwasher and reduce washing performance.
- Add detergent just before starting a cycle.
- Store tightly closed detergent in a cool, dry place. Fresh automatic dishwasher detergent results in better cleaning.

NOTE: Do not use detergent with a rinse cycle.

Filling the dispenser

1. If the dispenser cover is closed, open the cover by pushing the Cover latch.
2. Fill the Main Wash section with detergent. See "How Much Detergent to Use."
3. Close the Main Wash dispenser cover. Fill the Pre-Wash section if needed.

It is normal for the cover to open partially when dispensing detergent.

NOTE: Use both sections for cycles with 2 washes. Use only the covered section for cycles with 1 wash. See the "Cycle Selection Chart" for more details.

How much detergent to use

- The amount of detergent to use depends on the hardness of your water and the type of detergent. If you use too little, dishes won't be clean. If you use too much in soft water, glassware will etch.
- Water hardness can change over a period of time. Find out your water's hardness by asking your local water department, water softener company, or county extension agent.
- Different brands of dishwasher detergent have different amounts of phosphorous for softening water. If you have hard water and use a detergent with a phosphorous content of less than 8.7%, you might need to use more detergent, or use a detergent with a phosphorous content higher than 8.7%.

Where to fill



Top of 3rd step (3 tbs or 45 g)



Top of 2nd step (2 tbs or 30 g)



Top of 1st step (1 tb or 15 g)

Water Hardness

Amount of Detergent

Soft to Medium Hard Water

0 to 6 grains per gallon

For normally soiled loads

- Fill the Main Wash section to the top of the 2nd step (2 tbs or 30 g)
- Fill the Pre-Wash section to the top of the 2nd step (2 tbs or 30 g) if needed

NOTE: Add only 1 tb or 15 g of detergent to both sections if dishes are pre-rinsed or the water is very soft (0 to 2 grains per gallon).

For heavily soiled loads

- Fill the Main Wash section to the top of the 3rd step (3 tbs or 45 g)
- Fill the Pre-Wash section to the top of the 2nd step (2 tbs or 30 g)

Medium to Hard Water

7 to 12 grains per gallon

For normally soiled and heavily soiled loads

- Fill the Main Wash section to the top of the 3rd step (3 tbs or 45 g)
- Fill the Pre-Wash section to the top of the 2nd step (2 tbs or 30 g) if needed

NOTE: Fill amounts shown are for standard powdered detergent. Amounts may vary if you use liquid or concentrated powdered detergent. Follow instructions on the package when using liquid dishwasher detergent or concentrated powdered detergent.

Rinse Aid Dispenser

Rinse aids prevent water from forming droplets that can dry as spots or streaks. They also improve drying by allowing water to drain off of the dishes during the final rinse by releasing a small amount of the rinse aid into the rinse water. Your dishwasher is designed to use a liquid rinse aid. Do not use a solid or bar-type.

Checking the dispenser

Check the center of the Fill Indicator cap. Clear means it needs filling.

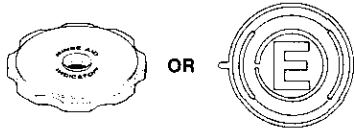

Or you can remove the Fill Indicator cap. If an "E" is visible, the dispenser is empty.

Filling the dispenser

The rinse aid dispenser holds 6 oz (175 mL) of rinse aid. Under normal conditions, this will last for about three months. You do not have to wait until the dispenser is empty to refill it. Try to keep it full, but be careful not to overfill it.

1. Make sure the dishwasher door is completely open.
2. Remove the Fill Indicator cap.
3. Add rinse aid. Fill to the smallest opening in the lower part of the dispenser. Overfilling can cause the rinse aid to leak out, and could cause oversudsing.

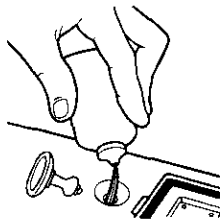

4. Clean up any spilled rinse aid with a damp cloth.
5. Replace the Fill Indicator cap. Close tightly.

Dishwasher Efficiency Tips

Hot water dissolves and activates the dishwashing detergent. Hot water also dissolves grease on dishes and helps glasses dry spot-free. For best dishwashing results, water must be at least 120°F (49°C) as it enters the dishwasher. Loads may not wash as well if the water temperature is too low.

To check water temperature

1. Run hot water at the faucet closest to your dishwasher for at least 1 minute.
2. Place a candy or meat thermometer in a glass measuring cup.

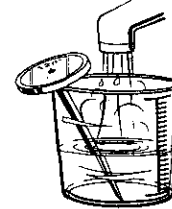

3. Check the temperature on the thermometer as the water is running into the cup.
4. If the water temperature at the faucet is below 120°F (49°C), have a qualified person raise the water heater's thermostat setting.
 - To save water and energy, do not rinse dishes before putting them into the dishwasher.
 - Use the Normal cycle whenever possible. This cycle uses less hot water and energy than other cycles.
 - Use a delay feature (on some models) to run your dishwasher during off-peak hours. Local utilities recommend avoiding heavy usage of energy at certain times of day.
 - During the summer, run your dishwasher at night. This reduces daytime heat buildup in the kitchen.
 - Use an air dry, or an energy-saving dry option whenever possible. Allow longer drying times (overnight) when using these options. Use a rinse aid to improve drying.
 - Use cycles or options that add extra heat to the wash or rinse portion of the cycle only when needed.
 - Run your dishwasher with full loads. Run a rinse cycle after meals until the dishwasher is full.

Control Panel

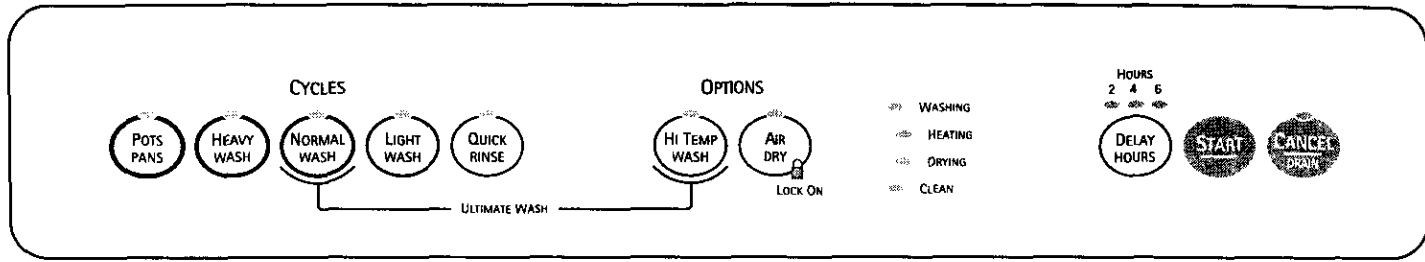

Cycle Selection Chart

Select the wash cycle and options desired. Or press START to use the same cycle and options as the previous cycle.

NOTE: If the last cycle you completed was a rinse cycle, the dishwasher will run the last full wash cycle and options that you selected when you press Start.

- If the power is off or the door is open for an extended period of time, the Start button memory will default to the Normal cycle with heated drying.
- If you do not run the dishwasher daily, close the door to maintain memory.

A "●" shows what steps are in each cycle.

Temperatures indicate where extra heat is added.

Water usage is shown in U.S. gallons/liters.

This model meets the ENERGY STAR® guidelines for energy efficiency.

Cycle time includes dry time. An asterisk (*) by the cycle time indicates the cycle time might be longer depending on the temperature of the water entering the dishwasher. The cooler the water, the longer the cycle time. If the water is already hot enough, the cycle time will be as shown.

POTS PANS

Use this cycle for hard-to-clean, heavily-soiled pots, pans, casseroles, and regular tableware.

Use both detergent dispenser sections.

Wash	Main Wash	Rinse	Rinse	Dry	Time (min)	Water Usage (gal/L)
● 135°F (57°C)	● 140°F (60°C)	●	● 135°F (57°C)	●	87*	9.1/34.4

HEAVY WASH

Use this cycle for loads with heavy food soil.

Use both detergent dispenser sections.

Wash	Main Wash	Rinse or Purge	Rinse	Dry	Time (min)	Water Usage (gal/L)
●	●	●	● 140°F (60°C)	●	72*	6.7/25.4

NORMAL WASH

Use this cycle for loads with normal amounts of food soil. (The energy-usage label is based on this cycle.)

Use covered detergent dispenser section.

Wash	Main Wash	Rinse or Purge	Rinse	Dry	Time (min)	Water Usage (gal/L)
	●	●	● 140°F (60°C)	●	62*	4.6/17.4

LIGHT WASH

Use this cycle for china and crystal. This cycle uses a light wash and gentle dry. During the heated dry, the heating element cycles on and off.

Use covered detergent dispenser section.

Wash	Main Wash	Rinse or Purge	Rinse	Dry	Time (min)	Water Usage (gal/L)
	●	●	● 130°F (54°C)	● cycled	58*	4.8/18.2

QUICK RINSE

Use this rinse cycle for rinsing dishes, glasses, and silverware that will not be washed right away.

Do not use detergent with this cycle.

Wash	Main Wash	Rinse	Rinse	Dry	Time (min)	Water Usage (gal/L)
			●		10	2.2/8.3

Canceling a Cycle

Anytime during a cycle, press



CANCEL/DRAIN glows. The dishwasher pauses for about 5 seconds and starts a 2 minute drain (if needed). Let the dishwasher drain completely. The light goes off when the dishwasher finishes the drain.

To stop the drain

You can press Cancel/Drain again to stop the drain immediately. Remember to drain the dishwasher before starting a new cycle.

NOTE: A small amount of water remains in the dishwasher. This is normal.

To clear the indicators

Press Cancel/Drain before starting the dishwasher to clear all options and cycles.

Changing a Cycle or Setting

During the first minute of a cycle

Press a new cycle and/or options.

After the first minute of a cycle

1. Press



CANCEL/DRAIN glows. The dishwasher pauses for 5 seconds and starts a 2 minute drain (if needed). Let the dishwasher drain completely.

2. Check the detergent dispensers. If the main wash cup has opened and the detergent washed away, refill the cups as needed.
3. Close the door.
4. Press a new cycle and/or options.
5. Press START.

Adding Items During a Cycle

You can add an item anytime before the main wash starts. Open the door and check the detergent dispenser. If the main wash section is still closed, you can add items.

To add items

1. Lift up the door latch to stop the cycle. Wait for the spraying action to stop before opening the door.
2. Open the door. If the main wash detergent dispenser is still closed, add the item.
3. Close the door, but do not latch it. Wait 30 seconds for the air in the dishwasher to warm up. This reduces the amount of moisture escaping from the vent when restarting a cycle.
4. Close the door firmly until it latches. The dishwasher resumes the cycle after about a 5 second pause.

Option Selections

You can customize your cycles by pressing an option. If you change your mind, press the option again to turn the option off. Select a different option if desired.

You can change an option anytime before the selected option begins. For example, you can press an unheated drying option any time before drying begins.

Press START to use the same cycle and option(s) as the previous wash cycle.

NOTE: If the last cycle you completed was a rinse cycle, when you press Start, the dishwasher runs the last full wash cycle and options.

Hi Temp Wash

Select this option to heat the water to 140°F (60°C) during parts of the cycle. Heating the water helps improve washing results. This option adds both heat and wash time to parts of the cycle. Hi Temp Wash is useful when loads contain baked-on food.



NOTES:

- Pots Pans automatically uses this option. Hi Temp Wash is an option with the Heavy Wash, Normal Wash and Light Wash cycles.
- Use this option for heavier than normal-soiled loads.

Air Dry

Select this energy-saving option to dry without heat. Air drying is useful when loads contain plastic dinnerware that may be sensitive to high temperatures.



The dishes take longer to dry and some spotting can occur. For best drying, use a liquid rinse aid. Some items (such as plastics) may need towel drying.

NOTE: Quick Rinse automatically use this option. Air Dry is an option with all other cycles.

Lock On

Use the Lock to prevent your dishwasher from accidentally being turned on. Use the Lock, also, to prevent accidental cycle or option changes during a cycle.



When LOCK ON is lit, all buttons are disabled.

NOTES:

- The dishwasher door can be opened while the controls are locked.
- You can turn on the Lock while the dishwasher is running.

To turn on the Lock
Press and hold



for 4 seconds. LOCK ON glows.

If you press any pad while your dishwasher is locked, the light flashes 3 times.

To turn off the Lock

Press and hold AIR DRY for 4 seconds. The light turns off.

Delay Hours

Select this option to run your dishwasher at a later time or during off-peak hours.

To delay the start

1. Close the door.
2. Select a wash cycle and options.
3. Press DELAY HOURS 1 time for a 2-hour delay, 2 times for a 4-hour delay, or 3 times for a 6-hour delay.



The number glows above Delay Hours. The dishwasher starts the cycle in the selected number of hours.

4. Press START.

NOTE: To cancel the delay, press CANCEL/DRAIN until all Delay Hours lights are off.

IMPORTANT:

- Operate your dishwasher only when you are at home.
- If your home is equipped with a water softener, do not start the dishwasher during the regeneration of the softener.

Cycle Status Indicators

Follow the progress of your dishwasher with the Cycle Status indicators.

- WASHING
- HEATING
- DRYING
- CLEAN

Heating

HEATING glows, and the cycle progression pauses, whenever water is heated during a cycle. Wash or rinse action continues as the water heats.

Clean

CLEAN glows when a cycle is finished. The light turns off when you open the door or press Cancel/Drain.

Drying System

During drying, you can see steam escaping through the vent at the upper left corner of the door. This is normal as the heat dries your dishes.

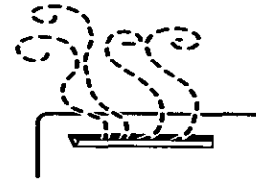

IMPORTANT: The vapor is hot. Do not touch the vent during drying.

Overfill Protection Float

The overfill protection float (in the front right corner of the dishwasher tub) keeps the dishwasher from overflowing. It must be in place for the dishwasher to operate.



Check under the float for objects that may keep the protector from moving up or down.

WASHING SPECIAL ITEMS

If you have doubts about washing a particular item, check with the manufacturer to see if it is dishwasher safe.

Material	Dishwasher Safe?/Comments
Aluminum	Yes High water temperature and detergents can affect finish of anodized aluminum.
Disposable Aluminum	No Do not wash throwaway aluminum pans in the dishwasher. These might shift during washing and transfer black marks to dishes and other items.
Bottles and Cans	No Wash bottles and cans by hand. Labels attached with glue can loosen and clog the spray arms or pump and reduce washing performance.
Cast Iron	No Seasoning will be removed and iron will rust.
China/ Stoneware	Yes Always check manufacturer's recommendations before washing. Antique, hand-painted, or over-the-glaze patterns may fade. Gold leaf can discolor or fade.

Material	Dishwasher Safe?/Comments
Crystal	Yes Check manufacturer's recommendations before washing. Some types of leaded crystal can etch with repeated washing.
Gold	No Gold-colored flatware will discolor.
Glass	Yes Milk glass yellows with repeated dishwasher washing.
Hollow-Handle Knives	No Handles of some knives are attached to the blade with adhesives which can loosen if washed in the dishwasher.
Pewter, Brass, Bronze	No High water temperatures and detergent can discolor or pit the finish.
Disposable Plastics	No Cannot withstand high water temperatures and detergents.
Plastics	Yes Always check manufacturer's recommendations before washing. Plastics vary in their capacity to withstand high temperatures and detergents. Load plastics in top rack only.
Stainless Steel	Yes Run a rinse cycle if not washing immediately. Prolonged contact with food containing salt, vinegar, milk products, or fruit juice can damage finish.
Sterling Silver or Silver Plate	Yes Run a rinse cycle if not washing immediately. Prolonged contact with food containing salt, acid, or sulfide (eggs, mayonnaise, and seafood) can damage finish.
Tin	No Can rust.
Wooden Ware	No Wash by hand. Always check manufacturer's instructions before washing. Untreated wood can warp, crack, or lose its finish.

DISHWASHER CARE

Cleaning Your Dishwasher

Cleaning the exterior

In most cases, regular use of a soft, damp cloth or sponge and a mild detergent is all that is necessary to keep the outside of your dishwasher looking nice and clean.

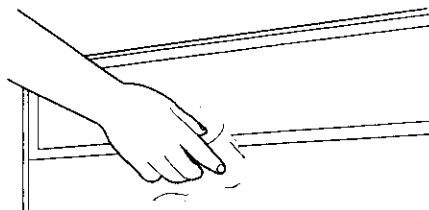

Cleaning the interior

Hard water minerals can cause a white film to build up on the inside surfaces, especially just beneath the door area.

Do not clean the dishwasher interior until it has cooled. Wear rubber gloves. **Do not** use any type of cleanser other than dishwasher detergent because it may cause foaming or sudsing.

To clean interior

Make a paste with powdered dishwasher detergent on a damp sponge and clean.

OR

Use liquid automatic dishwasher detergent and clean with a damp sponge.

OR

See the vinegar rinse procedure in "Spotting and filming on dishes" in "Troubleshooting."

NOTE: Run a Normal cycle with detergent after cleaning the interior.

Drain Air Gap

Check the drain air gap anytime your dishwasher isn't draining well.

Some state or local plumbing codes require the addition of a drain air gap between a built-in dishwasher and the home drain system. If a drain is clogged, the drain air gap protects your dishwasher from water backing up into it.

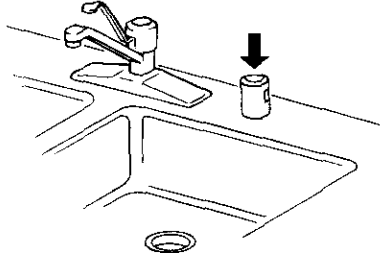

The drain air gap is usually located on top of the sink or countertop near the dishwasher. To order a drain air gap call 1-800-366-7278 and ask for Part Number 300096.

NOTE: The drain air gap is an external plumbing device that is not part of your dishwasher. The warranty provided with your dishwasher does not cover service costs directly associated with the cleaning or repair of the external drain air gap.

To clean the drain air gap

Clean the drain air gap periodically to ensure proper drainage of your dishwasher. Follow the cleaning instructions provided by the manufacturer. With most types, you lift off the chrome cover. Unscrew the plastic cap. Then check for any soil buildup. Clean if necessary.

Using Your Dishwasher

Storing for the summer

Protect your dishwasher during the summer months by turning off the water supply and power supply to the dishwasher.

Winterizing your dishwasher

Protect your dishwasher and home against water damage due to freezing water lines. If your dishwasher is left in a seasonal dwelling or could be exposed to near freezing temperatures, have your dishwasher winterized by authorized service personnel.

TROUBLESHOOTING

First try the solutions suggested here and possibly avoid the cost of a service call...

Dishwasher is not operating properly

■ Dishwasher does not run or stops during a cycle

Is the door closed tightly and latched?

Is the right cycle selected? Refer to the "Cycle Selection Chart."

Is there power to the dishwasher? Has a household fuse blown or circuit breaker tripped?

Has the motor stopped due to an overload? The motor automatically resets itself within a few minutes. If it does not restart, call for service.

Is the water shut-off valve (if installed) turned on?

■ Dishwasher will not fill

Is the overfill protection float able to move up and down freely? Press down to release.

■ Dishwasher seems to run too long

Is the water supplied to the dishwasher hot enough? The dishwasher runs longer while heating water. Refer to the "Water Temperature Tips" section.

A delay automatically occurs in some wash and rinse cycles until the water reaches the proper temperature.

■ Water remains in the dishwasher

Is the cycle complete?

■ Detergent remains in the covered section of the dispenser

Is the cycle complete?

Is the detergent lump-free? Replace detergent if necessary.

Is the bottom rack installed properly with the bumpers in the front? Refer to the "Parts and Features" section. Reinstall the rack if necessary.

■ White residue on the front of the access panel

Was too much detergent used? Refer to the "Detergent Dispenser" section.

Is the brand of detergent making excess foam? Try a different brand to reduce foaming and eliminate buildup.

■ Odor in the dishwasher

Are dishes washed only every 2 or 3 days? Run a rinse cycle once or twice a day until you have a full load.

Does the dishwasher have a new plastic smell? Run a vinegar rinse as described in "Spotting and filming on dishes" later in this Troubleshooting guide.

■ Condensation on the kitchen counter (built-in models)

Is the dishwasher aligned with the counter top? Moisture from the vent in the dishwasher console can form on the counter. Refer to the Installation Instructions for more information.

Dishes are not completely clean

■ Food soil left on the dishes

Is the dishwasher loaded correctly? Refer to the "Dishwasher Loading" section.

Is the water temperature too low? If needed, turn home water heater up to ensure water entering dishwasher is at least 120°F (49°C). Refer to the "Dishwasher Efficiency Tips" section.

Did you use the correct amount of fresh detergent? Use recommended dishwasher detergents only. Refer to the "Detergent Dispenser" section. Never use less than 1 tb (15 g) per load. Detergent must be fresh to be effective. Store detergent in a cool, dry area. Heavy soil and/or hard water generally require extra detergent.

Is detergent caked in dispenser? Use fresh detergent only. Do not allow detergent to sit for several hours in a wet dispenser. Clean dispenser when caked detergent is present.

Is the pump or spray arm clogged by labels from bottles and cans? Remove labels before washing bottles and cans or wash by hand.

Is the home water pressure high enough for proper dishwasher filling? Home water pressure should be 20 to 120 psi (138 to 828 kPa) for proper dishwasher fill. A booster pump on the water supply can be added if pressure is too low.

Are high suds slowing the wash arm? Never use soap or laundry detergents. Use recommended dishwasher detergents only.

Spots and stains on dishes

■ Spotting and filming on dishes

Is your water hard or is there a high mineral content in your water? Conditioning the final rinse water with a liquid rinse aid helps eliminate spotting and filming. Keep the rinse aid dispenser filled.

Is the water temperature too low? If needed, turn home water heater up to ensure water entering dishwasher is at least 120°F (49°C). Refer to the "Dishwasher Efficiency Tips" section.

Did you use the correct amount of effective detergent? Use recommended dishwasher detergents only. Refer to the "Detergent Dispenser" section. Never use less than 1 tb (15 g) per load. Detergent must be fresh to be effective. Store detergent in a cool, dry area. Heavy soil and/or hard water generally require extra detergent.

Is the home water pressure high enough for proper dishwasher filling? Home water pressure should be 20 to 120 psi (138 to 828 kPa) for proper dishwasher fill. A booster pump on the water supply can be added if pressure is too low.

NOTE: To remove spots and film from dishes, try a white vinegar rinse. This procedure is intended for occasional use only. Vinegar is an acid and using it too often could damage your dishwasher.

1. Wash and rinse dishes. Use an air-dry or an energy saving dry option. Remove all silverware or metal items.
2. Put 2 cups (473 mL) white vinegar in a glass or dishwasher-safe measuring cup on the bottom rack.
3. Run the dishwasher through a complete washing cycle using an air-dry or an energy saving dry option. Do not use detergent. Vinegar will mix with the wash water.

■ Silica film or etching (silica film is a milky, rainbow-colored deposit; etching is a cloudy film)

Sometimes there is a water/chemical reaction with certain types of glassware. This is usually caused by some combination of soft or softened water, alkaline washing solutions, insufficient rinsing, overloading the dishwasher, and the heat of drying. It might not be possible to prevent the problem, except by hand washing.

To slow this process use a minimum amount of detergent but not less than 1 tb (15 g) per load. Use a liquid rinse aid and underload the dishwasher to allow thorough rinsing. Silica film and etching are permanent and cannot be removed. Do not use heated drying.

■ White spots on cookware with non-stick finish

Has the dishwasher detergent removed cookware seasoning? Reseason cookware after washing in the dishwasher.

■ Brown stains on dishes and dishwasher interior

Does your water have high iron content? Rewash dishes using 1-3 tsp (5-15 mL) of citric acid crystals added to the covered section of the detergent dispenser. Do not use detergent. Follow with a Normal wash cycle with detergent. If treatment is needed more often than every other month, the installation of an iron removal unit is recommended.

■ Black or gray marks on dishes

Are aluminum items rubbing dishes during washing? Disposable aluminum items can break down in the dishwasher and cause marking. Hand wash these items. Remove aluminum markings by using a mild abrasive cleaner.

■ Orange stains on plastic dishes or dishwasher interior

Are large amounts of tomato-based foods on dishes placed in the dishwasher? Stains gradually fade over time. Regular use of heated drying will slow fading. Stains will not affect dishwasher performance. Regular use of a rinse cycle and an air-dry or energy-saving dry option will reduce the likelihood of staining.

Dishes do not dry completely

■ Dishes are not dry

Did you load your dishwasher to allow proper water drainage? Do not overload. Refer to the "Dishwasher Loading" section. Use a liquid rinse aid to speed drying.

Are the plastics wet? Plastics often need towel drying.

Is the rinse aid dispenser empty? Refer to the "Rinse Aid Dispenser" section.

Did you use an air-dry or energy-saving dry option? Use a heated drying option for dryer dishes.

Dishes are damaged during a cycle

■ Chipping of dishes

Did you load the dishwasher properly? Load the dishes and glasses so they are stable and do not strike together from washing action. Minimize chipping by moving the rack in and out slowly.

NOTE: Antiques, feather-edged crystal, and similar types of china and glassware might be too delicate for automatic dishwashing. Wash by hand.

Noises

■ Grinding, grating, crunching or buzzing sounds

A hard object has entered the wash module (on some models). The sound should stop when the object is ground up.

Notes

ENGLISH

Get it fixed, at your home or ours!

For repair of major brand appliances **in your own home...**
no matter who made it, no matter who sold it!

1-800-4-MY-HOMESM Anytime, day or night
(1-800-469-4663)

www.sears.com

To bring in products such as vacuums, lawn equipment and electronics
for repair, call for the location of your nearest **Sears Parts & Repair Center**

1-800-488-1222 Anytime, day or night

www.sears.com

For the replacement parts, accessories and owner's manuals
that you need to do-it-yourself, call **Sears PartsDirectSM**!

1-800-366-PART 6 a.m. – 11 p.m. CST,
(1-800-366-7278) 7 days a week

www.sears.com/partsdirect

To purchase or inquire about a Sears Service Agreement:

1-800-827-6655

7 a.m. – 5 p.m. CST, Mon. – Sat.

Para pedir servicio de reparación a domicilio,
y para ordenar piezas con entrega a domicilio:

1-888-SU-HOGARSM
(1-888-784-6427)

Au Canada pour service en français:

1-877-LE-FOYERSM
(1-877-533-6937)

SEARS
HomeCentral

3384416
© 2000 Kenmore

® Registered Trademark/TM Trademark of Sears, Roebuck and Co., under licensee by Sears Canada

® Marca Registrada/TM marca de fábrica de Sears, Roebuck and Co., con licencia de Sears Canada

® Marque déposée/TM Marque de commerce de Sears, Roebuck and Co., en vertu d'une licence de Sears Canada

As an ENERGY STAR® partner, Sears, Roebuck and Co. has determined that this product meets the ENERGY STAR® guidelines for energy efficiency.

En su calidad de socio ENERGY STAR®, Sears, Roebuck and Co. ha determinado que este producto cumple con las directrices ENERGY STAR® de rendimiento energético.

À titre de partenaire ENERGY STAR®, Sears, Roebuck and Co. a déterminé que produit satisfait aux directives d'efficacité énergétique ENERGY STAR®.

5/00
Printed in U.S.A.
Impreso en Los EE. UU.
Imprimé E.-U.

Free Manuals Download Website

<http://myh66.com>

<http://usermanuals.us>

<http://www.somanuals.com>

<http://www.4manuals.cc>

<http://www.manual-lib.com>

<http://www.404manual.com>

<http://www.luxmanual.com>

<http://aubethermostatmanual.com>

Golf course search by state

<http://golfingnear.com>

Email search by domain

<http://emailbydomain.com>

Auto manuals search

<http://auto.somanuals.com>

TV manuals search

<http://tv.somanuals.com>