

# Kenmore

## FREEZER OWNER'S MANUAL

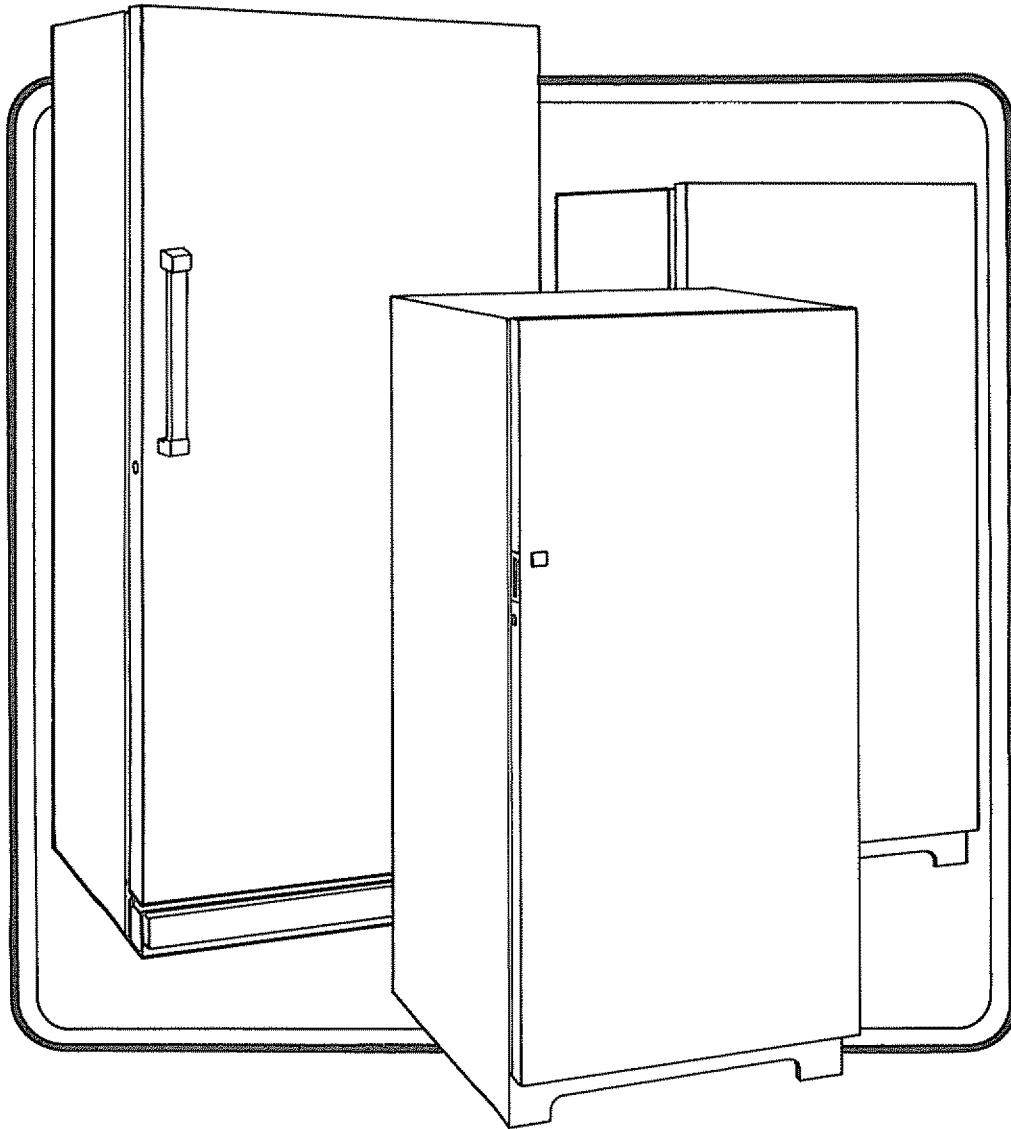

### Safety First

Unused or abandoned freezers are still dangerous . . . even if they "just sit in the garage a few days." If you are getting rid of your old freezer, do it safely. Please read the included safety instructions from the Association of Home Appliance Manufacturers.

**HELP PREVENT ACCIDENTS**

CONTENTS			
Safety First .....	Front Cover	Before Calling for Service .....	6
Install it .....	2	Defrost it .....	7
Level it .....	2	Quick Defrost .....	7
Ground it .....	2	Clean it .....	7
Adjust it .....	3	Energy Savings Tips .....	7
Start it .....	3	Vacation and Moving Care .....	7
Features .....	3-4-5-6	Warranty .....	Back Cover

### Install It

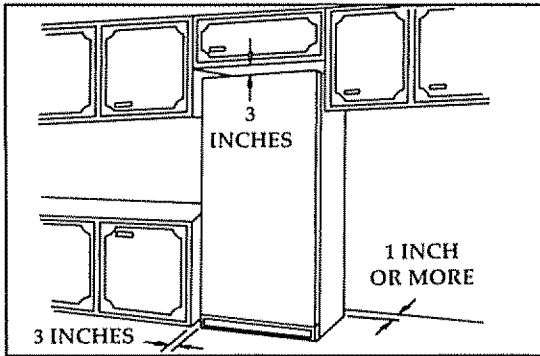

Allow three inches of air space on all sides of the freezer

- Keep away from flammables, such as gasoline.
- The floor must support the weight of the freezer when fully loaded.
- Keep away from an oven or other heat source. Preferably locate in an area below 100°F

### Level It

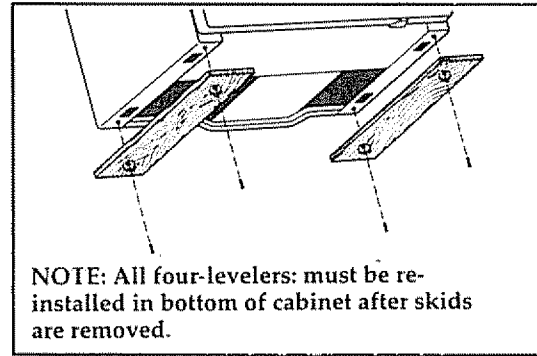

To Level:

- Screw levelers up as far as possible
- Adjust levelers down until the cabinet is level.
- Try to move or rock cabinet to check for stability
- If cabinet is "wobbling" adjust levelers as required to stabilize for a firm installation.
- As a tip, the door will close more readily if front of cabinet is slightly higher than rear.

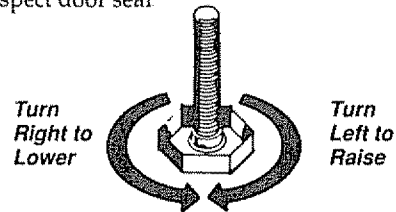

### Ground It

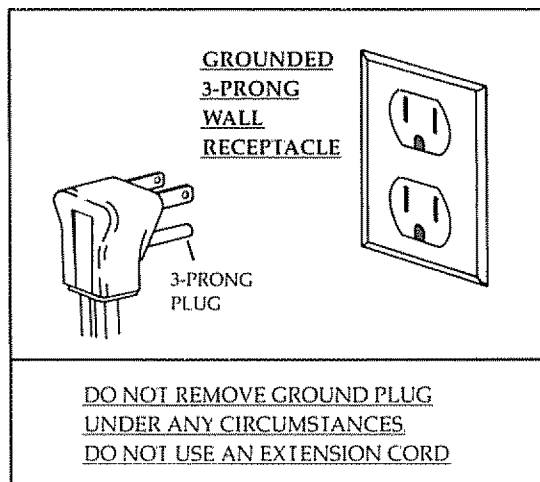

For your safety and protection, the Kenmore freezer is equipped with a special three-terminal type grounding plug on the electrical cord. It must be plugged into its own properly grounded three-prong outlet—115 volt, 60 Hertz, protected with a 15 amp time delay fuse or circuit breaker.

Do not plug the freezer into an outlet controlled by a wall switch or pull cord which might be turned off accidentally.

If the electrical outlet you intend to use will not accept the three-prong plug, or if you are not sure the outlet is adequately grounded, you should have a properly grounded three-prong outlet installed according to the National Electrical Code by a qualified electrician.

Never unplug your freezer by pulling on the cord. Always grip the plug firmly and pull straight out from the receptacle.

## Adjust It

Ice cream is a good indicator for adjusting freezer temperatures. Ice cream should be firm. If it is too soft, turn the cold control to a higher number. If ice cream is too hard and brick like turn the cold control to a lower number. After a few days you may want to "fine tune" the cold control for the best temperature

## Features

See pages 4 & 5 for features on your model

### Start It

#### **COLD CONTROL LOCATION**

Cold control is located inside the freezer on the right side

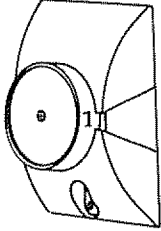

Cold control is set at #1. Allow freezer to run about 4 hours to cool thoroughly before adding food.

**NOTE:** Do not freeze more than 3 pounds of unfrozen food per cubic feet of space. Add more after first load is frozen

### Power Signal Light

#### **WARNS OF ANY UNKNOWN POWER FAILURE**

If light is out, quickly check:

- Power failure.
- Disconnected power cord.
- Signal light burned out

**NOTE: POWER SIGNAL LIGHT SHOWS POWER TO FREEZER ONLY.**

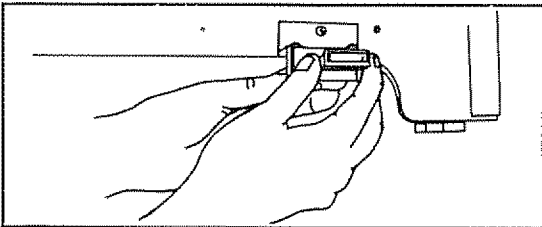

#### **IF IT BURNS OUT**

- Unplug power cord at wall.
- Remove base trim by pulling straight out.
- Reach behind light and push entire light and rubber plug forward
- Grasp light unit firmly and pull from rubber plug
- Replace new light unit securely into rubber plug and snap into position. Replacement signal light can be purchased at your nearest Sears Service Center. Plug in freezer.

### Textured Steel Door

Helps hide smudges and fingerprints.

### Door Closer

Located in your bottom hinge.  
Never needs cleaning or adjusting.

### Interior Light

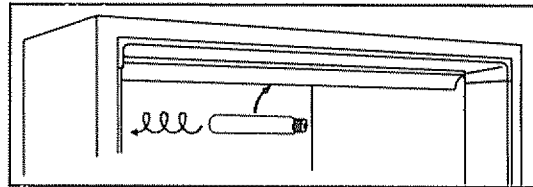

- In case of light failure
- Turn cold control off
- Unplug power cord at wall.
- Replace bulb with 25W appliance bulb, which can be purchased through a Sears Service Center
- Plug in freezer and turn on

### Security Lock

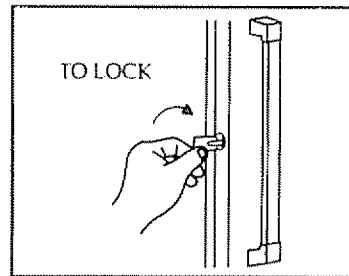

Key pops out for security – store in safe place. To lock or unlock the freezer you must push the key in the lock while turning. The lock is spring loaded so the key cannot be left in the lock.

### Removable Freezer Basket and Trivet

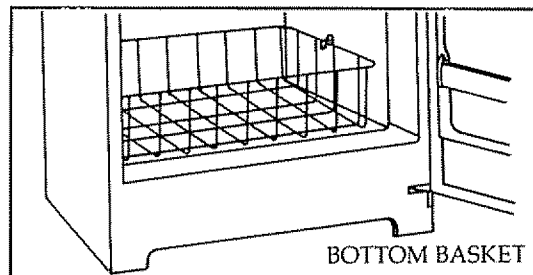

BOTTOM BASKET

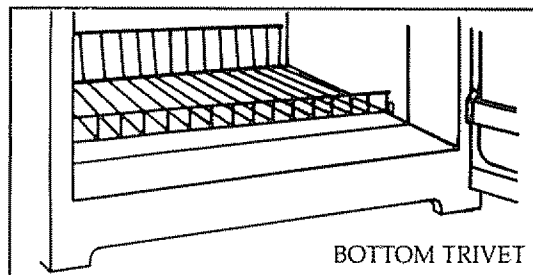

BOTTOM TRIVET

INSTALL IT

LEVEL IT

GROUND IT

START IT

ADJUST IT

FEATURES

PREMIUM  
MODEL 20938 (19.3 CU. FT.)

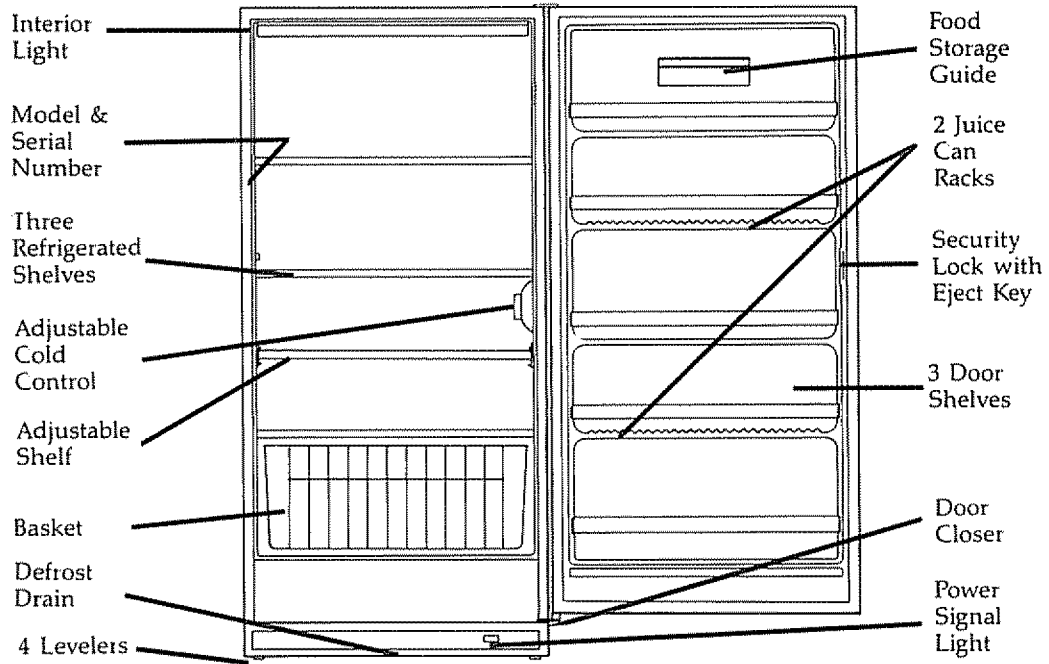

Almond Exterior  
Deluxe Pull Door Handle  
Magnetic Door Gasket

Cabinet Thinwall Foam Insulation  
Textured Steel Door and Cabinet

PREMIUM  
MODEL 20638 (16.0 CU. FT.)

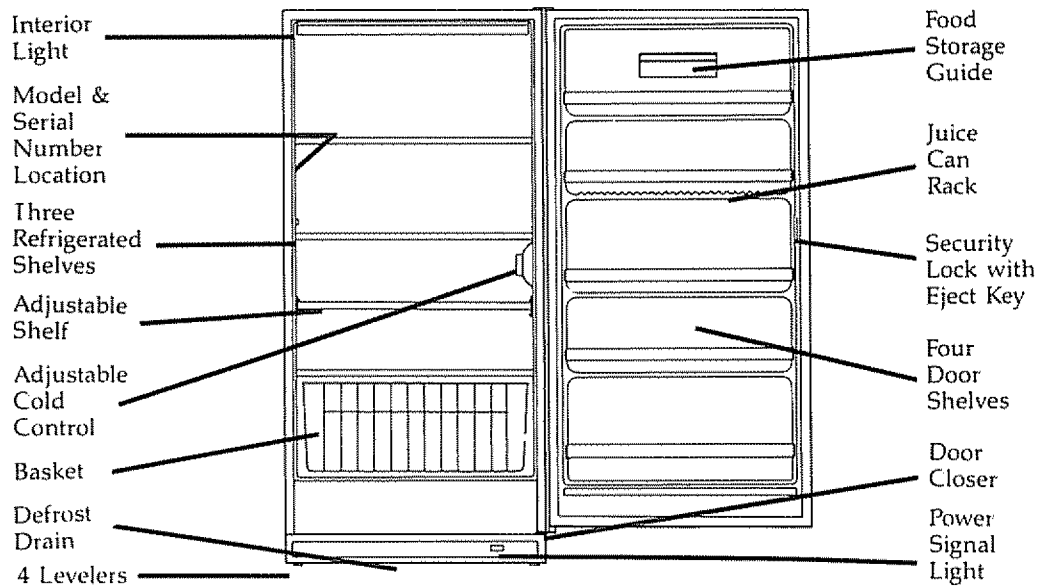

Almond Exterior  
Deluxe Pull Door Handle  
Magnetic Door Gasket

Cabinet Thinwall Foam Insulation  
Textured Steel Door and Cabinet

BETTER

MODEL 20628 (16.0 CU FT)

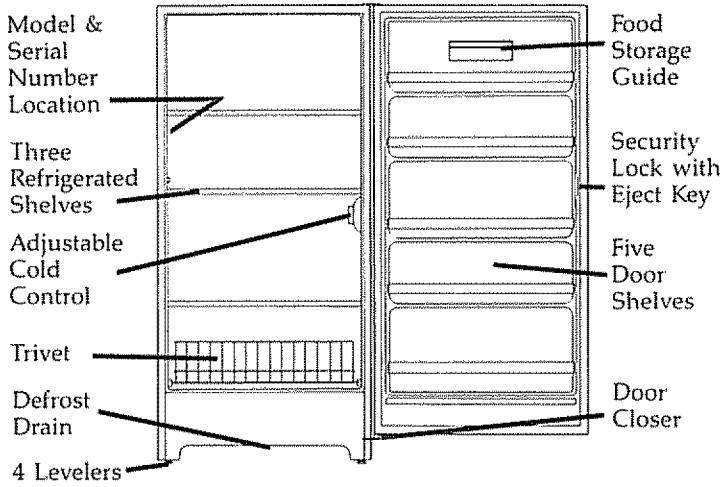

Almond Exterior  
Deluxe Handle  
Magnetic Door Gasket

Cabinet Thinwall Foam Insulation  
Textured Steel Door and Cabinet

BETTER

MODEL 20328 (13.3 CU FT)

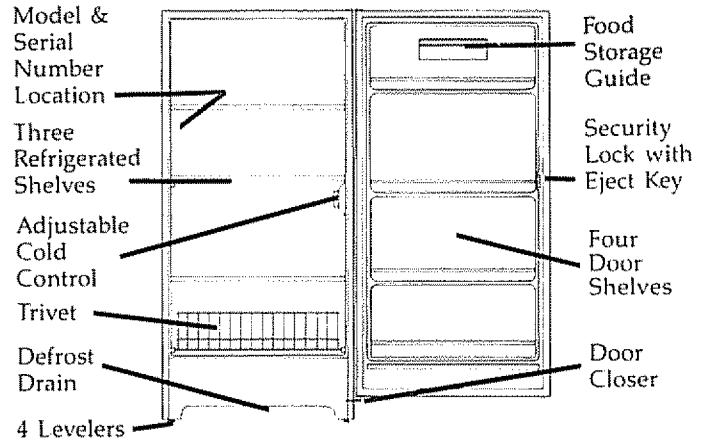

Almond Exterior  
Deluxe Handle  
Magnetic Door Gasket

Cabinet Thinwall Foam Insulation  
Textured Steel Door and Cabinet

PREMIUM

GOOD

MODEL 20018 (10.1 CU. FT)

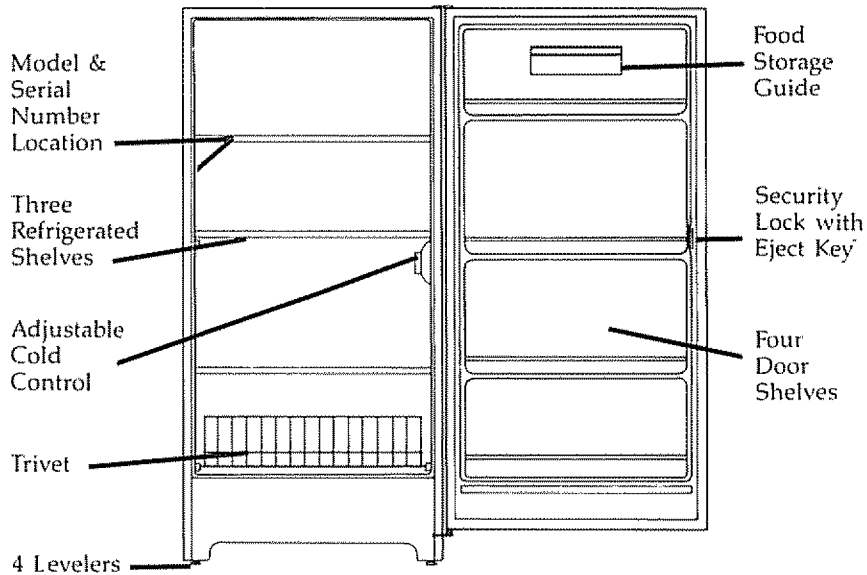

Almond Exterior  
Deluxe Cup Handle  
Magnetic Door Gasket

Cabinet Thinwall Foam Insulation  
Textured Steel Door and Cabinet

BETTER

GOOD

## FEATURES CONTINUED - CHECK YOUR FREEZER

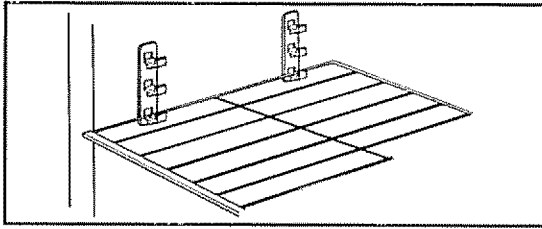

Three position adjustable shelf can be moved to any one of three positions for larger or smaller packages.

### BEFORE CALLING FOR SERVICE

#### Runs too long or appears warm

- See if Cold Control is set colder than necessary. Remember: the higher the number, the colder the temperature.
- Be sure food packages are not keeping door from closing tightly.
- Unfrozen food may cause the freezer to run longer than normal.
- Room temperature may be too warm. If freezer temperature keeps going up, call Sears Service right away.

#### Frost Forms Unevenly

- Too many door openings in high humidity conditions
- Limit length of door openings when possible.
- Keep packages from blocking door.
- Door not sealing properly (See page 2, level it)
- Due to natural air flow patterns, a vertical upright freezer will often form more frost on the upper shelf

#### Too Noisy

- The refrigerant will gurgle
  - The compressor will click on and off
  - You may even hear it hum or vibrate
- These are all normal sounds of your freezer at work.

#### Exterior Wall Feels Warm

- This is a normal operating condition.

#### Moisture Collects On Outside

- Freezer may be in path of hot humid air. Freezer temperature may be too cold
- Reset Cold Control to smaller number
- Some moisture is normal in hot, humid weather

#### Power Fails

- Short time failure (less than 24 hours): Frozen food will keep safely for about 24 hours if freezer door is kept shut and room air does not exceed 80°F
- Long time failure (more than 24 hours): Take food to frozen food locker or place dry ice inside freezer. (See Yellow Pages under "Dry Ice")

#### DRY ICE REQUIREMENTS PER 24 HOURS

FREEZER SIZE	ROOM TEMPERATURE
	70° to 100°
5 to 10 cu ft	20 to 25 lbs.
10 to 15 cu ft	25 to 40 lbs
15 to 20 cu ft	40 to 50 lbs
20 to 30 cu ft	50 to 60 lbs
30 cu ft or over	60 to 70 lbs

**WARNING: DRY ICE WILL BURN YOUR SKIN: WEAR HEAVY GLOVES.**

#### Doesn't Run

- Check outlet for power
- Be sure Cold Control is "ON"

#### Door Difficult To Open

In order to ensure that your frozen food is maintained at a safe and constant low temperature, your freezer has a magnetic strip in the gasket to maintain an airtight seal.

This seal is so effective that the simple action of closing the door will almost instantly create a vacuum as the warm air quickly cools.

This vacuum will leave in a minute or two. If you must reopen the door sooner, try peeling the gasket open with fingertips as door is pulled open.

## Defrost It

You should defrost your freezer when the frost becomes 1/4" thick. Further accumulation will reduce operating efficiency. How often you have to defrost depends on the type and amount of food you freeze, the temperature and humidity and the number of times you open and close the freezer (The period between defrosting can be extended by scraping frost every so often with a plastic scraper.)

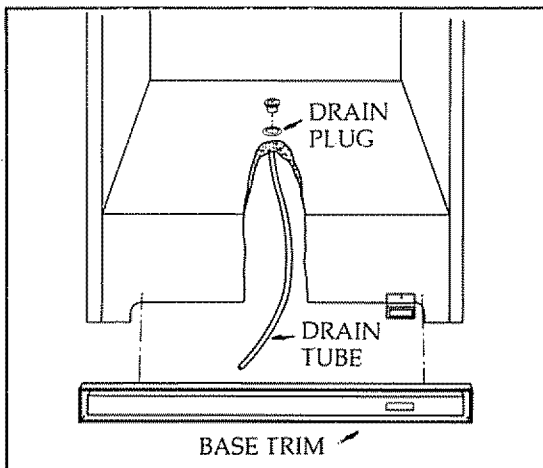

### **Here is how**

- Turn cold control off
- Unplug power cord at wall.
- Remove all frozen food and wrap in several thicknesses of newspaper and place in boxes
- Remove drain plug
- Remove base trim (on some models) by pulling straight out
- The drain tube is located near the left center under the freezer. The defrost water can be collected in any suitable shallow pan
- Leave door open and wait for frost to melt.
- On models without a defrost drain, place towels or newspapers on the freezer bottom to catch the frost. The frost will loosen and fall. Remove paper and/or towels.

## Quick Defrost

*(Tips to speed defrosting)*

- Place towel in bottom of freezer (over defrost drain) to absorb excess moisture
- Place pans of hot water on refrigerated shelves
- Wipe with a cloth or sponge (do not use sharp objects or electric defrost devices)
- After defrost - plug in freezer
- Turn cold control back to original position

## Clean It

- Unplug power cord at wall
- While defrosting the freezer, take time to clean the inside thoroughly
- Use a mild solution of baking soda (2 tablespoons) in warm water (1 quart)
- Clean all inside surfaces
- To protect exterior-use a good quality automotive wax

## Energy Saving Tips

- Close door as soon as you can.
- Reduce door openings.
- Check door to make sure it has shut tightly.
- Adjust cold control. (See Pages 2, 3 Start It, Adjust It.)
- Do not put hot foods in freezer. Let hot food cool to room temperature before placing in freezer
- Keep freezer away from stove, or other heat sources. A cool dry place is recommended.

## Vacation?

- For a short vacation arrange for someone to inspect it at regular intervals
- For longer periods of time you may wish to remove food, unplug your freezer, defrost, clean thoroughly and block door open to prevent odor and/or mildew growth.

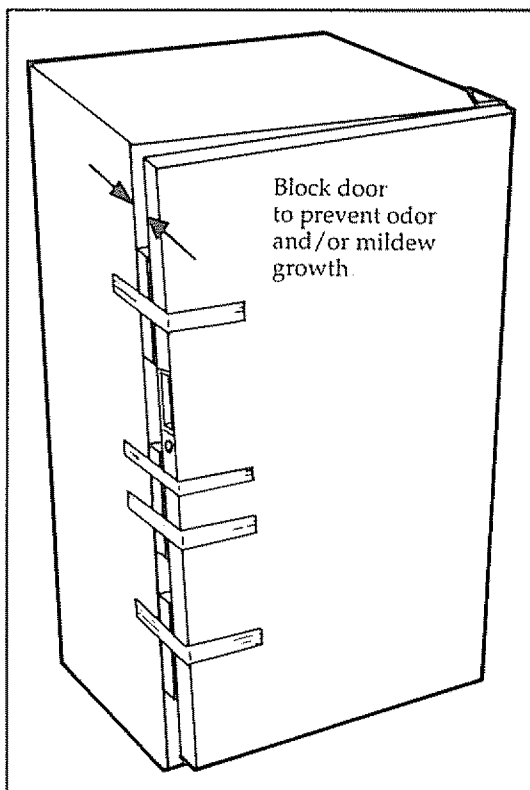

## Moving?

- Remove all food and then defrost
- Clean thoroughly and allow to dry (otherwise odors will build up)
- Tape all interior loose baskets securely in position
- Tape door securely shut.
- Ship in upright position - never on back.



### FULL ONE YEAR WARRANTY ON FREEZER

For one year from the date of purchase, when this freezer is operated and maintained according to instructions attached to or furnished with the product, Sears will repair this freezer free of charge if defective in material or workmanship.

### FULL FIVE YEAR WARRANTY ON SEALED REFRIGERATION SYSTEM

For five years from the date of purchase, when this freezer is operated and maintained according to instructions attached to or furnished with the product, Sears will repair the sealed system (consisting of refrigerant, connecting tubing and compressor motor) free of charge if defective in material or workmanship. The above warranty coverage applies only to freezers which are used for storage of food for private household purposes.

WARRANTY SERVICE IS AVAILABLE BY CONTACTING THE NEAREST SEARS SERVICE CENTER/DEPARTMENT IN THE UNITED STATES. This warranty applies only while this product is in use in the United States.

### Food Loss Coverage Limitation

If promptly reported to your nearest Sears store or Service Center, Sears will reimburse you up to a total of \$100.00 for the value of food, as verified by Sears, lost while stored in the freezer when used for private household purposes as a result of:

1. Defects that occur during the first year following date of purchase.
2. Failure of the sealed system (including refrigerant, connecting tubing and compressor motor) due to defects that occur during the second through fifth year after purchase. If freezer is used for other than private household purposes Sears will not be responsible for any food loss. Food losses resulting from other than the above stated defects, such as: natural spoilage, power interruption, inadequate power, manual disconnect of power supply, fire damage, water damage, theft, etc., are beyond our control and are not covered by Sears. Some states do not allow the exclusion or limitation of incidental or consequential damages, so the above limitation or exclusion may not apply to you. This warranty gives you specific legal rights and you may also have other rights which vary from state to state.

SEARS, ROEBUCK AND CO Dept 731 CR-W, Sears Tower, Chicago, IL 60684

## WE SERVICE WHAT WE SELL

"We Service What We Sell" is our assurance to you that you can depend on Sears for service, and Sears service is nationwide.

Your Kenmore has added value when you consider that Sears has a service unit near you, staffed by Sears trained technicians . . . professional technicians specifically trained on Sears appliances, having the parts, tools and equipment to ensure that we meet our pledge to you . . . "We Service What We Sell"

SHOULD YOU EVER NEED SERVICE, REMEMBER . . . TO GIVE THE COMPLETE TEN-DIGIT MODEL NUMBER AND COMPLETE SERIAL NUMBER OF YOUR KENMORE FREEZER

TO FURTHER ADD TO THE VALUE OF YOUR KENMORE FREEZER, BUY A SEARS MAINTENANCE AGREEMENT

Sears Kenmore appliances are designed, manufactured and tested for years of dependable operation. Yet, any modern appliance may require service from time to time. The Sears warranty plus the Sears maintenance agreement provide protection from unexpected repair bills.

CONTACT YOUR SEARS SALES PERSON OR LOCAL SEARS SERVICE CENTER TODAY AND PURCHASE A SEARS MAINTENANCE AGREEMENT

Record in the space below the model number and serial number of this freezer. They are located inside upper left side of freezer.

Model Number 253. \_\_\_\_\_ Serial Number \_\_\_\_\_  
Date Purchased \_\_\_\_\_



## Free Manuals Download Website

<http://myh66.com>

<http://usermanuals.us>

<http://www.somanuals.com>

<http://www.4manuals.cc>

<http://www.manual-lib.com>

<http://www.404manual.com>

<http://www.luxmanual.com>

<http://aubethermostatmanual.com>

Golf course search by state

<http://golfingnear.com>

Email search by domain

<http://emailbydomain.com>

Auto manuals search

<http://auto.somanuals.com>

TV manuals search

<http://tv.somanuals.com>