



# MICROWAVE OVEN

Use and Care Guide

# HORNO DE MICROONDAS

Manual de Uso y Cuidado

Models/Modelos 721.62342



ENGLISH

ESPAÑOL

Sears, Roebuck and Co., Hoffman Estates, IL 60179 U.S.A.

P/NO.: 3828W5A2594

[www.sears.com](http://www.sears.com)

# TABLE OF CONTENTS

<b>WARRANTY</b> .....	<b>2</b>	Kitchen Timer .....	9
<b>SAFETY</b> .....	<b>3-4</b>	Child Lock .....	9
Precautions To Avoid Possible Exposure		Sensor Cook Operation Instruction .....	10
To Excessive Microwave Energy .....	3	Potato .....	10
Grounding Instructions.....	3	Sensor Cook Table.....	11
Important Safety Instructions.....	4	Add Minute.....	11
<b>UNDERSTANDING YOUR</b>		Auto Defrost.....	12
<b>MICROWAVE OVEN</b> .....	<b>5-8</b>	Auto Defrost Table .....	13
Specifications.....	5	Timed Cooking.....	13
Installation.....	5	Multi-Stage Cooking .....	14
Parts And Accessories .....	6	Microwave Power Levels .....	14
Control Panel.....	6	Cooking Tips.....	15-16
Cookware Guide.....	7	<b>TROUBLESHOOTING</b> .....	<b>17-19</b>
Tips For Microwave Cooking .....	8	Questions And Answers .....	17-18
Cleaning.....	8	Before Calling For Service.....	19
<b>USING YOUR MICROWAVE OVEN</b> .....	<b>9-18</b>		
Clock.....	9		

ENGLISH

## WARRANTY

### FULL ONE-YEAR WARRANTY ON MICROWAVE OVEN

For one year from the date of purchase, if this Kenmore microwave oven fails due to a defect in material or workmanship, Sears will repair it free of charge.

### FULL FIVE-YEAR WARRANTY ON THE MAGNETRON

For five years from the date of purchase, if the magnetron in this Kenmore microwave oven fails due to a defect in material or workmanship, Sears will repair it free of charge.

### WARRANTY SERVICE

For warranty service, return the microwave to your nearest Sears Parts & Repair Center in the United States. For the location of your nearest Sears Parts & Repair Center, call 1-800-4-MY-HOME®.

This warranty applies only while this product is in use in the United States.

This warranty gives you specific legal rights, and you may also have other rights which vary from state to state.

**Sears, Roebuck and Co., D/817WA,  
Hoffman Estates, IL. 60179 U.S.A.**

# SAFETY

## PRECAUTIONS TO AVOID POSSIBLE EXPOSURE TO EXCESSIVE MICROWAVE ENERGY ...

- **Do not attempt to operate this oven with the door open**, since open-door operation can result in harmful exposure to microwave energy. It is important not to defeat or tamper with the safety interlock.
- **Do not operate the oven if it is damaged.** It is particularly important that the oven door close properly and that there is no damage to the:
  - door (bent)
  - hinges and latches (broken or loosened)
  - door seals and sealing surfaces.
- **Do not place any object between the oven front face and the door**, or allow soil or cleaner residue to accumulate on sealing surfaces.
- **The oven should not be adjusted or repaired** by anyone except properly qualified service personnel.

## GROUNDING INSTRUCTIONS

This appliance must be grounded! If an electrical short circuit occurs, grounding reduces the risk of electric shock by providing an escape wire for the electric current. This appliance is equipped with a cord having a grounding wire with a grounding plug.

Put the plug into an outlet that is properly installed and grounded.

### **WARNING**

**If you use the grounding plug improperly, you risk electric shock.**

Ask a qualified electrician or the Sears Service Department if you do not understand the grounding instructions or if you wonder whether the appliance is properly grounded.

This appliance has a short power supply cord to reduce the risk of anyone's tripping over or becoming entangled in the cord. You may use an extension cord if you are careful.

**If you use an extension cord, be sure that:**

- The extension cord has the same electrical rating as the appliance.
- The marked rating of the extension cord shall be equal to or greater than the electrical rating of the appliance.
- The extension cord is a grounding-type 3-wire cord.
- The extension cord does not drape over a countertop or tabletop, where it can be pulled on by children or tripped over accidentally.
- The electrical cord is dry and not pinched or crushed in any way.

**NOTE: This oven draws 14 amperes at 120 Volts, 60 Hz.**

# SAFETY

## IMPORTANT SAFETY INSTRUCTIONS

The safety instructions below will tell you how to use your oven to avoid harm to yourself or damage to your oven.

**WARNING** — To reduce the risk of burns, electric shock, fire, injury to persons, or exposure to excessive microwave energy:

1. **Read all the instructions before using your oven.**
2. **Do not allow children to use this oven without close supervision!**
3. Read and follow the specific **PRECAUTIONS TO AVOID POSSIBLE EXPOSURE TO EXCESSIVE MICROWAVE ENERGY** found on page 3.
4. **Do not tamper with the built – in safety switches on the oven door!** The oven has several built-in safety switches to make sure the power is off when the door is open.
5. **When cleaning the door and the surfaces that touch the door, use only mild, nonabrasive soaps or detergents and a sponge or soft cloth.**
6. **If your oven is dropped or damaged,** have it thoroughly checked by a qualified service technician before using it again.
7. **To avoid a fire hazard:**
  - a) **Do not severely overcook foods.** It can cause a fire in the oven.
  - b) **Do not use recycled paper products in your oven.** They can contain particles that can cause arcing or may ignite.
  - c) **Do not overcook potatoes.** Overcooking could cause a fire.
  - d) **Do not store combustible items** (bread, cookies, etc.) **in the oven,** because if lightning strikes the power lines, it may cause the oven to turn ON.
  - e) **Do not use wire twist-ties in the oven.** Be sure to remove them before placing the item in the oven.
  - f) **Do not use the cavity for storage purposes.** Do not leave paper products, cooking utensils, or food in the cavity when not in use.
8. **If a fire should start:**
  - a) **Keep the oven door closed.**
  - b) **Turn the oven off.**
  - c) **Disconnect the power cord or shut off the power at the fuse or circuit breaker panel.**
9. Do not use this oven for commercial purposes. This microwave is made for household use only.
10. Install or locate this appliance in accordance with the provided installation instructions.
11. **To avoid electric shock:**
  - a) **This appliance must be grounded!** Connect it only to a properly grounded outlet. (See the **Grounding instructions** on page 3.)
  - b) **Do not operate this appliance if it has a damaged cord or plug,** if it is not working properly, or if it has been damaged or dropped.
  - c) **Do not immerse the electrical cord or plug in water.**
  - d) **Keep the cord away from heated surfaces.**
  - e) This appliance should be serviced only by qualified service personnel.
12. Liquids such as water, coffee, or tea are able to be overheated beyond the boiling point without appearing to be boiling due to surface tension of the liquid. Visible bubbling or boiling when the container is removed from the microwave oven is not always present. This could result in very hot liquids suddenly boiling over when a spoon or other utensil is inserted into the liquid. To reduce the risk of injury to persons; 1) Do not overheat the liquid. 2) Stir the liquid both before and halfway through heating it. 3) Do not use straight-sided containers with narrow necks. 4) After heating, allow the container to stand in the microwave oven for a short time before removing the container. 5) Use extreme care when inserting a spoon or other utensil into the container.
13. Keep the glass tray and the turntable roller rest in the oven when you are cooking.
14. Do not use the oven outdoors. Do not store the oven outdoors. Do not use this product near water.
15. Do not cover or block any openings in the oven.
16. Do not run the microwave oven empty.
17. Do not let the cord hang over the edge of a table or counter.
18. Do not heat glass turntable excessively.
  - Do not cook bacon directly on the glass turntable.
  - Do not allow the grey film on special microwave cooking packages to touch the glass turntable. Put the package on a microwave-safe dish.
  - Keep a browning dish at least  $\frac{3}{16}$  inch above the glass turntable. If you use the browning dish incorrectly, you could break the glass turntable.
19. Be careful not to chip or scratch the edges of the turntable. Chips or scratches may cause the turntable to break during use.

**SAVE THESE INSTRUCTIONS!**

# UNDERSTANDING YOUR MICROWAVE OVEN

## SPECIFICATIONS

Power Supply	120 V AC, 60 Hz
Rated Power Consumption	1,600 W
Microwave Output	*1,200 W
Rated Current	13.5 A
Overall Dimensions (WxHxD)	22 <sup>19</sup> / <sub>32</sub> " X 13 <sup>17</sup> / <sub>32</sub> " X 17 <sup>5</sup> / <sub>16</sub> "
Oven Cavity Dimensions (WxHxD)	16 <sup>9</sup> / <sub>16</sub> " X 10 <sup>9</sup> / <sub>32</sub> " X 16 <sup>11</sup> / <sub>16</sub> "
Capacity of Oven Cavity	1.6 Cu. Ft.

\*IEC 60705 RATING STANDARD

Specifications subject to change without prior notice.

## INSTALLATION

1. Remove your Kenmore microwave oven and all packing materials from the shipping carton.
  2. Place the oven on a level surface that provides at least 4 inches of space at the left, right, top, and rear sides for proper ventilation.
  3. Place the turntable roller rest in the circle on the oven floor and then place the glass turntable on the top of the turntable roller rest.
- NOTE:** Never place the glass turntable in the oven upside down. Blocking the inlet and/or outlet openings can damage the oven.

ENGLISH

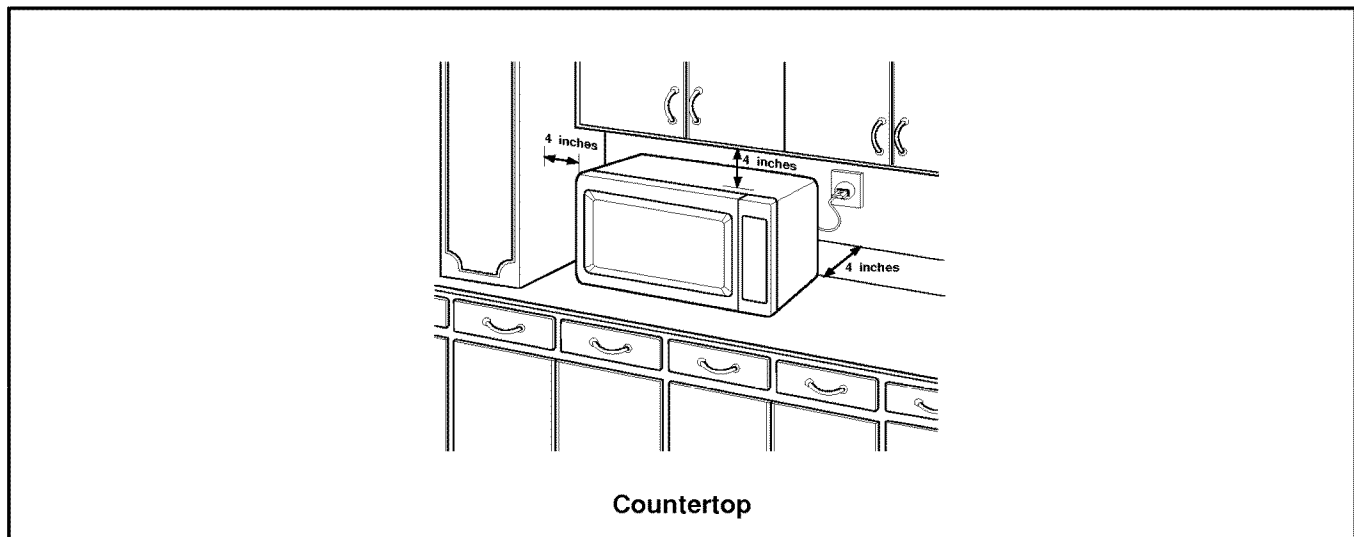

# UNDERSTANDING YOUR MICROWAVE OVEN

## PARTS AND ACCESSORIES

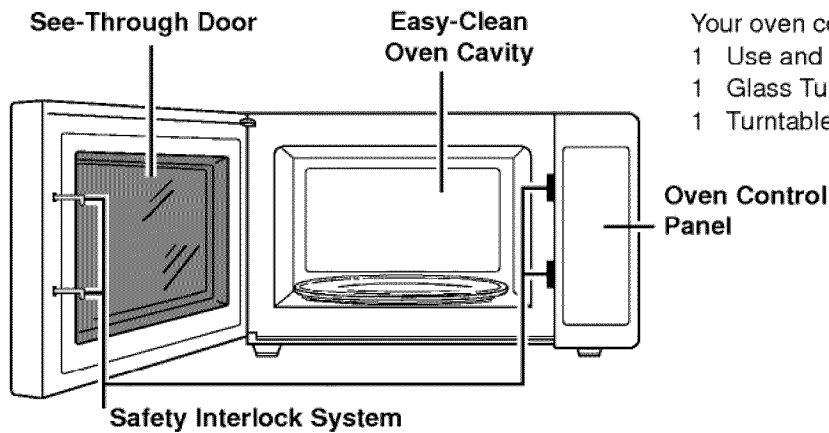

Your oven comes with the following accessories:

- 1 Use and Care Guide
- 1 Glass Turntable
- 1 Turntable Roller Rest

### Glass Turntable

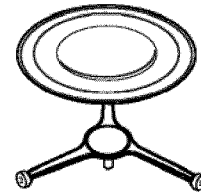

Turntable  
Roller Rest

ENGLISH

## CONTROL PANEL

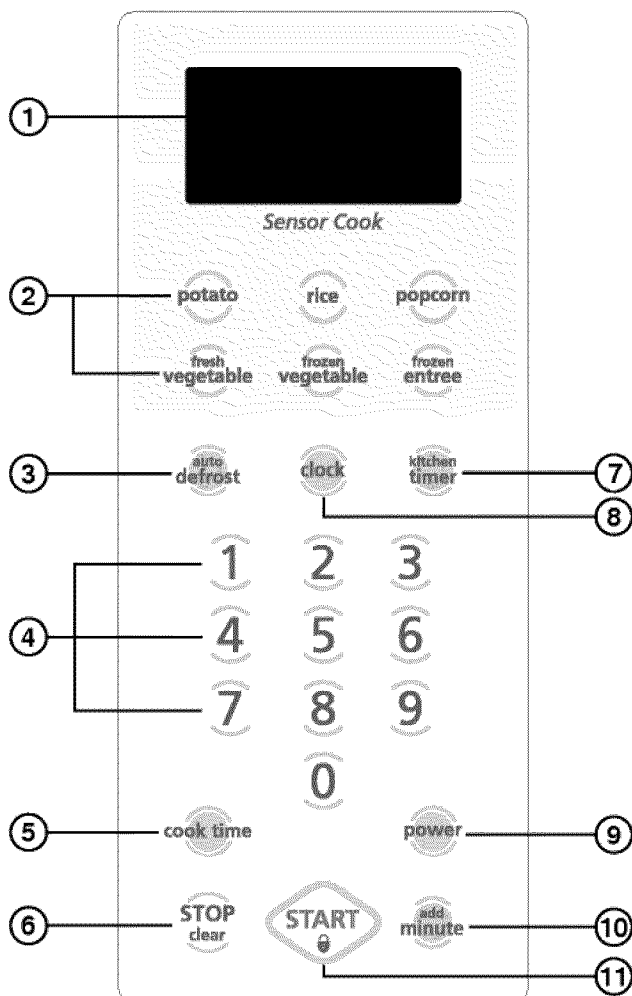

1. **DISPLAY.** The Display includes a clock and indicators that tell you time of day, cooking time settings, and cooking functions selected.
2. **SENSOR COOK.** This pad allows you to cook most of your favorite foods without having to select cooking times and power levels.
3. **AUTO DEFROST.** This pad is an accurate defrosting method for frozen meat, poultry and fish up to 6.0 lbs or 4.0 kgs.
4. **NUMBER PADS.** Touch Number Pads to enter cooking time, power level, quantities, or weights.
5. **COOK TIME.** Touch this pad to set a cooking time.
6. **STOP/CLEAR.** Touch this pad to stop the oven or clear entries.
7. **KITCHEN TIMER.** Touch this pad to use your microwave oven as a kitchen timer.
8. **CLOCK.** Touch this pad to enter the time of day.
9. **POWER.** Touch this pad to set a cooking power.
10. **ADD MINUTE.** Touch this pad to cook at 100% cook power for 1 minute to 99 minute 59 seconds.
11. **START.** Touch this pad to start all entries (except the Quick Touch Sensor, Express Defrost, Auto Cook and Add Minute function which start automatically) and to turn Child Lock on or off.

# UNDERSTANDING YOUR MICROWAVE OVEN

## COOKWARE GUIDE

Most heat-resistant, non-metallic cookware is safe for use in your microwave oven. However, to test cookware before using, follow these steps:

1. Place the empty cookware in the microwave oven.
2. Measure 1 cup of water in a glass measuring cup and place it in the oven beside the cookware.
3. Microwave on 100% power for 1 minute. If the dish is warm, it **should not** be used for microwave cooking.

USE	DO NOT USE
<p><b>Ovenproof Glass</b></p> <ul style="list-style-type: none"> <li>• Glass treated for use in high-intensity heat includes utility dishes, bread dishes, pie plates, cake plates, liquid measuring cups, casseroles, and bowls without metallic trim.</li> </ul> <p><b>China</b></p> <ul style="list-style-type: none"> <li>• Bowls, cups, serving plates, and platters without metallic trim can be used in your oven.</li> </ul> <p><b>Plastic</b></p> <ul style="list-style-type: none"> <li>• When using plastic wrap as a cover, make sure that the dish is deep enough so the plastic wrap does not touch the food. As the food heats, it may melt the plastic wrap wherever the wrap touches the food.</li> <li>• Place plastic wrap loosely over the top of the dish and secure it by pressing the wrap to the sides of the dish.</li> <li>• Vent by turning back one corner of the plastic wrap. This will allow excess steam to escape.</li> <li>• Use plastic dishes, cups, semi-rigid freezer containers, and plastic bags <b>only for short time cooking. Use these with care because the plastic may soften from the heat of the food.</b></li> </ul> <p><b>Paper</b></p> <ul style="list-style-type: none"> <li>• Microwave-safe paper towels, waxed paper, paper napkins, and paper plates with no metallic trim or design can be used in your oven.</li> <li>• Refer to the manufacturer's label for use of any paper product in the microwave oven.</li> </ul>	<p><b>Metal Utensil</b></p> <ul style="list-style-type: none"> <li>• Metal shields food from microwave energy and produces uneven cooking. Avoid metal skewers, thermometers, or foil trays.</li> <li>• Metal utensils can cause arcing, which is a discharge of electric current. Arcing can damage your microwave oven.</li> </ul> <p><b>Metal Decoration</b></p> <ul style="list-style-type: none"> <li>• Do not use metal-trimmed or metal-banded dinnerware, casserole dishes, etc.</li> </ul> <p><b>Centura™ Tableware</b></p> <ul style="list-style-type: none"> <li>• The Corning Company recommends that you <b>do not use</b> Centura tableware and some Corelle™ closed-handle cups for microwave cooking.</li> </ul> <p><b>Aluminum Foil</b></p> <ul style="list-style-type: none"> <li>• Avoid large sheets of aluminum foil because they hinder cooking and may cause arcing.</li> <li>• Use small pieces of foil to shield poultry legs and wings.</li> <li>• Keep <b>all</b> aluminum foil at least 1 inch from the walls and door of the oven.</li> </ul> <p><b>Wood</b></p> <ul style="list-style-type: none"> <li>• Wooden bowls, boards, and baskets will dry out and may split or crack when you use them in the microwave oven.</li> </ul> <p><b>Tightly Closed Containers</b></p> <ul style="list-style-type: none"> <li>• Tightly closed cookware can explode. Be sure to leave an opening for steam to escape from covered cookware.</li> </ul> <p><b>Brown Paper</b></p> <ul style="list-style-type: none"> <li>• Avoid using brown paper bags. They absorb heat and could burn.</li> </ul> <p><b>Metal Twist Ties</b></p> <ul style="list-style-type: none"> <li>• Always remove metal twist ties as they can become hot and cause a fire.</li> </ul>

ENGLISH

# UNDERSTANDING YOUR MICROWAVE OVEN

## TIPS FOR MICROWAVE COOKING

### BROWNING

Meat and poultry with high fat content that are cooked for 10 or 15 minutes or longer will brown lightly. Foods cooked a shorter time can be brushed with a browning agent, such as Worcestershire sauce, soy sauce, or barbecue sauce.

### COVERING

A cover traps heat and steam and causes the food to cook more quickly. Use a lid or microwave-safe plastic wrap with one corner folded back to vent the excess steam. Lids on glass casseroles can become hot during cooking. Handle carefully. Waxed paper will prevent the food from splattering in the oven and help retain heat. When warming bread items, use waxed paper, napkins, or paper towels. To absorb extra moisture, wrap sandwiches and fatty foods in paper towels.

### SPACING

Arrange individual foods, such as baked potatoes, cupcakes, and hors d'oeuvres in a circle and at least 1 inch apart. This will help the food cook more evenly.

### STIRRING

Stirring blends flavors and redistributes the heat in foods. Always stir from the outside toward the center of the dish. Food at the outside of the dish heats first.

### TURNING

Large foods, such as roasts and whole poultry, should be turned so that the top and bottom cook evenly. Also turn over chicken pieces and chops.

## CLEANING

Wipe the oven inside and outside with a soft cloth and a mild detergent solution. Then rinse and wipe dry. This should be done weekly or more often, if needed. Never use cleaning powders or rough pads. Excessive oil splatters on the inside top will be difficult to remove if left for many days. Wipe splatters with a wet paper towel, especially after cooking chicken or bacon.

### REMOVABLE PARTS

The turntable and turntable roller rest are removable. They should be hand-washed in warm (not hot) water with a mild detergent and a soft cloth. Once they are clean, rinse well and dry with a soft cloth. Never use cleaning powders, steel wool, or rough pads.

### ARRANGEMENT

Do not stack food. Arrange in a single layer in the dish for more even cooking. Because dense foods cook more slowly, place thicker portions of meat, poultry, fish, and vegetables toward the outside of the dish.

### TESTING FOR DONENESS

Because foods cook quickly in a microwave oven, you need to test frequently for doneness.

### STANDING TIME

Depending on density, food often needs to stand from 2 to 15 minutes after you remove it from the oven. Usually, you need to cover food during standing time to retain heat. Remove most foods when they are slightly undercooked and they will finish cooking during standing time. The internal temperature of food will rise about 10 °F during standing time.

### SHIELDING

To prevent some portions of rectangular or square dishes from overcooking, you may need to shield them with small strips of aluminum foil to block the microwaves. You can also cover poultry legs and wing tips with foil to keep them from overcooking. **Always keep foil at least 1 inch from oven walls** to prevent arcing.

### PIERCING

Pierce the shell, skin, or membrane of foods before cooking to prevent them from bursting. Foods that require piercing include yolks and whites of eggs, hot dogs, clams, oysters, and whole vegetables, such as potatoes and squash.

- The turntable may be cleaned at the sink. Be careful not to chip or scratch the edges as this may cause the turntable to break during use.
- The turntable roller rest should be cleaned regularly.

### SPECIAL CARE

For best performance and safety, the inner door panel and the oven front frame should be free of food or grease buildup. Wipe often with a mild detergent; then rinse and wipe dry. Never use cleaning powders or rough pads.

After cleaning the control panel, touch STOP/CLEAR to clear any entries that might have been entered accidentally while cleaning the panel.









# USING YOUR MICROWAVE OVEN

## CLOCK

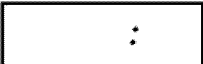
Example: To set the clock for 10:30(AM).

**Touch:**

**Display Shows:**

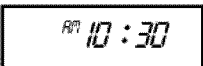
- |    |  |  |
|----|--|--|
| 1. |   |   |
| 2. |   | <i>: ENTER TIME OF DAY</i>   |
| 3. |   | <i>10 : 30 TOUCH START</i>   |
| 4. |   | <i>10 : 30 AM TOUCH 1<br/>PM TOUCH 2</i>   |
| 5. |   | <i>AM 10 : 30 TOUCH<br/>START</i>  |
| 6. |  |  |

NOTE: This is a 24 hour clock. You can switch between AM and PM by touching 1 or 2 after step 4.



## KITCHEN TIMER

Your microwave oven can be used as a kitchen timer. You can set up to 99 minutes, 99 seconds.

Example: To set 3 minutes.

**Touch:**

**Display Shows:**

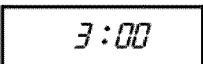
- |    |   |   |
|----|---|---|
| 1. |  | <i>: ENTER TIME IN MIN<br/>AND SEC</i>  |
| 2. |  | <i>3 : 00 TOUCH START</i>   |
| 3. |  | <br><b>TIMER</b> and time counting down. |



## CHILD LOCK

You can use this safety feature to lock the control panel so that children cannot use the oven when you do not want them to and when you are cleaning the oven.

To set CHILD LOCK:

**Touch:**

**Display Shows:**

- |    |  |   |
|----|--|---|
| 1. |   | Time of day.  |
| 2. |  | Touch and hold until LOCKED appears in the display. (approximately 4 seconds) |

To cancel CHILD LOCK:

**Touch:**

**Display Shows:**

- |    |  |  |
|----|--|--|
| 1. |  | Time of day.   |
|    |  | Touch and hold until LOCKED disappears from the display. (approximately 4 seconds) |

ENGLISH

# USING YOUR MICROWAVE OVEN

## SENSOR COOK OPERATION INSTRUCTION

Sensor touch cooking provides exciting new features to make microwaving easier. Sensor menu with all the popular food choices, helps you to reheat perfectly because it has been pre-programmed and can tell how long to reheat food items.

### Categories:

Potato, Rice

Popcorn, Fresh Vegetable

Frozen Vegetable, Frozen Entree

For most Sensor Cooking programs, a table with specific food examples and cooking instructions is provided in the next a few pages.

- The Sensor Touch system works by detecting a build-up of vapor.
- Make sure the door remains closed.
- Once the vapor is detected, two beeps will sound.
- Opening the door or touching the STOP/CLEAR pad before the vapor is detected will abort the process. The oven will stop.
- Before using Sensor Cook, make sure the exterior of the reheating container and the interior of the oven are dry, to assure the best results.
- Room temperature should not exceed 95°F.
- Oven should be plugged in at least 5 minutes before sensor cooking.

## POTATO (EXAMPLE)

SENSOR COOK allows you to cook most of your favorite foods without having to select cooking times and power levels. This oven automatically determines required cooking times for each food item.

**Example: To cook potato**

**Touch:**

**Display Shows:**

1. 

Time of day.

2. 

POTATO

# USING YOUR MICROWAVE OVEN

## SENSOR COOK TABLE

CATEGORY	DIRECTION	AMOUNT
Potato	Pierce each potato with a fork and place on the oven tray around the edge, at least one inch apart.	1 - 4 medium approx. 10 oz. each
Rice	Place rice and twice as much liquid (water or chicken or vegetable stock) in a 2-quart microwavable dish. Cover with plastic wrap. When cooking is complete, allow 10 minutes standing time. Stir for fluffier rice.	1 - 2 cups Use medium or long grain rice. Cook instant rice according to directions on the package.
Popcorn	Place only bag of prepackaged microwave popcorn on the center of turntable	Regular size Use one fresh bag of popcorn
Fresh Vegetable	Prepare as desired, wash, and leave residual water on the vegetables. Place in an appropriately-sized microwave container, cover with plastic wrap and vent.	1 - 4 cups
Frozen Vegetable	Remove from package, rinse off frost under running water. Place in an appropriately-sized microwave container, cover with plastic wrap and vent.	1 - 4 cups
Frozen Entrée	Remove from outer display package. Slit cover. If not in microwave safe container, place on plate, cover with plastic wrap and vent.	10 - 21 oz.

ENGLISH

**NOTE:** If you open the door or press STOP during sensing, the process will be canceled.

## ADD MINUTE

A time-saving pad, this simplified control lets you quickly set and start microwave cooking at 100% power without the need to touch START.

**Example: To cook for 2 minutes.**

**Touch:**

1.  **STOP**  
clear

**Display Shows:**

Time of day.

2.  **add**  
**minute**

Twice

Time counting down  
and power 100

**NOTE:** If you touch **ADD MINUTE**, it will add 1 minute up to 99 min 59 seconds.

# USING YOUR MICROWAVE OVEN

## AUTO DEFROST

Three defrost sequences are preset in the oven. The auto defrost feature provides you with the best defrosting method for frozen foods. The cooking guide will show you which defrost sequence is recommended for the food you are defrosting. For added convenience, the Auto Defrost includes a built-in beep mechanism that reminds you to check, turn over, separate, or rearrange to get best defrost results. Three different defrosting levels are provided.

- 1 MEAT
- 2 POULTRY
- 3 FISH

\*Available weight is 0.1~6.0 lbs.

Example: To defrost 1.2 lbs of ground beef.

**Touch:**



**Display Shows:**

1.  defrost

MEAT TOUCH 1  
POULTRY TOUCH 2  
FISH TOUCH 3

2. 

0 . 0 LBS ENTER  
WEIGHT

3.  and   
to enter the weight

1 . 2 LBS  
TOUCH START

4. 

Time counting down  
and DEFROST.

### NOTE:



When you touch the START pad, the display changes to defrost time count down. The oven will beep during the DEFROST cycle. At this time, open the door and turn, separate, or rearrange the food. Remove any portions that have thawed. Return frozen portions to the oven and touch START to resume the defrost cycle.

### OPERATING TIPS

- For best results, remove fish, shellfish, meat, and poultry from its original closed paper or plastic package (wrapper). Otherwise, the wrap will hold steam and juice close to the foods, which can cause the outer surface of the foods to cook.
- For best results, shape your ground meat into the form of a doughnut before freezing. When defrosting, scrape off thawed meat when the beep sounds and continue defrosting.
- Place foods in a shallow container or on a microwave roasting rack to catch drippings.
- Food should still be somewhat icy in the center when removed from the oven.

# USING YOUR MICROWAVE OVEN

## AUTO DEFROST TABLE





Category	Food to be Defrosted
 <b>1</b> <b>MEAT</b>	<b>Beef</b> Ground beef, Round steak, Cubes for stew, Tenderloin steak, Pot roast, Rib roast, Rump roast, Chuck roast, Hamburger patty <b>Lamb</b> Chops (1 inch thick), Rolled roast <b>Pork</b> Chops ( 1/2 inch thick), Hot dogs, Spareribs, Country-style ribs. Rolled roast, Sausage <b>Veal</b> Cutlets (1 lb., 1/2 inch thick)
 <b>2</b> <b>POULTRY</b>	<b>Poultry</b> Whole (under 4 lbs.), Cut-up, Breasts (boneless) <b>Cornish Hens</b> Whole <b>Turkey</b> Breast
 <b>3</b> <b>FISH</b>	<b>Steaks/Chops</b> Round beef steak, Tenderloin steak Lamb chops (1 inch thick) Pork chops (1/2 inch thick) Veal cutlets (1 lbs, 1/2 inch thick) <b>Fish</b> Fillets, Whole Steaks <b>Shellfish</b> Crab meat, Lobster tails, Shrimp, Scallops

## TIMED COOKING

This feature lets you program a specific cook time and power. For best results, there are 10 power level settings in addition to HIGH power (100%). Refer to the "Microwave Power Level Table" on page 14 for more information.

**NOTE:** If you do not select a power level, the oven will automatically cook at HIGH (100%) power.

**Example: To cook for 5 minutes, 30 seconds at 80% power.**

Touch:	Display Shows:
1. 	: ENTER COOKING TIME
2. 	5 : 30 TOUCH START OR POWER
3. 	ENTER POWER LEVEL 1 TO 10
4. 	5 : 30 POWER 80 TOUCH START
5. 	Time counting down and POWER 80.

ENGLISH

# USING YOUR MICROWAVE OVEN

## MULTI-STAGE COOKING

For best results, some recipes call for different cook powers during different stages of a cook cycle. You can program your oven to switch from one power level to another for up to 2 stages.

**Example: To set a 2-stage cook cycle.**

**Touch:**

**Display Shows:**

1.  **cook time** : ENTER COOKING TIME

2.  **3 0 0**  
to set a 3 minute cook time for first stage. 3 : 00 TOUCH START OR POWER

3.  **power** 3 : 00 ENTER POWER LEVEL 1 TO 10

4.  **8** to set an 80% cook power for the first stage. 3 : 00 POWER 80 TOUCH START

5.  **cook time** : ENTER COOKING TIME

6.  **7 0 0**  
to set a 7 minute cook time for second stage. 7 : 00 TOUCH START OR POWER

7.  **power** 7 : 00 ENTER POWER LEVEL 1 TO 10

8.  **5** to set an 50% cook power for the second stage. 7 : 00 POWER 50 TOUCH START

9.  **START** Time counting down and POWER 80.

10. When the first stage is over, you will hear two short tones as the oven begins the second cook stage.

## MICROWAVE POWER LEVELS

Your microwave oven has 10 cook power levels to let you cook or heat a wide variety of foods. Refer to the table below for suggestions:

**Microwave Power Level Table**

Power Level	Use
10 (High)	<ul style="list-style-type: none"> <li>Boiling water.</li> <li>Making candy.</li> <li>Cooking poultry pieces, fish, &amp; vegetables.</li> <li>Cooking tender cuts of meat.</li> <li>Whole poultry.</li> </ul>
9	<ul style="list-style-type: none"> <li>Reheating rice, pasta, &amp; vegetables.</li> </ul>
8	<ul style="list-style-type: none"> <li>Reheating prepared foods quickly.</li> <li>Reheating sandwiches.</li> </ul>
7	<ul style="list-style-type: none"> <li>Cooking egg, milk, &amp; cheese dishes.</li> <li>Cooking cakes, breads.</li> <li>Melting chocolate.</li> </ul>
6	<ul style="list-style-type: none"> <li>Cooking veal.</li> <li>Cooking whole fish.</li> <li>Cooking puddings &amp; custard.</li> </ul>
5	<ul style="list-style-type: none"> <li>Cooking ham, whole poultry, &amp; lamb.</li> <li>Cooking rib roast, sirloin tip.</li> </ul>
4	<ul style="list-style-type: none"> <li>Thawing meat, poultry, &amp; seafood.</li> </ul>
3	<ul style="list-style-type: none"> <li>Cooking less tender cuts of meat.</li> <li>Cooking pork chops, roast.</li> </ul>
2	<ul style="list-style-type: none"> <li>Taking chill out of fruit.</li> <li>Softening butter.</li> </ul>
1	<ul style="list-style-type: none"> <li>Keeping casseroles &amp; main dishes warm.</li> <li>Softening butter &amp; cream cheese.</li> </ul>
0	<ul style="list-style-type: none"> <li>Standing time.</li> </ul>

# USING YOUR MICROWAVE OVEN

**WARNING: Do not use aluminum foil during cooking cycle.**

## COOKING TIPS

### Meat

1. No special techniques are required. Meat should be prepared as with conventional cooking. Season if desired. Always thoroughly defrost meat before cooking.
2. Place the meat on a microwave roasting rack or microwave-proof plate and place on the turntable.
3. Cook according to the Meat Cooking Table (below). Use the longer time for large cuts of meats and the shorter time for small cuts of meats. For thicker chops, use the longer time.
4. Turn the meat once halfway through the cooking time.
5. **Let stand** for 5-10 minutes wrapped in foil after cooking. The standing time is very important as it completes the cooking process.
6. Make sure meat, especially pork, is thoroughly cooked before eating.

### Meat Cooking Table

Meat	Microwave Power	Cooking Time Per Pound
<b>BEEF</b>		
Standing/Rolled Rib		
– Medium	8	9½ to 11½ minutes
– Well-done	8	11½ to 14 minutes
Ground Beef (to brown for casserole)	HIGH(100%)	6½ to 9½ minutes
Hamburgers, Fresh or defrosted (4 oz. each)		
– 2 patties	HIGH(100%)	2½ to 4½ minutes
– 4 patties	HIGH(100%)	3½ to 5½ minutes
<b>PORK</b>		
Loin, Leg		
Bacon	8	12½ to 16½ minutes
– 4 slices	HIGH(100%)	2½ to 3½ minutes
– 6 slices	HIGH(100%)	3½ to 4½ minutes

**NOTE:** The times listed above are only a guide. Allow for difference in individual tastes and preferences. The times may also vary due to the shape, cut, and composition of the food.

### Poultry

1. No special techniques are required. Poultry should be prepared as with conventional cooking. Season if desired.
2. Poultry should be thoroughly defrosted. Remove giblets and any metal clamps.
3. Prick the skin and brush lightly with vegetable oil unless the poultry is self-basting.
4. All poultry should be placed on a microwave roasting rack or a microwave-proof plate and placed on the turntable.
5. Cook according to the instructions in the Poultry Cooking Table below. Turn over halfway through the cooking time. Because of its shape, poultry has a tendency to cook unevenly, especially in very bony parts. Turning during roasting helps to cook these areas evenly.
6. **Let stand** for 5-10 minutes wrapped in foil after cooking before carving. The standing time is very important, as it completes the cooking process.
7. Make sure poultry is thoroughly cooked before eating. Whole poultry is completely cooked when the juices run clear from the inside thigh when it is pierced with a sharp knife. Poultry pieces should be pierced with a sharp knife through the thickest part to ensure that the juices are clear and the flesh is firm.

### Poultry Cooking Table

Poultry	Microwave Power	Cooking Time Per Pound
<b>CHICKEN</b>		
Whole	8	11 to 15 minutes
Breast (boned)	8	10 to 14 minutes
Portions	8	11 to 17 minutes
<b>TURKEY</b>		
Whole	8	11 to 15 minutes

#### NOTES:

- The times listed above are only a guide. Allow for difference in individual tastes and preferences. The times may also vary due to the shape, cut, and composition of the food.
- If whole poultry is stuffed, the weight of the stuffed bird should be used when calculating the cooking time.

# USING YOUR MICROWAVE OVEN

## COOKING TIPS (continued)

### Fish

1. Arrange fish in a large shallow non-metallic dish or casserole.
2. Cover with pierced microwave plastic wrap or casserole lid.
3. Place the dish on the turntable.
4. Cook according to the instructions in the Fresh Fish Cooking Table below. Flakes of butter can be added to the fish if desired.
5. Let stand as directed in the Cooking Table before serving.
6. After standing time, check to see that the fish is thoroughly cooked. The fish should be opaque and flake easily.

### Fresh Fish Cooking Table

Fish	Microwave Power	Cooking Time Per Pound	Butter	Standing Time
Fish Fillets	HIGH	4½ to 8 minutes	Add 15 to 30 ml (1 to 2 tbsp lemon juice)	2 to 3 minutes
Whole Mackerel, Cleaned and Prepared	HIGH	4½ to 8 minutes	–	3 to 4 minutes
Whole Trout, Cleaned and Prepared	HIGH	5½ to 9 minutes	–	3 to 4 minutes
Salmon Steaks	HIGH	5½ to 8 minutes	Add 15 to 30 ml (1 to 2 tbsp lemon juice)	3 to 4 minutes



# TROUBLESHOOTING

## Questions and Answers

### Operation

Question	Answer
Why is the oven light not on during cooking?	There may be several reasons why the oven light is not on. Have you: <ul style="list-style-type: none"> <li>• Set a cooking time?</li> <li>• Touched START?</li> </ul>
Why does steam come out of the air exhaust vent?	Steam is normally produced during cooking. The microwave oven has been designed to vent this steam.
Will the microwave oven be damaged if it operates empty?	Yes. Never operate the oven empty or without the glass turntable.
Does microwave energy pass through the viewing screen in the door?	No. The metal screen bounces the energy back to the oven cavity. The holes (or ports) allow only light to pass through. They do not let microwave energy pass through.
Why does a tone sound when a pad on the control panel is touched?	The tone tells you that the setting has been entered.
Can my microwave oven be damaged if food is cooked for too long?	Like any other cooking appliance, it is possible to overcook food to the point that the food creates smoke and even possibly fire, and damage to the inside of the oven. It is always best to be near the oven while you are cooking.
When the oven is plugged into wall outlet for the first time, it does not work properly. What is wrong?	The microcomputer controlling your oven may temporarily become scrambled and fail to function as programmed when you plug in for the first time or when power resumes after a power interruption. Unplug the oven from the 120 volt household outlet and then plug it back in to reset the microcomputer.
Why do I see light reflection around the outer case?	This light is from the oven light which is located between the oven cavity and the outer wall of the oven.
What are the various sounds I hear when the microwave oven is operating?	The clicking sound is caused by a mechanical switch turning the microwave oven's magnetron ON and OFF. The heavy hum and clunk is from the change in power the magnetron draws as it is turned ON and OFF by a mechanical switch. The change in blower speed is from the change in line voltage caused by the magnetron being turned ON and OFF.

# TROUBLESHOOTING

## Questions and Answers (continued)

### Food

Question	Answer
What is wrong when baked foods have a hard, dry, brown spot?	A hard, dry, brown spot indicates overcooking. Shorten the cooking or reheating time.
Why do eggs sometimes pop?	When baking, frying, or poaching eggs, the yolk may pop due to steam build-up inside the yolk membrane. To prevent this, simply pierce the yolk with a wooden toothpick before cooking. <b>CAUTION:</b> Never microwave eggs in the shell.
Why are scrambled eggs sometimes a little dry after cooking?	Eggs will dry out when they are overcooked, even if the same recipe is used each time. The cooking time may need to be varied for one of these reasons: <ul style="list-style-type: none"> <li>• Eggs vary in size.</li> <li>• Eggs are at room temperature one time and at refrigerator temperature another time.</li> <li>• Eggs continue cooking during standing time.</li> </ul>
Is it possible to pop popcorn in a microwave oven?	Yes, if using one of the two methods described below: <ol style="list-style-type: none"> <li>(1) microwave-popping devices designed specifically for microwave cooking</li> <li>(2) prepackaged commercial microwave popcorn that is made for specific times and power output needed</li> </ol> <p><b>Follow exact directions given by each manufacturer for its popcorn popping product and do not leave the oven unattended while the corn is being popped. If corn fails to pop after the suggested time, discontinue cooking. Overcooking could result in an oven fire.</b></p> <p><b>CAUTION:</b></p> <ul style="list-style-type: none"> <li>• <b>Never use a brown paper bag for popping corn or attempt to pop leftover kernels.</b></li> <li>• <b>Do not pop prepackaged commercial microwave popcorn directly on the glass turntable. To avoid excessive heating of the glass turntable, place the popcorn bag on a plate.</b></li> </ul>
Why do baked apples sometimes burst during cooking?	The peel has not been removed from the top half of each apple to allow for expansion of the interior of the apple during cooking. As in conventional cooking methods, the interior of the apple expands during the cooking process.
Why do baked potatoes sometimes burn during cooking?	If the cooking time is too long, fire could result. At the end of the recommended cooking time, potatoes should be slightly firm. <b>CAUTION: Do not overcook.</b>
Why is a standing time recommended after microwave cooking time is over?	Standing time allows foods to continue cooking evenly for a few minutes after the actual microwave oven cooking cycle. The amount of standing time depends upon the density of the foods.
Why is additional time required for cooking food stored in the refrigerator?	As in conventional cooking, the initial temperature of food affects total cooking time. You need more time to cook food taken out of a refrigerator than for food at room temperature.

# TROUBLESHOOTING

## BEFORE CALLING FOR SERVICE

You can often correct operating problems yourself. If your microwave oven fails to work properly, locate the operating problem in the list below and try the solutions listed for each problem.

If the microwave oven still does not work properly, contact the nearest Sears Authorized Service Center. Sears Authorized Service Centers are fully equipped to handle your service requirements.

Problem	Possible Causes
Oven does not start	<ul style="list-style-type: none"> <li>• Is the power cord plugged in?</li> <li>• Is the door closed?</li> <li>• Is the cooking time set?</li> </ul>
Arcing or Sparking	<ul style="list-style-type: none"> <li>• Are you using approved cookware?</li> <li>• Is the oven empty?</li> </ul>
Incorrect time of day	<ul style="list-style-type: none"> <li>• Have you tried to reset the time of day?</li> </ul>
Unevenly Cooked Foods	<ul style="list-style-type: none"> <li>• Are you using approved cookware?</li> <li>• Is the glass turntable in the oven?</li> <li>• Did you turn or stir the food while it was cooking?</li> <li>• Were the foods completely defrosted?</li> <li>• Was the time/cooking power level correct?</li> </ul>
Overcooked Foods	<ul style="list-style-type: none"> <li>• Was the time/cooking power level correct?</li> </ul>
Undercooked Foods	<ul style="list-style-type: none"> <li>• Are you using approved cookware?</li> <li>• Were the foods completely defrosted?</li> <li>• Was the time/cooking power level correct?</li> <li>• Are the ventilation ports clear?</li> </ul>
Improper Defrosting	<ul style="list-style-type: none"> <li>• Are you using approved cookware?</li> <li>• Was the time/cooking power level correct?</li> <li>• Did you turn or stir the food during the defrosting cycle?</li> </ul>

ENGLISH

### FEDERAL COMMUNICATIONS COMMISSION RADIO FREQUENCY INTERFERENCE STATEMENT (U.S.A. ONLY)

**WARNING:**

This equipment generates and uses ISM frequency energy and if not installed and used properly, that is in strict accordance with the manufacturer's instructions, may cause interference to radio and television reception. It has been type tested and found to comply with limits for ISM Equipment pursuant to part 18 of FCC Rules, which are designed to provide reasonable protection against such interference in a residential installation.

However, there is no guarantee that interference will not occur in a particular installation. If this equipment does cause interference to radio or television reception, which can be determined by turning the equipment off and on, the user is encouraged to try to correct the interference by one or more of the following:

- Reorient the receiving antenna of the radio or television.
- Relocate the Microwave Oven with respect to the receiver.
- Move the microwave oven away from the receiver.
- Plug the microwave oven into a different outlet so that the microwave oven and the receiver are on different branch circuits.

**The manufacturer** is not responsible for any radio or TV interference caused by **unauthorized modification** to this microwave oven. It is the responsibility of the user to correct such interference.

# Get it fixed, at your home or ours!

## Your Home

For repair - in your home - of all major brand appliances, lawn and garden equipment, or heating and cooling systems, **no matter who made it, no matter who sold it!**

For the replacement parts, accessories and owner's manuals that you need to do-it-yourself.

For Sears professional installation of home appliances and items like garage door openers and water heaters.

**1-800-4-MY-HOME®** (1-800-469-4663)

Call anytime, day or night (U.S.A. and Canada)

[www.sears.com](http://www.sears.com)    [www.sears.ca](http://www.sears.ca)

---

## Our Home

For repair of carry-in items like vacuums, lawn equipment, and electronics, call or go on-line for the location of your nearest **Sears Parts & Repair Center.**

**1-800-488-1222**

Call anytime, day or night (U.S.A. only)

[www.sears.com](http://www.sears.com)

---

To purchase a protection agreement on a product serviced by Sears:

**1-800-827-6655** (U.S.A.)

**1-800-361-6665** (Canada)

---

Para pedir servicio de reparación a domicilio, y para ordenar piezas:

**1-888-SU-HOGAR<sup>SM</sup>**

(1-888-784-6427)

Au Canada pour service en français:

**1-800-LE-FOYER<sup>MC</sup>**

(1-800-533-6937)

[www.sears.ca](http://www.sears.ca)

# SEARS

## Free Manuals Download Website

<http://myh66.com>

<http://usermanuals.us>

<http://www.somanuals.com>

<http://www.4manuals.cc>

<http://www.manual-lib.com>

<http://www.404manual.com>

<http://www.luxmanual.com>

<http://aubethermostatmanual.com>

Golf course search by state

<http://golfingnear.com>

Email search by domain

<http://emailbydomain.com>

Auto manuals search

<http://auto.somanuals.com>

TV manuals search

<http://tv.somanuals.com>