

Use & Care Guide

Manual de Uso y Cuidado

English / Español

Models/Modelos: 790.4890\*, 790.4880\*

# Kenmore Elite®

## Microwave/Wall Oven Combination

## Combinación Microondas/Horno de Pared

\* = Color number, número de color

P/N 318205334B (1205)

Sears Brands Management Corporation

Hoffman Estates, IL 60179 U.S.A.

[www.kenmore.com](http://www.kenmore.com)

[www.sears.com](http://www.sears.com)



## Table of Contents

Kenmore Elite Warranty.....	2	Microwave Manual Operation .....	13
Product Record .....	2	Microwave Operating Instructions .....	14-23
Serial Plate Location .....	2	Lower Oven Operation Instructions.....	24-33
<b>IMPORTANT SAFETY INSTRUCTIONS</b> .....	<b>3-5</b>	User Preferences.....	<b>34</b>
Microwave / Wall Oven Features .....	6	Lower Oven Self-Cleaning Cycle .....	<b>35-36</b>
Microwave Oven Important Informations .....	7-8	Microwave General Care & Cleaning .....	<b>37</b>
Control Pad Features .....	9	Lower Oven General Care & Cleaning.....	<b>38-40</b>
Control Pan Settings & Microwave Menu Label.....	10	Before You Call.....	<b>41-43</b>
Oven Vent and Racks .....	11	Protection Agreements.....	<b>45</b>
Getting Started .....	12	Sears Service.....	<b>46</b>

## Please carefully read and save these instructions

This Use & Care Manual contains general operating instructions for your appliance and feature information for several models. Your product **may not** have all the described features. The graphics shown are representative. The graphics on your appliance may not look exactly like those shown. Common sense and caution must be practiced when installing, operating and maintaining any appliance.

## Kenmore Elite Warranty

When installed, operated and maintained according to all instructions supplied with the product, if this appliance fails due to a defect in material and workmanship within one year from the date of purchase, call 1-800-4-MY-HOME® to arrange for free repair.

This warranty applies for only 90 days from the date of purchase if this appliance is ever used for other than private family purposes.

### This warranty covers only defects in material and workmanship. Sears will NOT pay for:

1. Cracks in a ceramic glass cooktop that are not a result of thermal shock.
2. Stains and scratches on a ceramic glass cooktop resulting from accident or improper operation or maintenance.
3. Expendable items that can wear out from normal use, including but not limited to filters, belts, light bulbs, and bags.
4. A service technician to instruct the user in correct product installation, operation or maintenance.
5. A service technician to clean or maintain this product.
6. Damage to or failure of this product if it is not installed, operated or maintained according to the all instructions supplied with the product.
7. Damage to or failure of this product resulting from accident, abuse, misuse or use for other than its intended purpose.
8. Damage to or failure of this product caused by the use of detergents, cleaners, chemicals or utensils other than those recommended in all instructions supplied with the product.
9. Damage to or failure of parts or systems resulting from unauthorized modifications made to this product.

### Disclaimer of implied warranties; limitation of remedies

Customer's sole and exclusive remedy under this limited warranty shall be product repair as provided herein. Implied warranties, including warranties of merchantability or fitness for a particular purpose, are limited to one year or the shortest period allowed by law. Sears shall not be liable for incidental or consequential damages. Some states and provinces do not allow the exclusion or limitation of incidental or consequential damages, or limitation on the duration of implied warranties of merchantability or fitness, so these exclusions or limitations may not apply to you.

This warranty applies only while this appliance is used in the United States or Canada.

This warranty gives you specific legal rights, and you may also have other rights which vary from state to state.

**Sears Brands Management Corporation, Hoffman Estates, IL 60179 - Sears Canada Inc., Toronto, Ontario, Canada M5B 2B8**

## Product Record

In this space below, record the date of purchase, model and serial number of your product. You will find the model and serial number printed on the serial plate.

Model No. **790.** \_\_\_\_\_

Serial No. \_\_\_\_\_

Date of purchase \_\_\_\_\_

Save these instructions and your sales receipt for future reference.

## Serial Plate Location

You will find the model and serial number printed on the serial plate. The serial plate is located along the interior side trim and visible when the lower oven door is opened.

Remember to record the serial number for future reference.

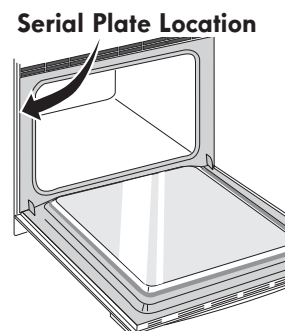

# IMPORTANT SAFETY INSTRUCTIONS

Read all instructions before using this appliance.

This manual contains important safety symbols and instructions. Please pay attention to these symbols and follow all instructions given.

**⚠ WARNING** This symbol will help alert you to situations that may cause serious bodily harm, death or property damage.

**⚠ CAUTION** This symbol will help alert you to situations that may cause bodily injury or property damage.



## PRECAUTIONS TO AVOID POSSIBLE EXPOSURE TO EXCESSIVE MICROWAVE ENERGY

For your safety the information in this manual must be followed to minimize the risk of fire or explosion or to prevent property damage, personal injury or loss of life.

- **Do Not Attempt** to operate this microwave oven with the door open since open-door operation can result in harmful exposure to microwave energy. It is important not to defeat or tamper with the safety interlocks.
  - **Do Not Place** any object between the microwave oven front face and the door or allow soil or cleaner residue to accumulate on sealing surfaces.
  - **Do Not Operate** the microwave oven if it is damaged. It is particularly important that the microwave oven door close properly and that there is no damage to the: **1.** door (bent); **2.** hinges and latches (broken or loosened); **3.** door seals and sealing surfaces.
  - **The Oven Should Not** be adjusted or repaired by anyone except properly qualified service personnel.
- **Remove all tape and packaging before using the appliance.** Destroy the carton and plastic bags after unpacking the appliance. Never allow children to play with packaging material.
  - **Proper Installation.** Be sure your appliance is properly installed and grounded by a qualified technician in accordance with the National Fuel Gas Code ANSI Z223- latest edition, or in Canada CAN/CGA B149.1 and CAN/GGA B149.2, and the National Electrical Code ANSI/NFPA No.70-latest edition, or in Canada CSA Standard C22.1, Canadian Electrical Code, Part 1, and local code requirements. Install only per installation instructions provided in the literature package for this appliance.
- Sears Parts & Repair is the recommended repair service for this appliance. Know how to disconnect the electrical power to the appliance at the circuit breaker or fuse box in case of an emergency.
- **User Servicing.** Do not repair or replace any part of the appliance unless specifically recommended in the manuals. All other servicing should be done only by a qualified technician to reduce the risk of personal injury and damage to the appliance.

- **Never modify or alter the construction of an appliance by removing panels, wire covers or any other part of the product.**
- **Remove the oven door from any unused appliance if it is to be stored or discarded.**

**⚠ WARNING** Stepping, leaning or sitting on the doors of this appliance can result in serious injuries and also cause damage to the unit. Do not allow children to climb or play around the unit. The weight of a child on an open door may cause the appliance to tip, resulting in serious burns or other injury.

- **Protective liners**—Do not use aluminum foil to line the oven bottom. Only use aluminum foil as recommended in this manual. Improper installation of these liners may result in risk of electric shock, or fire.
- **Storage in Appliance. Flammable materials should not be stored near surface units.** This includes paper, plastic and cloth items, such as cookbooks, plasticware and towels, as well as flammable liquids. Do not store explosives, such as aerosol cans, on or near the appliance.

**⚠ WARNING** Do not use the oven or the microwave oven for storage.

**⚠ CAUTION** Do not store items of interest to children in the cabinets above an appliance. Children climbing on the appliance to reach items could be seriously injured.

- **Do not leave children alone. Children should not be left alone or unattended in the area where an appliance is in use.** They should never be allowed to sit or stand on any part of the appliance.
- **DO NOT TOUCH HEATING ELEMENTS OR INTERIOR SURFACES OF OVENS OR ANY AREAS NEAR THESE ZONE.** All oven heating elements may be hot even though they are



### ⚠ WARNING

- All wall ovens can tip.
- Injury to persons could result.
- Install mounting screws packed with wall oven.



• See Installation Instructions. To reduce the risk of tipping, the wall oven must be secured by properly installed mounting screws

provided with the wall oven. Refer to the Installation Instructions for proper mounting screws installation.

# IMPORTANT SAFETY INSTRUCTIONS

dark in color. Areas near surface zones may become hot enough to cause burns. During and after use, do not touch, or let clothing or other flammable materials touch these areas until they have had sufficient time to cool. Among these surfaces near these openings, oven doors and windows).

- **Wear Proper Apparel.** Loose-fitting or hanging garments should never be worn while using the appliance. Do not let clothing or other flammable materials contact hot surfaces.

**⚠ WARNING** Never use your appliance for warming or heating the room.

- **Do Not Use Water or Flour on Grease Fires.** Smother the fire with a pan lid, or use baking soda, a dry chemical or foam-type extinguisher.
- **When heating fat or grease, watch it closely.** Fat or grease may catch fire if allowed to become too hot.
- **Use Only Dry Potholders.** Moist or damp potholders on hot surfaces may result in burns from steam. Do not let the potholders touch hot heating surface units. Do not use a towel or other bulky cloth instead of a potholder.
- **Do Not Heat Unopened Food Containers.** Buildup of pressure may cause the container to burst and result in injury.

**IMPORTANT—Do not attempt to operate the appliance during a power failure.** If power fails, always turn off the appliance. If the appliance is not turned off and the power resumes, it will begin to operate again. Once the power resumes, reset the clock and oven function.

## IMPORTANT INSTRUCTIONS FOR USING YOUR MICROWAVE

### ⚠ WARNING

When using electrical appliances, basic safety precautions should be followed to reduce the risk of burns, electric shock, fire, injury to persons or exposure to excessive microwave energy:

- **READ ALL** instructions before using the appliance.
- Read and follow the specific **“PRECAUTIONS TO AVOID POSSIBLE EXPOSURE TO EXCESSIVE MICROWAVE ENERGY”**.
- Install or locate this appliance only in accordance with the provided installation instructions.
- Some products such as whole eggs and sealed containers—for example, closed glass jars—are able to explode and should not be heated in this microwave oven.
- Use this appliance **ONLY** for its intended use as described in this manual. Do not use corrosive chemicals or vapors in this appliance. This type of oven is specifically designed to heat, cook or dry food. It is not designed for industrial or laboratory use.
- As with any appliance, **CLOSE SUPERVISION** is necessary when used by **CHILDREN** or **DISABLED PERSON**.

- This appliance, including power cord, must be serviced **ONLY** by qualified service personnel. Contact nearest Authorized Servicer for examination, repair or adjustment.
- **DO NOT** cover or block any openings on the appliance.
- **DO NOT** store or use this appliance outdoors.
- **DO NOT** use this product near water—for example, near a kitchen sink, in a wet basement or near a swimming pool, or similar locations.
- Oversized foods or oversized metal utensils should **NOT** be inserted in a microwave oven as they may create a fire or risk of electric shock.
- **DO NOT** clean with metal scouring pads. Pieces can burn off the pad and touch electrical parts involving a risk of electric shock.
- **DO NOT** use paper products when appliance is operated in the convection or mix mode.
- **DO NOT** cover racks or any other part of the microwave oven with metal foil. This will cause overheating of the oven.
- Review the door cleaning instructions.

### ⚠ CAUTION

To reduce the risk of fire in the microwave oven cavity:

- Do not overcook food. Carefully attend appliance when paper, plastic or other combustible materials are placed inside the microwave oven to facilitate cooking.
- Remove wire twist-ties from paper or plastic bags before placing bag in microwave oven.
- **If materials inside the microwave oven should ignite, keep microwave oven door closed, turn microwave oven off and disconnect the power cord or shut off power at the fuse or circuit breaker panel.**
- **DO NOT** use the cavity for storage purposes. Do not leave paper products, cooking utensils or food in the cavity when not in use.

Liquids, such as water, coffee or tea are able to be overheated beyond the boiling point without appearing to be boiling. Visible bubbling or boiling when the container is removed from the microwave oven is not always present.

**THIS COULD RESULT IN VERY HOT LIQUIDS SUDDENLY BOILING OVER WHEN A SPOON OR OTHER UTENSIL IS INSERTED INTO THE LIQUID.**

To reduce the risk of injury to persons:

- **DO NOT** overheat the liquid.
- Stir the liquid both before and halfway through heating it.
- Do not use straight-sided containers with narrow necks. Use a wide-mouthed container.
- After heating, allow the container to stand in the microwave oven at least for 20 seconds before removing the container.
- Use extreme care when inserting a spoon or other utensil into the container.
- If the microwave oven light fails, consult a Sears parts & repair center.

# IMPORTANT SAFETY INSTRUCTIONS

## IMPORTANT INSTRUCTIONS FOR USING YOUR LOWER OVEN

- **Use Care When Opening an Oven Door**—Stand to the side of the appliance when opening the door of a hot oven. Let hot air or steam escape before you remove or replace food in the oven.
- **Keep Oven Vent Ducts Unobstructed.** The wall oven is vented at the upper control panel or at the center trim depending of the model. Touching the surfaces in this area when the wall oven is operating may cause severe burns. Also, do not place plastic or heat-sensitive items near the oven vent. These items could melt or ignite.
- **Placement of Oven Racks.** Always place oven racks in desired location while oven is cool. If rack must be moved while oven is hot, use extreme caution. Use pot holders and grasp the rack with both hands to reposition. Do not let pot holders contact the hot oven element or interior of the oven. Remove all utensils from the rack before removing rack.
- **Do not use a broiler pan without its insert.** Broiler pan and grid allow dripping fat to drain and be kept away from the high heat of the broiler.
- **Do not cover the broiler grid or oven bottom with aluminum foil. Exposed fat and grease could ignite.**
- **Do not touch a hot oven light bulb with a damp cloth.** Doing so could cause the bulb to break. Disconnect the appliance or shut off the power to the appliance before removing and replacing the bulb.

## IMPORTANT INSTRUCTIONS FOR CLEANING YOUR APPLIANCE

- **Clean the appliance regularly to keep all parts free of grease that could catch fire.** Exhaust fan ventilation hoods and grease filters should be kept clean. Do not allow grease to accumulate. Greasy deposits in the fan could catch fire. Refer to the hood manufacturer's instructions for cleaning.
- **Kitchen cleaners and aerosols**—Always follow the manufacturer's recommended directions for use. Be aware that excess residue from cleaners and aerosols may ignite causing damage and injury.
- **Clean ventilating hoods frequently**—Grease should not be allowed to accumulate on the hood or filter. Follow manufacturer's instructions for cleaning.

## SELF-CLEANING WALL OVEN MODELS

- **Clean in the self-cleaning cycle only the parts of the appliance listed in this Owner's Guide.** Before using the self-cleaning cycle of the appliance, remove all utensils stored in the appliance.
- **Do not clean the oven door gasket.** The door gasket is essential for a good seal. Care should be taken not to rub, damage or move the gasket.
- **Do not use oven cleaners.** No oven cleaner or oven liner protective coating of any kind should be used in or around any part of the appliance.

**CAUTION** The health of some birds is extremely sensitive to the fumes given off during the self-clean cycle of any wall oven. Move birds to another well ventilated room.

---

## IMPORTANT SAFETY NOTICE

The California Safe Drinking Water and Toxic Enforcement Act requires the Governor of California to publish a list of substances known to the state to cause cancer, birth defects or other productive harm, and requires businesses to warn customers of potential exposure to such substances.

---

## FEDERAL COMMUNICATIONS COMMISSION RADIO FREQUENCY INTERFERENCE STATEMENT (U.S.A. ONLY)

This equipment generates and uses ISM frequency energy and if not installed and used properly, that is in strict accordance with the manufacturer's instructions, may cause interference to radio and television reception. It has been type tested and found to comply with limits for ISM Equipment pursuant to part 18 of FCC Rules, which are designed to provide reasonable protection against such interference in a residential installation.

However, there is no guarantee that interference will not occur in a particular installation. If this equipment does cause interference to radio or television reception, which can be determined by turning the equipment off and on, the user is encouraged to try to correct the interference by one or more of the following:

- Reorient the receiving antenna of the radio or television.
- Relocate the microwave oven with respect to the receiver.
- Move the microwave oven away from the receiver.
- Plug the microwave oven into a different outlet so that the microwave oven and the receiver are on different branch circuits.

**The manufacturer** is not responsible for any radio or television interference caused by **unauthorized modification** to this microwave oven. It is the responsibility of the user to correct such interference.

## SAVE THESE INSTRUCTIONS FOR FUTURE REFERENCES

# Microwave / Wall Oven Features

Note: The features of your oven will vary according to model.

## YOUR MICROWAVE / WALL OVEN FEATURES AT A GLANCE

1. Glass touch control panel.
2. Stainless steel micro-wave upper oven interior.
3. Decorative accent light.
4. Micro-wave convection fan (hidden).
5. Micro-wave oven ventilation.
6. Full-width door with tinted window glass.
7. Large metal door handles.
8. Self-cleaning lower oven interior with halogen lighting system.
9. Dual or single convection fan & element system (depending on model).
10. Porcelain coated handle oven racks.
11. Porcelain coated offset oven rack.
12. Painted or stainless steel oven exterior panels & trim.
13. Broil element.
14. Hidden bake element.
15. Automatic interior oven door light switch.
16. Self-cleaning lower oven ventilation.
17. Self-clean oven door latch.
18. A **Popcorn Tray** (NordicWare®) made from heavy thermoset polyester (required for cooking popcorn).
  - Ribbed side for popcorn, bacon and meat
  - Smooth side for pizza and nachos
  - Oven safe up to 400°F
19. Removable turntable - Place the turntable on the turntable support securely. The turntable will rotate clockwise or counterclockwise. Only remove for cleaning.
20. Removable turntable support - Carefully place the turntable support in the center of the oven floor.
21. Low rack.
22. High rack.

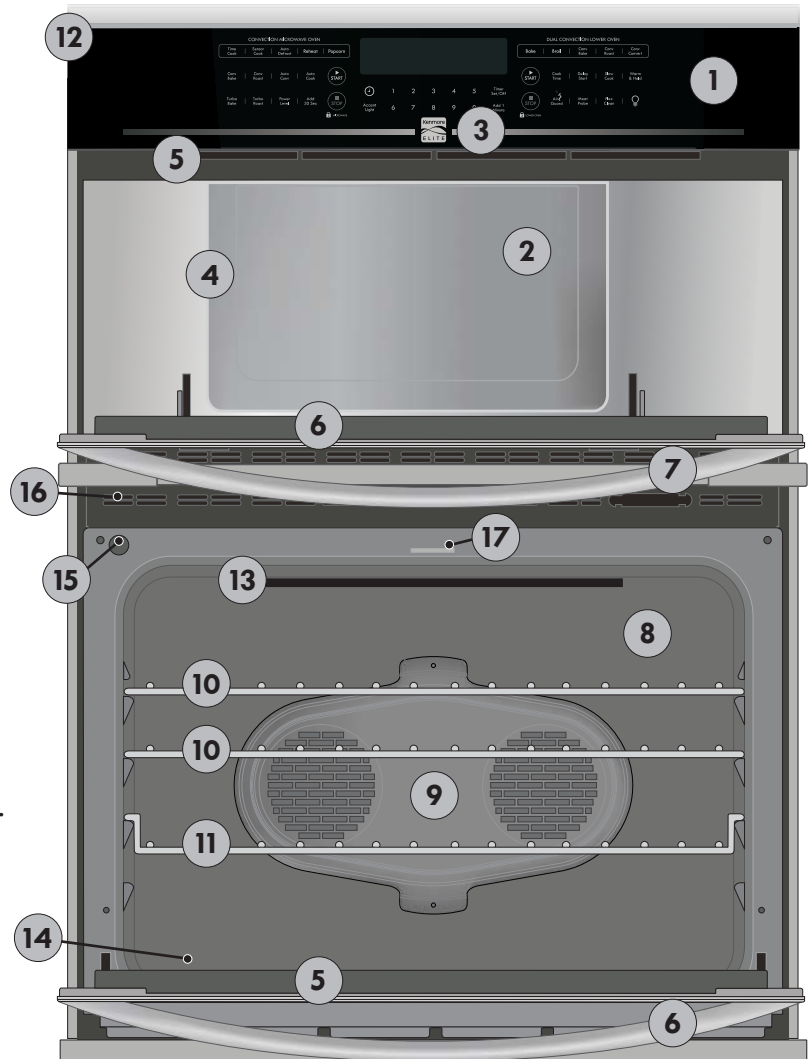

## ACCESSORIES

The accessory **18** from the list above is designed especially for microwave popcorn to cook popcorn quickly and efficiently. The accessories **21** and **22** are designed especially for use in the microwave oven for convection, turbo or broil cooking only. **DO NOT USE FOR MICROWAVE ONLY COOKING.** Do not substitute similar types or racks for these specially designed ones.

High rack (Baking rack)- for convection and turbo bake.

- This rack is placed on the turntable for two-level cooking, such as layer cakes, muffins, etc.

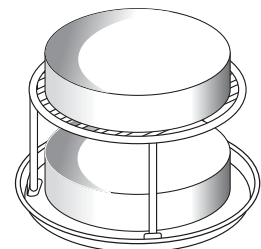

Low rack (Broiling rack)- for convection, broiling or turbo roast.

- Place on the turntable and use for roasting or broiling to allow juices to drain away from food.

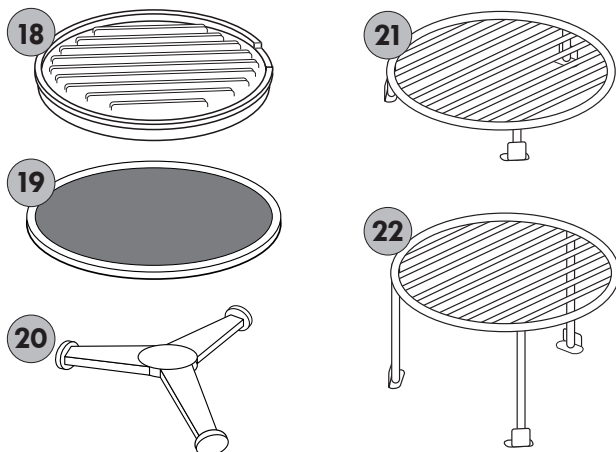
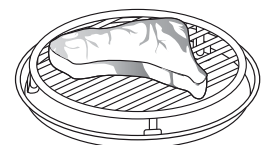

# Microwave Oven Important Information

## RADIO OR TV INTERFERENCE

Should there be any interference caused by the microwave oven to your radio or TV, check that the microwave oven is on a different electrical circuit, relocate the radio or TV as far away from the microwave oven as feasible or check position and signal of receiving antenna.

## ABOUT YOUR MICROWAVE OVEN

This Use and Care Manual is valuable: read it carefully and always save it for reference.

A good microwave cookbook is a valuable asset. Check it for microwave cooking principles, techniques, hints and recipes.

**NEVER** use the microwave oven without the turntable and support nor turn the turntable over so that a large dish could be placed in the microwave oven. The turntable will turn both clockwise and counterclockwise.

**ALWAYS** have food in the microwave oven when it is on to absorb the microwave energy.

When using the microwave oven at power levels below 100%, you may hear the magnetron cycling on and off. It is normal for the exterior of the microwave oven to be warm to the touch when cooking or reheating.

Condensation is a normal part of microwave cooking. Room humidity and the moisture in food will influence the amount of moisture that condenses in the microwave oven. Generally, covered foods will not cause as much condensation as uncovered ones. Ventilation openings must not be blocked.

The microwave oven is for food preparation only. It should not be used to dry clothes or newspapers.

All microwave ovens are rated by using the IEC Test Procedure at 1200 watts. In using recipes or package directions, check food a minute or two before the minimum time setting elapses and add time accordingly.

## ABOUT MICROWAVE COOKING

- Arrange food carefully. Place thickest areas towards outside of dish.
- Watch cooking time. Cook for the shortest amount of time indicated and add more as needed. Food severely overcooked can smoke or ignite.
- Cover foods while cooking. Check recipe or cookbook for suggestions: paper towels, wax paper, microwave plastic wrap or a lid. Covers prevent spattering and help foods to cook evenly.
- Shield with small flat pieces of aluminum foil any thin areas of meat or poultry to prevent overcooking before dense, thick areas are cooked thoroughly.
- Stir foods from outside to center of dish once or twice during cooking, if possible.
- Turn foods over once during microwaving to speed cooking of such foods as chicken and hamburgers. Large items like roasts must be turned over at least once.
- Rearrange foods such as meatballs halfway through cooking both from top to bottom and from the center of the dish to the outside.
- Use standing time. Always allow food to stand in or out of the oven after cooking power stops. Standing time after defrosting or cooking allows the temperature to evenly spread throughout the food, improving the cooking results. For inside oven standing time, you can program a "0"

power stage of cooking cycle. See Multiple Stage Cooking.

- Check for doneness. Look for signs indicating that cooking temperatures have been reached.

### Doneness signs include:

- Food steams throughout, not just at edge.
- Center bottom of dish is very hot to the touch.
- Poultry thigh joints move easily.
- Meat and poultry show no pinkness.
- Fish is opaque and flakes easily with a fork.

## ABOUT FOODS

- Do not pop popcorn in your microwave oven unless in a special microwave popcorn accessory or unless you use popcorn labeled for use in microwave ovens.
- Some products such as whole eggs and sealed containers—for example, closed jars—will explode and should not be heated in this microwave oven. Such use of the microwave oven could result in injury.
- Do not boil eggs in a microwave oven. Pressure will build up inside egg yolk and will cause it to burst, possibly resulting in injury.
- Operating the microwave with no food inside for more than a minute or two may cause damage to the microwave oven and could start a fire. It increases the heat around the magnetron and can shorten the life of the microwave oven.
- Foods with unbroken outer "skin" such as potatoes, hot dogs, sausages, tomatoes, apples, chicken livers and other giblets, and egg yolks should be pierced to allow steam to escape during cooking.
- Avoid heating baby food in glass jars, even with the lid off. Make sure all infant food is thoroughly cooked. Stir food to distribute the heat evenly. Be careful to prevent scalding when warming formula or breast milk. The container may feel cooler than the milk really is. Always test the milk before feeding the baby.
- Spontaneous boiling—Under certain special circumstances, liquids may start to boil during or shortly after removal from the microwave oven. To prevent burns from splashing liquid, we recommend the following: before removing the container from the microwave oven, allow the container to stand in the microwave oven for 30 to 40 seconds after the microwave oven has shut off. Do not boil liquids in narrow-necked containers such as soft drink bottles, wine flasks and especially narrow-necked coffee cups. Even if the container is opened, excessive steam can build up and cause it to burst or overflow.
- Do not defrost frozen beverages in narrow-necked bottles (especially carbonated beverages). Even if the container is opened, pressure can build up. This can cause the container to burst, possibly resulting in injury.
- Hot foods and steam can cause burns. Be careful when opening any containers of hot food, including popcorn bags, cooking pouches and boxes. To prevent possible injury, direct steam away from hands and face.
- Do not overcook potatoes. They could dehydrate and catch fire, causing damage to your microwave oven.
- Cook meat and poultry thoroughly—meat to at least an INTERNAL temperature of 160°F and poultry to at least an INTERNAL temperature of 170°F. Cooking to these temperatures usually protects against foodborne illness.

# Microwave Oven Important Information (continued)

## ABOUT UTENSILS AND COVERINGS

It is not necessary to buy all new cookware. Many pieces already in your kitchen can be used successfully in your new microwave oven. Make sure the utensil does not touch the interior walls during cooking.

### Use these utensils for safe microwave cooking and reheating:

- glass ceramic (Pyroceram<sup>®</sup>), such as Corningware<sup>®</sup>
- heat-resistant glass (Pyrex<sup>®</sup>)
- microwave-safe plastics
- paper plates
- microwave-safe pottery, stoneware and porcelain
- browning dish (Do not exceed recommended preheating time. Follow manufacturer's directions.)

### These items can be used for short time reheating of foods that have little fat or sugar in them:

- wood, straw, wicker

## DO NOT USE

- metal pans and bakeware
- dishes with metallic trim
- non-heat-resistant glass
- non-microwave-safe plastics (margarine tubs)
- recycled paper products
- brown paper bags
- food storage bags
- metal twist-ties

Should you wish to check if a dish is safe for microwaving, place the empty dish in the microwave oven and microwave on HIGH for 30 seconds. A dish which becomes very hot should not be used.

## THE FOLLOWING COVERINGS ARE IDEAL:

- Paper towels are good for covering foods for reheating and absorbing fat while cooking bacon.
- Wax paper can be used for cooking and reheating.
- Plastic wrap that is specially marked for microwave use can be used for cooking and reheating. DO NOT allow plastic wrap to touch food. Vent so steam can escape.
- Lids that are microwave-safe are a good choice because heat is kept near the food to hasten cooking.
- Oven cooking bags are good for large meats or foods that need tenderizing. DO NOT use metal twist ties. Remember to slit bag so steam can escape.

## HOW TO USE ALUMINUM FOIL IN YOUR MICROWAVE OVEN:

- Small flat pieces of aluminum foil placed smoothly on the food can be used to shield areas that are either defrosting or cooking too quickly.
- Foil should not come closer than one inch to any surface of the microwave oven.

Should you have questions about utensils or coverings, check a good microwave cookbook or follow recipe suggestions.

**ACCESSORIES** There are many microwave accessories available for purchase. Evaluate carefully before you purchase so that they meet your needs. A microwave-safe

thermometer will assist you in determining correct doneness and assure you that foods have been cooked to safe temperatures. Sears is not responsible for any damage to the microwave oven when accessories are used.

## ABOUT CHILDREN AND THE MICROWAVE

Children below the age of 7 should use the microwave oven with a supervising person very near to them. Between the ages of 7 and 12, the supervising person should be in the same room.

At no time should anyone be allowed to lean or swing on the microwave oven door.

Children should be taught all safety precautions: use potholders, remove coverings carefully, pay special attention to packages that crisp food because they may be extra hot. Don't assume that because a child has mastered one cooking skill he/she can cook everything.

Children need to learn that the microwave oven is not a toy.

## ABOUT SAFETY

- Check foods to see that they are cooked to the United States Department of Agriculture's recommended temperatures.

---

160°F	For fresh pork, ground meat, boneless white poultry, fish, seafood, egg dishes and frozen prepared food.
165°F	For leftover, ready-to-reheat refrigerated, and deli and carry-out "fresh" food.
170°F	White meat of poultry.
175°F	Dark meat of poultry.

---

To test for doneness, insert a meat thermometer in a thick or dense area away from fat or bone. NEVER leave the thermometer in the food during cooking, unless it is approved for microwave oven use.

- ALWAYS use potholders to prevent burns when handling utensils that are in contact with hot food. Enough heat from the food can transfer through utensils to cause skin burns.
- Avoid steam burns by directing steam away from the face and hands. Slowly lift the farthest edge of a dish's covering and carefully open popcorn and oven cooking bags away from the face.
- Stay near the microwave oven while it's in use and check cooking progress frequently so that there is no chance of overcooking food.
- NEVER use the cavity for storing cookbooks or other items.
- Select, store and handle food carefully to preserve its high quality and minimize the spread of foodborne bacteria.
- Keep waveguide cover clean. Food residue can cause arcing and/or fires.
- Use care when removing items from the microwave oven so that the utensil, your clothes or accessories do not touch the safety door latches.



# Control Pad Features

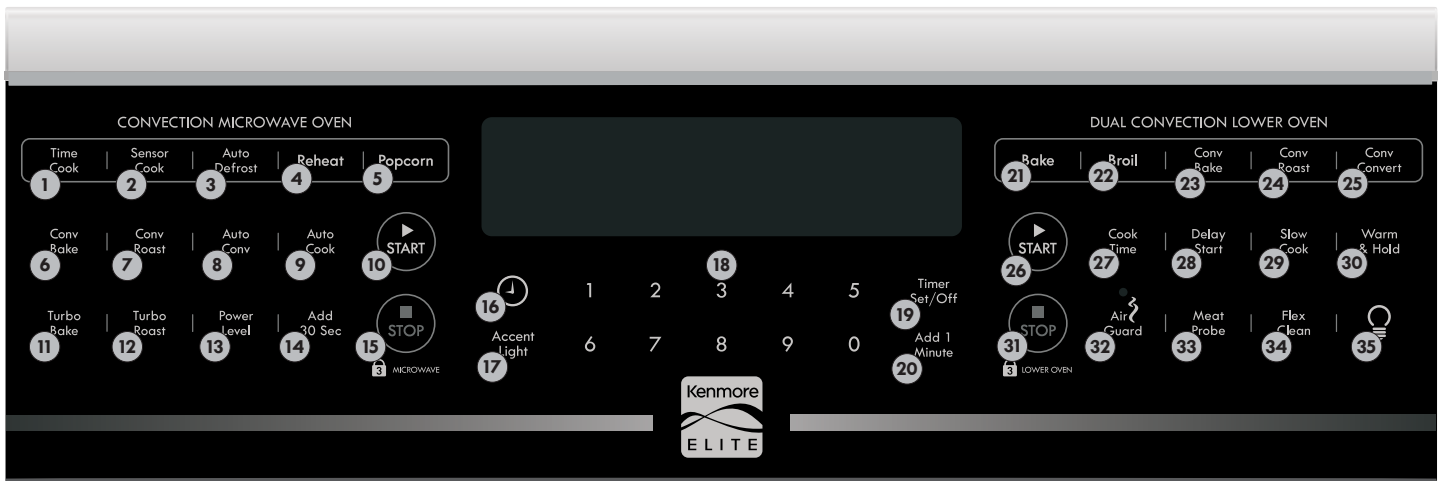

1. <b>Time Cook</b> - Use to enter cook time manually.	Page 13
2. <b>Sensor Cook</b> - Use to cook a wide variety of food by using the moisture sensor.	Page 15
3. <b>Auto Defrost</b> - Use to defrost a wide variety of food.	Page 16
4. <b>Reheat</b> - Use to select between the sensor reheat and the auto reheat modes.	Page 17
5. <b>Popcorn</b> - Use to automatically cook popcorn.	Page 14
6. <b>Conv Bake</b> - Use to select the convection bake mode for the convection microwave oven.	Page 18
7. <b>Conv Roast</b> - Use to select the convection roast mode for the convection microwave oven.	Page 18
8. <b>Auto Conv</b> - Use to automatically cook by convection (Bake, Roast, Broil) a wide variety of food.	Page 19
9. <b>Auto Cook</b> - Use to reheat pizzas and beverages, melt and soften food, or cook a variety of snacks.	Page 22
10. <b>START</b> - Use to start all microwave oven features.	-
11. <b>Turbo Bake</b> - Use to cook with both convection heat and microwave (at 10% power)	Page 23
12. <b>Turbo Roast</b> - Use to cook with both convection heat and microwave (at 30% power)	Page 23
13. <b>Power Level</b> - Use to set the microwave power level.	Page 13
14. <b>Add 30 Sec</b> - Use to extend cooking time by 30 seconds.	Page 23
15. <b>STOP</b> - Use to cancel any microwave oven function previously entered. Can also lockout the microwave functions.	Page 12
16. <b>Clock Set</b> - Use to set the time of day.	Page 12
17. <b>Accent Light</b> - Use to turn accent light ON and OFF.	Page 12
18. <b>0 thru 9 number</b> - Use to enter temperature and times. Also used to quick start the microwave oven.	Page 23
19. <b>Timer Set/Off</b> - Use to set or cancel timer. The minute timer does not start or stop cooking.	Page 12
20. <b>Add 1 Minute</b> - Use to add additional minutes to the timer feature.	Page 12
21. <b>Bake</b> - Use to enter the normal bake feature.	Page 24
22. <b>Broil</b> - Use to select variable broil feature.	Page 26
23. <b>Conv Bake</b> - Use to select the convection bake feature for the dual convection lower oven.	Page 27
24. <b>Conv Roast</b> - Use to select the convection roast feature for the dual convection lower oven.	Page 29
25. <b>Conv Convert</b> - Use to select the convection convert feature.	Page 28
26. <b>START</b> - Use to start all dual convection lower oven features.	-
27. <b>Cook Time</b> - Use to enter the length of the cook time desired.	Page 25
28. <b>Delay Start</b> - Use to set the desired start time for baking. May be used with Cook Time or Flex Clean.	Page 25
29. <b>Slow Cook</b> - Use to select the Slow Cook feature cycle.	Page 31
30. <b>Warm &amp; Hold</b> - Use to set the Warm & Hold function.	Page 31
31. <b>STOP</b> - Use to cancel any lower oven function previously entered. Can also lockout the lower functions and door.	Page 12
32. <b>Air Guard (some models)</b> - Use to clean the oven exhaust.	Page 12
33. <b>Meat Probe</b> - Use to enable the usage of the meat probe to cook without any guesswork.	Page 30
34. <b>Flex Clean</b> - Use to set a 2 to 4 hours self-clean cycle.	Page 36
35. <b>Oven Light</b> - Use to turn the lower oven light ON and OFF.	-

# Control Pad Settings & Microwave Menu Label

Minimum & maximum time settings		
Feature	Min. time	Max. time
Timer	1 min	11 hr 59 min
Clock 12 hr	1:00 hr	12 hr 59 min
Clock 24 hr	0:00 hr	23 hr 59 min
Cook time 12 hr	1 min	11 hr 59 min
Cook time 24 hr	1 min	11 hr 59 min
Delay Start 12 hr	1:00 hr	12 hr 59 min
Delay Start 24 hr	0:00 hr	23 hr 59 min
Flex Clean	2 hr	4 hr

Minimum & maximum lower oven control settings		
Feature	Min. temp	Max. temp
Bake	170°F / 76°C	550°F / 288°C
Broil	400°F / 204°C	550°F / 288°C
Conv Bake	170°F / 76°C	550°F / 288°C
Conv Roast	170°F / 76°C	550°F / 288°C
Slow Cook	Lo (225°F / 108°C)	Hi (275°F / 135°C)

Microwave oven menu label			
<b>Sensor Cook</b>		<b>Reheat</b>	
1 Ground Meat .5-2.0 lbs	2 Baked Potato 1-8 med.	3 Frozen Veggies .25-1.25 lbs	1 Sensor Reheat 4-36 oz
4 Soft Fresh Veggies - Broccoli .25-2.0 lbs - Brussels sprouts .25-2.0 lbs - Cabbage .25-2.0 lbs - Cauliflower (flowerets) .25-2.0 lbs	- Cauliflower (whole) 1 Medium - Spinach .25-1.0 lbs - Zucchini .25-2.0 lbs - Baked apples 2-4 medium	5 Hard Fresh Veggies - Carrots, sliced .25-2.0 lbs - Corn on cob 2-4 pieces - Green beans .25-2.0 lbs - Winter squash .25-2.0 lbs diced 1-2 halves	2 Auto Reheat 1 Rolls/Muffins 1-10 Fresh 2 Rolls/Muffins 1-10 Frozen 3 Pasta 1-6 cups
6 Frozen Entrees 6-17 oz	7 Chicken Breast .25-2.0 lbs	8 Rice .5-2.0 cups	<b>Auto Cook</b>
9 Bacon 1-6 slices	0 Fish, Seafood .25-2.0 lbs		1 Pizza 1-6 slices 2 Beverage .5-2.0 cups 3 Melt, Soften 1 Ice Cream 1 pint, .5 gal 2 Cream Cheese 3, 8 oz 3 Butter 2 tbs, .5 cup 4 Chocolate 1 cup, 1 square
<b>Auto Conv</b>			
<b>Auto Bake</b>	<b>Auto Roast</b>	<b>Auto Broil</b>	
1 Bundt Cake 1 2 Cookies 1 or 2 pans 3 Muffins 1 or 2 pans 4 French Fries 3-24 oz	1 Chicken 2.5-7.5 lbs 2 Turkey 6.5-16 lbs 3 Turkey Breast 3-6 lbs 4 Pork 2-3.5 lbs	1 Hamburgers 1-8 piece 2 Chicken Pieces .5-3.5 lbs 3 Steaks .5-2 lbs 4 Fish Steaks .5-2 lbs	
<b>Popcorn</b>	<b>Auto Defrost</b>		
USE POPCORN TRAY 1 Snack 1.5-1.75 oz 2 Regular 3-3.5 oz	1 Ground Meat .5-3.0 lbs 2 Steak/Chops/Fish .5-4.0 lbs 3 Chicken Pieces .5-3 lbs	4 Roast 2-4 lbs 5 Casserole 2-6 cups 6 Soup 1-6 cups	
		4 Snacks 1 Microwave Pizza 6-8 oz 2 Hand Held Snacks 3-4 oz 3 Hand Held Snacks 5-6 oz 4 Chicken Nuggets .3-1 lbs 5 Frozen Kid's Meal 6-8 oz 6 Hot Dogs 1-6	

# Oven Vent and Racks



**⚠ CAUTION** This appliance is equipped with a blower which runs in baking and self-cleaning mode to keep all internal components at a cool temperature. The blower may keep running even if the oven has been turned off, until the components have cooled down.

## OVEN VENT LOCATION

Each oven is vented **at its upper front frame**. When the oven is on, warm air is released through the vent. This venting is necessary for proper air circulation in the oven and good baking results.

## ARRANGING LOWER OVEN RACKS

**ALWAYS ARRANGE OVEN RACKS WHEN THE OVEN IS COOL (PRIOR TO OPERATING THE OVEN).** Always use oven mitts when using the oven.

**To remove an oven rack,** pull the rack forward until it stops. Lift up front of rack and slide out.

**To replace an oven rack,** fit the rack onto the guides on the oven walls. Tilt the front of the rack upward and slide the rack back into place.

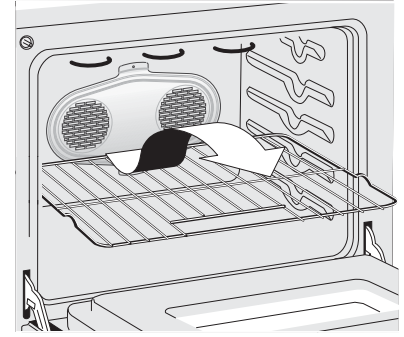

Model with dual fan shown only

## TYPES OF OVEN RACKS

**⚠ CAUTION** Always use pot holders or oven mitts when adjusting the oven racks. Wait until the oven has completely cooled if possible. Oven racks may **HOT** and cause burns.

Your appliance may be equipped with one or more of the oven rack types shown; **Flat Handle Oven Rack** and **Offset Oven Rack**. To maximize cooking space the offset rack can be used in the lowest rack position to roast large cuts of meat and poultry.

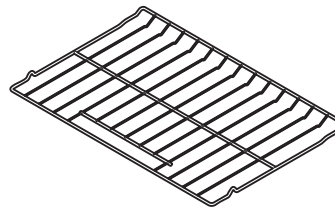

Flat Handle Oven Rack

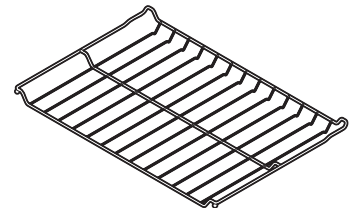

Offset Oven Rack

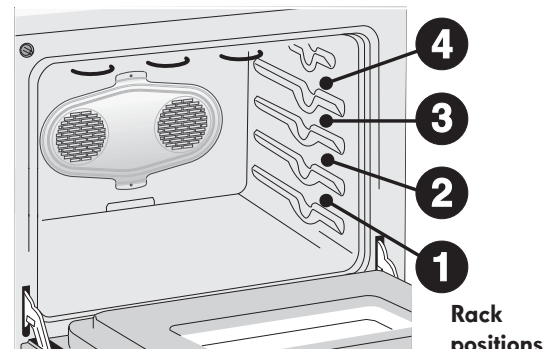

Model with dual fan shown only

RECOMMENDED RACK POSITIONS FOR BROILING, BAKING & ROASTING FOR LOWER OVEN		
Food	Rack Position	
Broiling meats, chicken or fish	3 or 4	
Cookies, cakes, pies, biscuits & muffins	Using 1 rack	2 or 3
	Using multiple racks	2 and 4
Frozen pies, angel food cake, yeast, bread, casseroles, small cuts of meat or poultry	1 or 2	
Turkey, roast or ham	1 (Offset Rack)	

## AIR CIRCULATION IN THE LOWER OVEN

If using 1 rack, place in center of oven. If using multiple racks, stagger cookware as shown.

For best air circulation and baking results allow 2-4" (5-10 cm) around the cookware for proper air circulation and be sure pans and cookware do not touch each other, the oven door, sides or back of the oven cavity. The hot air must circulate around the pans and cookware in the oven for even heat to reach around the food.

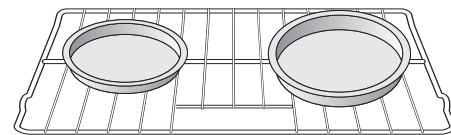

1 Oven Rack (27" & 30" models)

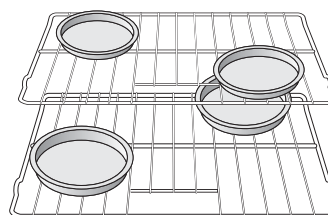

Multiple Oven Racks (27" Models)

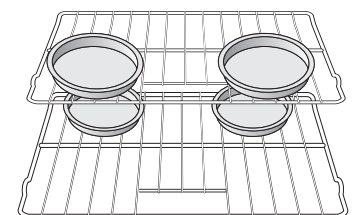

Multiple Oven Racks (30" Models)

## Getting Started

### SETTING CLOCK AT POWER UP

You will be prompted to enter the time of day in the event of a power failure or when you first provide electric power to your appliance.

- When your appliance is first powered up, 12:00 will flash in the display.
- Enter the time of day using the numeric key pads and press **START** to set.

If an invalid time of day is entered, the control will triple beep. Re-enter a valid time of day and press **START**. If **STOP** is pressed your clock will start with the time set for **12:00**.

Select the **CLOCK**  key to modify the time of day during other situations such as day light savings.

### TIMER

The timer provided with the oven control serves as an extra reminder in the kitchen. When the timer reaches less than 1 minute the display will start to count down in seconds. When the time runs out the active timer will beep, and "End" will be displayed.

The following time settings apply to the timers:

- Min. time: 1 minute
- Max. time: 11 hours 59 minutes

See example below to set the timer for 5 minutes:

1. Press **TIMER SET/OFF**
2. Enter **5** minutes
3. Press **START**

To cancel or end the timer, press the **TIMER SET/OFF** key again.

**NOTE:** The timer(s) will not affect the cooking process.

### TO SET ADD 1 MINUTE FEATURE

The ADD 1 MINUTE pad is used to set the Add 1 Minute feature. When the pad is pressed, 1 minute is added to the Timer feature if this feature is already active. If the Timer feature is not active and the pad is pressed, the Timer feature will become active and will begin counting down from 1 minute. For further information on how to set the Timer feature see Timer instructions above.

### USING THE AIRGUARD FEATURE (SOME MODELS)

Your appliance is equipped with a catalytic oven exhaust cleaner that may be turned on during any cooking process. This feature helps remove smoke and eliminates 85% of the odors generated when using your oven. **DO NOT** use AirGuard when baking delicate bakery items.

If you wish to clean the oven exhaust once cooking has started, press **AIRGUARD**.

**NOTE:** The AirGuard indicator light will glow anytime AirGuard is active. AirGuard will automatically turn on and cannot be manually turned off during the Self-Cleaning cycle.

### PREHEAT TEMPERATURE DISPLAY

Once a cooking feature has been started in one of the ovens, the control will display the actual oven temperature while preheating. Once the oven reaches the oven set temperature only the oven set temperature will display.

The preheat temperature display is available with the following cooking modes:

- Bake in lower oven
- Conv Bake in both ovens

### CONTROL LOCK

Two control locks are available on this unit. The lower oven control lock will lock the oven controls and the lower oven door. The microwave control lock will only lock the microwave controls.

See example below to lock the lower oven.

To lock, press and hold **STOP** for 3 seconds.

To unlock, press and hold **STOP** for 3 seconds.

**DOOR LOCKED** will flash in the display until the door has finished locking. Once the door has been locked the door lock indicator will turn on. **DOOR LOCKED** will then display in the upper oven cavity only.

Do not attempt to open the oven door while the door lock indicator is flashing.

### ACCENT LIGHT

Your appliance includes a decorative Accent light centered horizontally across the touch-sensitive control panel. The Accent light comes with a theatre style intensity feature that slowly increases brightness at turn on and slowly fades when turning off.

When the Accent light is off, the light is in automatic mode. This means the Accent light will turn on automatically when an oven or Timer has been activated. The Accent light will turn off automatically when these functions are no longer active.

When the Accent light is OFF, it may be manually turned ON by pressing the Accent Light keypad once. When the Accent light has been manually turned on, it will remain on until manually turned off by pressing the Accent Light keypad again. The brightness of the Accent light may also be adjusted.

See example below to adjust Accent light brightness:

1. Press and hold the **ACCENT LIGHT** keypad until an acceptance tone sounds (about 6 seconds).
2. Using the numeric keypads, enter any digit from **0** to **100** to change the brightness level. Entering **0** will effectively turn the Accent light OFF until the brightness level is adjusted to a higher level.
3. Press **START** to save the desired brightness setting.

# Microwave Manual Operation

## TIME COOKING

Your Microwave Oven can be programmed up to 99 minutes 59 seconds (99.59). Always enter the seconds after the minutes, even if they are both zeros.

- Suppose you want to cook for 5 minutes at 100%.
  1. Press **TIME COOK**
  2. Enter cooking time by pressing **5 0 0** on the numeric pads.
  3. Press **START**

## TO SET POWER LEVEL

Using lower power levels increases the cooking time which is recommended for foods such as cheese, milk and long slow cooking of meats. Consult cookbook or recipes for specific recommendations.

- Suppose you want to cook for 5 minutes at 70%.
  1. Enter cooking time by pressing **5 0 0** on the numeric pads.
  2. Press **POWER LEVEL**
  3. Enter power level by pressing **7** on the numeric pads.
  4. Press **START**

Power level	Common words for power levels
100	High
90	
80	
70	Medium High
60	
50	Medium
40	
30	Med Low / Defrost
20	
10	Low

## MANUAL DEFROST

If the food that you wish to defrost is not listed on the Defrost chart or is above or below the limits in the "Amount" column on the Defrost chart, you need to defrost manually.

You can defrost any frozen food, either raw or previously cooked, by using Power level 30. Follow the exact procedure found under Time cooking. Estimate defrosting time and lower your power level to 30%.

For either raw or previously cooked frozen food the rule of thumb is approximately 5 minutes per pound. For example, defrost 5 minutes for 1 pound of frozen spaghetti sauce.

Always stop the oven periodically to remove or separate the portions that are defrosted. If food is not defrosted at the end of the estimated defrosting time, program the oven in 1 minute increments on power level 30 until totally defrosted.

When using plastic containers from the freezer, defrost only long enough to remove from the plastic in order to place in a microwave-safe dish.

- Suppose you want to defrost for 5 minutes.
  1. Enter cooking time by pressing **5 0 0** on the numeric pads.
  2. Press **POWER LEVEL**
  3. Enter power level by pressing **3** on the numeric pads.
  4. Press **START**

# Microwave Operating Instructions

## SENSOR MODE

The sensor is a semi-conductor device that detects the vapor (moisture and humidity) emitted from the food as it heats. The sensor adjusts the cooking times and power level for various foods and quantities. Popcorn, Sensor Cook and Sensor Reheat are part of the Sensor Mode.

### Using Sensor Mode:

1. After oven is plugged in, wait 2 minutes before using Sensor Mode.
2. Be sure the exterior of the cooking container and the interior of the oven are dry. Wipe off any moisture with a dry cloth or paper towel.
3. The oven works with foods at normal storage temperature. For example, popcorn would be at room temperature.
4. Any Sensor Mode selection can be programmed with more or less time adjustment.
5. More or less food than the quantity listed in the chart should be cooked following the guidelines in any microwave cookbook.
6. During the first part of any sensor cooking or reheating, SENSING will appear on the display. Do not open the oven door during this part of the cycle. The measurement of vapor will be interrupted. If this occurs, an error message will appear. To continue cooking, press the **STOP** pad and cook manually.  

When the sensor detects the vapor emitted from the food, remainder of cooking time will appear. Door may be opened when remaining cooking time appears on the display. At this time, you may stir or season food, as desired.
7. Except for popcorn, if the sensor does not detect vapor properly when cooking other foods, ERROR will be displayed.
8. Check food for temperature after cooking. If additional time is needed, continue to cook manually.

## COVERING FOODS

Some foods cook better when covered. Use the cover recommended in the food charts.

1. Casserole lid.
2. Plastic wrap: Use plastic wrap recommended for microwave cooking. Cover dish loosely; allow approximately 1/2 inch to remain uncovered to allow steam to escape. Plastic wrap should not touch food.
3. Wax paper: Cover dish completely; fold excess wrap under dish to secure. If dish is wider than paper, overlap two pieces at least one inch to cover.

Be careful when removing any covering to allow steam to escape away from you.

## POPCORN

You can cook popcorn by touching a quick pad (**popcorn**). You don't need to calculate cooking time or power level.

### WARNING

Do not place microwave popcorn directly on the metal turntable as metal on metal may produce sparking. Always use the popcorn/bacon tray provided with the unit to cook popcorn.

- Suppose you want to pop a 3.5 oz. bag of popcorn.

1. Press **popcorn**.
2. Press **2** for regular size.
3. Press **START**

Amount	
1. <b>Snack</b>	1.5-1.75 oz bag
2. <b>Regular</b>	3.0 - 3.5 oz bag

### Procedure

Use only popcorn packaged for the microwave. Try several brands to decide which you like. After popping cycle do not try to reheat unpopped kernels. Use the popcorn/bacon tray provided with your unit to cook popcorn quickly and efficiently. This sensor works well with most brands of microwave popcorn. You may wish to try several and choose your favorite. Pop only one bag at a time. Unfold the bag and place in oven according to directions.

## NOTES

The final result will vary according to the food condition (e.g. initial temperature, shape, quality). Check food for temperature after heating. If additional time is needed, continue to heat manually.

This mode can be programmed with More or less time adjustment by touching the **power level** pad once or twice before touching **START** pad.

# Microwave Operating Instructions (continued)

## SENSOR COOK

You can cook many foods by touching the **sensor cook** pad and the food number. You don't need to calculate cooking time or power level.

- Suppose you want to cook a baked potato.

1. Press **SENSOR COOK**
2. Press **2** for baked potato.
3. Press **START**

## NOTES

1. The final result will vary according to the food condition (e.g. initial temperature, shape, quality). Check food for temperature after heating. If additional time is needed, continue to heat manually.
2. Stay near the oven while it's in use and check cooking progress frequently so that there is no chance of overcooking food.
3. This mode can be programmed with more or less time adjustment by touching the **power level** pad once or twice before touching **START** pad.

Food	Amount	Procedure															
<b>1. Ground Meat</b>	0.25 - 2.00 lb	Use this setting to cook ground beef or turkey as patties or in a casserole to be added to other ingredients. Place patties on a microwave-safe rack and cover with wax paper. Place ground meat in a casserole and cover with wax paper or plastic wrap. When oven stops, turn patties over or stir meat in casserole to break up large pieces. After cooking, let stand, covered, for 2 to 3 minutes.															
<b>2. Baked Potato</b>	1 - 8 med.	Pierce with fork in several places. Place on paper towel on turntable. After cooking, remove from oven and let stand wrapped in foil for 5 to 10 minutes.															
<b>3. Frozen Veggies</b>	0.25 - 1.25 lb	Add no water. Cover with lid or plastic wrap. After cooking, stir and let stand, covered, for 3 minutes.															
<b>4. Fresh Veggies, Soft</b>																	
Broccoli	0.25 - 2.0 lb	Wash and place in casserole. Add no water if vegetables have just been washed. Cover with lid for tender vegetables. Use plastic wrap for tender-crisp vegetables. After cooking, stir, if possible. Let stand, covered, for 2 to 5 minutes.															
Brussels sprouts	0.25 - 2.0 lb																
Cabbage	0.25 - 2.0 lb																
Cauliflower (flowerets)	0.25 - 2.0 lb																
Cauliflower (whole)	1 medium																
Spinach	0.25 - 1.0 lb																
Zucchini	0.25 - 2.0 lb																
Baked apples	2 - 4 medium																
<b>5. Fresh Veggies, Hard</b>																	
Carrots, sliced	0.25 - 2.0 lb	Place in casserole. Add 1-4 tbsp. water. Cover with lid for tender vegetables. Use plastic wrap cover for tender-crisp vegetables. After cooking, stir, if possible. Let stand, covered, for 2 to 5 minutes.															
Corn on cob	2 - 4 pcs.																
Green beans	0.25 - 2.0 lb																
Winter squash																	
- diced	0.25 - 2.0 lb																
- halves	1 - 2																
<b>6. Frozen Entrees</b>	6 - 17 oz	Use this pad for frozen, convenience foods. It will give satisfactory results for most brands. You may wish to try several and choose your favorite. Remove package from outer wrapping and follow package directions for covering. After cooking, let stand, covered for 1 to 3 minutes.															
<b>7. Chicken Breast</b>	0.25 - 2.00 lb	Cover with vented plastic wrap. When oven stops, turn over. Shield with small, flat pieces of aluminum foil any areas that are cooking too rapidly. After cooking, let stand, covered 3 to 5 minutes. Chicken should be 160°F.															
<b>8. Rice</b>	0.5 - 2.0 cups	Place rice into a deep casserole dish and add double quantity of water. Cover with lid or plastic wrap. After cooking, stir, cover and let stand 3 to 5 minutes or until all liquid has been absorbed.															
		<table border="1"> <thead> <tr> <th>Rice</th> <th>Water</th> <th>Size of casserole dish</th> </tr> </thead> <tbody> <tr> <td>.5 cup</td> <td>1 cup</td> <td>1.5 quart</td> </tr> <tr> <td>1 cup</td> <td>2 cups</td> <td>2 quart</td> </tr> <tr> <td>1.5 cups</td> <td>3 cups</td> <td>2.5 or 3 quart</td> </tr> <tr> <td>2 cups</td> <td>4 cups</td> <td>3 quart or larger</td> </tr> </tbody> </table>	Rice	Water	Size of casserole dish	.5 cup	1 cup	1.5 quart	1 cup	2 cups	2 quart	1.5 cups	3 cups	2.5 or 3 quart	2 cups	4 cups	3 quart or larger
Rice	Water	Size of casserole dish															
.5 cup	1 cup	1.5 quart															
1 cup	2 cups	2 quart															
1.5 cups	3 cups	2.5 or 3 quart															
2 cups	4 cups	3 quart or larger															
<b>9. Bacon</b>	1 - 6 slices	Prepare on the bacon tray. Lay up to six uncooked bacon strips across the tray. When cooked, remove from the tray and place on paper towel to absorb any bit of fat there is. Allow it to sit for about 1 minute to cool. The bacon will be crispy and delicious.															
<b>0. Fish / Seafood</b>	0.25 - 2.0 lb	Arrange in ring around shallow glass dish (roll fillet with edges underneath). Cover with plastic wrap. After cooking, let stand, covered, 3 minutes.															

## Microwave Operating Instructions (continued)

### AUTO DEFROST

Auto Defrost automatically defrosts all the foods found in the Auto Defrost chart below.

- Suppose you want to defrost a 2.0 pound steak.
  1. Press **AUTO DEFROST** pad.
  2. Press number 2 for steaks.
  3. Press **START** pad.
  4. Enter weight by touching the number pads 2 and 0.  
Ex: 2.0 lb steak.
  5. Press **START** pad. The oven will stop so the food can be checked.
  6. After the 1st stage, open the door. Turn steak over and shield any warm portions. Close the door. Press **START** pad.

After defrost cycle ends, let stand, covered.

### NOTES

1. For best results, it is recommended to place food on the popcorn/bacon tray.
2. To defrost other food or foods above or below the weights allowed on the Defrost chart, use time and 30% power. See Manual defrost.
3. Auto Defrost can be programmed with more or less time adjustment by touch the **power level** pad once or twice before touching **START** pad.
4. Should you attempt to enter more or less than the allowed amount, an error beep will sound.
5. Check foods when oven signals. After final stage, small sections may still be icy. Let stand to continue thawing. Do not defrost until all ice crystals are thawed.
6. Shielding prevents cooking from occurring before the center of the food is defrosted. Use small smooth strips of aluminum foil to cover edges and thinner sections of the food.

Food	Amount	Default	Procedure
1. <b>Ground Meat</b>	0.5 - 3.0 lb	0.5 lb	Remove any thawed pieces after each stage. Let stand, covered, for 5 to 10 minutes.
2. <b>Steaks/Chops/ Fish</b>	0.5 - 4.0 lb	0.5 lb	After each stage, rearrange and if there are warm or thawed portions, shield with small flat pieces of aluminum foil. Remove any meat or fish that is almost defrosted. Let stand, covered, for 10 to 20 minutes.
3. <b>Chicken Pieces</b>	0.5 - 3.0 lb	0.5 lb	After each stage, rearrange pieces or remove portions should they become warm or thawed. Let stand, covered, for 10 to 20 minutes.
4. <b>Roast</b>	2.0 - 4.0 lb	2.0 lb	Start defrosting with fat side down. After each stage, turn roast over and shield the warm portions with aluminum foil. Let stand, covered, for 30 to 60 minutes.
5. <b>Casserole</b>	2 - 6 cups	2 cups	After audible signal, stir if possible. At end, stir well and let stand, covered, for 5 to 10 minutes.
6. <b>Soup</b>	1 - 6 cups	1 cup	After audible signal, stir if possible. At end, stir well and let stand, covered, for 5 to 10 minutes.



# Microwave Operating Instructions (continued)

## REHEAT

The reheat pad includes two different ways of reheating your favorite meals.

The sensor reheat detects the vapor (moisture and humidity) emitted from the food as it heats. The sensor adjusts the reheat times and power level for various foods and quantities. Refer to the sensor modes section for more informations.

The auto reheat settings automatically computes the correct warming and heating time and microwave power level for foods shown in the chart below.

## NOTES

1. To reheat different foods or foods above or below the quantity allowed, use manual operation.
  2. This mode can be programmed with more or less time adjustment by touching the **power level** pad once or twice before touching **START** pad.
- Suppose you want to heat 2 fresh rolls or muffins.
    1. Press **REHEAT**.
    2. Press number **2** for auto reheat.
    3. Press **START** to confirm.
    4. Press number **1** for fresh rolls or muffins.
    5. Press **START** to confirm.
    6. Press number **2** to select quantity.
    7. Press **START**.

### 1. Sensor Reheat

Amount	Procedure
4 - 36 oz	Place in dish or casserole slightly larger than amount to be reheated. Flatten, if possible. Cover with lid, plastic wrap or wax paper. Use covers such as plastic wrap or lids with larger quantities of more dense foods such as stews. After reheating, stir well, if possible. Re-cover and allow to stand 2 to 3 minutes. Foods should be very hot. If not, continue to heat with variable power and time.

### 2. Auto Reheat

Food	Amount	Default	Procedure
1. <b>Fresh Rolls/ Muffins</b>	1 - 10	1	Use this pad to warm rolls, muffins, biscuits, bagels etc. Large items should be considered as 2 or 3 regular size. Arrange on plate; cover with paper towel. For refrigerated rolls or muffins, it may be necessary to double the entered amount to ensure the proper serving temperature. For example, enter quantity of 2 for 1 refrigerated muffin. Touch desired number to select quantity and touch <b>START</b> .
2. <b>Frozen Rolls/ Muffins</b>	1 - 10	1	Use this pad to warm frozen rolls, muffins, biscuits, bagels, etc. Large items should be considered as 2 or 3 regular size. Arrange on plate, cover with paper towel. Touch desired number to select quantity and touch <b>START</b> .
3. <b>Pasta</b>	1 - 6 cups	1 cup	Use this pad to reheat refrigerated canned or homemade pasta with sauce. For room temperature pastas, use Less option. Pasta without sauce double the quantity per setting. For example, measure 2 cups of cooked noodles and program for 1 cup. Cover with lid or plastic wrap. Enter the desired number of cups and touch <b>START</b> . After cooking, let stand, covered, 2 to 3 minutes.

## Microwave Operating Instructions (continued)

### CONVECTION COOKING

During convection heating, hot air is circulated throughout the oven cavity to brown and crisp foods quickly and evenly.

This section gives you specific convection cooking instructions and procedures.

The oven should not be used without the turntable in place, and it should never be restricted so that it cannot rotate. You may remove the turntable when preheating the oven and when preparing food to be cooked directly on the turntable.

#### CAUTION

The oven cabinet, cavity, door, turntable, turntable support, racks and dishes will become hot. To PREVENT BURNS, use thick oven gloves when removing the food or turntable from the oven.

### TO SET TEMPERATURE LEVEL IN CONVECTION COOKING

There are ten preset temperature levels.

Using lower temperature levels increases the cooking time which is recommended for foods such as cheese, milk and long slow cooking of meats. Consult cookbook or recipes for specific recommendations.

Temperature numeric pad	Preset temperature level
1	100 °F
2	150 °F
3	275 °F
4	300 °F
5	325 °F
6	350 °F
7	375 °F
8	400 °F
9	425 °F
0	450 °F

#### IMPORTANT - PREHEAT

To set the convection mode with a preheat feature, you must press the convection pad a second time.

When the oven has reached the desired temperature, it will prompt you to place food in the oven. Place food in the oven and press **START** to begin cooking.

### CONVECTION BAKE

- Suppose you want to preheat and cook at 350°F for 20 minutes.

1. Press **CONV. BAKE**.
2. Press **CONV. BAKE** again to preheat.
3. Select temperature (350°F) by pressing number pad **6**.
4. Press **START**.
5. Enter cooking time by pressing the number pads **2 0 0 0**.
6. Press **START**.

### CONVECTION ROAST

Use convection roast setting for steaks, chops, chicken pieces and many other foods. Only actual cooking time is entered; the temperature is set at 450°F and cannot be changed.

- Suppose you want to preheat and broil a steak for 15 minutes.
1. Press **CONV. ROAST**.
  2. Press **CONV. ROAST** again to preheat.
  3. Press **START** to confirm preheat.
  4. Enter cooking time by touching the number pads **1 5 0 0**.
  5. Press **START**.

When the oven has reached the desired temperature, it will prompt you to place food in the oven. Place food in the oven and press **START** to begin cooking.

### NOTES

The oven will reach the roast temperature in 7 to 10 minutes depending on temperature of room and available power.

Although time is usually set for the maximum roasting time, always check food at the minimum time recommended in the chart of cookbook. This will eliminate the need to completely reprogram the oven if additional cooking time is needed. Simply close the oven door and touch **START** to continue.

# Microwave Operating Instructions (continued)

## AUTO CONV

### 1. BAKE

**Bake** automatically bakes cakes, brownies, muffins and french fries.

- Suppose you want to bake a bundt cake.

1. Press **AUTO CONV**.
2. Press **1** for **BAKE**.
3. Press **START**.
4. Select desired setting.  
Ex: for bundt cake, press number **1**.
5. Press **START**.

### NOTES

This mode can be programmed with more or less time adjustment by touching the **power level** pad once or twice before touching **START** pad.

#### CAUTION

The oven cabinet, cavity, door, turntable, turntable support, racks and dishes will become hot. To PREVENT BURNS, use thick oven gloves when removing the food or turntable from the oven.

Setting/Food	Amount	Default	Rack	Procedure
<b>1. Bundt cake</b>	1 cake	N/A	No rack	Ideal for packaged cake mix or your own recipe. Prepare according to package or recipe directions and place in a greased and floured bundt pan. Place pan in oven. Cool before frosting and serving.
<b>2. Cookies</b>	1 or 2 pizza pan	N/A	1 pizza pan No rack  2 pizza pans High	Ideal for refrigerated cookie dough. Prepare according to package or recipe directions and place on a greased and floured 12-inch pizza pan. Cookies should be approximately 1/3-inch thick and 2-inches in diameter for best results. When the oven has reached the cooking temperature, it will prompt you to place food in the oven. Place food in the oven and press <b>START</b> to begin cooking. Cool before serving.
<b>3. Muffins</b>	6 - 12 cups  1 or 2 muffin pans	N/A	1 pan No rack  2 pans High	Ideal for packaged muffin mix or your own recipe for 6-12 medium size muffins. Prepare according to package or recipe directions and place in muffin pan. When the oven has reached the cooking temperature, it will prompt you to place food in the oven. Place food in the oven and press <b>START</b> to begin cooking.
<b>4. French fries</b>	3 - 24 oz  1 or 2 pizza pans  For more than 12 oz use 2 pans	3 oz	1 pizza pan No rack  2 pizza pans High	Use frozen prepared french fries.  No preheat is required for the french fries baking procedure. Place french fries on pizza pan.  For shoestring potatoes, touch <b>power level</b> pad twice to enter less time before touching Start pad.

# Microwave Operating Instructions (continued)

## AUTO CONV

### 2. ROAST

**Roast** automatically roasts chicken, turkey, turkey breast or pork.

- Suppose you want to roast a 2.5 pound chicken.

1. Press **AUTO CONV**.
2. Press **2** for **ROAST**.
3. Press **START**.
4. Select desired setting.  
Ex: for chicken, press number **1**.
5. Press **START**.
6. Enter weight by touching the number pads **2 5**.  
Ex: 2.5 lb.
7. Press **START**.

After Roast cycle ends, a long tone will sound. Follow the indicated message.

### NOTES

This mode can be programmed with more or less time adjustment by touching the **power level** pad once or twice before touching **START** pad.

Should you attempt to enter more or less than the allowed amount, an error beep will sound.

### CAUTION

The oven cabinet, cavity, door, turntable, turntable support, racks and dishes will become hot. To PREVENT BURNS, use thick oven gloves when removing the food or turntable from the oven.

Setting/Food	Amount	Default	Rack	Procedure
<b>1. Chicken</b>	2.5 - 7.5 lb	2.5 lb	Low	After the cycle ends, cover with foil and let stand for 5-10 minutes.
<b>2. Turkey</b>	6.5 - 16 lb	6.5 lb	Low	Season, as desired. Place on low rack. After the cycle ends, cover with foil and let stand 10 minutes. Internal temperature of white meat should be 170°F and of dark meat, 180°F.
<b>3. Turkey breast</b>	3 - 6 lb	3 lb	Low	Season, as desired. Place on low rack. After the cycle ends, cover with foil and let stand 10 minutes. Internal temperature of white meat should be 170°F.
<b>4. Pork</b>	2 - 3.5 lb	2 lb	Low	Boneless pork loin is recommended because it cooks evenly. Place on a low rack. After cooking, remove from oven, cover with foil and allow to stand 5-10 minutes. Internal temperature should be 160°F.

# Microwave Operating Instructions (continued)

## AUTO CONV

### 3. BROIL

**Broil** automatically broils hamburgers, chicken pieces, steaks and fish steaks.

- Suppose you want to broil 2 hamburgers.

1. Press **AUTO CONV**.
2. Press **3** for **BROIL**.
3. Press **START**.
4. Select desired setting.  
Ex: for hamburgers, press number **1**.
5. Press **START**.
6. Press number pad **2** to enter quantity.

Follow information in display for cooking information. For well done or rare burgers, touch **POWER LEVEL** pad to select More for well done or Less for rare. See More/Less Time Adjustment.

7. Press **START**.

After broil preheat cycle ends, the oven will stop and directions will be displayed. Follow the indicated message. Open the door and place hamburgers into oven. Close the door.

8. Press **START**.

### NOTES

This mode can be programmed with more or less time adjustment by touching the **power level** pad once or twice before touching **START** pad.

Should you attempt to enter more or less than the allowed amount, an error beep will sound.

### CAUTION

The oven cabinet, cavity, door, turntable, turntable support, racks and dishes will become hot. To PREVENT BURNS, use thick oven gloves when removing the food or turntable from the oven.

Setting/Food	Amount	Default	Rack	Procedure
1. <b>Hamburgers</b>	1 - 8 pieces 0.25 lb each	1 piece	Low	Use this setting to broil hamburger patties. Place on low rack.
2. <b>Chicken pieces</b>	0.5 - 3.5 lb	0.5 lb	Low	Arrange pieces on low rack. After cooking, let stand, 3-5 minutes. Dark meat should be 180°F, and white meat should be 170°F.
3. <b>Steaks</b>	0.5 - 2 lb	0.5 lb	Low	Use this setting to broil steaks from 3/4" to 1" thick. Individual boneless steaks broil evenly. Place steak on low rack. For well done, touch POWER LEVEL once; for rare, touch POWER LEVEL twice.
4. <b>Fish steaks</b>	0.5 - 2 lb	0.5 lb	Low	Use this setting to broil fish steak which is 3/4" to 1" thick. Place on low rack.

# Microwave Operating Instructions (continued)

## AUTO COOK

Your oven has convenient pads to assist with meal preparation. The Auto Cook settings will automatically compute the correct cooking time and microwave power level for foods shown in the following charts.

- Suppose you want to melt 1/2 cup of butter.

1. Press **AUTO COOK**.
2. Press **3** for Melt, Soften.
3. Press **START** to confirm.
4. Press **3** for Butter.
5. Press **START** to confirm.
6. Press **2** for 1/2 cup.
7. Press **START**.

## NOTES

All Auto Cook settings can be programmed with more or less time adjustment by touching the **power level** pad once or twice before touching **START** pad.

Should you attempt to enter more or less than the allowed amount, an error beep will sound.

More or less than the quantity listed in the chart should be cooked following the guidelines in any microwave cookbook.

The final cooking result will vary according to the food condition (e.g. initial temperature, shape, quality). Check food for temperature after cooking. If additional time is needed, continue to cook manually.

Food	Amount	Default	Procedure
<b>1. Pizza</b>	1 - 6 slices (6 - 8 oz)	1 slice	Use this setting to reheat refrigerated leftover pizza, 1 slice is approximately 1/8th of a 12-inch pizza or 1/12th of a 16-inch pizza. If possible, place on paper towel on a microwave-safe rack.
<b>2. Beverage</b>	0.5 - 2.0 cups	1 cup	This setting is good for restoring a cool beverage to a better drinking temperature. Stir liquid briskly before and after heating to avoid "eruption". The <b>beverage</b> setting must be entered in 0.1 cup measurements.
<b>3. Melt, Soften</b>			DO NOT COVER.
1- Ice Cream	1 pint 1/2 gallon	1 pint	Touch number 1 for 1 pint. Touch number 2 for 1/2 gallon.
2- Cream Cheese	3 oz 8 oz	3 oz	Touch number 1 for 3 oz. Touch number 2 for 8 oz.
3- Butter	2 tbsp 1/2 cup	2 tbsp	Use a Pyrex measuring cup. Cover with plastic wrap. Touch number 1 for 2 tbsp. Touch number 2 for 1/2 cup.
4- Chocolate	1 cup chips 1 square	1 square	Touch number 1 for 1 cup of chips. Touch number 2 for 1 square.
<b>4. Snacks</b>			
1- Microwave Pizza	1 (6 - 8 oz)	N/A	Use for frozen microwave pizza. Remove from package and unwrap. Follow package directions for use of package and/or silver crisping disc.
2- Hand-held Snacks	3 - 4 oz	N/A	Use for frozen french fries, cheese sticks, appetizers etc. Remove from outer package. Follow package directions for how to wrap or cover. Be careful when removing from the oven as snack may be very hot.
3- Hand-held Snacks	5 - 6 oz	N/A	Use for frozen french fries, cheese sticks, appetizers etc. Remove from outer package. Follow package directions for how to wrap or cover. Be careful when removing from the oven as snack may be very hot.
4- Chicken Nuggets	0.3 - 1.0 lb	0.4 lb	Place frozen chicken nuggets on a flat plate allowing space between each, cover food with paper towel. Enter weight and touch <b>START</b> . After cooking, open door, rearrange, close door and touch <b>START</b> . Let stand, covered, for 1 to 3 minutes.
5- Frozen Kid's Meal	6 - 8 oz	N/A	Use this pad for frozen, convenience foods. It will give satisfactory results for most brands. You may wish to try several and choose your favorite. Remove package from outer wrapping and follow package directions for covering. After cooking, let stand, covered for 1 to 3 minutes.
6- Hot Dogs	1 - 6	1	Place hot dog in bun. Wrap each with paper towel or napkin. Enter the quantity of hot dogs and touch <b>START</b> .

# Microwave Operating Instructions (continued)

## TURBO COOKING

This oven has two pre-programmed settings that make it easy to cook with both convection heat and microwave automatically.

	Oven temperature	Microwave power
Turbo Roast	300°F	30%
Turbo Bake	325°F	10%

With the exception of those foods that cook best by convection heating alone, most foods are well suited to mix cooking using either Turbo Bake or Turbo Roast.

The marriage of these two cooking methods produces juicy meats, moist and tender cakes and fine textured breads, all with just the right amount of browning and crispness.

The temperatures can be changed; however, the microwave power cannot.

The oven temperature can be changed from 100°F to 450°F. When the display says SELECT TEMP, touch desired temperature pad. Ex: Turbo Roast pad, 7. The temperature will change to 375°F automatically.

### IMPORTANT - PREHEAT

To set the turbo mode with a preheat feature, you must press the turbo pad a second time.

When the oven has reached the desired temperature, it will prompt you to place food in the oven. Place food in the oven and press **START** to begin cooking.

- Suppose you want to bake a cake for 25 minutes on **Turbo Bake**.

1. Press **TURBO BAKE**.
2. Press **TURBO BAKE** again to preheat.
3. Select temperature by pressing a number pad.
4. Press **START**.
5. Enter cooking time by pressing the number pads.
6. Press **START**.

## NOTE

If you do not change the temperature, omit step 3.

## MORE OR LESS TIME ADJUSTMENT

Should you discover that you like any of the Sensor Modes, Auto Cook, Auto Reheat or Auto Defrost slightly more done, touch the **POWER LEVEL** pad once after touching your choice of pads or before touching **START** pad. The display will show MORE.

Should you discover that you like any of the Sensor Modes, Auto Cooks, Auto Reheat or Auto Defrost slightly less done, touch the **POWER LEVEL** pad twice after touching your choice of pads or before touching **START** pad. The display will show LESS.

## QUICK START

**Quick start** is a short-cut method to set time for 1-9 minutes at power level 100.

- Suppose you want to heat a cup of soup for two minutes.

1. Press number **2** on the numeric pad.

The oven will start after 5 seconds and will signal then turn off automatically when finished.

## ADD 30 SECONDS

**Add 30 seconds** provides a convenient way to extend cooking time by 30 seconds while the oven timer is counting down. It will add 30 seconds to the time shown each time the pad is touched.

This pad may also be used as a quick start for 30 seconds of cooking. No need to touch **START**, the oven will start immediately.

## Lower Oven Operating Instructions

### BAKE

Use the bake feature to cook most food items that require normal cooking temperatures.

The following temperature settings apply to the bake feature:

- Auto-suggest (default) setting: **350°F/177°C**
- Min. bake setting: **170°F / 76°C**
- Max. bake setting: **550°F / 288°C**

### Setting bake for lower oven

See example below to set a bake to start immediately at the default temperature.

1. Press **BAKE**
2. Press **START**

Once **START** is pressed the oven will begin heating. The oven display shows the temperature rising. While preheating the convection fan may operate.

After the oven reaches set temperature a beep will indicate the oven is ready. The oven will continue to maintain this temperature until the cooking feature is canceled.

### NOTE

You may press **STOP** any time when setting the control or during the cooking process.

If your recipe requires a different baking temperature than the auto-suggested (default) temperature (example below shows lower oven temperature set for 425°F/ 218°C):

1. Press **BAKE**
2. Enter the temperature by pressing the number pads **4 2 5**.
3. Press **START**

To add or change any cook settings after this feature has started:

- Press **BAKE** and use the numeric pads.
- If changing cooking times, select the **cook time** or **delay start** keys needed to make the changes.

### For best results

- As much as possible, use only one rack on position 2 or 3 and center the pans. If more racks or pans are needed, refer to the figures below.
- If using two racks, place the oven racks in position 2 and 4.
- When placing multiple food items in the oven allow 2-4" (5-10cm) of space between the food items for proper air circulation.
- Dark or dull pans absorb more heat than shiny bakeware resulting in dark or overbrowning of foods. It may be necessary to reduce the oven temperature or cook time to prevent overbrowning of some foods. Dark pans are recommended for pies. Shiny pans are recommended for cakes, cookies and muffins.

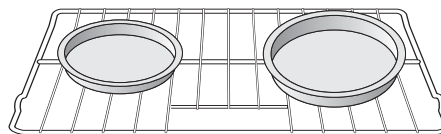

**Pan position for one rack baking.**  
(27" & 30" models)

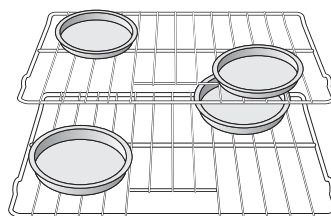

**Multiple Oven Racks**  
(27" Models)

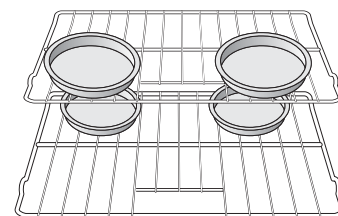

**Multiple Oven Racks**  
(30" Models)



## Lower Oven Operating Instructions (continued)

### COOK TIME

Adding a cook duration when baking is beneficial when a recipe requires a specific temperature and period of time to cook. Following the recipe cook time helps ensure the best possible results.

Cook time may be set with the following features:

- Bake
- Conv Bake
- Conv Roast
- Slow Cook

See example below to set the lower oven for bake, starting immediately with preheating to the auto-suggest (default) setting of 350°F (176°C) and then to automatically turn off after 30 minutes:

1. Press **BAKE**
2. Press **START**
3. Press **COOK TIME**
4. Enter **30** minutes
5. Press **START**

Once **START** is pressed the oven will cook and after 30 minutes automatically shut-off.

### NOTE

You may press **STOP** any time when setting the control or during the cooking process.

### When the Cook Time finishes:

1. “**End**” and the time of day will show in display. The oven will shut off automatically.
2. The control will beep 3 times. The control will continue to beep 3 times every 30 seconds until **STOP** is pressed.

### DELAY START (with cook time)

Adding a cook duration along with a specific start time gives the same benefits as the cook time option in addition to controlling exactly when the cooking process will begin and end.

Cook time and delay start may be set with the following features:

- Bake
- Conv Bake
- Conv Roast
- Slow Cook
- Flex Clean

See example below to set the lower oven with preheating for bake at 375°F (177°C) for 50 minutes and to automatically start at 5:30:

Preheat the oven if necessary

1. Press **BAKE**
2. Enter **375°F**
3. Press **START**
4. Press **COOK TIME**
5. Enter **50** minutes
6. Press **START**
7. Press **DELAY START**
8. Enter **5:30**
9. Press **START**

Once **START** is pressed, the oven will calculate the start time at which the oven will begin heating.

The oven will continue to maintain this temperature for the selected time or until the cooking feature is canceled.

### NOTE

When setting the **DELAY START** option be sure the correct time of day is set.

You may press **STOP** any time when setting the control or during the cooking process.

You may also choose to use **DELAY START** with no **COOK TIME**.

## Lower Oven Operating Instructions (continued)

### BROIL

Use the **broil** feature to cook meats that require direct exposure to radiant heat for optimum browning results.

The following temperature settings apply to the broil feature:

- Auto-suggest (default) setting: **550°F / 288°C**
- Min. broil setting: **400°F / 204°C**
- Max. broil setting: **550°F / 288°C**

### Setting broil for lower oven

See example below to set broil for the lower oven starting immediately with the auto-suggest (default) setting:

1. Place the broiler insert on the broiler pan, then place the meat on the insert. Remember to follow all warnings and cautions.
2. Arrange the interior oven rack to rack position recommendations -Figs. 2 & 3-. Be sure to place the prepared food and pan directly under broil element. **Close the oven door.**
3. Press **BROIL**
4. Press **START**

### NOTE

You may press **STOP** any time when setting the control or during the cooking process.

Leaving open the lower oven door for a minute while broiling will cause the electronic controls to prompt "dr" to remind you to close the door. If the oven door is not closed after 30 seconds, the controller will cancel the broiling.

### For best results

- Use the recommended pans and oven rack positions for the type of meat being prepared.
- For optimum browning results, allow the oven to preheat **5-6 minutes** before placing the food in the oven.

### CAUTION

- **Do not** use the broiler pan without the insert.
- **Do not** cover the broil pan/insert with aluminum foil; the exposed grease could ignite.
- To prevent food from contacting the broil element and to prevent grease splattering, **do not** use the roasting rack when broiling.

### WARNING

Should an oven fire occur, close the oven door. If the fire continues, throw baking soda on the fire or use a fire extinguisher. **Do not** put water or flour on the fire. Flour may be explosive and water can cause a grease fire to spread and cause personal injury.

The broil pan and its insert are available via the mail order card. The broil pan insert contains slots that allows grease from the meat to drain into the broil pan. Place prepared meat on broil pan insert and then place onto broiler pan as shown below.

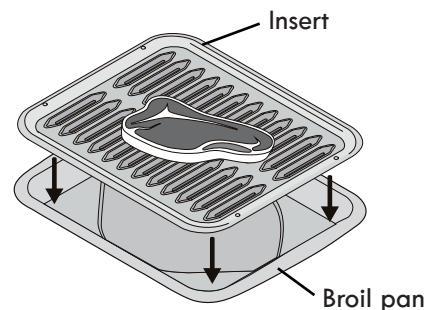

Food	Rack position	Temp	Cook time in minutes		Doneness
			1st side	2nd side	
Steak 1" thick	3rd or 4th	550°F	6	4	Rare
	3rd or 4th	550°F	7	5	Medium
	3rd or 4th	550°F	8	7	Well
Pork chops 3/4" thick	3rd or 4th	550°F	8	6	Well
Chicken-bone in	3rd	450°F	20	10	Well
Chicken-boneless	3rd or 4th	450°F	8	6	Well
Fish	3rd	500°F	13	0	Well
Shrimp	3rd	550°F	5	0	Well
Hamburger 1" thick	4th	550°F	9	7	Medium
	4th	550°F	10	8	Well

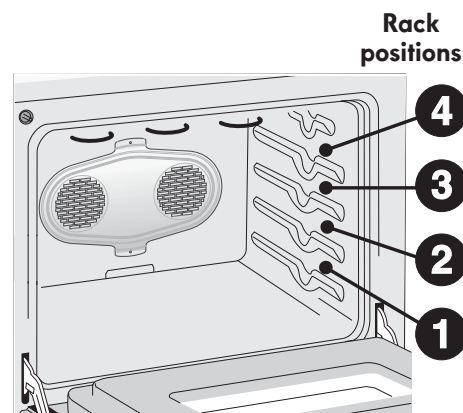

Model with dual fan shown only

## Lower Oven Operating Instructions (continued)

### CONVECTION BAKE

Convection Bake uses two fans to circulate the oven heat evenly and continuously. The improved heat distribution allows for even cooking with excellent results. Multiple rack cooking may slightly increase cook times for some foods, but the overall result is time saved.

The Conv Bake feature should **ONLY** be used when your recipe instructions have been written for use with convection baking.

If your recipe instructions are for normal baking and you wish to use convection bake, follow the **Convection Convert** option instructions. The convection convert option will automatically adjust the oven temperature so that convection baking may provide the best possible results.

Conv Bake may be set with the following options:

- Conv Convert
- Cook Time and/or Delay Start

#### Benefits of convection bake:

- Superior multiple oven rack performance.
- Some foods cook up 25 to 30% faster, saving time and energy.
- No special pans or bakeware required.

#### For best results

- When baking with a single rack use rack positions 2 or 3. When using 2 racks use rack positions 2 & 4. When using 3 racks use rack positions 1, 3 (offset rack) & 4.
- Cookies and biscuits should be baked on pans with no sides or very low side to allow heated air to circulate around the food.
- Food baked on pans with a dark finish will cook faster.
- When placing multiple food items in the oven allow 2-4" (5-10cm) of space between the food items for proper air circulation.

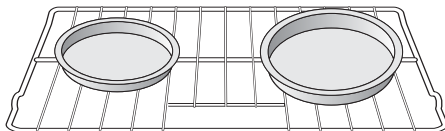

Pan position for one rack baking.  
(27" & 30" models)

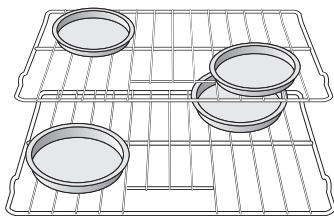

Multiple Oven Racks  
(27" Models)

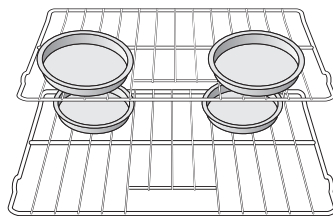

Multiple Oven Racks  
(30" Models)

The following temperature settings apply to the conv bake feature:

- Auto-suggest (default) setting: **350°F / 177°C**
- Min. bake setting : **170°F / 76°C**
- Max. bake setting: **550°F / 288°C**

See the example below to set conv bake, starting immediately with the auto-suggest (default) setting of 350°F (177°C):

1. Press **CONV BAKE**
2. Press **START**

After the oven reaches set temperature, a beep will indicate the oven is ready. The oven will continue to maintain this temperature until the cooking feature is canceled.

#### NOTE

You may press **STOP** any time when setting the control or during the cooking process.

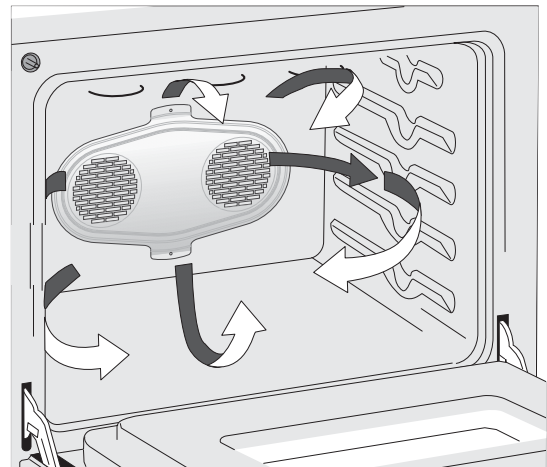

Convection air flow  
Model with dual fan  
shown only

## Lower Oven Operating Instructions (continued)

### CONVECTION CONVERT

The conv convert option allows you to convert any normal baking recipe using the convection bake feature. The control uses the normal recipe settings and adjusts to a lower temperature for convection baking. Conv convert must be used with Conv Bake feature.

#### Benefits of conv bake using conv convert option:

- Superior multiple oven rack performance.
- Some foods cook up 25 to 30% faster, saving time and energy.
- No special pans or bakeware required.

#### For best results

- Place food items using the recommended rack positions. When baking with a single rack use rack positions 2 or 3. When using 2 racks use rack positions 2 & 4. When using 3 racks use rack positions 1, 3 (offset rack) & 4.
- Cookies and biscuits should be baked on pans with no sides or very low side to allow heated air to circulate around the food.
- Food baked on pans with a dark finish will cook faster.
- When placing multiple food items in the oven allow 2-4" (5-10cm) of space between the food items for proper air circulation.

See the example below to set conv bake, starting immediately with the auto-suggest (default) setting of 350°F (177°C) and adding the conv convert option.

1. Press **CONV BAKE**
2. Press **CONV CONVERT**
3. Press **START**

After the oven reaches the converted set temperature, a beep will indicate the oven is ready.

The added conv convert option will automatically **lower** the set temperature you set from the bake recipe to an adjusted conv bake temperature.

When conv convert is used with cook time "**CF**" (Check Food) will be displayed when the cook time is 75% complete. The control will also beep at regular intervals until baking has finished. For the Check Food function to operate, the cook time must be entered before the Conv Convert pad is pressed.

#### NOTE

You may press **STOP** any time when setting the control or during the cooking process.

## Lower Oven Operating Instructions (continued)

### CONVECTION ROAST

Convection roast combines a cook cycle with the convection fan and element to rapidly roast meats and poultry. Heated air circulates around the meat from all sides, sealing in juices and flavors. Meats cooked with this feature are crispy brown on the outside while staying moist on the inside. In addition, there is no need to reduce the oven temperature when using convection roast.

Convection roast may be set with the following options:

- Cook time or cook time with delay start

The following temperature settings apply to convection roast:

- Factory auto-start default: **350°F/177°C**
- Minimum: **170°F / 76°C**
- Maximum: **550°F / 288°C**

#### Benefits of convection roast:

- Superior multiple oven rack performance.
- Some foods cook up 25 to 30% faster, saving time and energy.
- No special pans or bakeware required.

#### For best results

- Preheating is not necessary for most meats and poultry.
- Place food items using the recommended rack positions for the type of food being prepared.
- When placing multiple food items in the oven allow 2-4" (5-10cm) of space between the food items for proper air circulation.
- Be sure to carefully follow your recipe's temperature and time recommendations or refer to the convection roast chart for additional information.

See example below to set convection roast to start immediately with the auto-suggest (default) setting:

1. Press **CONV ROAST**
2. Press **START**

Once START is pressed the oven will begin heating.

#### NOTE

You may press **STOP** any time when setting the control or during the cooking process.

#### Roasting rack instructions

The broil pan, its insert and the roasting rack are available via the mail order card. When preparing meats for convection roasting, you may use the broiler pan, insert and the roasting rack supplied with your appliance. The broiler pan will catch grease spills and the insert will help prevent grease splatters. The roasting rack fits on top of the insert allowing the heated air to circulate under the food for even cooking and helps to increase browning on the underside.

1. Place oven rack on bottom or next to the bottom oven rack position.
2. Place the insert on the broiler pan.
3. Make sure the roasting rack is securely seated on top of the insert. **Do not** use the broiler pan without the insert. **Do not** cover the insert with aluminum foil.
4. Position food (fat side up) on the roasting rack. -Fig. 1-
5. Place prepared food on oven rack in the oven.

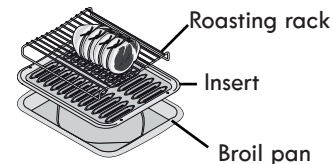

Meat		Weight	Oven temp	Internal temp	Minute per lb.
Beef	Standing rib roast	4 to 6 lbs.	350°F	*	25-30
	Rib eye roast	4 to 6 lbs.	350°F	*	25-30
	Tenderloin roast	2 to 3 lbs.	400°F	*	15-25
Poultry	Turkey, whole**	12 to 16 lbs.	325°F	180°F	8-10
	Turkey, whole**	16 to 20 lbs.	325°F	180°F	10-15
	Turkey, whole**	20 to 24 lbs.	325°F	180°F	12-16
	Chicken	3 to 4 lbs.	350°F - 375°F	180°F	12-16
Pork	Ham roast, fresh	4 to 6 lbs.	325°F	160°F	30-40
	Shoulder blade roast	4 to 6 lbs.	325°F	160°F	20-30
	Loin	3 to 4 lbs.	325°F	160°F	20-25
	Pre-cooked ham	5 to 7 lbs.	325°F	160°F	30-40

\* For beef: med rare 145°F, med 160°F, well done 170°F

\*\* Stuffed turkey requires additional roasting time. Shield legs and breast with foil to prevent overbrowning and drying of the skin.

## Lower Oven Operating Instructions (continued)

### MEAT PROBE

Checking the internal temperature of your food is the most effective way of ensuring that your food has been properly cooked. When cooking meat such as roasts, hams or poultry you can use the probe to check the internal temperature without any guesswork.

Your oven will automatically change from cooking to keep warm once the probe has reached the set temperature.

The following temperature settings apply to the probe function:

- Default: **170°F / 76°C**
- Minimum: **130°F / 54°C**
- Maximum: **210°F / 99°C**

### Proper probe placement

- Always insert the probe so that the tip rests in the center of the thickest part of the meat. Do not allow the probe to touch bone, fat, gristle or the pan.
- For bone-in ham or lamb, insert the probe into the center of the lowest large muscle or joint. For dishes such as meat loaf or casseroles, insert the probe into the center of the food. To find the center of the food visually measure with the probe -Fig. 3-. When cooking fish, insert the probe just above the gill.
- For whole poultry or turkey, insert the probe into the thickest part of the inner thigh, below the leg -Fig. 1-.

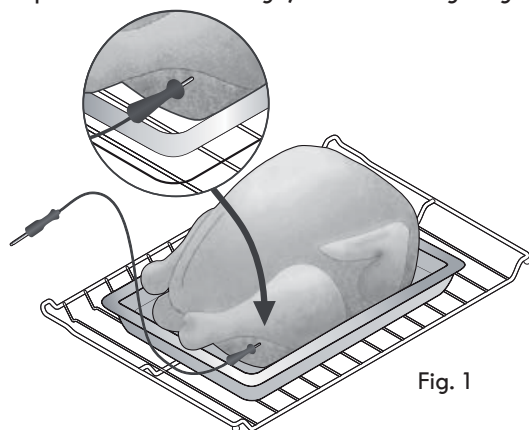
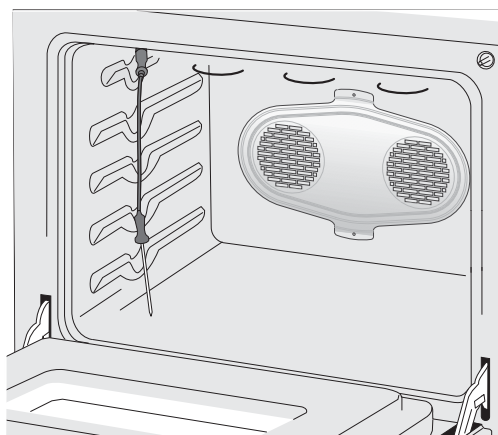

Fig. 1



Model with dual fan shown only

Fig. 2

See the example below to set the probe target temperature to 180°F/82°C when using the convection roast feature with oven set temperature for 325°F/162°C.

1. Insert the probe into the food and place the food into the oven -Fig. 1-.
2. Plug the probe **COMPLETELY** into the probe receptacle inside the oven -Fig. 2- and close the oven door.
3. Press **CONV ROAST**
4. Enter **325**
5. Press **START**
6. Press **MEAT PROBE**
7. Enter **180**
8. Press **START**

At this time, the actual meat probe temperature will be displayed.

\* You may skip step 7 if you choose to use the default internal target temperature of 170°F for the probe.

By the default, your oven will adjust to the **Warm & Hold** setting once the probe has reached the set temperature.

### IMPORTANT

- Use only the probe supplied with your appliance; any other may result in damage to the probe or the appliance.
- Be sure the probe is **fully** inserted into the probe receptacle. The probe will not work properly until correctly connected.
- Handle the probe carefully when inserting and removing it from the food and the receptacle.
- Do not use tongs to pull the cable when inserting or removing it from the food or the receptacle.
- Defrost your food completely before inserting the probe to avoid damaging probe.
- **Never leave or store the probe inside the oven when not in use.**
- To prevent the possibility of burns, carefully unplug the probe using a pot holder.

### NOTE

- When the meat probe is connected to the receptacle and a cooking function is started, the display will show the current temperature reported by the meat probe.
- Any time during the cooking process you may press **MEAT PROBE** to modify the target temperature.

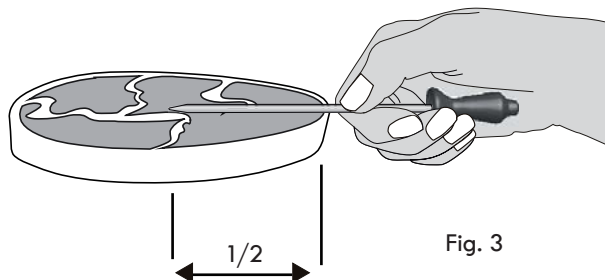

Fig. 3

## Lower Oven Operating Instructions (continued)

### SLOW COOK

The slow cook feature may be used to cook foods more slowly at lower oven temperatures. The cooking results will be like that of a Slow Cooker or Crock-Pot. This feature is ideal for roasting beef, pork & poultry. Slow cooking meats may result in the exterior of meats becoming dark but not burnt; this is normal.

Slow cook may be set with the following options:

- Cook time
- Cook time and/or delay start

The following temperature settings apply to the slow cook feature:

- Hi: 275°F / 134°C (default) for cooking 4 to 5 hours
- Lo: 225°F / 108°C for cooking 8 to 9 hours

See the example below to set a slow cook.

1. Press **SLOW COOK** to choose the Hi option -Fig. 1-.
2. Press **SLOW COOK** again to choose the Lo option -Fig. 2-.
3. Press **START**



Fig.1



Fig. 2

### NOTE

You may press STOP any time when setting the control or during the cooking process.

### For best results

- Completely thaw all frozen foods before cooking.
- Position multiple racks to accommodate size of cooking utensils when cooking multiple food items.
- Add any cream or cheese sauces during the last hour of cooking.
- Do not open the oven door often or leave the door open when checking foods. The more heat that is lost, the longer the food will need to cook.
- Cover the foods to keep them moist or use a loose or vented type cover to allow foods to turn crisp or brown.
- Roasts may be left uncovered so browning can occur. Cook times will vary depending on the weight, fat content, bone & the shape of the roast.
- Preheating the oven will not be necessary.

### WARM & HOLD

The Warm & Hold feature will maintain an oven temperature of 170°F (77°C). The Warm & Hold feature will keep oven baked foods warm for serving up to 3 hours after cooking has finished. After 3 hours the Warm & Hold feature will shut the oven OFF. The Warm & Hold feature may be used without any other cooking operations or may be used after cooking has finished using Cook Time or Delay Start.

See example below to set warm & hold for the lower oven to start immediately.

1. Press **WARM & HOLD**
2. Press **START**

See example below to set warm & hold for the lower oven to start after a Cook Time or Delay Start.

1. Set the oven properly for **COOK TIME** or **DELAY START**.
2. Press **WARM & HOLD**.
3. Press **START**

### NOTE

After 3 hours the Warm & Hold feature will shut the oven OFF.

You may press STOP any time when setting the control or during the cooking process.

## Lower Oven Operating Instructions (continued)

### SABBATH MODE

This appliance provides special settings for use when observing the Jewish Sabbath/Holidays. This mode will turn off all audible tones or visual display changes normally provided by the oven control. **BAKE** is the only cooking features available while in the Sabbath mode.

You must first set the **BAKE** feature and temperature(s) needed for the lower oven, the **COOK TIME** option if needed before setting the Sabbath mode. Any settings made prior to setting the Sabbath mode will be visible in the displays.

The Sabbath mode will override the factory preset 12 Hour Energy Saving mode and the appliance will stay on until the cooking features are cancelled. If any of the cooking features are cancelled when the appliance is in the Sabbath mode, no audible or visual indicators will be available to verify the cancellation.

If the oven interior lights are needed, be sure to activate them prior to setting the Sabbath mode. Once the oven light is turned ON and the Sabbath mode is active, the oven light will remain on until the Sabbath mode is turned off and the oven lights are turned off. The oven door will not activate the oven interior lights when the oven door is opened or closed.

It is recommended that any oven temperature modification made within an active Sabbath mode be followed with 2 presses of the **START** key. This will ensure the oven remains ON even if an attempt is made to set the oven temperature outside of its temperature range. If the oven temperature is set outside of the temperature range, the oven will default to the nearest available temperature. Try to set the desired oven temperature again.

Should a power failure or interruption occur during the Sabbath/Holidays, the appliance will shut OFF. When power is restored the appliance will not turn back on automatically to the original **BAKE** feature settings. **SF** will appear in all the control display panels indicating a Sabbath mode failure. After a power failure, the food may be safely removed from the oven while still in the Sabbath mode.



For further assistance, guidelines for proper usage and a complete list of models with the Sabbath feature, please visit the web at <http://www.star-k.org>.

### NOTE

**No Sabbath mode is available for microwave oven. Do not use the microwave oven when the Sabbath mode is enabled.**

### SETTING SABBATH MODE

The example below shows setting the oven to observe the Sabbath (and Jewish holidays).

1. Press **BAKE**.
2. Press **START**

Be sure to make any additional oven setting changes before going to step 3.

3. To enter Sabbath mode, press and hold **simultaneously** both the **COOK TIME** and **DELAY START** keys together for 3 seconds (a beep will sound) and release.

Once properly set in Sabbath mode, SAb will show in the oven display until the Sabbath mode is cancelled.

### CANCELING SABBATH MODE

The example below shows how to cancel the Sabbath mode.

1. Press and hold both the **COOK TIME** and **DELAY START** keys together for 3 seconds (a beep will sound) and release.
2. All cooking features previously set will automatically cancel once Sabbath mode has ended.

### NOTE

The only keys available once the appliance is set for the Sabbath mode are **BAKE**, **START**, **STOP** and the **numeric pads**.

You may change the oven temperature once baking has started (Jewish holidays only). Press **BAKE**, enter the oven temperature using the numeric keys and press **START twice**. Remember that **the oven control will no longer beep or display any further changes** once the oven is set in the Sabbath mode.



## Lower Oven Operating Instructions (continued)

### RECIPE RECALL

The Recipe Recall feature may be used to record and recall your favorite recipe settings. This feature may store 1 setting for each of the 3 basic cooking pads. The key pad that a recipe may be stored with are **Bake**, **Conv Bake** and **Conv Roast**. This feature will also store and recall Cook Time or Warm & Hold added setting. Note: Pressing the Start pad after entering cooking temperatures and times will start the oven. If you wish to store the recipes but not start the oven press STOP after pressing the START pad. Once a recipe has been stored the recipe information will appear in the display when pressing the pad in future.

See example below to store a typical cookie recipe (example for baking at 375°F for 9 minutes and to shut-off automatically).

Preheat\* the oven to the desired temperature.

1. Press **BAKE**.
2. Press **3 7 5**.
3. Press **START**.
4. Press **COOK TIME**.
5. Enter the desired baking time. Press **9**.
6. Press and hold **START** for 3 seconds.

This recipe is now stored with the **Bake** key pad.

\* The **Cook Time** you enter does NOT include additional time required to **Preheat** the oven. The oven will begin to count down the cooking time as soon as the feature is activated.

See example below to recall a previously stored recipe under BAKE pad.

1. Press **BAKE**. The stored recipe is recalled.
2. Press **START**.

See example below to quickly erase all stored recipes.

1. Press and hold **CONV CONVERT** until the first single beep sounds (6 seconds).
2. After the first beep press the **START** pad once. Any stored recipes will be erased.

### NOTE

Clearing the recipes will also reset all other adjustments back to the factory settings. These include 12 or 24 Hour Time of Day display, Continuous Bake or 12 Hour Energy Savings mode, Silent Control Operation, Fahrenheit or Celsius Temperature Display and any Oven Temperature adjustments that are set.

## User Preferences

### SETTING CLOCK

See the example below to set the clock to 1:30.

1. Press .
2. Enter **1:30** to advance to 1:30.
3. Press **START** to accept or press **STOP** to reject.

### SETTING 12 OR 24 HOUR MODE

The clock display mode allows you to choose between 12 and 24 hour mode. The factory preset clock display mode is 12 hour.

See the example below to change the default mode to 24 hour.

1. Press and hold  for 7 seconds until **CLOCK 12Hr** or **24Hr** appear in the display.
2. Press **FLEX CLEAN** to switch between the 12 and 24 hour mode.
3. Press **START** to accept or press **STOP** to reject.

### ADJUSTING OVEN TEMPERATURE

#### User preference offset

Your appliance has been factory calibrated and tested to ensure an accurate baking temperature. For the first few uses, follow your recipe times and temperature recommendations carefully.

If you feel your oven is too hot or too cool from your baking experience, the oven temperature may be adjusted to your liking. The temperature may be increased up to +35°F (+19°C) or decreased down to -35°F (-19°C) from normal.

See the example below to increase the temperature in the **lower oven**.

1. Press and hold **BAKE** for 7 seconds until **USER** appear in the display.
2. Enter the desired temperature change using the number pads. **FLEX CLEAN** can be pressed to lower the temperature.
3. Press **START** to accept or press **STOP** to reject.

### CHANGING BETWEEN F° OR C°

Your control has the ability to display and set Fahrenheit or Celsius temperatures. The factory preset temperature display is Fahrenheit.

See the example below to change the default temperature display to Celsius.

1. Press and hold **BROIL** for 7 seconds until **F** or **C** appear in the display.
2. Press **FLEX CLEAN** to switch between the **F** and **C** mode.
3. Press **START** to accept or press **STOP** to reject.

### SETTING AUDIO MODE

The audio mode allows you to control the audio for the oven control. You may turn the audio off and later return to operating with all the normal audible sounds and alerts.

See the example below when changing the audible settings.

1. Press and hold **DELAY START** for 7 seconds until **AUDIO** appears in the display.
2. Press **FLEX CLEAN** to switch between the **On** and **Off** mode.
3. Press **START** to accept or press **STOP** to reject.

### SETTING 12HR ENERGY SAVING MODE

The oven control has a factory preset built-in 12 hour energy saving feature that will shut off the appliance if the oven has been heating for more than 11 hours and 59 minutes. The oven can be programmed to override this feature for continuous baking.

See the example below to turn off 12 hour energy saving mode.

1. Press and hold **TIMER** for 7 seconds until **En-SAVER** appears in the display.
2. Press **FLEX CLEAN** to switch between the **On** and **Off** mode.
3. Press **START** to accept or press **STOP** to reject.

## Lower Oven Self-Cleaning Cycle

### BEFORE STARTING SELF-CLEAN

A self-cleaning oven automatically cleans with high temperatures that are well above those used for normal cooking. The self-clean feature eliminates soils completely or reduces them to a fine powdered ash that you can later easily wipe away with a damp cloth.

Adhere to the following precautions when running the self-clean cycle:

- Allow the oven to cool before cleaning.
- Wear rubber gloves when cleaning any exterior parts of the oven manually.
- **Do not** use oven cleaners or protective coatings in or around the oven interior.
- **Do not** clean the oven door gasket. The woven material of the oven door gasket is essential for a good seal. Care should be taken not to rub, damage or remove the gasket. -Fig. 1-
- **Do not** use any cleaning materials on the door gasket. Leaving chemical residue can damage the door gasket.
- **Do not** force the oven door open. The automatic door locking system can be damaged.
- **Remove all utensils and any aluminum foil from the oven.** These items cannot withstand high cleaning temperatures.
- This oven comes with lubricated porcelain oven racks, which can remain in the oven during the self-clean cycle. Do not clean this vegetable oil lubrication off the racks. It is important that the sides of the oven racks always have a light coating of vegetable oil. To maintain optimal rack performance, re-apply a thin layer of vegetable oil to the sides of the rack after every self-clean cycle or when the rack becomes difficult to slide.
- **Remove any excessive spillovers** in the oven cavity **before** starting a self-clean cycle. To clean, use hot, soapy water and a cloth. Large spillovers can cause heavy smoke or fire when subjected to high temperatures.
- Clean any soil from the oven frame, the door liner outside the oven door gasket and the small area at the front center of the oven bottom with soap and water. These areas heat sufficiently to burn soil on.
- **Do not** allow food spills with a high sugar or acid content (such as milk, tomatoes, sauerkraut, fruit juices or pie filling) to remain on the porcelain surface, they may leave a dull spot even after cleaning.

### ⚠ WARNING

During the self-clean cycle, the outside of the appliance can become very hot to the touch. **DO NOT** leave small children unattended near the appliance.

### ⚠ CAUTION

- **DO NOT** line the oven walls, oven racks, bottom or any other part of the appliance with aluminum foil. Doing so will stop heat distribution, produce poor baking results and cause permanent damage to the oven interior (aluminum foil will melt to the interior surface of the oven).
- **DO NOT** force the oven door open. This can damage the automatic door locking system. Use caution when opening the door after the self-clean cycle is finished. The oven may still be **VERY HOT**.
- The health of some birds is extremely sensitive to the fumes given off during the self-cleaning cycle of any appliance. Move birds to another well-ventilated room.

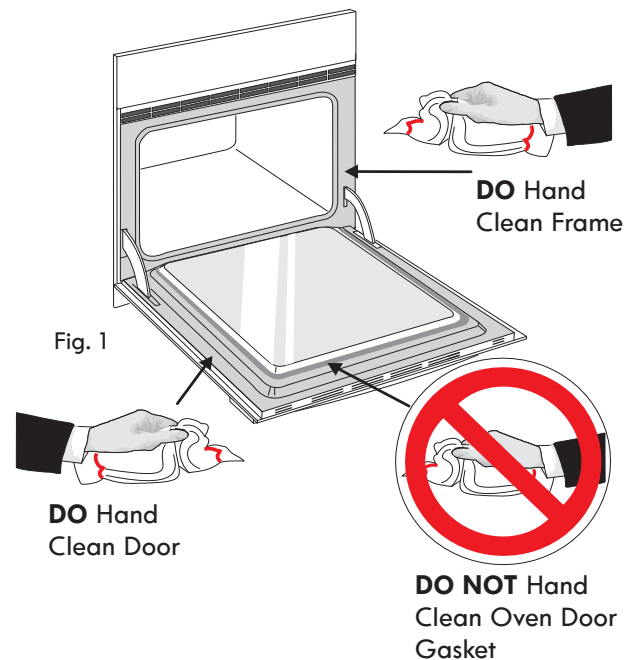

### What to Expect during Cleaning

While the oven is in operation, the oven heats to temperatures much higher than those used in normal cooking. Sounds of metal expansion and contraction are normal. Odor is also normal as the food soil is being removed. Smoke may appear through the oven vent.

If heavy spillovers are not wiped up before cleaning, they may flame and cause more smoke and odor than usual. This is normal and safe and should not cause alarm. If available, use an exhaust fan during the self-cleaning cycle.

## Lower Oven Self-Cleaning Cycle

### SELF-CLEAN CYCLE

The **FLEX CLEAN** pad controls the Self-Cleaning feature. When used with a Delay Start pad, a delayed Self-Cleaning cycle may also be programmed. The Flex Clean feature allows for any Self-Cleaning cycle time from 2 (2:00) to 4 hours (4:00). You may also choose the clean time in 1 minute increments (for example 2 hours and 50 minutes) by pressing the corresponding number keypads.

If you are planning to use the oven directly after a self-clean cycle remember to allow time for the oven to cool down and the oven door to unlock. This normally takes about one hour. So a 3 hour self-clean cycle will actually take about 4 hours to complete.

\*It is recommend to use a 2 hour self-clean cycle for **light soils**, a 3 hour cycle for **average soils**, and a 4 hour cycle for **heavy soils** (to assure satisfactory results).

**NOTE:** The kitchen area should be well ventilated using an open window, ventilation fan or exhaust hood during the Self-Clean cycle. This will help eliminate the normal odors associated with the Self-Clean cycle.

See example below to start an immediate Self-Cleaning cycle or to set a Delay Start time of 9:00 o'clock and shut-off automatically (example provided is a default 3 hour Self-Clean cycle)

1. Be sure the clock is set with the correct time of day, the oven is **EMPTY** and the oven door is closed.
2. Press **FLEX CLEAN**.

The control will automatically clean for a 3 hour period (default self-cleaning cycle time). Note: If a 2 or 4 hour clean time is desired, press **2 0 0** for 2 hour or press **4 0 0** for a 4 hour clean time. Set the cleaning time based on the amount of soil: light, medium or heavy (\*See above).

3. Press **START**.

As soon as the control is set, the motor driven oven door lock will begin to close automatically. Once the door has been locked the "**DOOR LOCKED**" indicator light will stop flashing and remain on.

**Note:** Allow about 15 seconds for the oven door lock to close.

**Note: If the optional delay Self-Clean feature is needed, finish steps 4-6.**

4. Press **DELAY START**.
5. Enter the desired Self-Clean starting time using the number pads **9 0 0**.
6. Press **START**.

The control will calculate forward from the set start time to determine when the Self-Cleaning cycle should end. The Self-Cleaning cycle will turn on automatically at the set time.

### CAUTION

- To avoid possible burns use care when opening the oven door after the Self-Cleaning cycle. Stand to the side of the oven when opening the door to allow hot air or steam to escape.
- **DO NOT** force the oven door open. This can damage the automatic door locking system. Use caution and avoid possible burns when opening the door after the Self-Cleaning cycle has completed. The oven may still be **VERY HOT**.

### When the Self-Clean Cycle is Completed

Once the oven has cooled down for approximately 1 HOUR, and the "**DOOR LOCKED**" icon is no longer displayed, the oven door can then be opened.

### Stopping or Interrupting a Self-Cleaning Cycle

If it becomes necessary to stop or interrupt a self-cleaning cycle due to excessive smoke or fire in the oven:

1. Press **STOP**.
2. Once the oven has cooled down for approximately 1 HOUR, and the "**DOOR LOCKED**" icon is no longer displayed, the oven door can then be opened.

### NOTE (30" model only)

A smoke eliminator in the oven vent converts most of the smoke into a colorless vapor.

### IMPORTANT

If a self-clean cycle was started but did not finish due to a power failure, your oven may not be completely cleaned. After power has been restored and the oven door has unlocked, set for another self-clean if needed.

# Microwave General Care & Cleaning

**Disconnect the power cord before cleaning or leave the door open to inactivate the oven during cleaning.**

## Exterior

Clean the outside with mild soap and water; rinse and dry with a soft cloth. Do not use any type of household or abrasive cleaner.

## Door

Wipe the window on both sides with a damp cloth to remove any spills or splatters. Metal parts will be easier to maintain if wiped frequently with a damp cloth. Avoid the use of spray and other harsh cleaners as they may stain, streak or dull the door surface.

## Touch Control Panel

Care should be taken in cleaning the touch control panel. If the control panel becomes soiled, open the Microwave Oven door before cleaning. Wipe the panel with a cloth dampened slightly with water only. Dry with a soft cloth. Do not scrub or use any sort of chemical cleaners. Close door and touch **STOP/CLEAR**.

## Interior

Cleaning is easy because little heat is generated to the interior surfaces; therefore, there is no baking and setting of spills or spattering. To clean the interior surfaces, wipe with a soft cloth and warm water. **DO NOT USE ABRASIVE OR HARSH CLEANERS OR SCOURING PADS.** For heavier soil, use baking soda or a mild soap; rinse thoroughly with hot water. The rack can be cleaned with hot soapy water, rinsed and dried. **NEVER SPRAY OVEN CLEANERS DIRECTLY ONTO ANY PART OF THE MICROWAVE OVEN.**

## Waveguide Cover

The waveguide cover is made from mica so requires special care. Keep the waveguide cover clean to assure good oven performance. Carefully wipe with a damp cloth any food splatters from the surface of the cover immediately after they occur. Built-up splashes may overheat and cause smoke or possibly catch fire. Do not remove the waveguide cover.

## Odor Removal

Occasionally, a cooking odor may remain in the oven. To remove, combine 1 cup water, grated peel and juice of 1 lemon and several whole cloves in a 2-cup glass measuring cup. Boil for several minutes using 100% power. Allow to set in oven until cool. Wipe interior with a soft cloth.

## Turntable/Turntable Support/Racks

The turntable, turntable support and racks can be removed for easy cleaning. Wash them in mild, sudsy water; for stubborn stains use a mild cleanser and a non-abrasive scouring sponge. They are also dishwasher-proof. Use top rack of dishwasher for turntable support.

Foods with high acidity, such as tomatoes or lemons, will cause the porcelain enamel turntable to discolor. Do not cook highly acidic foods directly on the turntable; if spills occur, wipe up immediately.

The turntable motor shaft is not sealed, so excess water or spills should not be allowed to stand in this area.

## Lower Oven General Care & Cleaning

Before cleaning any part of the oven, be sure all controls are turned OFF and the oven is COOL. REMOVE SPILLOVERS AND HEAVY SOILING AS SOON AS POSSIBLE. REGULAR CLEANINGS NOW WILL REDUCE THE EXTENT AND DIFFICULTY OF MAJOR CLEANING LATER.

Surface Type	Cleaning Recommendation
Aluminum (trim pieces) & vinyl	Use hot, soapy water and a cloth. Dry with a clean cloth.
Painted and plastic control knobs Body parts, Painted decorative trim	For general cleaning, use hot, soapy water and a cloth. For more difficult soils and built-up grease, apply a liquid detergent directly onto the soil. Leave on soil for 30 to 60 minutes. Rinse with a damp cloth and dry. <b>Do not</b> use abrasive cleaners on any of these materials; they can scratch. To remove control knobs, turn to the OFF position; grasp firmly and pull straight off the shaft. To replace knobs after cleaning, line up the flat sides of both the knob and the shaft; then push the knob into place.
Chrome control panel (some models) Decorative trim (some models) Stainless steel (some models)	<p>Before cleaning the control panel, turn all controls to OFF and remove the control knobs. To remove, pull each knob straight off the shaft. Clean using hot, soapy water and a dishcloth. Rinse with clean water using a dishcloth. Be sure to squeeze excess water from the cloth before wiping the panel; especially when wiping around the controls. Excess water in or around the controls may cause damage to the appliance. To replace knobs after cleaning, line up the flat sides of both the knob and the shaft; then push the knob into place.</p> <p><b>Stainless Steel</b> (some models). Clean the stainless with warm soapy water using a clean sponge or cloth. Rinse with clean water and dry with a soft clean cloth. <b>Do not</b> use harsh scrubbing cleaners. Only use kitchen cleaners that are especially made for cleaning Stainless Steel. Always be sure to rinse the cleaners from the surface as bluish stains may occur during heating that cannot be removed.</p>
Porcelain enamel broiler pan and insert (if equipped) Door liner & body parts	Gentle scouring with a soapy scouring pad will remove most spots. Rinse with a 1:1 solution of clear water and ammonia. If necessary, cover difficult spots with an ammonia-soaked paper towel for 30 to 40 minutes. Rinse with clean water and a damp cloth, and then scrub with a soap-filled scouring pad. Rinse and wipe dry with a clean cloth. Remove all cleaners or the porcelain may become damaged during future heating.
Oven racks	<p>This oven comes with lubricated porcelain oven racks, which can remain in the oven during the self-clean cycle. Do not clean this vegetable oil lubrication off the racks. It is important that the sides of the oven racks always have a light coating of vegetable oil. To maintain optimal rack performance, re-apply a thin layer of vegetable oil to the sides of the rack after every self-clean cycle or when the rack becomes difficult to slide.</p> <p>For some models with chrome oven racks, clean by using a mild, abrasive cleaner following manufacturer's instructions. Rinse with clean water and dry.</p>
Oven door	<p>Use soap &amp; water to thoroughly clean the top, sides and front of the oven door. Rinse well. You may use a glass cleaner on the outside glass of the oven door. <b>Do not</b> immerse the door in water. <b>Do not spray or allow water or the glass cleaner to enter the door vents.</b> Do not use oven cleaners, cleaning powders or any harsh abrasive cleaning materials on the outside of the oven door.</p> <p><b>Do not</b> clean the oven door gasket. The oven door gasket is made of a woven material, on Self-Cleaning models, which is essential for a good seal. Care should be taken not to rub, damage or remove this gasket.</p>

## Lower Oven General Care & Cleaning (continued)

### REMOVING AND REPLACING THE LOWER OVEN DOOR

#### CAUTION

The oven door is heavy. Be careful when removing and lifting the door. Do not lift the oven door by the handle.

#### To Remove Oven Door:

1. Open oven door completely (horizontal with floor - See Figure 1).
2. Pull the door hinge locks on both left and right door hinges down from the oven frame completely towards the oven door (See Figure 2). A tool such as a small flat-blade screwdriver may be required.
3. Firmly grasp both sides of oven door along the door sides (Do not use the oven door handle - See Figure 3).
4. Close the door to the broil stop position (the oven door will stop into this position just before fully closing).
5. With the oven door in the broil stop position, lift the oven door hinge arms over the roller pins located on each side of the oven frame (See Figure 4).

#### To Replace Oven Door:

1. Firmly grasp both sides of oven door along the door sides (Do not use the oven door handle - See Figure 3).
2. Holding the oven door at the same angle as the removal position, seat the hook of the hinge arm onto the roller pins located on each side of the oven door frame (See Fig. 4). Also, seat the notch of the hinge arm onto the bottom of the slot at the same time you seat the hook. The hook and notch of the hinge arms must be fully seated onto the roller pins and bottom of the slot.
3. Fully open the oven door (horizontal with floor - See Figure 1).
4. Push the door hinge locks up towards and into the oven frame on both left and right oven door hinges (See Figure 2) to the locked position.
5. Close the oven door.

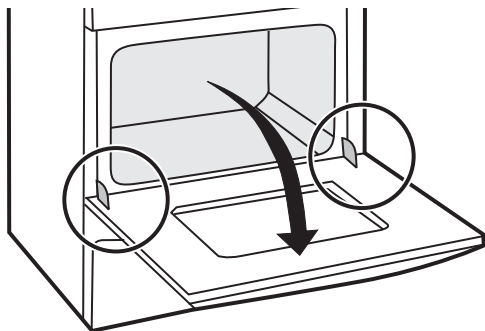

Door Hinge locations  
with oven door fully open

Figure 1

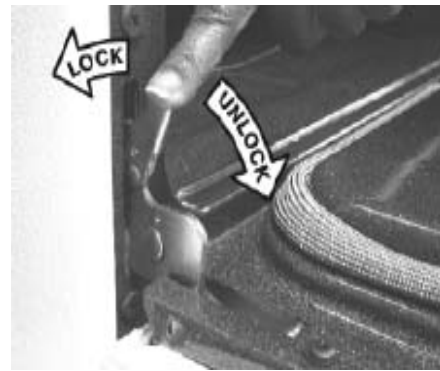

Figure 2

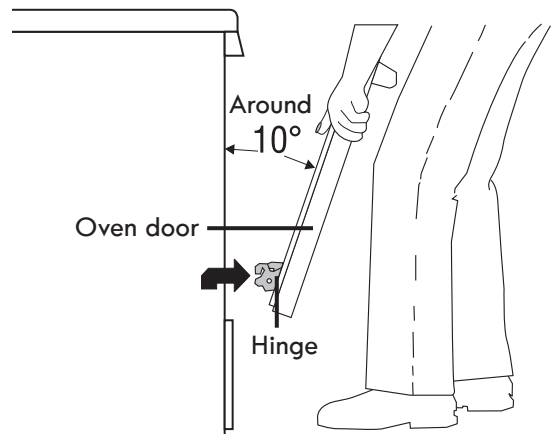

Figure 3

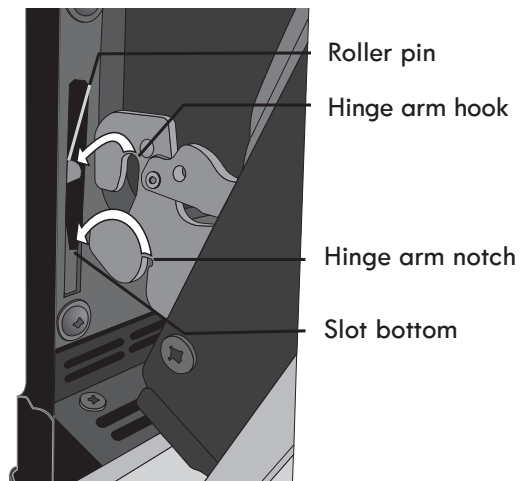

Figure 4

## Lower Oven General Care & Cleaning (continued)

### SPECIAL DOOR CARE INSTRUCTIONS

#### IMPORTANT

Most oven doors contain glass that can break. Read the following recommendations:

- **Do not** close the oven door until all the interior oven racks are fully inserted and retracted to the back of the oven.
- Do not hit the glass with pots, pans, or any other object. The oven door glass may break or even break at a later time unexpectedly.
- Scratching, hitting, jarring or stressing the oven door glass may weaken its structure causing an increased risk of breakage at a later time.
- You may use a glass cleaner on the outside of the oven door glass. **Do not spray** or allow water or the cleaner to enter or drip down into the oven door vents. Spray cleaner on cloth first and then wipe the oven door clean.
- **Do not** use strong oven cleaners, powders or any harsh abrasive cleaning materials on the outside of the oven door or glass.
- **Never clean** the oven door gasket. The oven door gasket should always clean during the Self-clean cycle.

### CHANGING LOWER OVEN LIGHTS

#### CAUTION

- Be sure the appliance is unplugged and all parts are **COOL** before replacing oven light. Wear a leather-faced glove for protection against possible broken glass or burns.

The lower oven light bulbs are located on both side of the oven cavity and both are covered with a glass shield. The glass shield must be in place whenever the oven is in use.

#### Replacing the lower oven interior light bulbs:

1. Turn electrical power off at the main source or unplug the appliance.
2. Remove lower oven interior light shield as illustrated below.
3. Replace bulb with a new **T-4 type 40 Watt Halogen** appliance bulb. Please note: do not allow your fingers to touch the new bulb when replacing. This will shorten the life of the new bulb. Use a paper towel to cover the new bulb when installing.
4. Replace glass shield over bulb.
5. Turn power back on again at the main source (or plug the appliance back in).
6. The clock will then need to be reset.

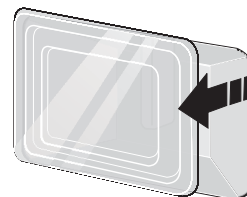

Lift backside  
of glass shield  
and remove it.

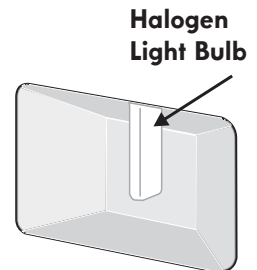



# Before You Call





## Solutions to Common Problems

### OVEN BAKING

For best cooking results, heat the oven before baking cookies, breads, cakes, pies or pastries, etc. There is no need to preheat the oven for roasting meat or baking casseroles.

The cooking times and temperatures needed to bake a product may vary slightly from your previously owned appliance.

### Baking Problems and Solutions Chart

BAKING PROBLEMS	CAUSES	CORRECTIONS
<p><b>Cookies and biscuits burn on the bottom.</b></p> 	<ul style="list-style-type: none"> <li>• Cookies and biscuits put into the oven before the preheating time is completed.</li> <li>• Oven rack overcrowded.</li> <li>• Dark pan absorbs heat too fast.</li> </ul>	<ul style="list-style-type: none"> <li>• Allow oven to preheat to the selected temperature before placing food in oven.</li> <li>• Choose pan sizes that will permit 5.1cm to 10.2cm (2" to 4") of air space on all sides when placed in the oven.</li> <li>• Use a medium-weight aluminum baking sheet.</li> </ul>
<p><b>Cakes too dark on top or bottom.</b></p> 	<ul style="list-style-type: none"> <li>• Cakes put into the oven before preheating time is completed.</li> <li>• Rack position too high or low.</li> <li>• Oven too hot.</li> </ul>	<ul style="list-style-type: none"> <li>• Allow oven to preheat to the selected temperature before placing food in the oven.</li> <li>• Use proper rack position for baking needs.</li> <li>• Set oven temperature 25°F/12°C lower than recommended.</li> </ul>
<p><b>Cakes not done in the center.</b></p> 	<ul style="list-style-type: none"> <li>• Oven too hot.</li> <li>• Incorrect pan size.</li> <li>• Pan not centered in oven.</li> </ul>	<ul style="list-style-type: none"> <li>• Set oven temperature 25°F/12°C lower than recommended.</li> <li>• Use pan size suggested in recipe.</li> <li>• Use proper rack position and place pan so there is 5.1cm to 10.2cm (2" to 4") of space on all sides of pan.</li> </ul>
<p><b>Cakes not level.</b></p> 	<ul style="list-style-type: none"> <li>• Range not level.</li> <li>• Pan too close to oven wall or rack overcrowded.</li> <li>• Pan warped.</li> </ul>	<ul style="list-style-type: none"> <li>• Place a marked glass measuring cup filled with water on the center of the oven rack. If the water level is uneven, refer to the installation instructions for leveling the range.</li> <li>• Be sure to allow 5.1cm to 10.2cm (2" to 4") of clearance on all sides of each pan in the oven.</li> <li>• Do not use pans that are dented or warped.</li> </ul>
<p><b>Foods not done when cooking time is up.</b></p> 	<ul style="list-style-type: none"> <li>• Oven too cool.</li> <li>• Oven overcrowded.</li> <li>• Oven door opened too frequently.</li> </ul>	<ul style="list-style-type: none"> <li>• Set oven temperature 25°F/12°C higher than suggested and bake for the recommended time.</li> <li>• Be sure to remove all pans from the oven except the ones to be used for baking.</li> <li>• Open oven door only after shortest recommended baking time.</li> </ul>

## Before You Call (continued)

### Solutions to Common Problems

**Before you call for service**, review this list. It may save you time and expense. The list includes common occurrences that are not the result of defective workmanship or materials in this appliance.

OCCURRENCE	POSSIBLE CAUSE/SOLUTION
<b>Microwave Oven</b>	
<b>Control pads for Sensor Cooking, One-Touch Cooking, and Defrost will not operate.</b>	<ul style="list-style-type: none"> <li>The oven door was opened and closed without initiating a cooking cycle within three minutes. Touch <b>Stop</b> to resume normal pad operation.</li> </ul>
<b>Microwave oven light does not come on. Cooling fan does not work. Turntable does not rotate. Water in a cup in microwave does not warm.</b>	<ul style="list-style-type: none"> <li>If one of those situation appear please check the electrical outlet, fuse and/or circuit breaker. If they are functioning properly, contact Sears Part &amp; Repair. A microwave oven should never be serviced by a “do-it-yourself” repair person.</li> </ul>
<b>My popcorn is not popping completely when using my microwave</b>	<ul style="list-style-type: none"> <li>Always use the popcorn/bacon tray provided with the unit to cook popcorn. Do not place microwave popcorn directly on the metal turntable as metal on metal may produce sparking.</li> </ul>
<b>A fan always comes on when I use my microwave oven</b>	<ul style="list-style-type: none"> <li>This is normal. This appliance is equipped with a blower which keeps all internal components at a cool temperature. The blower may keep running even if the oven has been turned off, until the components have cooled down.</li> </ul>
<b>Lower Oven</b>	
<b>Faulty Installation</b>	<ul style="list-style-type: none"> <li>Place oven rack in center of oven. Place a level on the oven rack. Contact installing agent if rack and cabinet cutout flooring are not level.</li> <li>Kitchen cabinet misalignment may make oven appear to be not level. Be sure cabinets are square and level. Contact cabinet maker to correct problem.</li> </ul>
<b>Entire appliance does not operate</b>	<ul style="list-style-type: none"> <li>The time of day is not set. The time of day <b>must</b> first be set in order to operate the oven. See “Setting clock at power up” in the <b>Getting Started</b> section.</li> <li>Be sure electrical cord is securely connected into the electrical junction box.</li> <li>Cord/plug is not installed and/or connected. Cord is not supplied with oven. Contact your dealer, installing agent or authorized servicer.</li> <li>Service wiring is not complete. Contact your dealer, installing agent or authorized service agent.</li> <li>Electrical power outage. Check house lights to be sure. Call your local electric company for service.</li> <li>Short in cord/plug. Replace cord/plug.</li> <li>Controls are not set properly. See instructions to set the controls.</li> <li>House fuse has blown or circuit breaker has tripped immediately following installation.</li> <li>House fuse may not be fully engaged. Check fuse and screw or engage circuit breaker securely.</li> </ul>
<b>Oven does not operate</b>	<ul style="list-style-type: none"> <li>Be sure the oven controls are set properly for the desired cooking feature. See <b>Lower Oven Operating Instructions</b> in this Use &amp; Care Guide or read the instructions “<b>Entire appliance does not operate</b>” in this checklist.</li> </ul>
<b>Oven light does not work</b>	<ul style="list-style-type: none"> <li>Replace or tighten bulb. See <b>Changing Lower Oven Light</b> section in this Use &amp; Care Guide.</li> <li>Electrical power outage. Check house lights to be sure. Call your local electric company for service.</li> </ul>

## Before You Call (continued)

### Solutions to Common Problems

OCCURRENCE	POSSIBLE CAUSE/SOLUTION
Self-cleaning cycle does not work	<ul style="list-style-type: none"><li>• Make sure the oven door is closed.</li><li>• Make sure you have removed the oven racks and the oven rack supports from the oven.</li><li>• Controls not set properly. Follow instructions under “Dual Convection Lower Oven Self-Cleaning Cycle”.</li></ul>
Flames inside oven or smoking from oven vent	<ul style="list-style-type: none"><li>• Excessive spillovers in oven. For example this will happen for pie spillovers or large amounts of grease left on the oven bottom. Wipe up excessive spillovers before starting oven. If flames or excessive smoke are present see “Broil” in the <b>Lower Oven Operating Instructions</b> section.</li></ul>
<b>Lower Oven</b>	
Soil not completely removed after self-cleaning cycle is completed	<ul style="list-style-type: none"><li>• Failure to clean bottom, from top of oven, frame of oven or door area outside oven seal. These areas are not in the self-cleaning area, but get hot enough to burn on residue. Clean these areas before the self-cleaning cycle is started. Burned on residue can be cleaned with a stiff nylon brush and water or a nylon scrubber. Be careful not to damage the oven gasket.</li><li>• Excessive spillovers in oven. Set the self-clean cycle for longer cleaning time.</li></ul>
Oven smokes excessively during broiling	<ul style="list-style-type: none"><li>• Control not set properly. Follow broiling instructions under <b>Lower Oven Operating Instructions</b>.</li><li>• Meat too close to the broil element. Reposition the broil rack to provide proper clearance between the meat &amp; the element. Preheat the broil element for searing.</li><li>• Meat not properly prepared. Remove excess fat from meat. Cut remaining fatty edges to prevent curling, but do not cut into lean.</li><li>• Insert on broiler pan wrong side up &amp; grease not draining. Always place grid on the broiler pan with ribs up &amp; slots down to allow grease to drip into pan (some models).</li><li>• Grease has built up on oven surfaces. Regular cleaning is necessary when broiling frequently. Old grease or food spatters cause excessive smoking.</li></ul>
Oven control panel beeps & displays any F code error (for example F10)	<ul style="list-style-type: none"><li>• Oven control has detected a fault or error condition. Press <b>STOP</b> to clear the display &amp; stop beeping. Try the bake or broil feature again. If the F code error repeats, remove power supply to appliance, wait 5 minutes and then repower the appliance and set clock for the time of day. Try the bake or broil feature again. If the fault recurs, record fault and call for service.</li></ul>
Poor baking results	<ul style="list-style-type: none"><li>• Many factors affect baking results. Make sure the proper oven rack position is used. Center food in the oven and space pans to allow air to circulate. Allow the oven to preheat to the set temperature before placing food in the oven. Try adjusting the recipe’s recommended temperature or baking time. If you feel the oven is too hot or cool, see “Adjusting Oven Temperature” in the <b>User Preferences</b> section of this Use &amp; Care Guide.</li></ul>

## Notes

# PROTECTION AGREEMENTS

## Master Protection Agreements

*Congratulations on making a smart purchase. Your new Kenmore® product is designed and manufactured for years of dependable operation. But like all products, it may require preventive maintenance or repair from time to time. That's when having a Master Protection Agreement can save you money and aggravation.*

The Master Protection Agreement also helps extend the life of your new product. Here's what the Agreement\* includes:

- ☑ **Parts and labor** needed to help keep products operating properly **under normal use**, not just defects. Our coverage goes **well beyond the product warranty**. No deductibles, no functional failure excluded from coverage – **real protection**.
- ☑ **Expert service** by a force of more than **10,000 authorized Sears service technicians**, which means someone you can trust will be working on your product.
- ☑ **Unlimited service calls and nationwide service**, as often as you want us, whenever you want us.
- ☑ **«No-lemon» guarantee** – replacement of your covered product if four or more product failures occur within twelve months.
- ☑ **Product replacement** if your covered product can't be fixed.
- ☑ **Annual Preventive Maintenance Check** at your request – no extra charge.
- ☑ **Fast help by phone** – we call it **Rapid Resolution** – phone support from a Sears representative on all products. Think of us as a «talking owner's manual».
- ☑ **Power surge protection** against electrical damage due to power fluctuations.
- ☑ **\$250 Food Loss Protection** annually for any food spoilage that is the result of mechanical failure of any covered refrigerator or freezer.
- ☑ **Rental reimbursement** if repair of your covered product takes longer than promised.
- ☑ **10% discount** off the regular price of any non-covered repair service and related installed parts.

Once you purchase the Agreement, a simple phone call is all that it takes for you to schedule service. You can call anytime day or night, or schedule a service appointment online.

The Master Protection Agreement is a risk free purchase. If you cancel for any reason during the product warranty period, we will provide a full refund. Or, a prorated refund anytime after the product warranty period expires. Purchase your Master Protection Agreement today!

**Some limitations and exclusions apply. For prices and additional information in the U.S.A. call 1-800-827-6655.**

**\* Coverage in Canada varies on some items. For full details call Sears Canada at 1-800-361-6665.**

## Sears Installation Service

*For Sears professional installation of home appliances, garage door openers, water heaters, and other major home items, in the U.S.A. or Canada call **1-800-4-MY-HOME**®.*

## Acuerdos maestros de protección

*Enhorabuena por haber hecho una compra inteligente. Su nuevo producto Kenmore® está diseñado y fabricado para brindarle años de funcionamiento fiable. Pero, como cualquier producto, puede necesitar mantenimiento preventivo o reparaciones periódicas. Es por eso que tener un Acuerdo maestro de protección podría ahorrarle dinero y molestias.*

El Acuerdo maestro de protección también sirve para prolongar la durabilidad de su nuevo producto. El acuerdo\* incluye lo siguiente:

- ☑ **Piezas y mano de obra** necesarias para contribuir a mantener el funcionamiento adecuado de los productos **utilizados en condiciones normales de uso**, no sólo en caso de defectos de los productos. Nuestra cobertura va **mucho más allá que la garantía del producto**. No se aplican deducibles ni exclusiones por fallas del funcionamiento: es decir, **verdadera protección**.
- ☑ **Servicio técnico por expertos** (más de **10000 técnicos autorizados de Sears**), lo cual significa que quien repare o realice el mantenimiento de su producto será un profesional de confianza.
- ☑ **Servicio técnico a escala nacional y número ilimitado de llamadas de solicitud de servicio técnico**: se puede poner en contacto con nosotros cuantas veces lo desee y cuando lo desee.
- ☑ **Garantía «sin sorpresas»**: se reemplaza el producto cubierto por el acuerdo si ocurren cuatro o más fallas del producto en un periodo de 12 meses.
- ☑ **Reemplazo del producto**: en caso de que no se pueda reparar el producto cubierto por el acuerdo.
- ☑ **Revisión anual preventiva de mantenimiento del producto**: puede solicitarla en cualquier momento, sin costo alguno.
- ☑ **Rápida asistencia telefónica**, la cual denominamos **Solución rápida**: es decir, asistencia telefónica a través de cualquiera de nuestros representantes de Sears, sobre cualquiera de nuestros productos. Piense en nosotros como en un «manual parlante del usuario».
- ☑ **Protección contra fallas eléctricas**, contra daños debidos a fluctuaciones de la corriente eléctrica.
- ☑ **\$250 al año para cubrir cualquier posible deterioro de alimentos** que haya tenido que desechar debido a una falla mecánica de cualquiera de nuestros refrigeradores o congeladores cubiertos por este acuerdo.
- ☑ **Devolución de gastos de alquiler de electrodomésticos** si la reparación de su producto asegurado toma más que el tiempo prometido.
- ☑ **10% de descuento** aplicable tanto a los costos del servicio de reparación, como de las piezas instaladas relacionadas que no hayan quedado cubiertos por este acuerdo.

Una vez que haya realizado el pago de este acuerdo, bastará una simple llamada telefónica para concertar una visita de servicio. Puede llamar a cualquier hora del día o de la noche, o bien concertar una visita de servicio por Internet.

La adquisición del Acuerdo maestro de protección es una inversión exenta de riesgos. Si por cualquier motivo decide cancelar dicho acuerdo durante el periodo de garantía del producto, le haremos un reintegro total del valor. O bien un importe proporcional si cancela el acuerdo en cualquier otro momento posterior al vencimiento del periodo de garantía del producto. ¡Adquiera hoy mismo su Acuerdo maestro de protección!

**Algunas limitaciones y exclusiones podrían aplicarse. Para solicitar precios e información adicional, llame al 1-800-827-6655 (en los EE.UU.).**

**\* La cobertura en Canadá varía en el caso de algunos artículos. Para obtener detalles completos al respecto, llame al 1-800-361-6665 de Sears de Canadá.**

## Servicio de instalación de Sears

*Para solicitar la instalación por profesionales de Sears de electrodomésticos, abridores de puertas de garaje, calentadores de agua y otros artículos de uso prioritario en el hogar, llame al **1-800-4-MY-HOME** en los EE.UU. o Canadá.*

# Get it fixed, at your home or ours!

## Your Home

For troubleshooting, product manuals and expert advice:



[www.managemylife.com](http://www.managemylife.com)

---

For repair – **in your home** – of **all** major brand appliances, lawn and garden equipment, or heating and cooling systems, **no matter who made it, no matter who sold it!**

For the replacement parts, accessories and owner's manuals that you need to do-it-yourself.

For Sears professional installation of home appliances and items like garage door openers and water heaters.

**1-800-4-MY-HOME<sup>®</sup>** (1-800-469-4663)

Call anytime, day or night (U.S.A. and Canada)

[www.sears.com](http://www.sears.com)      [www.sears.ca](http://www.sears.ca)

---

## Our Home

For repair of carry-in items like vacuums, lawn equipment, and electronics, call anytime for the location of your nearest

**Sears Parts & Repair Service Center**

**1-800-488-1222** (U.S.A.)

[www.sears.com](http://www.sears.com)

**1-800-469-4663** (Canada)

[www.sears.ca](http://www.sears.ca)

---

To purchase a protection agreement on a product serviced by Sears:

**1-800-827-6655** (U.S.A.)

**1-800-361-6665** (Canada)

---

Para pedir servicio de reparación a domicilio, y para ordenar piezas:

**1-888-SU-HOGAR<sup>®</sup>**

(1-888-784-6427)

[www.sears.com](http://www.sears.com)

Au Canada pour service en français:

**1-800-LE-FOYER<sup>MC</sup>**

(1-800-533-6937)

[www.sears.ca](http://www.sears.ca)

The Sears logo, featuring the word "Sears" in a large, bold, serif font with a stylized 'S'.

® Registered Trademark / <sup>TM</sup> Trademark of KCD IP, LLC in the United States, or Sears Brands, LLC in other countries

® Marca Registrada / <sup>TM</sup> Marca de Fábrica de KCD IP, LLC en Estados Unidos, o Sears Brands, LLC in otros países

<sup>MC</sup> Marque de commerce / <sup>MD</sup> Marque déposée de Sears Brands, LLC

## Free Manuals Download Website

<http://myh66.com>

<http://usermanuals.us>

<http://www.somanuals.com>

<http://www.4manuals.cc>

<http://www.manual-lib.com>

<http://www.404manual.com>

<http://www.luxmanual.com>

<http://aubethermostatmanual.com>

Golf course search by state

<http://golfingnear.com>

Email search by domain

<http://emailbydomain.com>

Auto manuals search

<http://auto.somanuals.com>

TV manuals search

<http://tv.somanuals.com>