

Sears

USE & CARE
MANUAL

STOCK NO.
85941

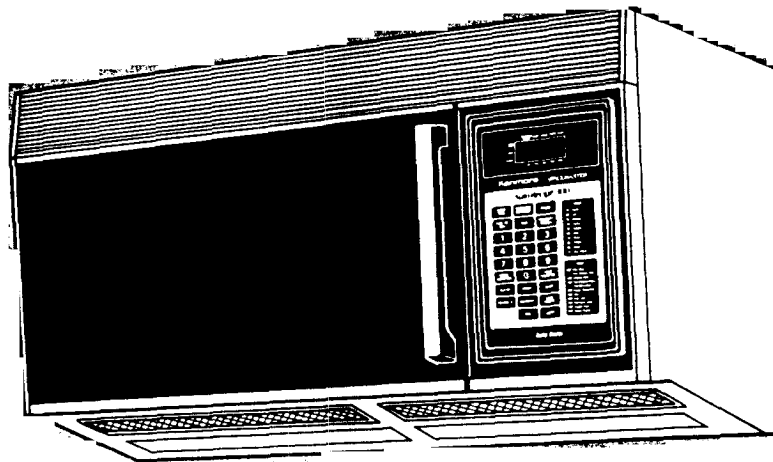

KNOW YOUR UNIT

Read this booklet so you will be able to enjoy all the features in your Kenmore Microwave Oven.

Record in space provided below the Model No. and the Serial No. found on the label on the left side of the control panel.

Model No. _____

Serial No. _____

Retain this information for future reference.

Kenmore
MICROWAVE OVEN
Use and Care

YOUR SAFETY FIRST

The Sears Kenmore Microwave Oven, though simple to use, is not a toy. Respect it as an electric cooking appliance. Become familiar with microwave energy, its uses and limitations.

PRECAUTIONS TO AVOID POSSIBLE EXPOSURE TO EXCESSIVE MICROWAVE ENERGY

- (a) DO NOT ATTEMPT to operate this oven with the door open since open-door operation can result in harmful exposure to microwave energy. It is important not to defeat or tamper with the safety interlocks.
- (b) DO NOT PLACE any object between the oven front face and the door or allow soil or cleaner residue to accumulate on sealing surfaces.
- (c) DO NOT OPERATE the oven if it is damaged. It is particularly important that the oven door closes properly and that there is no damage to the:
 - (1) DOOR (bent)
 - (2) HINGES AND LATCHES (broken or loosened)
 - (3) DOOR SEALS AND SEALING SURFACES
- (d) THE OVEN SHOULD NOT BE ADJUSTED OR REPAIRED BY ANYONE EXCEPT PROPERLY QUALIFIED SERVICE PERSONNEL.

IMPORTANT—FOR PROPER AND SAFE USE OF YOUR OVEN

- The oven must be level.
- The glass tray must be in the oven during cooking.
- The metal rack must be removed from the oven when the rack is not used for cooking.
- The oven should be thoroughly checked by a trained service technician, should it be dropped or damaged, before it is operated again.
- The electrical power cord must be kept dry and must not be pinched or crushed in any way.
- The oven has several built-in safety switches to make sure the power remains off when the door is open. DO NOT try to defeat these switches.

DON'TS

- DO NOT attempt to operate this oven with the door open.
- DO NOT run the oven empty without food in it.
- DO NOT operate the oven empty with the temperature probe plugged in.
- DO NOT run the oven empty with the Metal Rack in it.
- DO NOT use browning dishes on Metal Rack.
- DO NOT use foil or metal containers on the Metal Rack.
- DO NOT allow the temperature probe sensor to touch the sides, bottom or door of the oven when it is in use.
- DO NOT use the temperature probe in a regular oven.
- DO NOT store burnable material, such as food, in your microwave oven.
- DO NOT use this microwave oven for commercial purposes. This Sears Kenmore Microwave Oven is made for household use only.

SAFETY CERTIFICATION

The Sears Kenmore Microwave Oven is designed and thoroughly tested to meet exacting safety standards. It meets UL and FCC requirements and complies with safety performance standards of the U.S. Department of Health and Human Services.

TABLE OF CONTENTS

General Instructions

| | |
|----------------------------------------|---|
| ■ Location of Model Number Label | 4 |
| ■ Installation | 5 |
| ■ Setting “Time of Day” | 5 |
| ■ Names of Oven Parts | 6 |
| ■ Oven Control Panel | 7 |

Use Instructions

| | |
|----------------------------------------|----|
| ■ Use Instructions—Cooking Guide | 8 |
| ■ Easy Use Chart | 9 |
| ■ Recall and Change of Settings | 10 |
| ■ Pause between Stages | 10 |
| ■ Regular Timer | 10 |

Detailed Directions

| | |
|--------------------------------------------------------------------------------|------------|
| ■ “HI-Power” Cooking | 11 |
| ■ Cooking Guide for “Multi-Power” Settings | 12 |
| ■ “Multi-Power” Cooking | 13 |
| ■ “Temperature Controlled” Cooking | 14–16 |
| ■ Temperature Controlled “HI-Power” Cooking and Automatic “Hold Warm” | 17 |
| ■ Temperature Controlled “Multi-Power” Cooking and Automatic “Hold Warm” | 18 |
| ■ Two, Three or Four-Stage Cooking | 19–20 |
| ■ Delay-Start Cooking | 21 |
| ■ Whole Meal Cooking | 22 |
| ■ Programmed Defrost by Time | 23–27 |
| ■ Programmed Defrost by Temperature | 28 |
| ■ Preset Recipe Cooking | 29–31 |
| • Auto Recipe 300 | 29–30 |
| • Use of Quantity key | 31 |
| ■ Programming New Recipes | 31 |
| Utensils | 32 |
| Care and Cleaning | 33–35 |
| Questions and Answers | 36–37 |
| Before Calling for Service | 38 |
| Sears Service | 39 |
| Sears Warranty | Back Cover |

**SEARS KENMORE MICROWAVE OVEN
"USE AND CARE MANUAL"—
MICROWAVE OVEN USE INSTRUCTIONS**

Enjoy a new cooking experience from Sears. Please read this booklet. It takes only a few minutes—time well spent to learn how to use all of the features.

Advice on the use and care of Sears appliances is always available at your nearest Sears store. When seeking information, be sure you have the complete model number which is located on the plastic label. See below for its location.

MODEL NUMBER

To make a request for service, information or replacement of parts, Sears will require the complete model number of your microwave oven. The number is on the inner left side of the control panel. (You must open the door to see the number). The model number is also located on the back of the cabinet.

The number will look like this: 564.8000000.

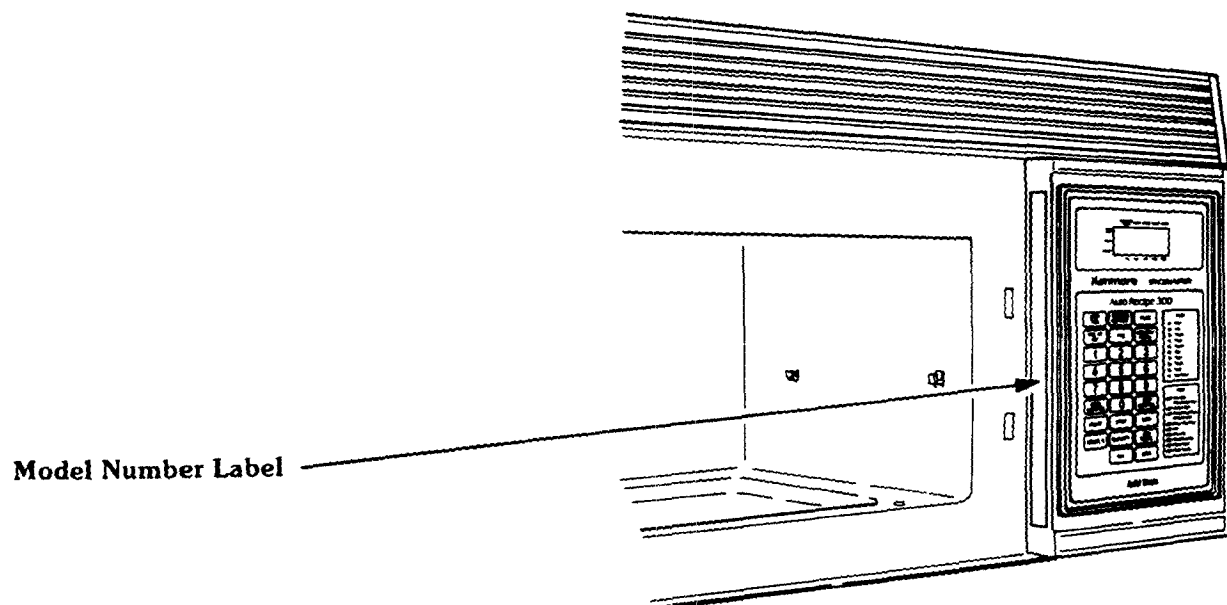

INSTALLATION

Complete Installation Instructions are included in the separate instruction manual. If you have any question on installation, please contact your Sears sales person or local Sears Service Center.

A mounting space of 33" or more from the surface of cooktop to the bottom of kitchen top cabinet, and at least 30" wide is required to mount the oven.

When the Oven is first turned on after installation, the Display Window will flash until you touch CLEAR.

Note: If your oven does not operate properly, unplug the oven from the 120-volt household outlet and then plug it back in.

SETTING TIME OF DAY

- Touch CLEAR
- Touch TIME OF DAY
- Touch numbers for correct time
- Touch TIME OF DAY

DIMENSIONS

| | |
|---------------|-----------------|
| Height | 19-3/8" |
| Width | 29-7/8" |
| Depth | 19-1/4" |
| Weight | 106 lbs. |

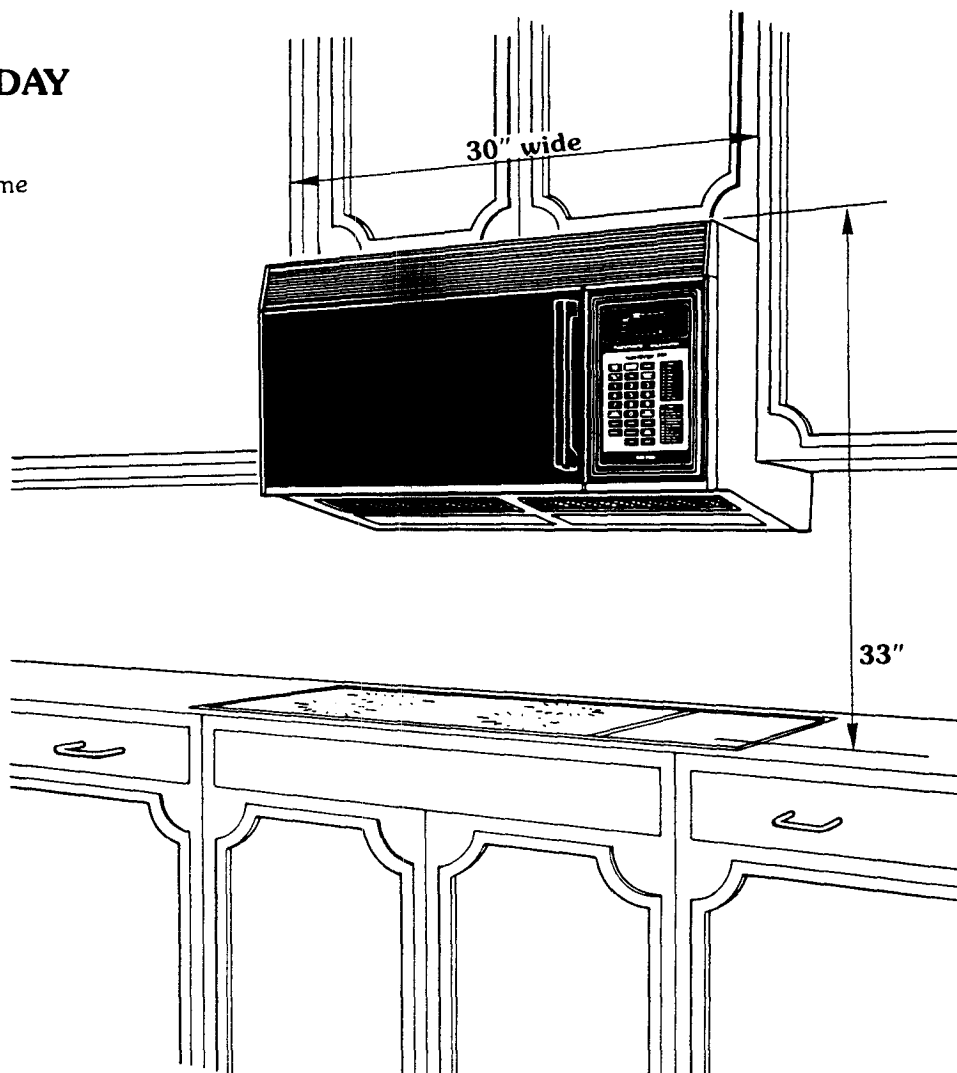

NAMES OF OVEN PARTS

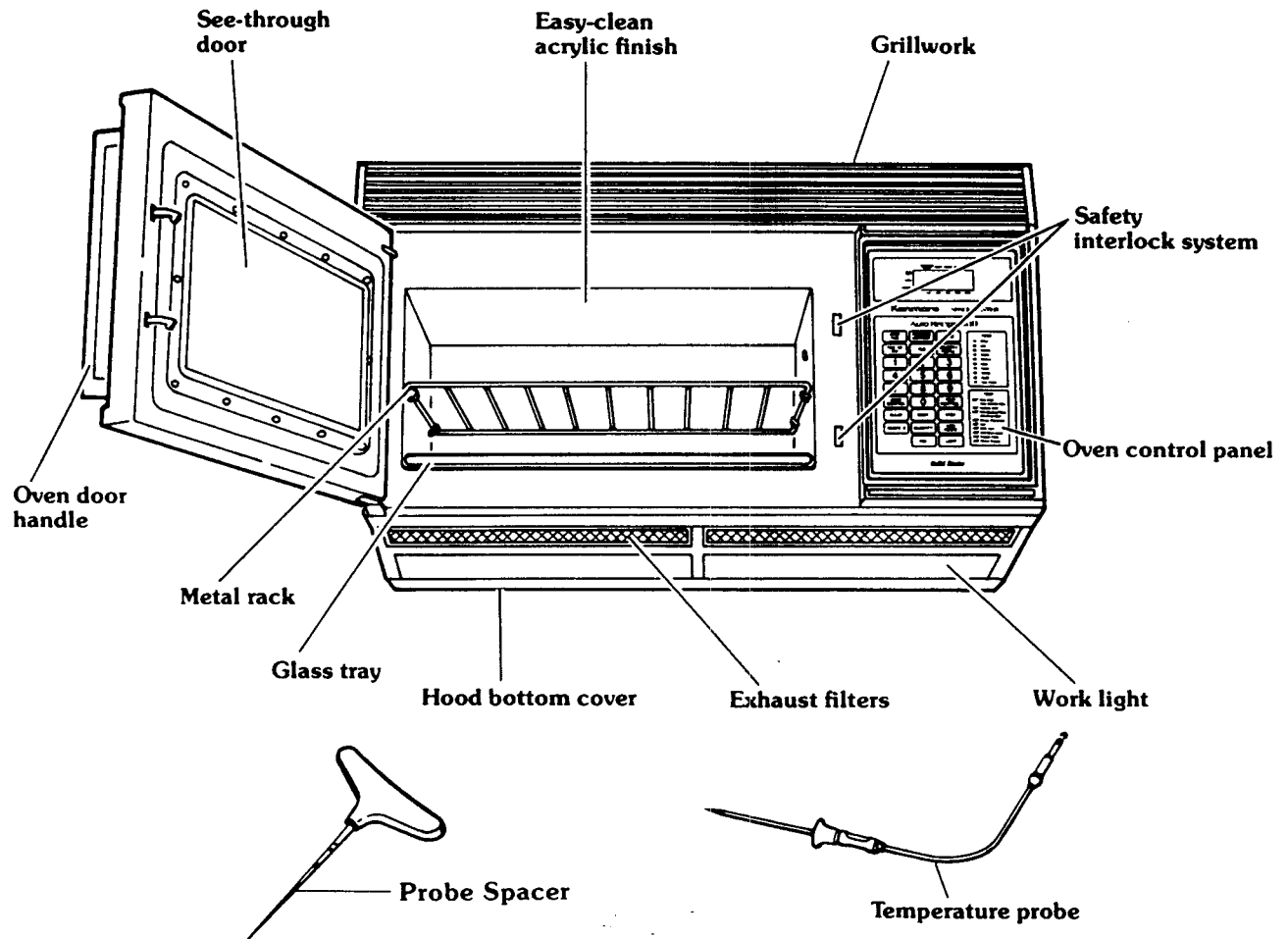

Please read "Requirements For Installation" section in Installation Manual before you remove the rest of contents from carton.

Your Oven will come with the following items.

| | |
|-------------------------------------------|--------|
| Glass Tray | 1 each |
| Metal Rack | 1 each |
| Temperature Probe | 1 each |
| Probe Spacer | 1 each |
| Cookbook | 1 each |
| Use and Care Manual | 1 each |
| Easy Use Chart Card | 1 each |
| Installation Instruction Manual | 1 each |
| Top Cabinet Template | 1 each |
| Wall Template | 1 each |
| Hardware Package | 1 each |
| Damper/Duct Connector | 1 each |

Do not use this Sears Kenmore Microwave Oven for commercial purposes. This microwave oven is made for household use only.

OVEN CONTROL PANEL

Stage Lights—When cooking stages are set, lights will go on indicating the stage in which your oven is cooking.

Indicator Lights—Time, Cook, Temp, Recipe, Delay-start and Programmed Defrost lights indicate which cooking operation is being used.

Quantity Light—When preset cooking is set light indicates that multiplication can be used in the recipe.

Programmed Defrost—Used in setting programmed defrost.

Stop Time—Used in setting a Delay-Start cooking. Cooking can be finished at the preset stop time.

Time of Day—Used in setting Time of Day.

Time—Used in setting Cooking Time.

Numbers—Used to enter the:

- Time of day.
- Delay-start time.
- Cooking times.
- Cooking powers.
- Cooking temperatures.

Cook Control—Used to select cooking power levels.

Clear—Clears all entries except TIME OF DAY. Once cooking has begun, however, CLEAR will function only after STOP has been touched.

Recipe*—Used in preset recipe cooking.

Start—Starts the oven.

Quantity—Used in multiplying base quantity of preset recipes.

Fan Control—Exhausts the air by hood fan.

Work Light—Lights up cooktop or countertop.

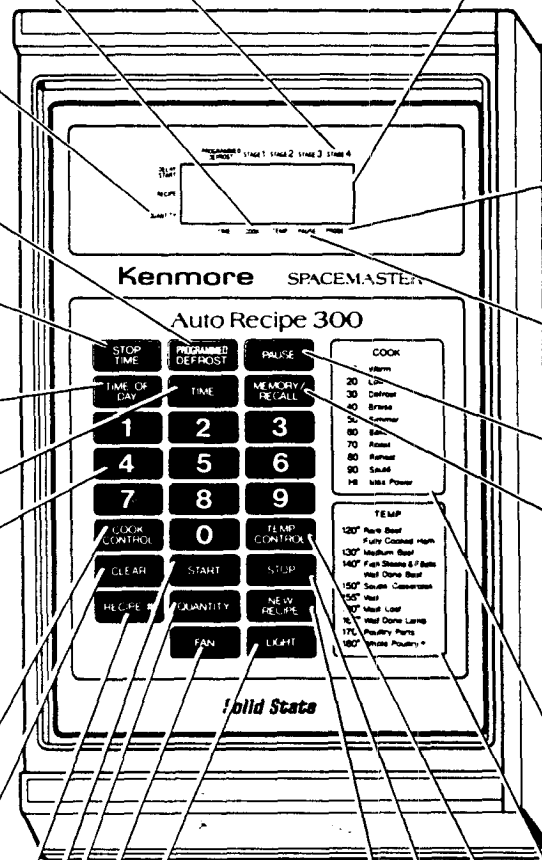

Display Window—Used to show:

- Time of day.
- Cooking time.
- Cooking power level.
- Cooking temperature.
- Hold.
- Pause (PAUS).
- Defrost (dEF).
- Recipe #.

It also functions as countdown timer or temperature indicator when cooking.

Probe Light—Flashes to warn that temperature probe is not plugged into the socket inside the oven for "Temperature Control" cooking.

Pause Light—Shows oven has been set to pause between the cooking stages.

Pause—Used to stop oven between cooking stages.

Memory/Recall—For two, three, four-stage cooking MEMORY/RECALL is used in setting:

- Cooking time.
- Power level.
- Temperature.

Also, it is used to recall each memory stage in a multiple-stage cooking program.

Cook Guide—Cooking guide which lists the types of cooking that most often occur at these cooking power levels.

Temp Guide—Temperature guide which lists the examples of food that are best cooked at these temperatures.

Temp Control—Used in setting the desired food temperature and the programmed defrost by temperature. "Temperature Control" cooking can be done only when the temperature probe is plugged into the socket inside the oven.

New Recipe—Used in programming new recipes.

Stop—Stops the oven.

NOTE: A "beep tone" sounds when a "pad" on the control panel is touched, to indicate a setting has been entered.

USE INSTRUCTIONS—COOKING GUIDE

“HI-POWER” COOKING

“HI” gives the highest power cooking possible with your microwave oven. It is the recommended setting for cooking foods with high moisture content or for cooking foods that need fast cooking to maintain their natural flavor and texture. Your *Kenmore Microwave Cooking* cookbook will tell you which foods are cooked best using the highest microwave cooking power (“HI”). For detailed directions on “HI” (maximum power) cooking, see Page 11.

“MULTI-POWER” COOKING

Many foods need slower cooking (at less than full power) in order to give the best results. In addition to “HI”, there are ninety-nine “multi-power” settings. Detailed directions for “multi-power” cooking are on Page 13.

TEMPERATURE CONTROLLED “HI-POWER” COOKING

“HI-Power” with TEMP CONTROL allows you to cook food to a preset temperature using maximum speed. Follow the directions on Page 17 and you will be able to preset the temperature you desire with the aid of the “Temperature Control” cooking guide.

TEMPERATURE CONTROLLED “MULTI-POWER” COOKING

“Multi-Power” with TEMP CONTROL allows you to cook more sensitive foods to a preset temperature by using slower microwave cooking speeds. See Page 18 for detailed directions.

AUTOMATIC “HOLD WARM”

After reaching the set temperature, the oven switches into “Hold Warm” to keep the food warm.

“Hold” will show in the display window and will continue to show for up to sixty minutes or until the door has been opened or STOP has been touched. See Pages 17 and 18.

FOUR-STAGE COOKING

Some recipes need more than one cooking stage. Many foods will cook better when cooked for a period of time at one power setting and then cooked for another period of time at a different power setting. With a cake, for example, the cookbook may recommend cooking at the “60 (Bake)” setting, followed by a period of cooking time at the “HI” setting. “Bake” allows the cake to rise gently, and then “HI” finishes the cooking cycle. You can preset up to four stages at the beginning, start the oven, and then the oven will change automatically into the second stage at the preset time. “Two, Three or Four-Stage Cooking” with both TIME and TEMP CONTROL can also be set. For detailed directions on “Two, Three or Four-Stage Cooking”, see Pages 19 and 20.

DELAY START COOKING

For those times when you must be away from the kitchen, but want dinner ready when you return, cooking can be started and finished at the time of day selected. See page 21 for detailed directions.

WHOLE MEAL COOKING

The Metal Rack increases the oven cooking space. To cook two or more different foods at one time, choose their proper places inside the oven by following the cookbook directions. See page 22.

PROGRAMMED DEFROST

Power level will automatically change for proper thawing of dense food items. See pages 23 thru 28 for detailed directions.

PRESET RECIPE COOKING — “Auto Recipe 300” and “3 Customer Programmable Recipes”

300 Recipes were developed by our cooking experts and have been preset into this oven for automatic cooking.

To use “AUTO RECIPE 300” cooking, touch RECIPE #, the numbers corresponding with the desired Recipe(s) shown in the cook-book and then START.

See pages 29 thru 31 of this Manual, as well as your Kenmore Microwave Cookbook for detailed directions.

In addition to AUTO RECIPE 300, 3 more recipes (Recipe #301—303) can be programmed by yourself for preset recipe cooking. See page 31 of this manual for detailed directions.

AUTOMATIC HOOD FAN CONTROL

The two-speed fan can be turned on by touching the FAN key. It is also automatically run at high speed by a heat sensing device. The sensing device detects overheating conditions from the heating surface below and turns on the fan to prevent damage to the oven. Once it is run by the sensing device, it can not be defeated by the FAN key. It continuously runs until the temperature of the Oven drops to a safe level.

EASY USE CHART

Your new solid state control system allows you to use your microwave oven in many ways.

| TIME OF DAY | "HI-POWER" COOKING | "MULTI-POWER" COOKING |
|----------------------------------------------------------------------------------------------------------------------------------------------------------------------------------------------------------------------------------------------------------------------------------------------------------------------------------------------------------------------------------------------------------------------------------------------------------------------------------------------------------------------------------------------------------------------|---------------------------------------------------------------------------------------------------------------------------------------------------------------------------------------------------------------------------------------------------------------------------------------------------------------------------------------------------------------------------------------------|--------------------------------------------------------------------------------------------------------------------------------------------------------------------------------------------------------------------------------------------------------------------------------------------------------------------------------------------------------------------------------------------------------------------------------------------------------------------------------------------------------------------------------------------------------------------------------------------------------------------------------------|
| <p>To set:</p> <ol style="list-style-type: none"> 1. Touch CLEAR. 2. Touch TIME OF DAY. 3. Touch numbers for correct time of day. 4. Touch TIME OF DAY.* <p>*This "locks" in the time and starts the clock running.</p> | <p>To set:</p> <ol style="list-style-type: none"> 1. Touch CLEAR. 2. Touch TIME. 3. Touch numbers for desired cooking time. 4. Touch START. <p>(See Page 11 for more detailed instructions.)</p> | <p>To set:</p> <ol style="list-style-type: none"> 1. Touch CLEAR. 2. Touch TIME. 3. Touch numbers for desired cooking time. 4. Touch COOK CONTROL. 5. Touch numbers for desired cooking power level. 6. Touch START. <p>(See Page 13 for more detailed instructions.)</p> |
| <p>TEMPERATURE CONTROLLED "HI-POWER" COOKING</p> | <p>TEMPERATURE CONTROLLED "MULTI-POWER" COOKING</p> | <p>FOUR-STAGE COOKING</p> |
| <p>To set:</p> <ol style="list-style-type: none"> 1. Plug in temperature probe. 2. Touch CLEAR. 3. Touch TEMP CONTROL. 4. Touch numbers for desired cooking temperature. 5. Touch START. <p>(See Page 17 for more detailed instructions.)</p> | <p>To set:</p> <ol style="list-style-type: none"> 1. Plug in temperature probe. 2. Touch CLEAR. 3. Touch TEMP CONTROL. 4. Touch numbers for desired cooking temperature. 5. Touch COOK CONTROL. 6. Touch numbers for desired cooking power level. 7. Touch START. <p>(See Page 18 for more detailed instructions.)</p> | <p>To set:</p> <ol style="list-style-type: none"> 1. Touch CLEAR. 2. Touch TIME or TEMP CONTROL. 3. Touch numbers for cooking time or temperature. 4. Touch COOK CONTROL. 5. Touch numbers for cooking power level. 6. Touch MEMORY/RECALL or PAUSE and repeat steps 2-5 to set 2nd cooking stage. 7. Touch MEMORY/RECALL or PAUSE and repeat steps 2-5 to set 3rd cooking stage. 8. Touch MEMORY/RECALL or PAUSE and repeat steps 2-5 to set 4th cooking stage. 9. Touch START. <p>(See Pages 19 and 20 for more detailed instructions.)</p> |
| <p>DELAY START COOKING</p> | <p>PROGRAMMED DEFROST BY TEMPERATURE</p> | <p>PROGRAMMING NEW RECIPES</p> |
| <p>To Set:</p> <ol style="list-style-type: none"> 1. Touch CLEAR. 2. Touch STOP TIME. 3. Touch Numbers for time of day to finish cooking. 4. Touch TIME. 5. Touch numbers for cooking time. 6. Touch COOK CONTROL. 7. Touch numbers for cooking power level. 8. Touch START. <p>* Three-Stage cooking can be used with Delay Start. After step 3 above, follow instructions for Four-Stage cooking beginning with step 2.</p> <p>(See Page 21 for more detailed instructions.)</p> | <p>To set:</p> <ol style="list-style-type: none"> 1. Drill food by using the Probe Spacer furnished with the oven. 2. Place Temperature Probe into hole and plug into socket. 3. Touch CLEAR. 4. Touch PROGRAMMED DEFROST. 5. Touch TEMP CONTROL. 6. Touch START. <p>(See Page 28 for more detailed instructions.)</p> | <p>To set:</p> <ol style="list-style-type: none"> 1. Touch CLEAR. 2. Touch NEW RECIPE. 3. Touch RECIPE #. 4. Touch numbers for New Recipe #. 5. Program Recipe following suitable operating instructions. 6. Touch NEW RECIPE. <p>(See Page 31 for more detailed instructions.)</p> |
| <p>PROGRAMMED DEFROST BY TIME</p> | <p>PRESET RECIPE COOKING (Auto Recipe 300 & 3 Customer Programmable Recipes)</p> | <p>HOOD FAN CONTROL</p> |
| <p>To set:</p> <ol style="list-style-type: none"> 1. Touch CLEAR. 2. Touch PROGRAMMED DEFROST. 3. Touch numbers for desired defrost time. 4. Touch START. <p>(See Pages 23 thru 27 for more detailed instructions.)</p> | <p>To set:</p> <ol style="list-style-type: none"> 1. Touch CLEAR. 2. Touch Recipe#. 3. Touch numbers for correct Preset Recipe#. 4. Touch START. <p>(See Pages 29 thru 31 for more detailed instructions.)</p> | <p>To set:</p> <ol style="list-style-type: none"> 1. Touch FAN once for low speed and twice for high speed. 2. Touch FAN again for turning the fan off. <p>* If over-heating of the Oven occurs, the fan will run by itself until the temperature of the Oven drops to a safe level.</p> |

RECALL AND CHANGE OF SETTINGS

To Recall a Setting

To recall (check) a setting **before you start the oven**, follow the directions below.

- To check the setting for a given stage, touch MEMORY/RECALL one or more times until the correct stage light and indicator light turns on. The set TIME or TEMP CONTROL for that stage will show in the display window.
- To check the cooking power level, touch COOK CONTROL.

To recall (check) a setting **while the oven is operating**, follow the directions below.

- To check settings while the oven is operating, touch the desired pad to recall the setting for the operating stage.
- To recall a future stage, touch STOP, follow the directions above for recalling (checking) a setting before starting the oven, and then touch START to continue cooking.
- To recall TIME OF DAY while the oven is running, touch TIME OF DAY. It will show momentarily in the display window.
- To recall Recipe number (s) while the oven is running, touch RECIPE #, and it will show momentarily in the display window.

To Change a Setting

Recall the setting to be changed by following the directions above and make the change as follows:

- Touch STOP The oven will stop cooking.
- Touch TIME Then touch "0" until only one "0" shows in the display window. Set the cooking time.
- Touch TEMPERATURE CONTROL Set cooking temperature.
- Touch COOK CONTROL Set cooking power level. To reset to "HI", set "99", maximum power.

PAUSE BETWEEN STAGES

Some recipes require stirring, turning and adding or removing of foods between stages. To set the oven to stop between stages, touch PAUSE rather than MEMORY/RECALL when setting the oven. After the pause, to restart the oven, touch START.

REGULAR TIMER

Your oven also has a timer that can be used for noncooking functions. When used as a regular timer, the oven is not running. The timer is simply counting down in seconds. For detailed instructions on using this timer, see below.

To use the regular timer feature:

1. Touch CLEAR.
2. Touch TIME.
3. Touch correct numbers for the time.
4. Touch COOK CONTROL.
5. Touch "0" (power level 0).
6. Touch START. The time will begin counting down in the display window with no cooking or heating in the oven. A tone will sound when the time is over.

“HI-POWER” COOKING

1. Touch CLEAR, and a beep tone will be heard. The CLEAR erases all previous settings.
2. Touch TIME. The lights above TIME and below STAGE 1 will go on. (“0” will show in the display window.)
3. Touch the correct numbers on the control panel to set the cooking time. The time set will show in the display window at the top of the control panel. For example:
 - To set 30 seconds, you would touch “3” and then “0”.
 - To set 3 minutes, touch “3”, “0” and “0”.
 - To set 3½ minutes, touch “3”, “3” and “0”.

Remember, the timer is a digital clock that is divided into minutes and seconds. Therefore, ½ minute is equal to 30 seconds. Touch 30 and not 50 as with a calculator to indicate ½.

NOTE: It is not necessary to touch COOK CONTROL when cooking with the highest power (“HI”). However, if COOK CONTROL is touched, the light above COOK will go on and the word “HI” will show in the display window. This is to let you know that the oven will be operating on “HI” power unless a different power setting is chosen.

4. Touch START. The oven will begin cooking, and the display window will show the time counting down in seconds. A tone sounds for two seconds when the cooking time is completed. Then the oven shuts itself off.

NOTE: To stir food during cooking: open the oven door; stir or turn the food; close the oven door; and touch START. The oven will automatically continue to count down the amount of time left on the timer.

EXAMPLE: Fresh fish can be cooked quickly on “HI” (maximum power) for 6 minutes. To do this, follow these 4 simple steps:

1. Touch CLEAR.
2. Touch TIME.

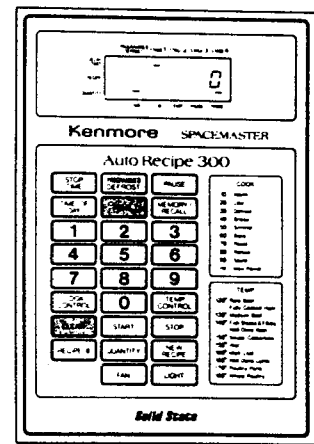

3. Set 6 minutes by touching “6”, “0” and “0”. “600” will show in the display window.

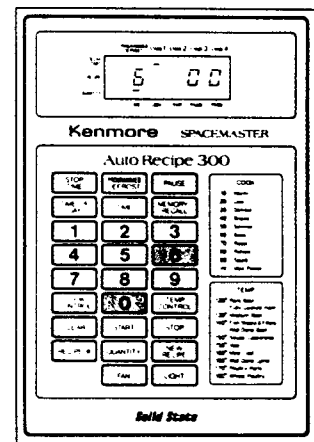

4. Touch START. The oven will begin to cook and the time will begin to count down in the display window. A tone will sound for 2 seconds when the 6 minutes are over and the oven will shut itself off.

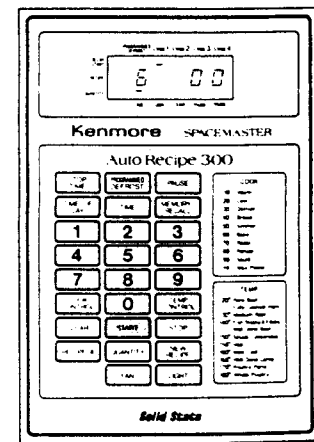

COOKING GUIDE FOR “MULTI-POWER” SETTINGS

The “Multi-Power” feature lets you cook at the best power level for the food being cooked. Cooking directions can be found in the cookbook.

| POWER LEVEL | POWER SETTINGS | EXAMPLES |
|-------------|----------------|---------------------------------------------------------------------------------------------------------------------------------------------------------------------------------------------------------------------------------------------------------------------------|
| 10 | WARM | <ul style="list-style-type: none"> • Softening cream cheese. • Keeping casseroles and main dishes warm. |
| 20 | LOW | <ul style="list-style-type: none"> • Softening chocolate. • Heating breads, rolls, pancakes, tacos, tortillas and French toast. • Clarifying butter. • Taking the chill out of fruit. • Heating small amounts of food. |
| 30 | DEFROST | <ul style="list-style-type: none"> • Thawing meat, poultry and seafood. • Completing the cooking cycle of casseroles, stews and some sauces. • Cooking small quantities of most food. |
| 40 | BRAISE | <ul style="list-style-type: none"> • Cooking less tender cuts of meat in liquid or slow cooking dishes. • Completing the cooking cycle of less tender roasts. |
| 50 | SIMMER | <ul style="list-style-type: none"> • Cooking stews and soups after bringing to a boil. • Cooking baked custards and pasta. |
| 60 | BAKE | <ul style="list-style-type: none"> • Cooking scrambled eggs. • Cooking cakes. |
| 70 | ROAST | <ul style="list-style-type: none"> • Cooking rump roast, ham, veal, and lamb. • Cooking cheese dishes. • Cooking eggs and milk. • Cooking quick breads and cereal products. |
| 80 | REHEAT | <ul style="list-style-type: none"> • Reheating precooked or prepared food quickly. • Heating sandwiches. |
| 90 | SAUTÉ | <ul style="list-style-type: none"> • Cooking onions, celery and green peppers quickly. • Reheating meat slices quickly. |
| 100 (HI) | MAX POWER | <ul style="list-style-type: none"> • Cooking tender cuts of meat. • Cooking poultry, fish, vegetables and most casseroles. • Preheating the browning dish. • Boiling water. • Thickening some sauces. |

As you get to know your microwave oven, you may find that a particular setting is too low or too high for the results you desire.

Multiple-power control gives you the means to obtain greater precision in setting power levels. For instance, if you want a power level between ROAST and REHEAT, you would set the time as usual: touch COOK CONTROL, and then touch “7” and “5”. The display window will show “75”, indicating that your oven is set to run at Power Level 75 — halfway between ROAST and REHEAT.

“MULTI-POWER” COOKING

Many foods need slower cooking (at less than full power) in order to give you the best results. In addition to “HI” there are ninety-nine multi-power settings. The cookbook tells you which power setting is recommended for the food being cooked.

To Cook with “Multi-Power”

1. Touch CLEAR.
2. Touch TIME. The lights above TIME and below STAGE 1 will go on. (“0” will show in the display window.)
3. Touch numbers for the desired cooking time. The time set will show in the display window.
4. Touch COOK CONTROL. The light above COOK will go on. Also, the word “HI” will show in the display window until a lower setting is entered. This is to tell you that the oven will be operating on “HI” power unless a different power setting is chosen.
5. Touch numbers for desired cooking power level. For example, if the recipe calls for cooking at the “20 (LOW)” setting, you would touch “2” and “0”. The display window will show “20”. This means that the oven is in a LOW setting, the oven is cooking at power level 20.
6. Touch START. The oven begins to cook and the display window will show the time counting down. A tone will sound for 2 seconds when the cooking time is over. Then the oven shuts itself off.

Example: To warm 6 doughnuts, you would cook at power level “80 (REHEAT)” for 1-1/2 minutes. To do this, follow these six steps:

1. Touch CLEAR.
2. Touch TIME.
3. Set 1-1/2 minutes by touching “1”, “3”, and then “0”. “130” will show in the display window.

4. Touch COOK CONTROL. The display window will show “HI”.

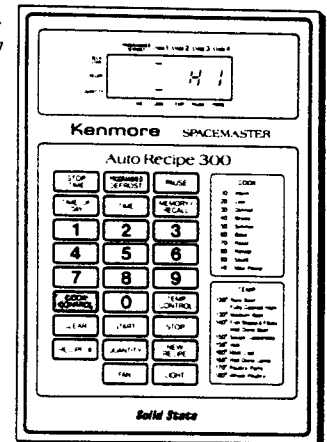

5. Choose the “80 (REHEAT)” setting by touching the numbers “8” and “0”. The display window will show “80”. This means the oven is cooking at power level 80.

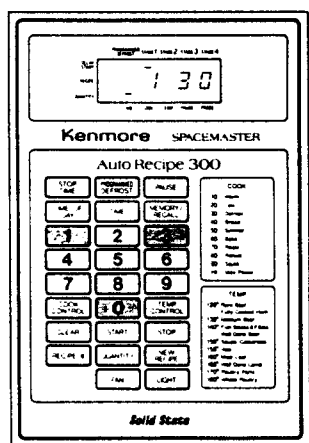
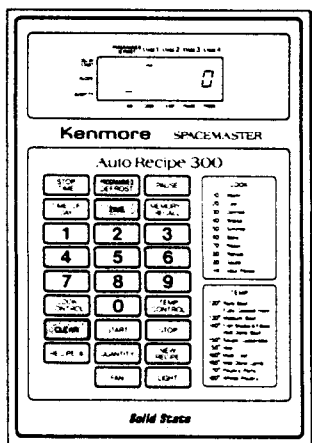
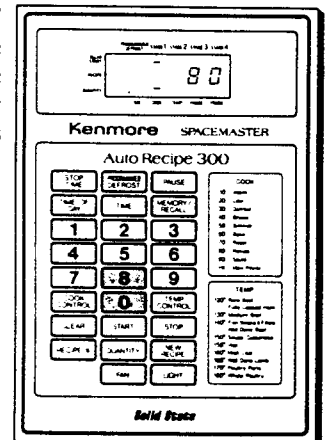

6. Touch START. The oven begins to cook and the time will begin to count down in the display window. A tone will sound for 2 seconds when the 1-1/2 minutes are over and the oven will shut itself off.

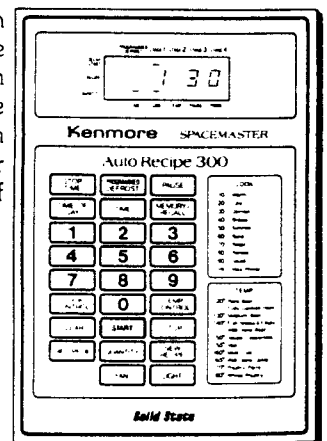

“TEMPERATURE CONTROLLED” COOKING

The temperature probe is used to judge doneness when cooking or reheating food. Set the desired food temperature with the TEMP CONTROL and the desired power level with the COOK CONTROL. When the food reaches the desired temperature, the oven will hold the food at the desired temperature up to one hour.

TEMPERATURE SETTING & DISPLAY TEMPERATURE

Temperatures from 90°F to 200°F can be chosen and set in the oven. The temperature should be set in one-degree increment.

The display window will show the rise in food temperature in one-degree increment.

The display window will not accurately show food temperature below 90°F.

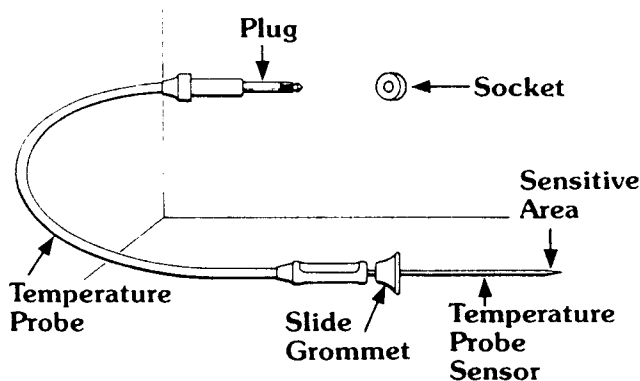

DEFINITIONS

TEMPERATURE PROBE SENSOR: The pointed metal portion of the probe which is placed into the food.

SENSITIVE AREA OF SENSOR: The first inch, or tip, of the temperature probe sensor.

PLUG: The end of the temperature probe that is plugged into the oven socket.

SOCKET: The outlet on the side of the oven wall.

CAUTION: Do not plug the pointed end of the temperature probe into the socket.

SLIDE GROMMET: Adjust the length of the temperature probe by sliding the grommet before inserting it into food so that the sensitive area of the probe can always be placed in the center of the food.

DISPLAY WINDOW: Shows the cooking temperature rising as the food is cooking. Chosen temperature may be seen during cooking by touching TEMP CONTROL. When chosen temperature is reached the display will show “Hold” for 60 minutes or until the door is opened or STOP is touched.

MEATS

- Choose only fresh, completely thawed meat.
- Place meat fat side down on the microwave roasting rack in a glass baking dish.
- Microwave cook on the first “multi-power” setting for half of the total cooking time. (See “Temperature Control” Meat Cooking Guide on Page 15.)
- Turn meat to fat side up and:

1. Place the temperature probe sensor into the meat with the first inch of the sensor in the center of the meat. The sensor should not touch the bone or fat pocket. The sensor should be put in from the side or from the front—it should not be put in from the top of the meat.
2. Plug the temperature probe into the socket on the side of the oven wall.
3. Choose the doneness temperature from the chart on Page 16. Set the temperature with the TEMP CONTROL.
4. Microwave cook the meat on the second “multi-power” setting. The microwave oven will turn itself off when the preset temperature is reached. Take the food out of the oven as soon as the display window shows “Hold”.
5. Remove the temperature sensor. Let the meat stand, covered with foil for about 10 minutes before serving. The temperature will rise about 15°F during standing time.

Note: It is normal for meats to become slightly overcooked in a small circular area in the immediate vicinity of the hole made by the meat probe.

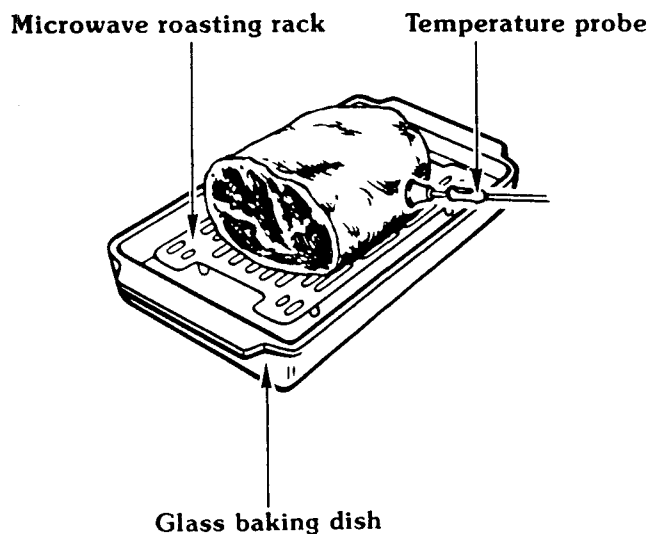

“TEMPERATURE CONTROL” POINTS TO REMEMBER

DO

- Place the temperature probe sensor into the thickest part of the meat or in the center of the food to be reheated. Avoid touching bone or fat.
- Check that the first inch of the sensor is in the densest part of the food to be cooked.
- Remove the temperature probe from the oven after use.
- Refer to cookbook for other information.

DO NOT

- Do not operate the oven while empty with the temperature probe plugged in.
- Do not let the temperature probe sensor touch the sides, bottom or door of the oven while in use.
- Do not use the temperature probe in a regular oven.
- Do not forget to turn meat between first and second settings.

“TEMPERATURE CONTROL” MEAT COOKING GUIDE

Refer to “Meats” section on Page 14.

| MEAT | FIRST SETTING AND TIME | SECOND SETTING AND TIME | TEMPERATURE PROBE AND COOK CONTROL SETTING | STANDING TIME |
|-----------------------------------------------------------|---------------------------------------------------------------------------------------------------------|----------------------------------------------------------------------------------------------------|--------------------------------------------|-------------------------------|
| BEEF Meat Loaf 2 lbs. | HI (Max. Power) 12 – 14 min. | | HI (Max. Power) 160°F | 5 – 10 min. |
| Rib Roast, boneless | HI (Max. Power) Rare 4 – 5 min. per lb. Medium 5 – 6 min. per lb. Well done 6 – 7 min. per lb. | 70 (Roast) Rare 3 – 4 min. per lb. Medium 5 – 6 min. per lb. Well done 6 – 7 min. per lb. | 70 (Roast) 120°F 130°F 140°F | 10 min. 10 min. 10 min. |
| Rib Roast, with bone | HI (Max. Power) Rare 3 – 4 min. per lb. Medium 4 – 5 min. per lb. Well done 5 – 6 min. per lb. | 70 (Roast) Rare 3 – 4 min. per lb. Medium 3 – 5 min. per lb. Well done 5 – 6 min. per lb. | 70 (Roast) 120°F 130°F 140°F | 10 min. 10 min. 10 min. |
| LAMB Lamb Leg or Shoulder Roast, with bone | 70 (Roast) Medium 4 – 5 min. per lb. Well done 5 – 6 min. per lb. | 70 (Roast) Medium 4 – 5 min. per lb. Well done 5 – 6 min. per lb. | 70 (Roast) 145°F 165°F | 5 min. 10 min. |
| Lamb Roast, Boneless | 70 (Roast) 5 – 6 min. per lb. | 70 (Roast) 5 – 6 min. per lb. | 70 (Roast) 150°F | 10 min. |
| VEAL Shoulder or Rump Roast, boneless 2 – 5 lbs. | 70 (Roast) 9 min. per lb. | 70 (Roast) 9 – 10 min. per lb. | 70 (Roast) 155°F | 10 min. |
| PORK Pork Loin Roast, boneless 3 – 5 lbs. | HI (Max. Power) 6 min. per lb. | 70 (Roast) 5 – 6 min. per lb. | 70 (Roast) 160°F | 10 min. |
| Pork Loin, center cut 4 – 5 lbs. | HI (Max. Power) 5 – 6 min. per lb. | 70 (Roast) 4 – 5 min. per lb. | 70 (Roast) 160°F | 10 min. |
| Ham, boneless, precooked | 70 (Roast) 5 – 7 min. per lb. | 70 (Roast) 5 – 7 min. per lb. | 70 (Roast) 120°F | 10 min. |
| Center Cut Ham Slice 1 – 1½ lbs. | 70 (Roast) 5 min. per lb. | 70 (Roast) 5 – 6 min. per lb. | 70 (Roast) 120°F | 10 min. |
| Smoked Ham Shank | 70 (Roast) 4 – 5 min. per lb. | 70 (Roast) 4 – 5 min. per lb. | 70 (Roast) 120°F | 10 min. |
| Canned Ham 3 lbs. | 70 (Roast) 5 – 6 min. per lb. | 70 (Roast) 5 – 6 min. per lb. | 70 (Roast) 120°F | 10 min. |
| 5 lbs. | 70 (Roast) 4 – 5 min. per lb. | 70 (Roast) 4 – 5 min. per lb. | 70 (Roast) 120°F | 10 min. |

REHEATING FOODS

- Place the temperature probe sensor into the food to be reheated with the first inch of the sensor in the center of the food.
- Plug the temperature probe into the socket on the side of the oven wall.
- Cover the food if desired.
- Set the temperature of the desired doneness. (See chart below.)
- Select “multi-power” setting as shown below.
- The microwave oven will stop cooking when the set temperature is reached and then it will “Hold Warm”.
- Remove the temperature probe from the oven after use.

“TEMPERATURE CONTROL” REHEATING GUIDE

| FOOD | SETTING | DONENESS | INSTRUCTIONS |
|-------------------------|----------------|----------|---------------------------------------------------------------------------------------------------------------------------------------------------------------------|
| Beverages | HI (MAX POWER) | 150°F | Place the temperature probe sensor in the center of the beverage glass. |
| Soups | 80 (REHEAT) | 150°F | Place the temperature probe sensor into the center of the soup. Cover with casserole lid, waxed paper, or plastic wrap. |
| Precooked Casseroles | 80 (REHEAT) | 150°F | Place temperature probe sensor into the center of the food. Cover with a casserole lid, waxed paper, or plastic wrap. |
| Canned Vegetables | 80 (REHEAT) | 150°F | Place the temperature probe sensor into the center of the food to be reheated. The sensitive area of the sensor should rest in the middle of the food. |
| Leftovers | 80 (REHEAT) | 150°F | Place the temperature probe sensor in the densest or largest amount of food. |
| Meat Sandwiches (Thick) | 80 (REHEAT) | 120°F | Place the temperature probe sensor into the thickest part of the sandwich to be warmed. The sensitive area of the sensor should be located in the sandwich filling. |
| Baked Foods | 80 (REHEAT) | 120°F | Place the temperature probe sensor into the center of the food to be reheated. The sensitive area of the sensor should rest in the middle of the food. |
| Syrup | 70 (ROAST) | 150°F | Place the temperature probe sensor into the center of the container. |

Caution: From time to time, the same kind of foods may vary in shape, form and density, and, therefore will not produce the same results each time. For this reason, we do not recommend using the temperature control settings for thin food items or for foods that require tenderiz-

ing by simmering. Also, in some cases the microwave oven may shut off prematurely. This means that either the temperature probe is not placed properly or that it should not be used with this type of food.

TEMPERATURE CONTROLLED "HI-POWER" COOKING AND AUTOMATIC "HOLD WARM"

The "Temperature Control Meat Cooking Guide" and "Reheating Guide" on Pages 15 and 16 will show you which multi-power setting and doneness temperature are recommended for the food you are cooking. When cooking with the temperature control settings, the timer is not used.

- Place the temperature probe into the food with the first inch of the sensor in the center of the food. Adjust the length of the temperature probe by sliding the grommet before inserting it into food so that the sensitive area of the probe can always be placed in the center of the meat. The probe should be in a level direction or on an angle as shown. *It should not be put in from the top.*

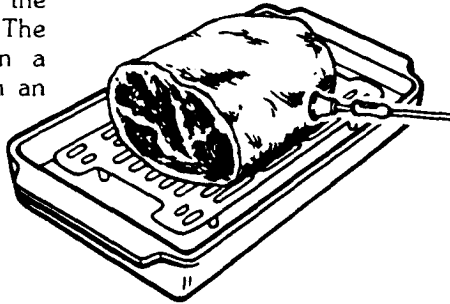

- Plug the temperature probe into the socket on the side of the oven.

Caution: Do not plug the pointed end of the temperature probe into the socket.

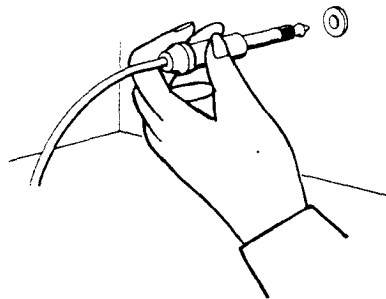

- Touch CLEAR.

- Touch TEMP CONTROL. The lights above TEMP and below STAGE 1 will go on, and "F" will show in the display window.

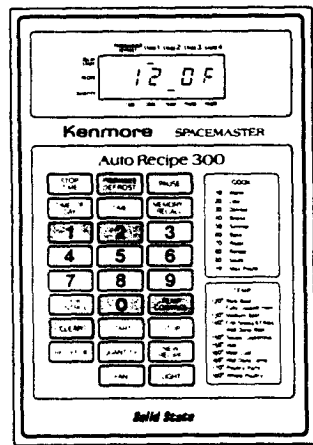

- Choose the food temperature and touch the corresponding numbers. For example, if the recipe calls for doneness at 120°F, you would touch the numbers "1", "2" and "0". When you touch "120" the display window will show "120F". If the temperature probe is not plugged into the socket, the probe light will flash and the oven will not work.

NOTE: It is not necessary to touch COOK CONTROL when you are cooking with "HI (MAX POWER)". However, if you touch COOK CONTROL the light above COOK will go on and the word "HI" will show in the display window. This is to remind you that the oven will work at "HI (MAX POWER)" unless a different power setting is chosen.

- Touch START. The oven will begin to cook and you will be able to see the temperature of the food rising in the display window. A tone will sound for one second when the desired temperature is reached.

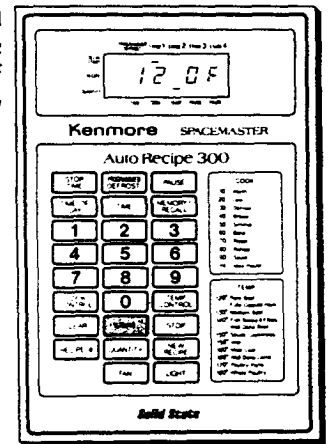

- The oven will switch into "Hold Warm" to keep the food warm. "Hold" will show in the display window. The cook control setting changes to "10 (WARM)". To check the temperature being held, touch TEMP CONTROL. The "holding" temperature will show in the display window. The "Hold Warm" will continue for 60 minutes after the food reaches the chosen temperature or until the door has been opened or until STOP has been touched. If the door is opened, the "Hold Warm" will stop. To reset, simply touch TEMP CONTROL, the corresponding numbers and START.

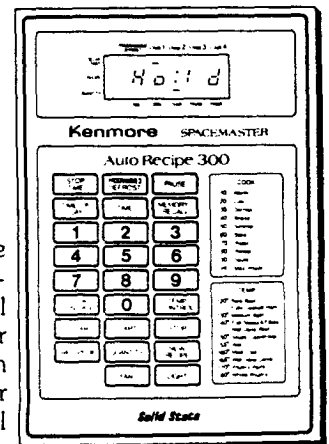

NOTE: The highest temperature to which the food may be set is 200°F. The temperature is displayed in 1°F increment.

TEMPERATURE CONTROLLED "MULTI-POWER" COOKING AND AUTOMATIC "HOLD WARM"

The "Temperature Control Meat Cooking Guide" and "Reheating Guide" on Pages 15 and 16 will show you which multi-power setting and temperature setting are recommended for the food you are cooking.

1. Place the temperature probe into the food with the first inch of the sensor in the center of the food. See step 1 on page 17.
2. Plug the temperature probe into the socket on the side of the oven. See step 2 on page 17.

CAUTION: Do not plug the pointed end of the temperature probe into the socket.

3. Touch CLEAR.
4. Touch TEMP CONTROL. The lights above TEMP and below STAGE 1 will go on, and "F" will show in the display window.

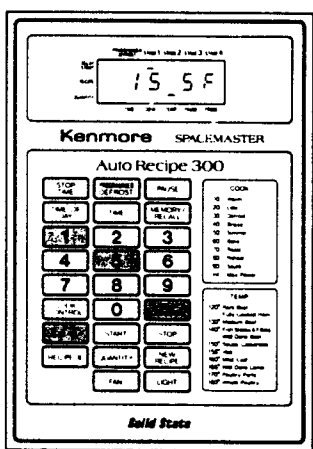

5. Choose the food temperature and touch the corresponding numbers. For example, if the recipe calls for doneness at 155°F, you would touch numbers "1" "5" and "5". When you touch "155", the display window will show "155F". If the temperature probe is not plugged into the socket, the probe light will flash and the oven will not work.

6. Touch COOK CONTROL. The light above COOK will go on. Also, the word "HI" will show in the display window until you enter a lower power setting. This is to remind you that the oven will always operate at full power unless you set a lower power.

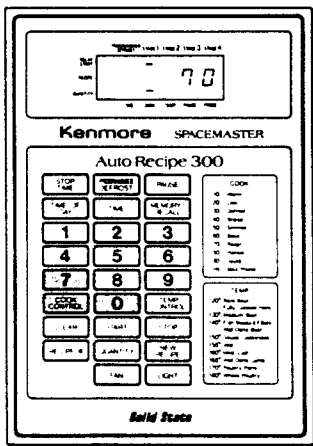

7. Choose the cook control setting you desire and touch the corresponding numbers. For example, if the recipe should call for cooking at the "70 (ROAST)" setting, you would touch numbers "7" and "0". When you touch "7" and "0", the display window will show "70". This means that in the "70 (ROAST)" setting, the oven is at power level 70.

8. Touch START. The oven will begin to cook and you will be able to see the temperature of the food rising in the display window.

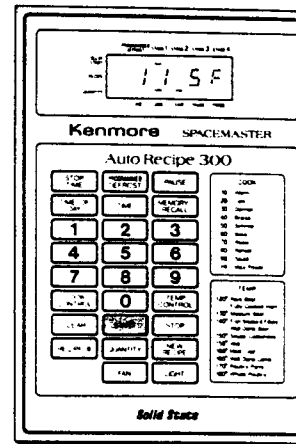

9. A tone will sound for one second when the temperature is reached. The oven will switch into "Hold Warm" to keep the food warm. The cook control setting automatically changes to "10 (WARM)". The display window will show "Hold".

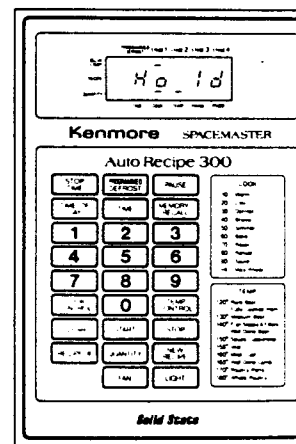

10. To be sure the correct temperature is being held, you may touch TEMP CONTROL. The "holding" temperature will show in the display window. The "Hold Warm" will continue for 60 minutes after the food reaches the chosen temperature or until the door has been opened or until STOP has been touched. If the door has been opened, the "Hold Warm" will stop. To reset, simply touch TEMP CONTROL, the corresponding numbers and START.

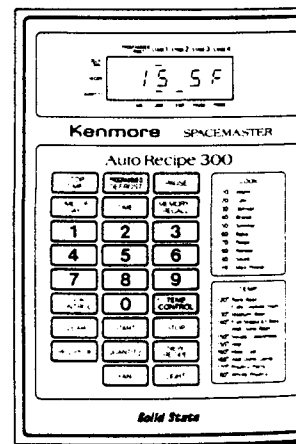

NOTE: The highest temperature that can be set is 200°F. The temperature is displayed in 1°F increment.

TWO, THREE OR FOUR-STAGE COOKING

Four-stage cooking lets you cook in four cooking stages each at a different power setting for a chosen time or temperature. Set all stages before cooking and start the oven. Simply follow these steps:

1. Touch CLEAR.
2. Touch TIME or TEMP CONTROL. The lights above TIME or TEMP and below STAGE 1 will go on. The display window will show "0" or "F".
3. Touch the correct numbers for the time or temperature of the first cooking stage.
4. Touch COOK CONTROL. The light above COOK will go on. The display window will show "HI".
5. Touch the correct numbers for the cooking power level of the first cooking stage (if other than "HI").
6. Touch MEMORY/RECALL or PAUSE. The light below STAGE 2 will go on. The display window will show "0".
7. Touch TIME or TEMP CONTROL.
8. Touch the correct numbers for the time or temperature of the second cooking stage.
9. Touch COOK CONTROL. The display window will show "HI".
10. Touch the correct numbers for the cooking power level in the second cooking stage (if other than "HI").
- 11A. Touch START for two-stage cooking.
- 11B. If three-stage or four-stage cooking is desired, touch MEMORY/RECALL or PAUSE. The light below STAGE 3 will go on. The display window will show "0".
Repeat steps 7-10 above to set the third cooking stage at the same or a different power level for a chosen time or temperature.
- 12A. Touch START for three-stage cooking.
- 12B. If four-stage cooking is desired, touch MEMORY/RECALL or PAUSE. The light below STAGE 4 will go on. The display window will show "0".
Repeat steps 7-10 above to set the fourth cooking stage at the same or a different power level for a chosen time or temperature.
13. Touch START.

EXAMPLE: (Four-stage cooking)
All-American Meat Balls
(10 minutes, power level 70) (PAUSE)
(3 minutes, power level 70) (PAUSE)
(2 minutes, power level 70)
(MEMORY/RECALL)
(5 minutes, power level 0)

The following steps explain how to set the oven.

First Stage (10 minutes; power level 70)

1. Touch CLEAR.
2. Touch TIME.
3. Set 10 minutes by touching "1", "0", "0" and "0". "1000" will show in the display window.

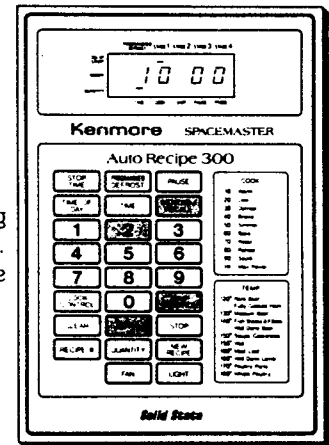

4. Touch COOK CONTROL. "HI" will show in the display window to remind you that the oven will operate at highest power unless you enter a lower power setting.
5. Touch numbers "7" and "0". "70" will show in the display window (indicating that you have set the oven to operate at power level 70). The first stage has been set.

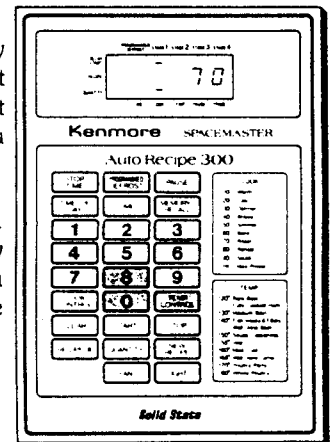

TWO, THREE OR FOUR-STAGE COOKING (Cont'd)

Second Stage (3 minutes; power level 70)

6. Touch PAUSE. The light below STAGE 2 will go on. The display window will show "0".
7. Touch TIME.
8. Set 3 minutes by touching "3", "0" and "0". "300" will show in the display window.
9. Touch COOK CONTROL and numbers "7" and "0". "70" will show in the display window. The second stage has been set.

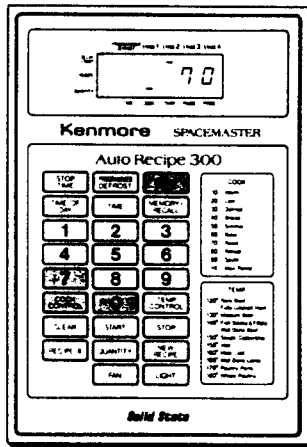

17. Touch COOK CONTROL and number "0". "0" will show in the display window. The fourth stage has been set.

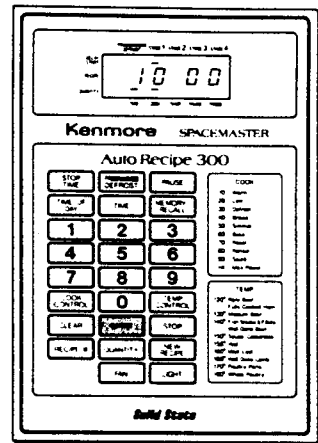

18. Touch START. The first stage will begin cooking. "1000" will show in the display window. The oven will begin to cook at a power level 70 and the time will begin to count down in the display window. When the 10 minutes are over, a tone will sound and the oven will stop. "PAUSE" will show in the display window.

Third Stage (2 minutes; power level 70)

10. Touch PAUSE. The light below STAGE 3 will go on. The display window will show "0".
11. Touch TIME.
12. Set 2 minutes by touching "2", "0" and "0". "200" will show in the display window.
13. Touch COOK CONTROL and numbers "7" and "0". "70" will show in the display window. The third stage has been set.

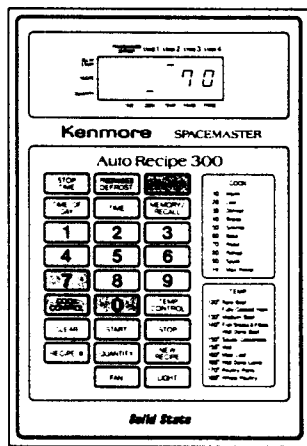

After the pause, to restart the oven, touch START for second cooking stage. "300" will show in the display window. The oven will begin to cook at "70" power level. When the 3 minutes are over, a tone will sound and the oven will stop. "PAUSE" will show in the display window.

After the pause, to restart the oven, touch START for third cooking stage. "200" will show in the display window. The oven will begin to cook at "70" power level. When 2 minutes are over, a tone will sound and the oven will change itself into the fourth stage. "500" will show the display window. When 5 minutes as "Standing time" are over, a tone will sound. The oven would have finished four stages.

Fourth Stage (5 minutes; power level 0)

14. Touch MEMORY/RECALL. The light below STAGE 4 will go on. The display window will show "0".
15. Touch TIME.
16. Set 5 minutes by touching "5", "0" and "0". "500" will show in the display window. The fourth stage has been set.

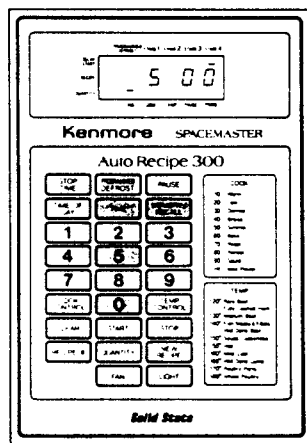

NOTES: When temperature control cooking is set in the fourth stage, the oven will switch into "Hold Warm" after cooking. The "Hold Warm" will continue for 60 minutes after the food reaches the chosen temperature or until the door has been opened or until STOP has been touched.

*"Standing time" allows the food to finish cooking and the heat to be uniform throughout. See the cookbook for detailed explanation.

If you touch MEMORY/RECALL instead of PAUSE, the oven will not stop but will remember the next stage and continue working.

DELAY START COOKING

Delay Start cooking can be done by starting the cooking automatically and finishing at a presetting delay time for the chosen cooking time.

1. Touch CLEAR.

2. Touch STOP TIME.

The light at right of DELAY START goes on. A display window will read "0:00".

3. Touch numbers for the time of day to finish cooking. For example, touch numbers "7", "3" then "0" for the cooking to be finished at "7:30", and "7:30" will show in the display window.

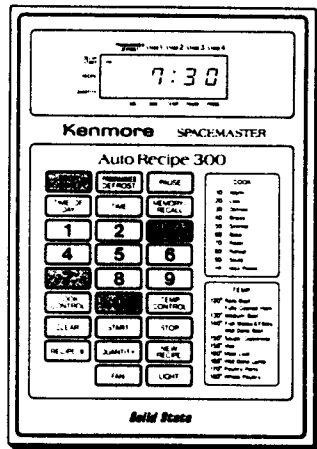

6. Touch COOK CONTROL.

7. Touch numbers for cooking power level.

For example, touch numbers "5" then "0", "50" will show in the display window.

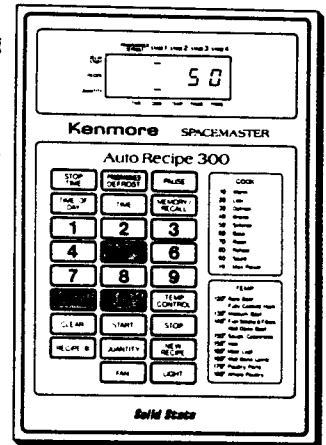

4. Touch TIME.

5. Touch numbers for cooking time.

For example, set 12 minutes by touching "1" then "2" then "0" twice. "1200" will show in the display window.

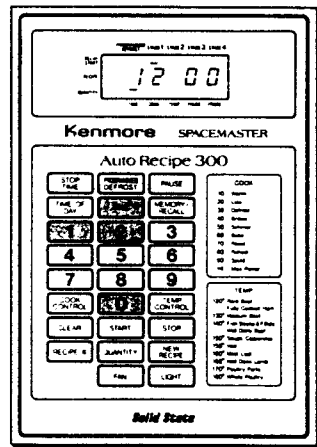

8. Touch START.

The time of day will show in the display window and the light at right of DELAY START goes on. As soon as the clock shows the Cook-Start Time which has been subtracted from the Cook-Finish Time, the oven will start cooking and the cooking time counts down in the display window. When the Cook-Finish Time (or "7:30") comes, the oven will shut itself off.

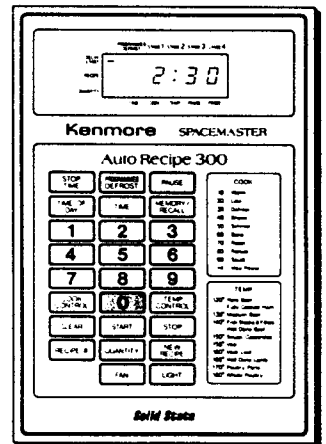

The display shows the time of day. For example: a half past two.

Note: A preset delay time must be less than 12 hours.

* Four-Stage cooking can be used with Delay Start. After step 3 above, follow instructions for Four-Stage cooking beginning with step 2.

* The Delay Start cooking is controlled by time. When "Temperature Control" cooking is set in a stage, cooking may be finished at the setting time with a slight time difference.

* Fresh food should not stand at room temperature over four hours prior to cooking.

WHOLE MEAL COOKING

(See Cookbook for detailed explanation)

Whole Metal cooking lets you cook two or more different foods at the same time. Foods need not be placed in the oven at the same time, nor be removed at the same time, unless needed. By using PAUSE rather than MEMORY/RECALL, the oven will stop between stages for time to add or remove food.

1. Place the Metal Rack in guides on the side wall of oven cavity as shown.
2. Place food into the oven.
3. Set the oven following the instructions given in the cook book.

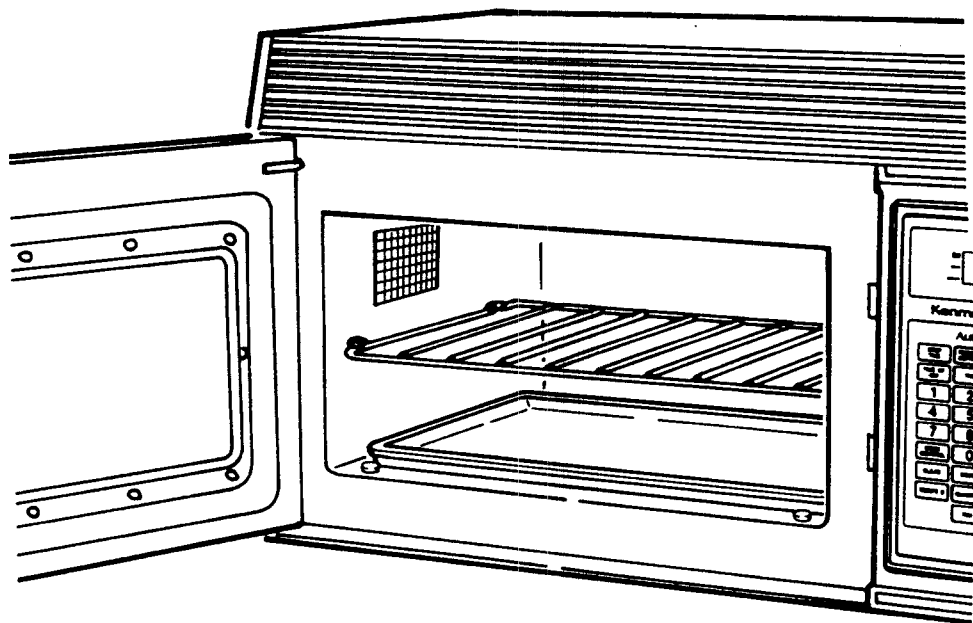

METAL RACK

- Remove Metal Rack from oven when not being used for cooking.
- Do not run the oven empty with the Metal Rack in it.
- The Metal Rack may get hot during cooking. Pot holders may be needed to remove Rack after cooking.
- Do not use browning dishes on Metal Rack.
- Do not use foil or metal containers on the Metal Rack.

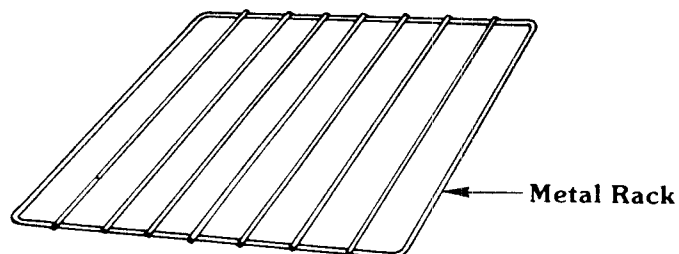

PROGRAMMED DEFROST BY TIME

The power levels for defrosting are predetermined and programmed into this oven. The oven will defrost at "HI" power for the beginning of the chosen time and at power level 30 for the remaining period of time.

1. Touch CLEAR.
2. Touch PROGRAMMED DEFROST. The light below PROGRAMMED DEFROST will go on and "0" will show in the display window.
3. Set the defrosting time by following the "Programmed Defrosting Chart" on Pages 24 through 27.
4. Touch START. The oven will begin and the time will begin counting down in the display window. A tone will sound when the time is over and the oven will shut itself off.

NOTE: If you want to cook after using the PROGRAMMED DEFROST CYCLE, touch MEMORY/RECALL, then set the standing time from chart pp. 24—27 at 0 power level; touch MEMORY/RECALL and set the time and power level for cooking the thawed food. Up to five stages can be set when PROGRAMMED DEFROST is one of the stages.

3. Set 9 minutes by touching "9", "0" and "0". "900" will show in the display window.

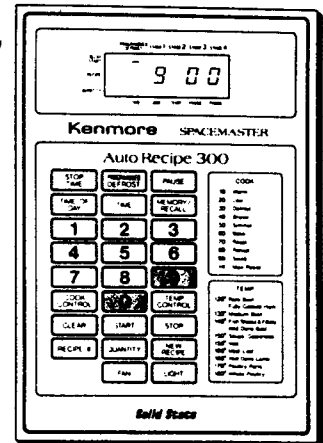

EXAMPLE: To defrost two pounds of ground beef, use the PROGRAMMED DEFROST cycle for 9 minutes.

1. Touch CLEAR.
2. Touch PROGRAMMED DEFROST. The light below PROGRAMMED DEFROST will go on. The display window will show "0".

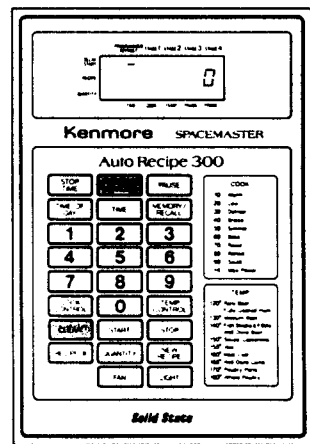

4. Touch START. The oven will begin to operate and time will begin to count down in the display window. A tone will sound when time is over and the oven will shut itself off.

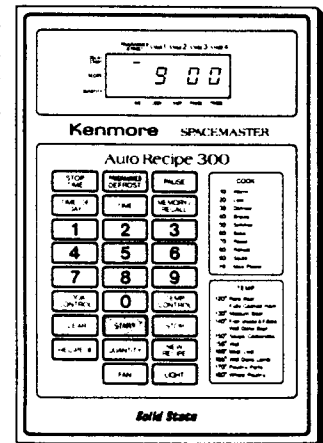

PROGRAMMED DEFROSTING CHART

The defrosting times in this chart have been made available specifically for use with the "Programmed Defrost by Time" feature.

PROGRAMMED DEFROSTING INSTRUCTIONS:

- Fish, seafood, meat or poultry can be thawed in their original closed package.
- Metal clip and pop-up timers may be left in poultry. Metal twistars must be removed from bags. They may be replaced with rubber bands.
- Place food in a flat glass baking dish to catch drippings.
- Use the "Programmed Defrost" setting to thaw fish, seafood, meat and poultry, according to the times in the chart below. Thaw completely before cooking.
- Food should still be somewhat icy in the center when removed from the oven.
- The chart gives you standing times and standing techniques needed to complete the thawing process.

IMPORTANT NOTE: The defrosting power setting (power level 30) should not be confused with this "Programmed Defrost." The defrost cooking level is a low-energy setting used to cook foods that need slow, gentle cooking. Use the defrost cooking level to reheat many frozen convenience foods and also to defrost small bread items.

| CUT AND WEIGHT | PROGRAMMED DEFROSTING TIME | STANDING TIME | DIRECTIONS |
|-----------------------------------------------|----------------------------|------------------|---------------------------------------------------------------------------------------------------------------------------------------------------------------------------------------------|
| FISH AND SEAFOOD | | | |
| FISH Fish fillets 1 lb. 2 lbs. | 4 to 5 min. 5 to 6 min. | 5 min. 5 min. | Defrost in package on dish. Carefully separate fillets under cold water. Turn over once.* |
| Fish steaks 1 lb. | 4 to 5 min. | 5 min. | Defrost in package on dish. Carefully separate steaks under cold, running water. |
| Whole Fish 8 to 10 oz. 1½ lb. to 2 lbs. | 3 to 5 min. 4 to 6 min. | 5 min. 5 min. | Use a shallow dish; the shape of the fish determines size. The fish should be icy when removed. Finish at room temperature. Cover the head with aluminum foil. Turn over once.* |
| Lobster tails 8 oz. pkg. | 4 to 6 min. | 5 min. | Remove from package to baking dish. |
| Crab legs 8 to 10 oz. | 4 to 6 min. | 5 min. | Use a glass baking dish. Break the legs apart. Turn over once.* |
| Crabmeat 6 oz. | 3 to 4 min. | 5 min. | Defrost in package on dish. Break apart. Turn over once.* |

* Turning or stirring should be done in the middle of the defrosting cycle.

PROGRAMMED DEFROSTING CHART (Cont'd)

| CUT AND WEIGHT | PROGRAMMED DEFROSTING TIME | STANDING TIME | DIRECTIONS |
|-----------------------------------------------|-----------------------------|------------------|---------------------------------------------------------------------------------------------------------------------------------------------------------|
| Shrimp 1 lb. | 2 to 3 min. | 5 min. | Remove from package to dish. Spread loosely in baking dish and rearrange during thawing as necessary. |
| Scallops 1 lb. | 7 to 9 min. | 5 min. | Defrost in package, if in block; spread out on baking dish if in pieces. Turn over and rearrange during thawing as necessary. |
| Oysters 12 oz. | 2 to 3 min. | 5 min. | Remove from package to dish. Turn over and rearrange during thawing as necessary. |
| MEAT | | | |
| BEEF Ground beef 1 lb. 2 lbs. | 4 to 4½ min. 8 to 9 min. | 5 min. 5 min. | Turn over once.* Remove thawed portions with fork. Return remainder into oven to defrost. The best way to freeze ground beef is in a doughnut shape. |
| Pot roast, chuck Under 4 lbs. | 3 to 4 min. per lb. | 10 min. | Turn over once.* |
| Rib roast, rolled 3 to 4 lbs. | 5 to 7 min. per lb. | 30-45 min. | Turn over once.* |
| Rump roast 3 to 4 lbs. | 3 to 4 min. per lb. | 30 min. | Turn over once.* |
| Round steak | 3 to 4 min. per lb. | 5-10 min. | Turn over once.* |
| Flank steak | 3 to 4 min. per lb. | 5-10 min. | Turn over once.* |
| Sirloin steak ½ inch thick | 3 to 4 min. per lb. | 5-10 min. | Turn over once.* |
| Tenderloin steak | 4 to 5 min. per lb. | 10 min. | Turn over once.* |
| Stew beef 2 lbs. | 3 to 4 min. per lb. | 8-10 min. | Turn over once.* Separate. |
| LAMB Cubed for stew | 6 to 7 min. per lb. | 5 min. | Turn over once.* Separate. |
| Ground lamb Under 4 lbs. | 3 to 4 min. per lb. | 30-45 min. | Turn over once.* |
| Chops 1 inch thick | 4 to 6 min. per lb. | 15 min. | Turn over twice.* |
| Leg 5 to 8 lbs. | 3 to 4 min. per lb. | 15-20 min. | Turn over twice.* |

* Turning or stirring should be done in the middle of the defrosting cycle.

PROGRAMMED DEFROSTING CHART (Cont'd)

| CUT AND WEIGHT | PROGRAMMED DEFROSTING TIME | STANDING TIME | DIRECTIONS |
|-------------------------------------------------|--------------------------------------------|----------------------|-------------------------------------------------------------------------------------------------|
| MEAT | | | |
| PORK Chops ½ inch thick 1 inch thick | 4 to 5 min. per lb. 5 to 6 min. per lb. | 5-10 min. 10 min. | Separate chops halfway through defrosting time. |
| Spareribs, Country-style ribs 2 to 3 lbs. | 4 to 6 min. per lb. | 10 min. | Turn over once.* |
| Roast Under 4 lbs. | 3 to 4 min. per lb. | 30-45 min. | Turn over once.* |
| Bacon 1 lb. | 1½ to 2½ min. | 3-5 min. | Defrost until strips separate. |
| Sausage, bulk 1 lb. | 1½ to 2½ min. | 3-5 min. | Turn over once.* Remove thawed portions with fork. Return remainder into oven to defrost. |
| Sausage, links 1 lb. | 2 to 4 min. | 4-6 min. | Turn over once.* Defrost until pieces can be separated. |
| Hot dogs 1 lb. | 4 to 5 min. | 5 min. | |
| VEAL Roast 3 to 4 lbs. | 4 to 6 min. per lb. | 30 min. | Turn over once.* |
| Chops ½ inch thick | 3 to 5 min. per lb. | 20 min. | Turn over once.* Separate chops and continue defrosting. |
| VARIETY MEAT Liver 1 lb. | 4 to 5 min. | 10 min. | Turn over once.* |
| Tongue 1 lb. | 6 to 7 min. | 10 min. | Turn over once.* |

* Turning or stirring should be done in the middle of the defrosting cycle.

PROGRAMMED DEFROSTING CHART (Cont'd)

| CUT AND WEIGHT | PROGRAMMED DEFROSTING TIME | STANDING TIME | DIRECTIONS |
|------------------------------------------------------------------------|-----------------------------------------------|--------------------|--------------------------------------------------------------|
| POULTRY | | | |
| Chicken Whole 2 to 3 lbs. | 5 to 7 min. per lb. | 25-30 min. | Turn over once.* Immerse in cold water for standing time. |
| Cut up 2 to 3 lbs. | 4 to 5 min. per lb. | 10-15 min. | Turn over once.* Separate pieces when partially thawed. |
| TURKEY Whole Under 8 lbs. | 3 to 4 min. per lb. | 60 min. | Turn over once.* Immerse in cold water for standing time. |
| Breast Under 4 lbs. | 3 to 4 min. per lb. | 20 min. | Turn over once.* |
| Drumsticks 1 to 1½ lbs. | 4 to 5 min. per lb. | 15-20 min. | Turn over once.* Separate pieces when partially thawed. |
| Roast, boneless 2 to 4 lbs. | 2½ to 3 min. per lb. | 10 min. | Remove from foil pan. Cover with waxed paper. |
| CORNISH HENS Whole 1. 1 to 1½ lbs. 2. 1 to 1½ lbs. ea. | 10 to 11 min. per lb. 9 to 10 min. per lb. | 20 min. 20 min. | Turn over once.* Turn over once.* |

* Turning or stirring should be done in the middle of the defrosting cycle.

PROGRAMMED DEFROST BY TEMPERATURE

Power levels for defrosting are predetermined in this oven. Thus, the temperature probe can assist in proper defrosting of large dense items, such as casseroles, poultry and roasts.

1. Cover the corners of food with small pieces of aluminum foil.

Place the food to be defrosted on a rack in a baking dish. The baking dish will collect drippings from the food while the rack will prevent the food from soaking in the drippings and will help it defrost evenly.

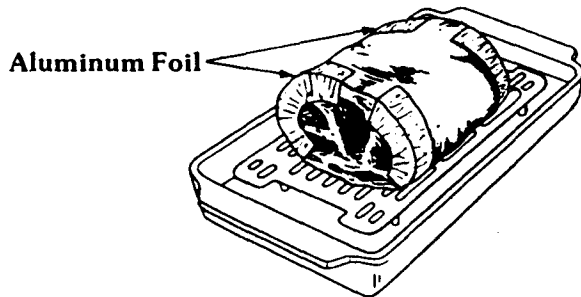

2. Adjust the slide grommet on the probe, so that the temperature probe can be placed into the food about 2-1/4" to 2-1/2" deep.

The probe should be placed horizontally about mid-height of the food and from the right-hand side. If the food is still hard and the temperature probe cannot be placed, use the probe spacer to make a 2-1/4" deep hole for the temperature probe. To avoid error, be sure the temperature probe is pushed to the bottom of the hole and do not place the temperature probe into fat, air pockets or areas near bones.

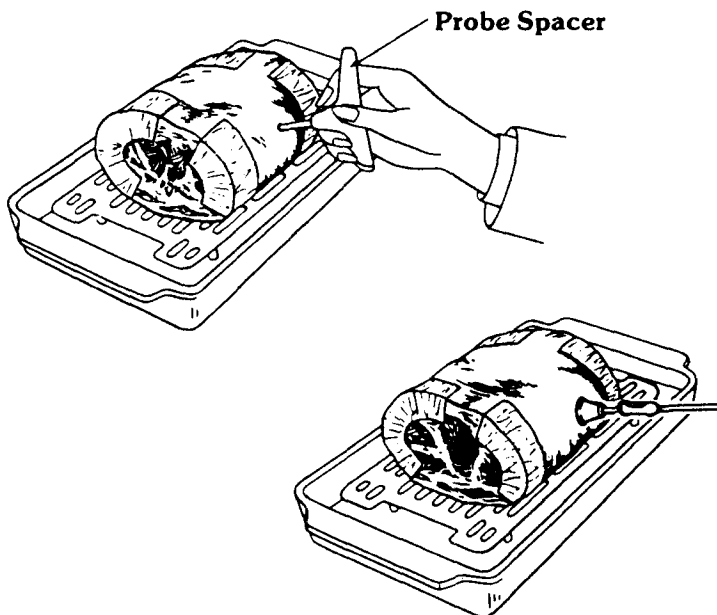

3. Plug temperature probe into socket on the side of the oven.

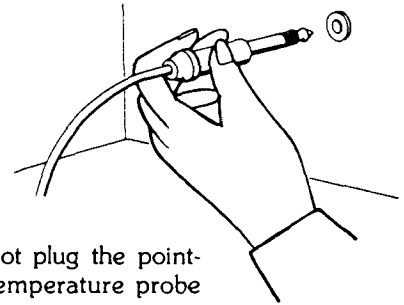

Caution: Do not plug the pointed end of the temperature probe into the socket.

4. Touch CLEAR.

5. Touch PROGRAMMED DEFROST. The light below PROGRAMMED DEFROST will go on and the display window will show "0".

6. Touch TEMP CONTROL.

The display window will show "dEF".

7. Touch START. The oven will start and the display window will show "dEF". A tone will sound for two seconds and the oven shuts itself off.

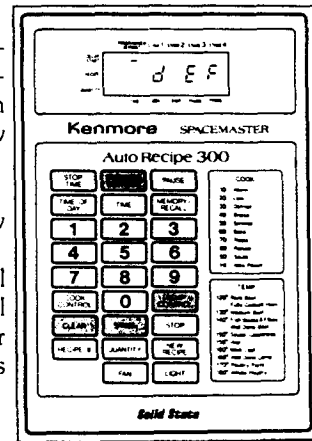

PRESET RECIPE COOKING

Auto Recipe 300 plus 3 Customer Programmable Recipes

300 recipes shown in the cookbook have been stored in this oven. By touching the recipe number corresponding to preset recipe, cooking can be done. These 300 recipes have been preset, so you can not erase or substitute them. You can program 3 more favorite recipes in Recipes # 301-303. See page 31 in this manual for programming new recipes.

•To cook one of 303 preset recipes, simply follow the steps below.

1. Touch CLEAR.
2. Touch RECIPE #.
"0" will show in the display window.
3. Touch the correct numbers of Recipe found in your Kenmore Microwave Cookbook.

Example: If you cook "French Onion Soup of Recipe # 25", touch "2" and then "5".
The display window shows "25".

Note: When you touch the numbers of Recipe # 301-303, the display window may flash, it means that no preset recipe has been stored in the oven for that recipe number.

4. Touch START
The oven will begin cooking, and the display window will show the time counting down.

Some preset cookings of "AUTO RECIPE 300" can cook up to 4th stage.

Notes:

- If "PAUSE" shows in the display window between stages, a special requirement (i.e. stirring, turning over, rotating and covering by following instructions in the cookbook) is needed.
- If "PAUSE" does not show in the display window, cooking in the stage cooking will start itself or the cooking has been completed.

Example: French Onion Soup of Recipe #25

The following program has been stored into the oven.

(Stage 1; HI, 6 minutes) (PAUSE)
(Stage 2; HI, 6 minutes) (PAUSE)
(Stage 3; HI, 1 minute) (PAUSE)
(Stage 4; HI, 8 minutes)

1. Touch RECIPE #, "2" and "5".
The light at the right of RECIPE in the display window will go on, "25" will show in the display window.

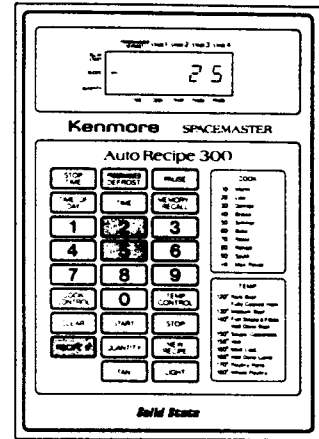

2. Touch START.
The first stage will begin. The light below STAGE 1 will go on and "600" will show in the display window. The oven will begin to cook at "HI" power level and the time will begin to count down in the display window. When the 6 minutes are over, a tone will sound and the oven will stop.

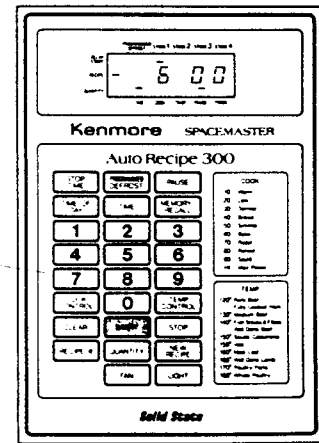

3. "PAUSE" will show in the display window.

At pause, stir by following the instructions in the cookbook.

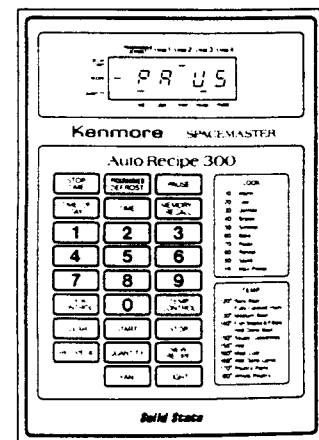

PRESET RECIPE COOKING (Cont'd)

4. Touch START.

The second stage will begin. "600" will show in the display window. The oven will begin to cook at "HI" power level and the time will begin to count down in the display window. When the 6 minutes are over, a tone will sound and the oven will stop.

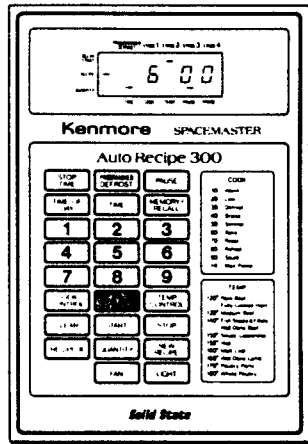

7. "PAUSE" will show in the display window.

At pause, stir in broth, wine, salt and pepper. Cover by following the instructions in the cookbook.

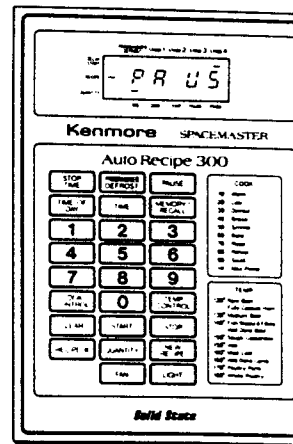

5. "PAUSE" will show in the display window.

At pause, add flour by following the instructions in the cookbook.

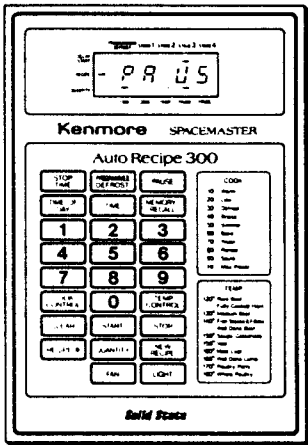

8. Touch START.

The fourth stage will begin. "800" will show in the display window. The oven will begin cooking. When the 8 minutes are over, a tone will sound and the oven will stop.

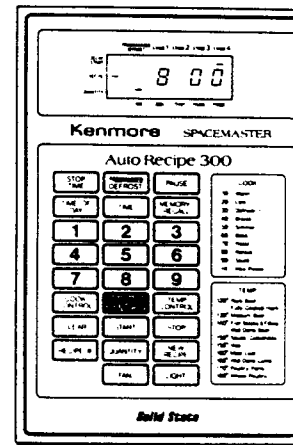

6. Touch START.

The third stage will begin. "100" will show in the display window. The oven will begin cooking. When the 1 minute is over, a tone will sound and the oven will stop.

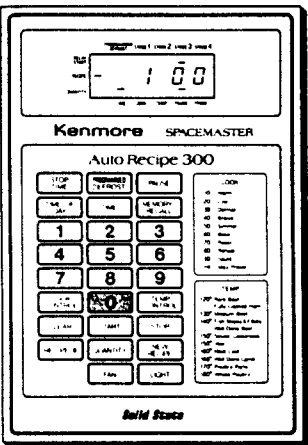

PRESET RECIPE COOKING (Cont'd)

Use of Quantity Key

- To increase Quantity of Preset Recipes.

The times, temperature and power levels for the 300 preset recipe cookings can not be changed. However the amount of food cooked in some preset recipes can be increased up to 5.9 times the Base Quantity which is preset in the oven. The light at the right of QUANTITY will turn on to indicate that you can use the QUANTITY key for that particular recipe.

To increase the quantity in these recipes, follow the steps below:

1. Touch CLEAR.
2. Touch RECIPE #.
3. Touch Numbers for the Preset Recipe.
4. Touch QUANTITY.
The light at the right of QUANTITY and "00" will show in the Display Window.
5. Touch numbers for the multiplication factor.
To double the recipe, touch "2" and "0".
To triple the recipe, touch "3" and "0".
6. Touch START.

Notes: The range of multiplication is 1.1 times to 5.9 times of the Base Quantity. Increment within the above range is 0.1.
Multiplication can be used in Recipes #, where the light at the right of QUANTITY shows in the display window.
When you set the multiplication of Base Quantity beyond the range of 1.1–5.9, the oven will not start even if you touch START.

Example: To cook three hot dogs per Recipe #49.

1. Touch CLEAR.
2. Touch RECIPE #.
3. Touch "4" and "9".
4. Touch QUANTITY.
5. Touch "3" and "0".
6. Touch START.

PROGRAMMING NEW RECIPES

In addition to the 300 preset recipes, you can program 3 more favorite recipes.

To store the desired recipes in the oven, follow these steps:

1. Touch CLEAR.
2. Touch NEW RECIPE.
"0" will show in the display window.
3. Touch RECIPE #.
4. Touch suitable numbers from 301 to 303.
Example: Touch "3", "0" and then "2".
"302" will show in the display window.
5. Preset your new recipes following the examples on pages 19 and 20.
6. Touch NEW RECIPE.
New recipe is now preset and the time of day will show in the display window.

Note: A recipe which has been stored in this manner, can be changed to a new recipe. If you want to change to a new recipe, the previously stored recipe is erased when a new recipe is entered over the old recipe.

Make a list of the recipe numbers and their recipes which are stored in this manner so that you can have easy reference for a later time.

UTENSILS

MATERIALS TO USE IN YOUR MICROWAVE OVEN

OVENPROOF GLASS

Ovenware (treated for high-intensity heat), such as utility dishes, bread dishes, pie plates, cake plates, liquid measuring cups, casseroles and bowls *without metallic trimming*.

CHINA

Bowls, cups, serving pieces, plates and platters *without metallic trimming*.

POTTERY

Dishes, cups, mugs and serving pieces *without metallic trimming*.

PLASTIC

Plastic wrap may be used as a cover. Lay the plastic wrap loosely over the dish and press it to the sides and fold back one corner for venting. The dish should be deep enough so that plastic wrap will not touch the food. As the food heats, it may cause the wrap to melt wherever it touches the food. Plastic dishes, cups, semirigid freezer containers and plastic bags are usable for short-time cooking. Use with care as some softening of the plastic may occur with heat from the food.

PAPER

Paper towels, waxed paper, paper napkins and paper plates are usable.

UTENSIL TEST: A simple way to find out if a utensil can be used for microwave cooking is to place it empty on the cooking tray. Close the door and set the time to 30 seconds (½ minute). Then touch START. If the utensil is warm to the touch at the end of this time, it should not be used for microwave cooking.

CAUTION: Always make sure that closed utensils are opened and plastic pouches of vegetables (or other food items) are pierced before cooking. Tightly closed utensils could explode.

MATERIALS TO AVOID USING IN YOUR MICROWAVE OVEN

METAL UTENSILS

Metal utensils are not recommended because the metal shields the food from microwave energy on the bottom and on the sides, causing uneven cooking results. *Metal utensils will also cause arcing and can damage the microwave oven.*

METAL DECORATION

Metal-trimmed or metal-banded dinnerware, casserole dishes, etc., should not be used. The metal trim interferes with normal cooking and may damage the dish.

CENTURA® TABLEWARE

Coming Glass does not recommend the use of its Centura® tableware or Corelle® closed handle cups for microwave cooking.

ALUMINUM FOIL

Large sheets or pieces of aluminum foil should be avoided because they will hinder cooking and *may cause harmful arcing*. However, smaller pieces may be used to cover areas such as poultry legs and wings. *Any aluminum foil used should be at least 1 inch from the side walls of oven.*

WOOD

Wooden bowls and boards will dry out when used in the microwave oven and may split or crack.

OTHER

Avoid using brown paper and cracked, flawed or chipped utensils, including ovenproof glassware.

CAUTION: Do not use metal ties on any paper or plastic bags; the ties become hot and could cause a fire.

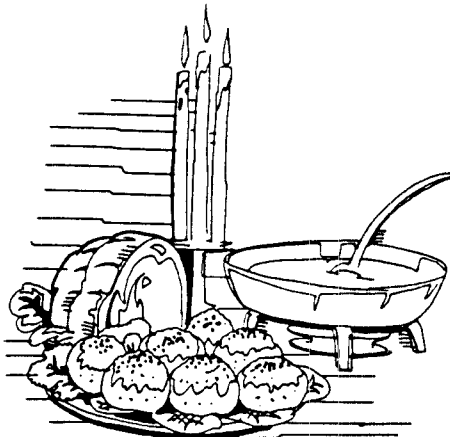

CARE AND CLEANING

Wipe the microwave inside and out, and the hood bottom cover outside with a soft cloth and a mild detergent solution. Then rinse and wipe dry. Use a chrome cleaner and polish on chrome, metal and aluminum surface. This should be done on a weekly basis-more often if needed. Never use rough cleaning powders or pads.

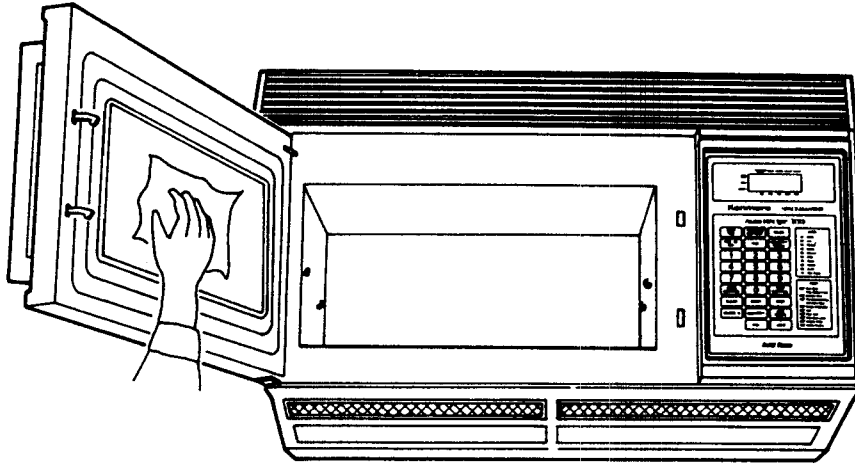

REMOVABLE PARTS

■ Temperature probe

After each use of the Temperature Probe, it must be removed from the socket. Use pot holder, as the wire, plug and sensor sections may be hot. Wipe food or liquid from sensor with damp cloth.

■ Glass tray and Metal rack

The glass tray and metal rack can be removed for cleaning at the sink. Wipe up spillovers with paper towel or cloth before removal of tray. Be careful not to chip or scratch the edges of the tray as this may cause the tray to break during use.

■ Stirrer shield

The oven inside top (stirrer shield) can be gently wiped in place or removed for washing at the sink. It rests in slots along the sides and in the rear of the oven and is held by three tabs in front. Carefully pull the front edge down and forward to remove. Wash only in warm (not hot) detergent water, rinse, and wipe dry. Avoid hitting or bending the metal stirrer blades, as this could cause uneven cooking or damage to the oven. To replace shield, slide it into the side and rear slots with cut-off at left rear corner, and carefully fit the front edge of the shield with the three tabs.

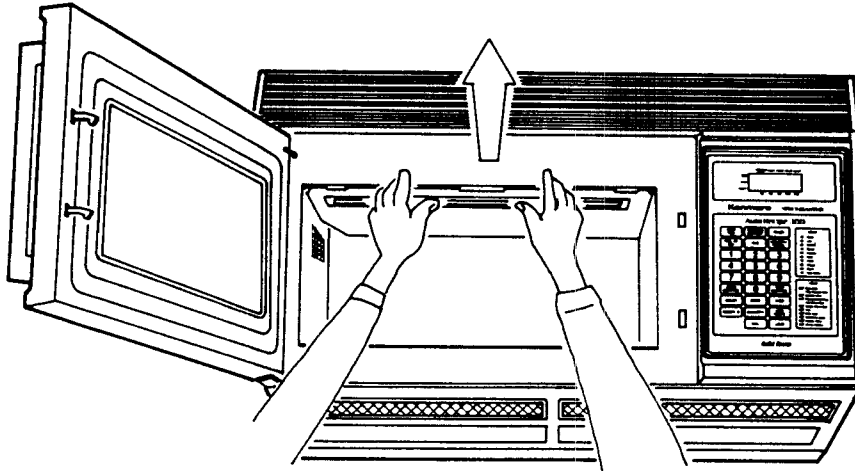

■ Exhaust filters

The two mesh exhaust filters on the hood bottom cover can be removed for washing in a sink. The filters are held by metal springs in the center of the hood bottom cover. To remove it, place a finger in the finger recess of the hood bottom cover and push it toward the center and pull down. Wash only in warm detergent water, rinse and wipe dry. Do not use ammonia for aluminum mesh filters. Do not run the hood fan without the filters.

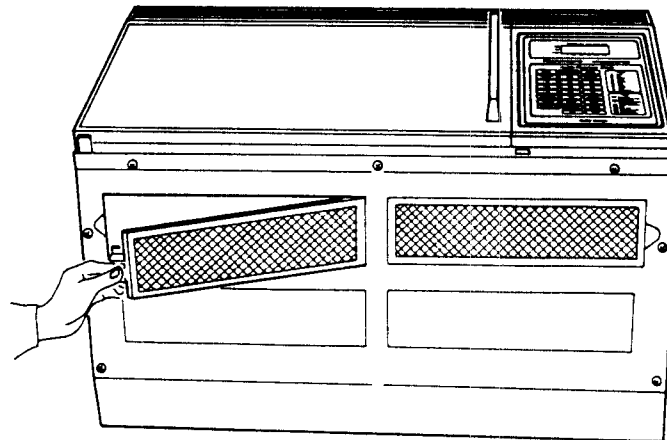

■ Charcoal filter replacement (Required when unit is not vented to outside)

The hood ventilation filters the air and discharges it back into kitchen through the Charcoal Filter. Stock No. 84126 which may be ordered at a Sears retail store or Sears catalog, if the exhaust air is not vented to the outside of house.

The Charcoal Filter behind the grillwork should be replaced every 6 to 12 months—more often if needed.

To replace the Charcoal Filter, open the door, grasp the grill work and pull it forward to remove. Slide the filter out from the filter bracket.

The used filter must be replaced with new one.

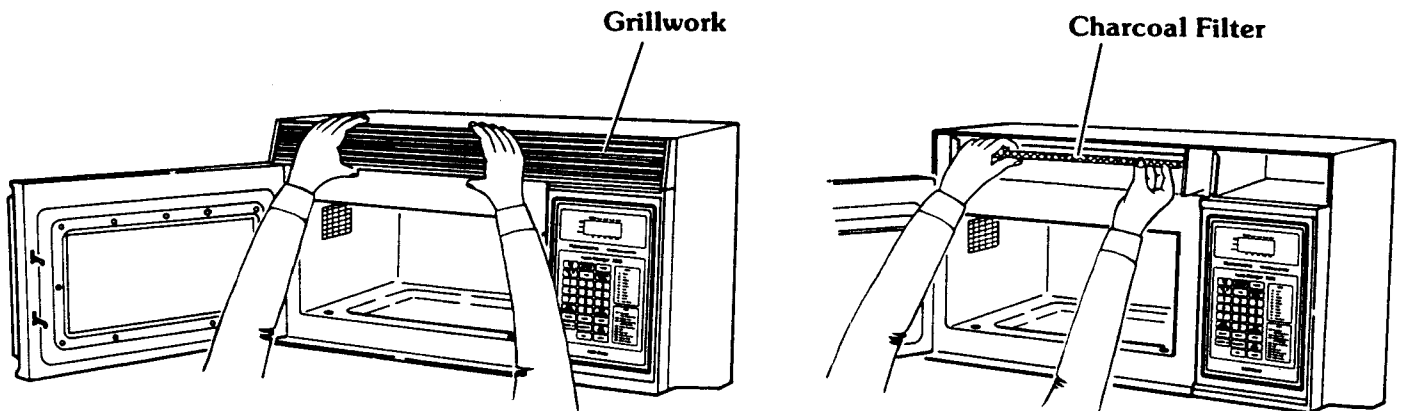

■ Work light replacement

Be sure the power is disconnected at the house circuit breaker, or by unplugging the power cord.

To replace the cooktop fluorescent lamp, the hood bottom cover must be removed.

Remove 7 screws from the front edge and the both side edges of the hood bottom cover.

To remove the lamp, hold the lamp ends, turn it about 1/4 turn and then pull it down.

The same wattage and size of the fluorescent lamp must be used for replacement.

To replace the lamp, put the lamp prongs into each socket and turn the lamp about 1/4 turn.

Put back the hood bottom cover by sliding it into the rear slots of the hood bottom cover and fastening 7 screws.

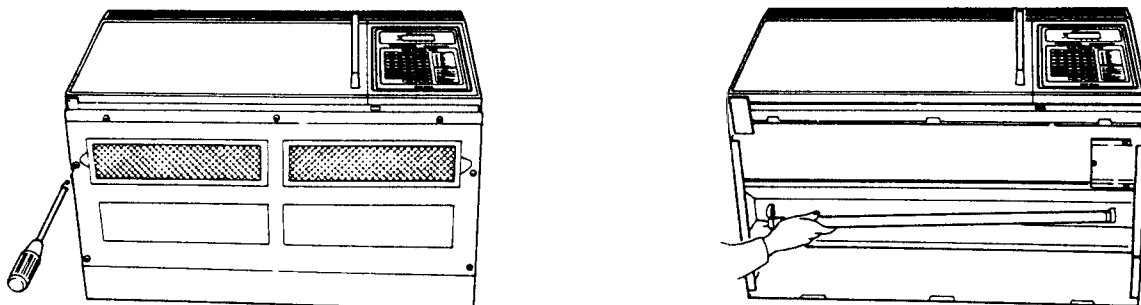

QUESTIONS AND ANSWERS

OPERATION

Q. What is wrong when the oven light will not glow during cooking or when the oven door is open?

- A. *There may be several reasons why the oven light will not glow. Perhaps:*
- *TIME has not been set.*
 - *The light bulb has burned out.*
 - *START has not been touched.*
-

Q. Why does steam come out of the grill work?

- A. *Steam is normally produced during cooking. The microwave oven has been designed to vent this steam out the grill work.*
-

Q. Will the microwave oven be damaged if it operates empty?

- A. *Yes. Never operate the oven empty or without the glass tray.*
-

Q. Does microwave energy pass through the viewing screen in the door?

- A. *No. The metal screen bounces the energy back into the oven cavity. The holes (or ports) are made to allow light to pass through. They do not let microwave energy pass through.*
-

Q. Why does the "beep tone" sound when a "pad" on the control panel is touched?

- A. *The "beep tone" sounds to assure that the setting is being properly entered.*
-

Q. Why does the display flash "0:00"?

- A. *This indicates that there has been a temporary loss of electrical power to the oven, and the TIME OF DAY must be reset.*
Prolonged loss of power can also result in loss of programmable recipes. Be sure they are recorded.
-

Q. Can my microwave oven be damaged if food is cooked for too long a period of time?

- A. *Like any other cooking appliance, it is possible to overcook food to the point of destruction which may result in the food creating smoke and even possible fire damage to the inside of the oven. It is always best to attend the oven while it is in the cooking process.*
-

Q. Why does the exhaust fan start when the FAN key is not touched?

- A. *High temperature air from the heating surface below can cause an overheating condition of the Oven, and may damage it. The exhaust fan will start automatically to cool off the oven and prevent damage to it.*
-

Q. When the oven is plugged into a wall outlet for the first time, it might not work properly. What is wrong?

- A. *Only when the oven is plugged in for the first time or when power resumes after a power interruption, the microcomputer used in the oven control assembly may temporarily become scrambled and fail to function as programmed.*
Unplug the oven from the 120-volt household outlet and then plug it back in. The microcomputer will be reset for proper function thereafter.
-

QUESTIONS AND ANSWERS (Cont'd)

FOODS

Q. What is wrong when baked foods have a hard, dry, brown spot?

A. A hard, dry, brown spot shows overcooking. Shorten the cooking or reheating time.

Q. Why do eggs sometimes pop?

A. When baking, frying or poaching eggs, the yolk may pop due to steam build-up inside the yolk membrane. To prevent this, simply pierce the yolk with a toothpick before cooking it.

CAUTION: Never microwave cook eggs in the shell.

Q. Why are scrambled eggs sometimes a little dry after cooking?

A. Eggs dry out if they are overcooked. Though the same recipe is used each time, one may need to vary the cooking time for one of these reasons:

- Eggs vary in size.
 - Eggs are at room temperature one time and at refrigerator temperature another time.
 - The shapes of utensils vary, thereby making it necessary to vary the cooking time.
 - Eggs continue cooking during standing time.
-

Q. Is it possible to pop corn in a microwave oven?

A. Popping corn in a microwave oven is not recommended. Microwaves pop too few kernels to make the technique successful. Longer cooking does not yield more popped corn. It can cause fire or cause the cooking dish to become too hot to handle or to break.

Microwave-popping devices are available. While safe to use, they usually do not give results equal to regular popping methods. If they are used, carefully follow the instructions which come with the popping device and never leave the oven unattended while popping corn.

CAUTION: Never use a paper bag for popping corn.

Q. What is wrong when three potatoes bake thoroughly and the fourth one is still not cooked?

A. The fourth potato may be slightly heavier than the others and should be cooked 30 to 60 seconds longer. Remember to allow space around each potato when baking. Also, for more even cooking, put potatoes in a circle.

Q. Why do baked apples sometimes burst during cooking?

A. The peeling has not been removed from the top half of each apple to allow for expansion of the interior of the apple during cooking. As in regular cooking methods, the interior of the apple expands during the cooking process.

Q. How are boil-overs avoided?

A. When cooking foods that tend to boil over, use a larger utensil than usual for cooking. If you open the oven door or touch STOP, the food will stop boiling. (Remember to touch START again after closing the door to restart the cooking cycle.)

Q. Why is a standing time recommended after microwave cooking is over?

A. Standing time is recommended after microwave cooking is over. This is to allow foods to continue cooking evenly throughout for a few moments after the actual microwave oven cooking cycle. The amount of standing time depends upon the density of the food.

BEFORE CALLING FOR SERVICE

You can often correct operating problems yourself. If your microwave oven fails to work properly, locate the operating problem in the chart below and try the solutions marked for each problem.

If the microwave oven still does not work properly, contact the nearest Sears Service Center. Sears Service Centers are fully equipped to handle your service requirements.

PROBLEM

| | | | | | | | | | | | | | | | | | | | | |
|-----------------------|---|---|---|---|---|---|---|--|--|--|--|--|--|--|--|--|--|--|--|--|
| Oven Will Not Start | X | X | X | X | | | | | | | | | | | | | | | | |
| Arcing or Sparking | | | | | X | X | X | | | | | | | | | | | | | |
| Time of Day Incorrect | | | | | | | | | | | | | | | | | | | | |
| Probe Light Flashes | | | | | | | | | | | | | | | | | | | | |
| Unevenly Cooked Foods | | | | | X | | | | | | | | | | | | | | | |
| Overcooked Foods | | | | | | | | | | | | | | | | | | | | |
| Undercooked Foods | | | | | X | X | | | | | | | | | | | | | | |
| Improper Defrosting | | | | | X | | | | | | | | | | | | | | | |

SOLUTION

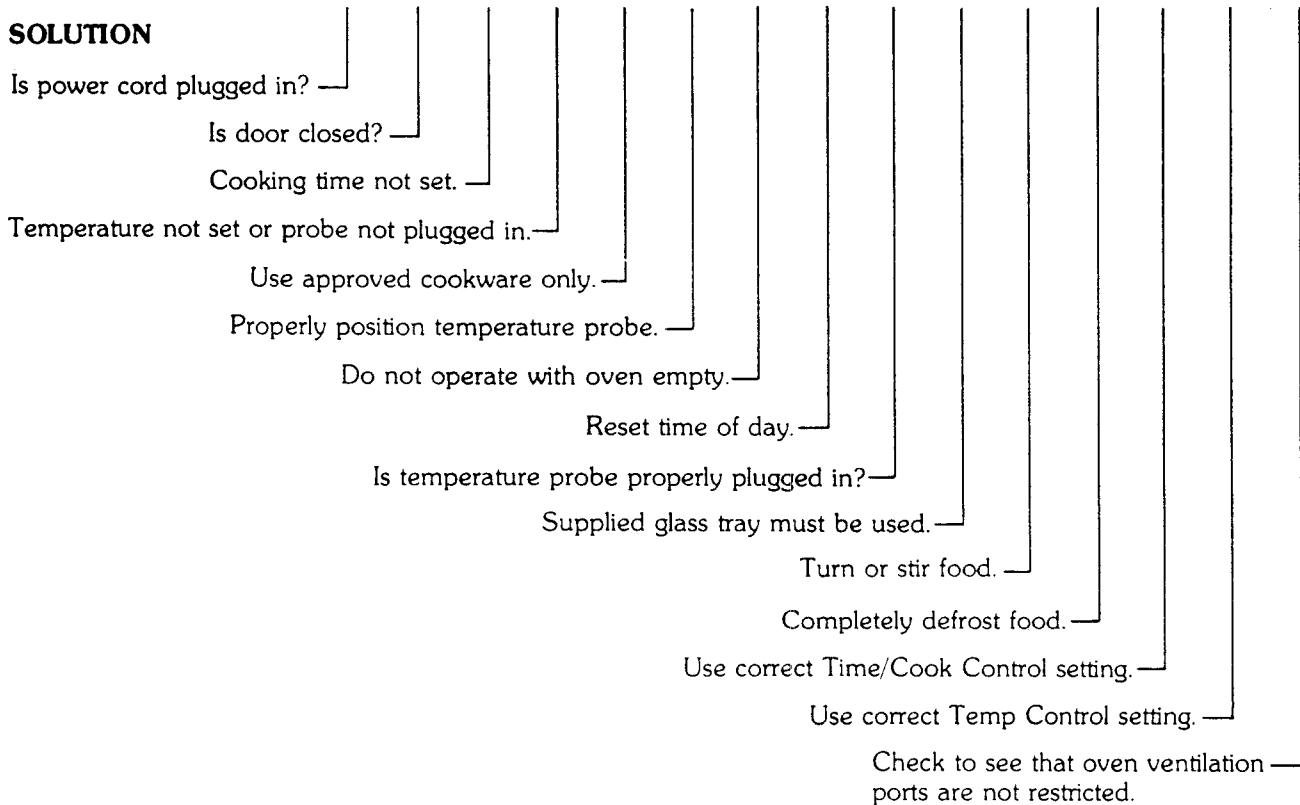

SEARS SERVICE

“WE SERVICE WHAT WE SELL”

“We Service What We Sell” is our assurance to you that you can depend on Sears for service because Sears Service is nationwide.

Your Sears Kenmore Microwave Oven has added value when you consider that Sears has a service unit near you, staffed by Sears Trained Technicians — professional technicians specifically trained on Sears Kenmore Microwave Ovens, having the parts, tools and equipment to insure that we meet our pledge to you — “We Service What We Sell!”

TO FURTHER ADD TO THE VALUE OF YOUR MICROWAVE OVEN, BUY A SEARS MAINTENANCE AGREEMENT.

Sears Kenmore Microwave Ovens are designed, manufactured, and tested for years of dependable operation. Yet, any modern appliance may require service from time to time. A Sears Maintenance Agreement is more than an extension of the Warranty.

It provides complete protection from unexpected repair bills and undue inconvenience. It assures you of maximum efficiency from your microwave oven.

Here's a comparative Warranty and Maintenance Agreement chart showing you the benefits of a Sears Microwave Oven Maintenance Agreement.

| YEARS OF OWNERSHIP COVERAGE | 1st Yr. | 2nd Yr. thru 5th Yr. |
|----------------------------------------------------------|---------|----------------------|
| 1. Replacement of defective parts other than magnetron | W | MA |
| 2. Replacement of magnetron | W | W |
| 3. Annual preventative maintenance check at your request | MA | MA |

W—WARRANTY
MA—MAINTENANCE AGREEMENT

Contact your Sears salesperson or local Sears Service Center today and purchase a Sears Maintenance Agreement.

Sears

USE & CARE
MANUAL

STOCK NO.
85941

Kenmore

MICROWAVE OVEN

WARRANTY

FULL ONE YEAR WARRANTY ON MICROWAVE OVEN

FOR ONE YEAR FROM THE DATE OF PURCHASE, IF THIS KENMORE MICROWAVE OVEN FAILS DUE TO A DEFECT IN MATERIAL OR WORKMANSHIP, SEARS WILL REPAIR IT, FREE OF CHARGE.

FULL FIVE YEAR WARRANTY ON THE MAGNETRON

FOR FIVE YEARS FROM THE DATE OF PURCHASE, IF THE MAGNETRON IN THIS KENMORE MICROWAVE OVEN FAILS DUE TO A DEFECT IN MATERIAL OR WORKMANSHIP, SEARS WILL REPAIR IT, FREE OF CHARGE.

THE ABOVE WARRANTY COVERAGE APPLIES ONLY TO MICROWAVE OVENS WHICH ARE USED FOR PRIVATE HOUSEHOLD PURPOSES.

WARRANTY SERVICE IS AVAILABLE BY SIMPLY CONTACTING THE NEAREST SEARS STORE OR SERVICE CENTER IN THE UNITED STATES.

THIS WARRANTY APPLIES ONLY WHILE THIS PRODUCT IS IN USE IN THE UNITED STATES.

THIS WARRANTY GIVES YOU SPECIFIC LEGAL RIGHTS, AND YOU MAY ALSO HAVE OTHER RIGHTS WHICH VARY FROM STATE TO STATE.

**SEARS, ROEBUCK AND CO.
DEPT. 698/731A, SEARS TOWER, CHICAGO, IL. 60684**

Sears, Roebuck and Co., Chicago, IL. 60684, U.S.A.

Sears

USE & CARE
MANUAL

STOCK NO.
85941

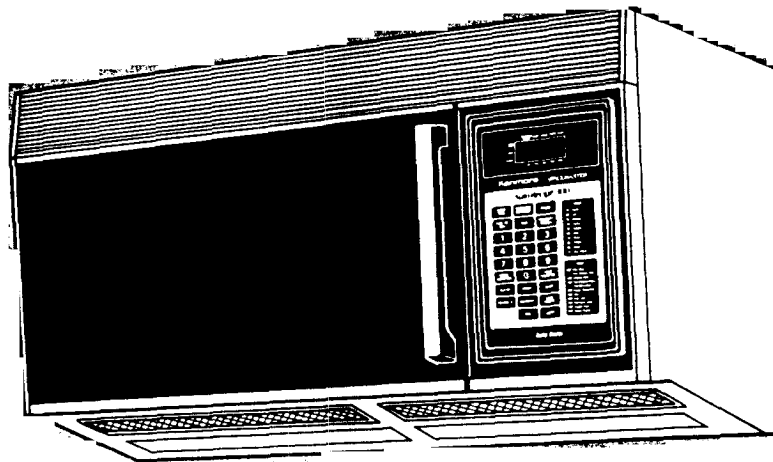

KNOW YOUR UNIT

Read this booklet so you will be able to enjoy all the features in your Kenmore Microwave Oven.

Record in space provided below the Model No. and the Serial No. found on the label on the left side of the control panel.

Model No. _____

Serial No. _____

Retain this information for future reference.

Kenmore
MICROWAVE OVEN
Use and Care

YOUR SAFETY FIRST

The Sears Kenmore Microwave Oven, though simple to use, is not a toy. Respect it as an electric cooking appliance. Become familiar with microwave energy, its uses and limitations.

PRECAUTIONS TO AVOID POSSIBLE EXPOSURE TO EXCESSIVE MICROWAVE ENERGY

- (a) DO NOT ATTEMPT to operate this oven with the door open since open-door operation can result in harmful exposure to microwave energy. It is important not to defeat or tamper with the safety interlocks.
- (b) DO NOT PLACE any object between the oven front face and the door or allow soil or cleaner residue to accumulate on sealing surfaces.
- (c) DO NOT OPERATE the oven if it is damaged. It is particularly important that the oven door closes properly and that there is no damage to the:
 - (1) DOOR (bent)
 - (2) HINGES AND LATCHES (broken or loosened)
 - (3) DOOR SEALS AND SEALING SURFACES
- (d) THE OVEN SHOULD NOT BE ADJUSTED OR REPAIRED BY ANYONE EXCEPT PROPERLY QUALIFIED SERVICE PERSONNEL.

IMPORTANT—FOR PROPER AND SAFE USE OF YOUR OVEN

- The oven must be level.
- The glass tray must be in the oven during cooking.
- The metal rack must be removed from the oven when the rack is not used for cooking.
- The oven should be thoroughly checked by a trained service technician, should it be dropped or damaged, before it is operated again.
- The electrical power cord must be kept dry and must not be pinched or crushed in any way.
- The oven has several built-in safety switches to make sure the power remains off when the door is open. DO NOT try to defeat these switches.

DON'TS

- DO NOT attempt to operate this oven with the door open.
- DO NOT run the oven empty without food in it.
- DO NOT operate the oven empty with the temperature probe plugged in.
- DO NOT run the oven empty with the Metal Rack in it.
- DO NOT use browning dishes on Metal Rack.
- DO NOT use foil or metal containers on the Metal Rack.
- DO NOT allow the temperature probe sensor to touch the sides, bottom or door of the oven when it is in use.
- DO NOT use the temperature probe in a regular oven.
- DO NOT store burnable material, such as food, in your microwave oven.
- DO NOT use this microwave oven for commercial purposes. This Sears Kenmore Microwave Oven is made for household use only.

SAFETY CERTIFICATION

The Sears Kenmore Microwave Oven is designed and thoroughly tested to meet exacting safety standards. It meets UL and FCC requirements and complies with safety performance standards of the U.S. Department of Health and Human Services.

TABLE OF CONTENTS

General Instructions

| | |
|----------------------------------------|---|
| ■ Location of Model Number Label | 4 |
| ■ Installation | 5 |
| ■ Setting “Time of Day” | 5 |
| ■ Names of Oven Parts | 6 |
| ■ Oven Control Panel | 7 |

Use Instructions

| | |
|----------------------------------------|----|
| ■ Use Instructions—Cooking Guide | 8 |
| ■ Easy Use Chart | 9 |
| ■ Recall and Change of Settings | 10 |
| ■ Pause between Stages | 10 |
| ■ Regular Timer | 10 |

Detailed Directions

| | |
|--------------------------------------------------------------------------------|------------|
| ■ “HI-Power” Cooking | 11 |
| ■ Cooking Guide for “Multi-Power” Settings | 12 |
| ■ “Multi-Power” Cooking | 13 |
| ■ “Temperature Controlled” Cooking | 14–16 |
| ■ Temperature Controlled “HI-Power” Cooking and Automatic “Hold Warm” | 17 |
| ■ Temperature Controlled “Multi-Power” Cooking and Automatic “Hold Warm” | 18 |
| ■ Two, Three or Four-Stage Cooking | 19–20 |
| ■ Delay-Start Cooking | 21 |
| ■ Whole Meal Cooking | 22 |
| ■ Programmed Defrost by Time | 23–27 |
| ■ Programmed Defrost by Temperature | 28 |
| ■ Preset Recipe Cooking | 29–31 |
| • Auto Recipe 300 | 29–30 |
| • Use of Quantity key | 31 |
| ■ Programming New Recipes | 31 |
| Utensils | 32 |
| Care and Cleaning | 33–35 |
| Questions and Answers | 36–37 |
| Before Calling for Service | 38 |
| Sears Service | 39 |
| Sears Warranty | Back Cover |

**SEARS KENMORE MICROWAVE OVEN
"USE AND CARE MANUAL"—
MICROWAVE OVEN USE INSTRUCTIONS**

Enjoy a new cooking experience from Sears. Please read this booklet. It takes only a few minutes—time well spent to learn how to use all of the features.

Advice on the use and care of Sears appliances is always available at your nearest Sears store. When seeking information, be sure you have the complete model number which is located on the plastic label. See below for its location.

MODEL NUMBER

To make a request for service, information or replacement of parts, Sears will require the complete model number of your microwave oven. The number is on the inner left side of the control panel. (You must open the door to see the number). The model number is also located on the back of the cabinet.

The number will look like this: 564.8000000.

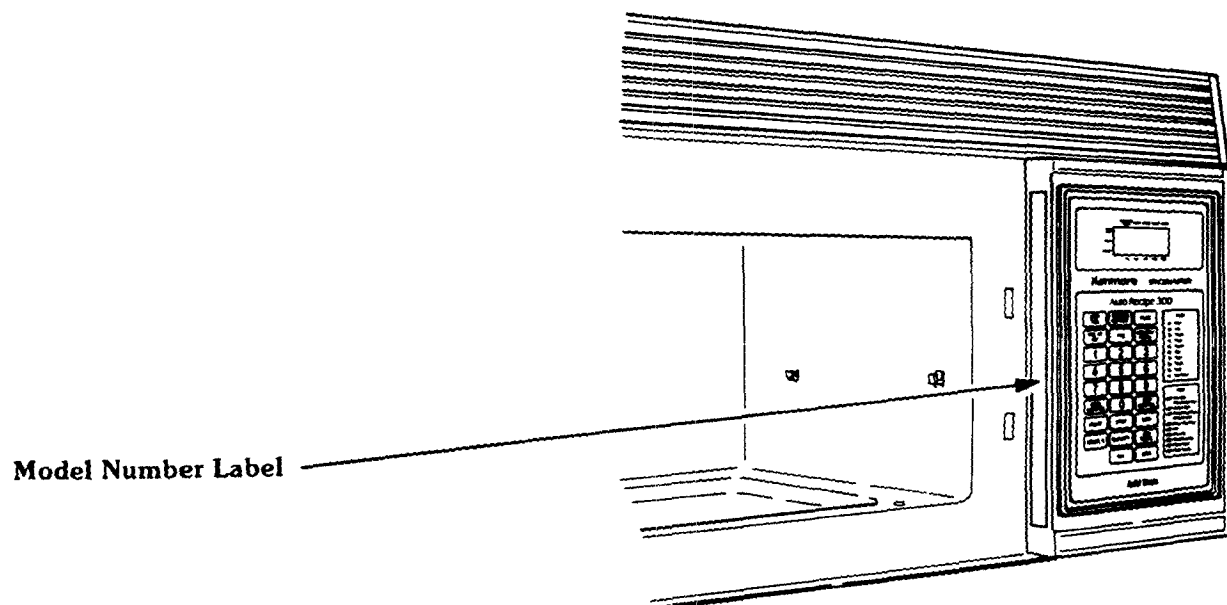

INSTALLATION

Complete Installation Instructions are included in the separate instruction manual. If you have any question on installation, please contact your Sears sales person or local Sears Service Center.

A mounting space of 33" or more from the surface of cooktop to the bottom of kitchen top cabinet, and at least 30" wide is required to mount the oven.

When the Oven is first turned on after installation, the Display Window will flash until you touch CLEAR.

Note: If your oven does not operate properly, unplug the oven from the 120-volt household outlet and then plug it back in.

SETTING TIME OF DAY

- Touch CLEAR
- Touch TIME OF DAY
- Touch numbers for correct time
- Touch TIME OF DAY

DIMENSIONS

| | |
|--------|----------|
| Height | 19-3/8" |
| Width | 29-7/8" |
| Depth | 19-1/4" |
| Weight | 106 lbs. |

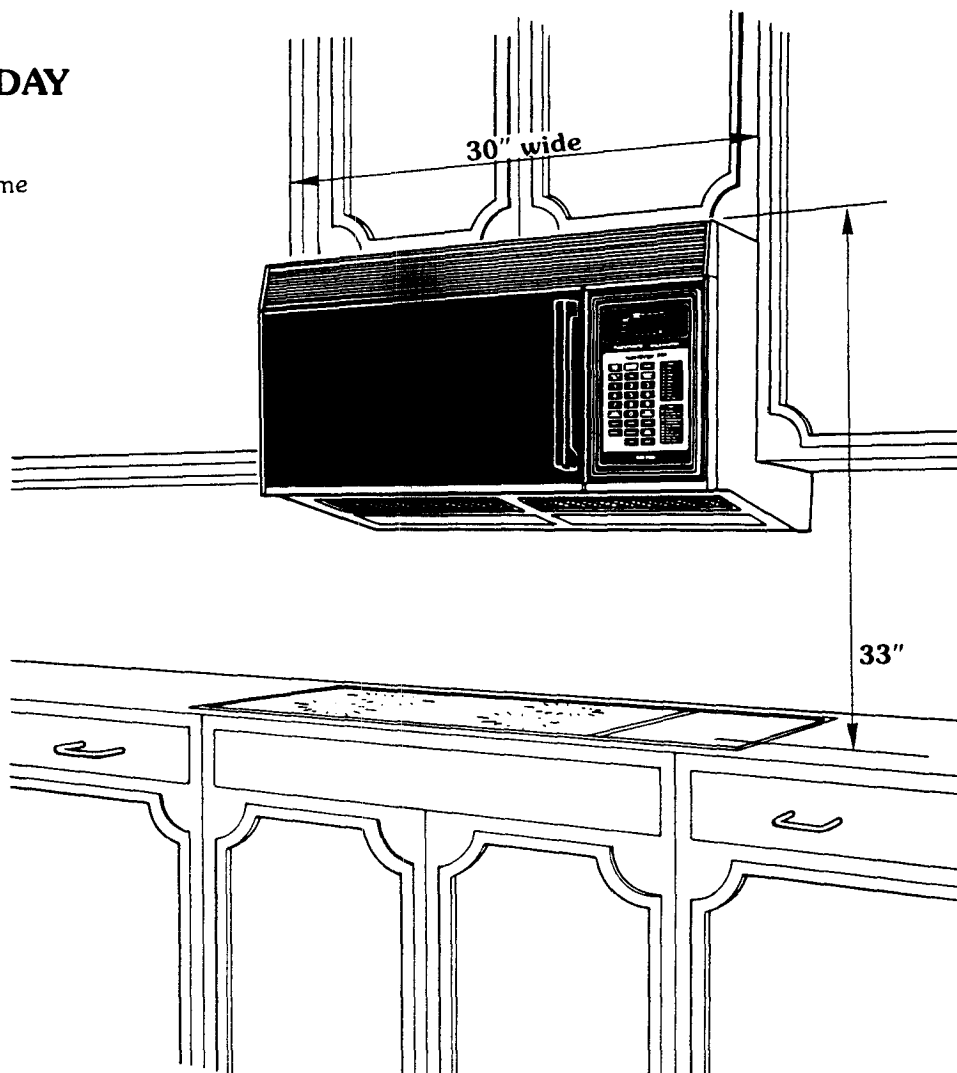

NAMES OF OVEN PARTS

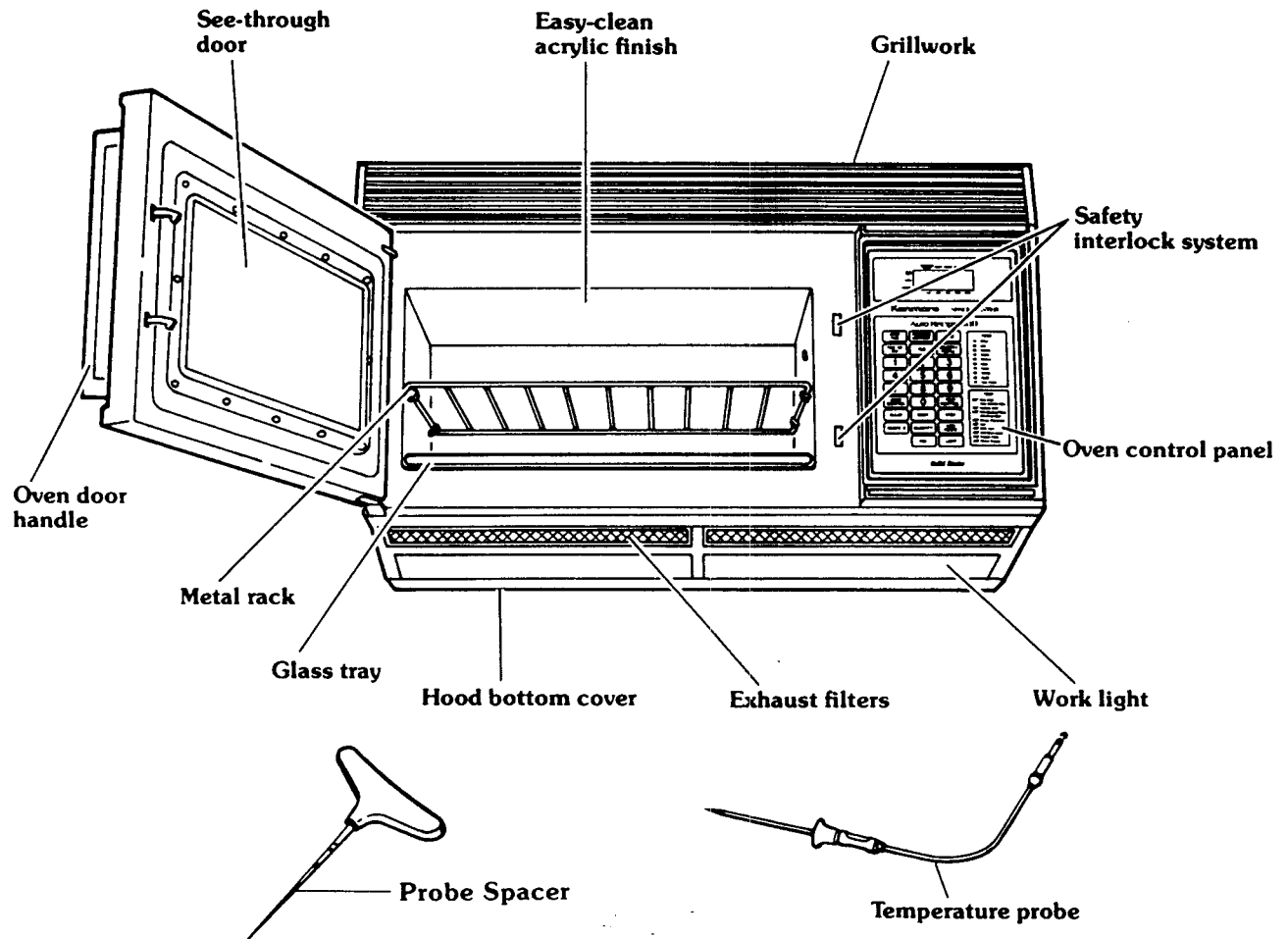

Please read "Requirements For Installation" section in Installation Manual before you remove the rest of contents from carton.

Your Oven will come with the following items.

| | |
|-------------------------------------------|--------|
| Glass Tray | 1 each |
| Metal Rack | 1 each |
| Temperature Probe | 1 each |
| Probe Spacer | 1 each |
| Cookbook | 1 each |
| Use and Care Manual | 1 each |
| Easy Use Chart Card | 1 each |
| Installation Instruction Manual | 1 each |
| Top Cabinet Template | 1 each |
| Wall Template | 1 each |
| Hardware Package | 1 each |
| Damper/Duct Connector | 1 each |

Do not use this Sears Kenmore Microwave Oven for commercial purposes. This microwave oven is made for household use only.

OVEN CONTROL PANEL

Stage Lights—When cooking stages are set, lights will go on indicating the stage in which your oven is cooking.

Indicator Lights—Time, Cook, Temp, Recipe, Delay-start and Programmed Defrost lights indicate which cooking operation is being used.

Quantity Light—When preset cooking is set light indicates that multiplication can be used in the recipe.

Programmed Defrost—Used in setting programmed defrost.

Stop Time—Used in setting a Delay-Start cooking. Cooking can be finished at the preset stop time.

Time of Day—Used in setting Time of Day.

Time—Used in setting Cooking Time.

Numbers—Used to enter the:

- Time of day.
- Delay-start time.
- Cooking times.
- Cooking powers.
- Cooking temperatures.

Cook Control—Used to select cooking power levels.

Clear—Clears all entries except TIME OF DAY. Once cooking has begun, however, CLEAR will function only after STOP has been touched.

Recipe*—Used in preset recipe cooking.

Start—Starts the oven.

Quantity—Used in multiplying base quantity of preset recipes.

Fan Control—Exhausts the air by hood fan.

Work Light—Lights up cooktop or countertop.

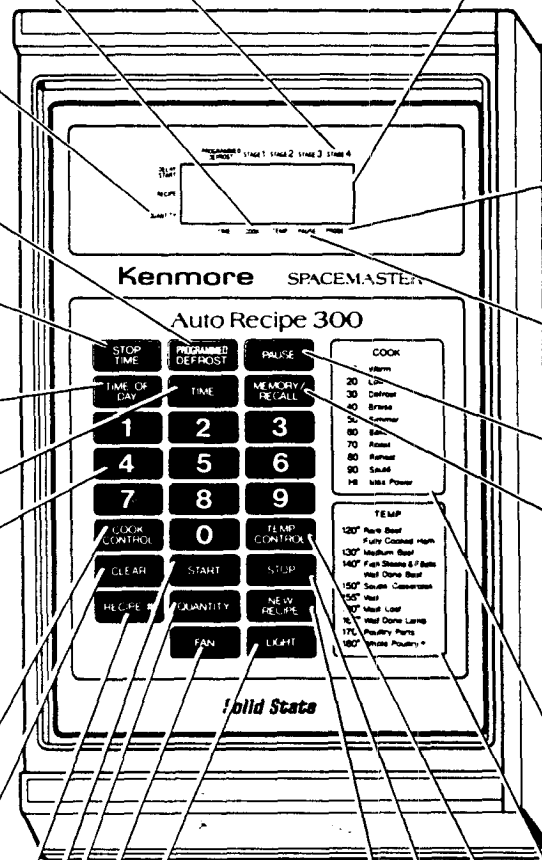

Display Window—Used to show:

- Time of day.
- Cooking time.
- Cooking power level.
- Cooking temperature.
- Hold.
- Pause (PAUS).
- Defrost (dEF).
- Recipe #.

It also functions as countdown timer or temperature indicator when cooking.

Probe Light—Flashes to warn that temperature probe is not plugged into the socket inside the oven for "Temperature Control" cooking.

Pause Light—Shows oven has been set to pause between the cooking stages.

Pause—Used to stop oven between cooking stages.

Memory/Recall—For two, three, four-stage cooking MEMORY/RECALL is used in setting:

- Cooking time.
- Power level.
- Temperature.

Also, it is used to recall each memory stage in a multiple-stage cooking program.

Cook Guide—Cooking guide which lists the types of cooking that most often occur at these cooking power levels.

Temp Guide—Temperature guide which lists the examples of food that are best cooked at these temperatures.

Temp Control—Used in setting the desired food temperature and the programmed defrost by temperature. "Temperature Control" cooking can be done only when the temperature probe is plugged into the socket inside the oven.

New Recipe—Used in programming new recipes.

Stop—Stops the oven.

NOTE: A "beep tone" sounds when a "pad" on the control panel is touched, to indicate a setting has been entered.

USE INSTRUCTIONS—COOKING GUIDE

“HI-POWER” COOKING

“HI” gives the highest power cooking possible with your microwave oven. It is the recommended setting for cooking foods with high moisture content or for cooking foods that need fast cooking to maintain their natural flavor and texture. Your *Kenmore Microwave Cooking* cookbook will tell you which foods are cooked best using the highest microwave cooking power (“HI”). For detailed directions on “HI” (maximum power) cooking, see Page 11.

“MULTI-POWER” COOKING

Many foods need slower cooking (at less than full power) in order to give the best results. In addition to “HI”, there are ninety-nine “multi-power” settings. Detailed directions for “multi-power” cooking are on Page 13.

TEMPERATURE CONTROLLED “HI-POWER” COOKING

“HI-Power” with TEMP CONTROL allows you to cook food to a preset temperature using maximum speed. Follow the directions on Page 17 and you will be able to preset the temperature you desire with the aid of the “Temperature Control” cooking guide.

TEMPERATURE CONTROLLED “MULTI-POWER” COOKING

“Multi-Power” with TEMP CONTROL allows you to cook more sensitive foods to a preset temperature by using slower microwave cooking speeds. See Page 18 for detailed directions.

AUTOMATIC “HOLD WARM”

After reaching the set temperature, the oven switches into “Hold Warm” to keep the food warm.

“Hold” will show in the display window and will continue to show for up to sixty minutes or until the door has been opened or STOP has been touched. See Pages 17 and 18.

FOUR-STAGE COOKING

Some recipes need more than one cooking stage. Many foods will cook better when cooked for a period of time at one power setting and then cooked for another period of time at a different power setting. With a cake, for example, the cookbook may recommend cooking at the “60 (Bake)” setting, followed by a period of cooking time at the “HI” setting. “Bake” allows the cake to rise gently, and then “HI” finishes the cooking cycle. You can preset up to four stages at the beginning, start the oven, and then the oven will change automatically into the second stage at the preset time. “Two, Three or Four-Stage Cooking” with both TIME and TEMP CONTROL can also be set. For detailed directions on “Two, Three or Four-Stage Cooking”, see Pages 19 and 20.

DELAY START COOKING

For those times when you must be away from the kitchen, but want dinner ready when you return, cooking can be started and finished at the time of day selected. See page 21 for detailed directions.

WHOLE MEAL COOKING

The Metal Rack increases the oven cooking space. To cook two or more different foods at one time, choose their proper places inside the oven by following the cookbook directions. See page 22.

PROGRAMMED DEFROST

Power level will automatically change for proper thawing of dense food items. See pages 23 thru 28 for detailed directions.

PRESET RECIPE COOKING — “Auto Recipe 300” and “3 Customer Programmable Recipes”

300 Recipes were developed by our cooking experts and have been preset into this oven for automatic cooking.

To use “AUTO RECIPE 300” cooking, touch RECIPE #, the numbers corresponding with the desired Recipe(s) shown in the cook-book and then START.

See pages 29 thru 31 of this Manual, as well as your Kenmore Microwave Cookbook for detailed directions.

In addition to AUTO RECIPE 300, 3 more recipes (Recipe #301—303) can be programmed by yourself for preset recipe cooking. See page 31 of this manual for detailed directions.

AUTOMATIC HOOD FAN CONTROL

The two-speed fan can be turned on by touching the FAN key. It is also automatically run at high speed by a heat sensing device. The sensing device detects overheating conditions from the heating surface below and turns on the fan to prevent damage to the oven. Once it is run by the sensing device, it can not be defeated by the FAN key. It continuously runs until the temperature of the Oven drops to a safe level.

EASY USE CHART

Your new solid state control system allows you to use your microwave oven in many ways.

| TIME OF DAY | "HI-POWER" COOKING | "MULTI-POWER" COOKING |
|----------------------------------------------------------------------------------------------------------------------------------------------------------------------------------------------------------------------------------------------------------------------------------------------------------------------------------------------------------------------------------------------------------------------------------------------------------------------------------------------------------------------------------------------------------------------|---------------------------------------------------------------------------------------------------------------------------------------------------------------------------------------------------------------------------------------------------------------------------------------------------------------------------------------------------------------------------------------------|--------------------------------------------------------------------------------------------------------------------------------------------------------------------------------------------------------------------------------------------------------------------------------------------------------------------------------------------------------------------------------------------------------------------------------------------------------------------------------------------------------------------------------------------------------------------------------------------------------------------------------------|
| <p>To set:</p> <ol style="list-style-type: none"> 1. Touch CLEAR. 2. Touch TIME OF DAY. 3. Touch numbers for correct time of day. 4. Touch TIME OF DAY.* <p>*This "locks" in the time and starts the clock running.</p> | <p>To set:</p> <ol style="list-style-type: none"> 1. Touch CLEAR. 2. Touch TIME. 3. Touch numbers for desired cooking time. 4. Touch START. <p>(See Page 11 for more detailed instructions.)</p> | <p>To set:</p> <ol style="list-style-type: none"> 1. Touch CLEAR. 2. Touch TIME. 3. Touch numbers for desired cooking time. 4. Touch COOK CONTROL. 5. Touch numbers for desired cooking power level. 6. Touch START. <p>(See Page 13 for more detailed instructions.)</p> |
| TEMPERATURE CONTROLLED "HI-POWER" COOKING | TEMPERATURE CONTROLLED "MULTI-POWER" COOKING | FOUR-STAGE COOKING |
| <p>To set:</p> <ol style="list-style-type: none"> 1. Plug in temperature probe. 2. Touch CLEAR. 3. Touch TEMP CONTROL. 4. Touch numbers for desired cooking temperature. 5. Touch START. <p>(See Page 17 for more detailed instructions.)</p> | <p>To set:</p> <ol style="list-style-type: none"> 1. Plug in temperature probe. 2. Touch CLEAR. 3. Touch TEMP CONTROL. 4. Touch numbers for desired cooking temperature. 5. Touch COOK CONTROL. 6. Touch numbers for desired cooking power level. 7. Touch START. <p>(See Page 18 for more detailed instructions.)</p> | <p>To set:</p> <ol style="list-style-type: none"> 1. Touch CLEAR. 2. Touch TIME or TEMP CONTROL. 3. Touch numbers for cooking time or temperature. 4. Touch COOK CONTROL. 5. Touch numbers for cooking power level. 6. Touch MEMORY/RECALL or PAUSE and repeat steps 2-5 to set 2nd cooking stage. 7. Touch MEMORY/RECALL or PAUSE and repeat steps 2-5 to set 3rd cooking stage. 8. Touch MEMORY/RECALL or PAUSE and repeat steps 2-5 to set 4th cooking stage. 9. Touch START. <p>(See Pages 19 and 20 for more detailed instructions.)</p> |
| DELAY START COOKING | PROGRAMMED DEFROST BY TEMPERATURE | PROGRAMMING NEW RECIPES |
| <p>To Set:</p> <ol style="list-style-type: none"> 1. Touch CLEAR. 2. Touch STOP TIME. 3. Touch Numbers for time of day to finish cooking. 4. Touch TIME. 5. Touch numbers for cooking time. 6. Touch COOK CONTROL. 7. Touch numbers for cooking power level. 8. Touch START. <p>* Three-Stage cooking can be used with Delay Start. After step 3 above, follow instructions for Four-Stage cooking beginning with step 2.</p> <p>(See Page 21 for more detailed instructions.)</p> | <p>To set:</p> <ol style="list-style-type: none"> 1. Drill food by using the Probe Spacer furnished with the oven. 2. Place Temperature Probe into hole and plug into socket. 3. Touch CLEAR. 4. Touch PROGRAMMED DEFROST. 5. Touch TEMP CONTROL. 6. Touch START. <p>(See Page 28 for more detailed instructions.)</p> | <p>To set:</p> <ol style="list-style-type: none"> 1. Touch CLEAR. 2. Touch NEW RECIPE. 3. Touch RECIPE #. 4. Touch numbers for New Recipe #. 5. Program Recipe following suitable operating instructions. 6. Touch NEW RECIPE. <p>(See Page 31 for more detailed instructions.)</p> |
| PROGRAMMED DEFROST BY TIME | PRESET RECIPE COOKING (Auto Recipe 300 & 3 Customer Programmable Recipes) | HOOD FAN CONTROL |
| <p>To set:</p> <ol style="list-style-type: none"> 1. Touch CLEAR. 2. Touch PROGRAMMED DEFROST. 3. Touch numbers for desired defrost time. 4. Touch START. <p>(See Pages 23 thru 27 for more detailed instructions.)</p> | <p>To set:</p> <ol style="list-style-type: none"> 1. Touch CLEAR. 2. Touch Recipe#. 3. Touch numbers for correct Preset Recipe#. 4. Touch START. <p>(See Pages 29 thru 31 for more detailed instructions.)</p> | <p>To set:</p> <ol style="list-style-type: none"> 1. Touch FAN once for low speed and twice for high speed. 2. Touch FAN again for turning the fan off. <p>* If over-heating of the Oven occurs, the fan will run by itself until the temperature of the Oven drops to a safe level.</p> |

RECALL AND CHANGE OF SETTINGS

To Recall a Setting

To recall (check) a setting **before you start the oven**, follow the directions below.

- To check the setting for a given stage, touch MEMORY/RECALL one or more times until the correct stage light and indicator light turns on. The set TIME or TEMP CONTROL for that stage will show in the display window.
- To check the cooking power level, touch COOK CONTROL.

To recall (check) a setting **while the oven is operating**, follow the directions below.

- To check settings while the oven is operating, touch the desired pad to recall the setting for the operating stage.
- To recall a future stage, touch STOP, follow the directions above for recalling (checking) a setting before starting the oven, and then touch START to continue cooking.
- To recall TIME OF DAY while the oven is running, touch TIME OF DAY. It will show momentarily in the display window.
- To recall Recipe number (s) while the oven is running, touch RECIPE #, and it will show momentarily in the display window.

To Change a Setting

Recall the setting to be changed by following the directions above and make the change as follows:

- Touch STOP The oven will stop cooking.
- Touch TIME Then touch "0" until only one "0" shows in the display window. Set the cooking time.
- Touch TEMPERATURE CONTROL Set cooking temperature.
- Touch COOK CONTROL Set cooking power level. To reset to "HI", set "99", maximum power.

PAUSE BETWEEN STAGES

Some recipes require stirring, turning and adding or removing of foods between stages. To set the oven to stop between stages, touch PAUSE rather than MEMORY/RECALL when setting the oven. After the pause, to restart the oven, touch START.

REGULAR TIMER

Your oven also has a timer that can be used for noncooking functions. When used as a regular timer, the oven is not running. The timer is simply counting down in seconds. For detailed instructions on using this timer, see below.

To use the regular timer feature:

1. Touch CLEAR.
2. Touch TIME.
3. Touch correct numbers for the time.
4. Touch COOK CONTROL.
5. Touch "0" (power level 0).
6. Touch START. The time will begin counting down in the display window with no cooking or heating in the oven. A tone will sound when the time is over.

"HI-POWER" COOKING

1. Touch CLEAR, and a beep tone will be heard. The CLEAR erases all previous settings.
2. Touch TIME. The lights above TIME and below STAGE 1 will go on. ("0" will show in the display window.)
3. Touch the correct numbers on the control panel to set the cooking time. The time set will show in the display window at the top of the control panel. For example:
 - To set 30 seconds, you would touch "3" and then "0".
 - To set 3 minutes, touch "3", "0" and "0".
 - To set 3½ minutes, touch "3", "3" and "0".

Remember, the timer is a digital clock that is divided into minutes and seconds. Therefore, ½ minute is equal to 30 seconds. Touch 30 and not 50 as with a calculator to indicate ½.

NOTE: It is not necessary to touch COOK CONTROL when cooking with the highest power ("HI"). However, if COOK CONTROL is touched, the light above COOK will go on and the word "HI" will show in the display window. This is to let you know that the oven will be operating on "HI" power unless a different power setting is chosen.

4. Touch START. The oven will begin cooking, and the display window will show the time counting down in seconds. A tone sounds for two seconds when the cooking time is completed. Then the oven shuts itself off.

NOTE: To stir food during cooking: open the oven door; stir or turn the food; close the oven door; and touch START. The oven will automatically continue to count down the amount of time left on the timer.

EXAMPLE: Fresh fish can be cooked quickly on "HI" (maximum power) for 6 minutes. To do this, follow these 4 simple steps:

1. Touch CLEAR.
2. Touch TIME.

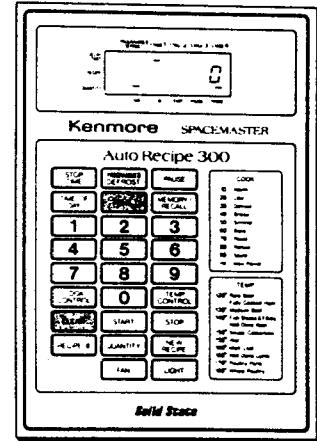

3. Set 6 minutes by touching "6", "0" and "0". "600" will show in the display window.

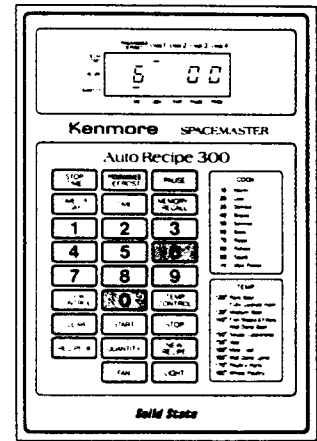

4. Touch START. The oven will begin to cook and the time will begin to count down in the display window. A tone will sound for 2 seconds when the 6 minutes are over and the oven will shut itself off.

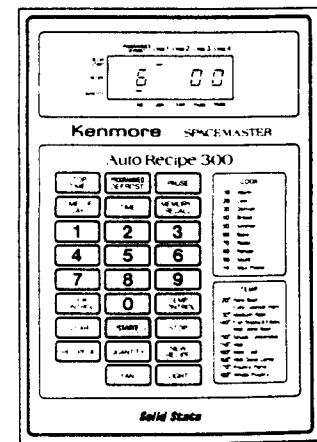

COOKING GUIDE FOR “MULTI-POWER” SETTINGS

The “Multi-Power” feature lets you cook at the best power level for the food being cooked. Cooking directions can be found in the cookbook.

| POWER LEVEL | POWER SETTINGS | EXAMPLES |
|-------------|----------------|---------------------------------------------------------------------------------------------------------------------------------------------------------------------------------------------------------------------------------------------------------------------------|
| 10 | WARM | <ul style="list-style-type: none"> • Softening cream cheese. • Keeping casseroles and main dishes warm. |
| 20 | LOW | <ul style="list-style-type: none"> • Softening chocolate. • Heating breads, rolls, pancakes, tacos, tortillas and French toast. • Clarifying butter. • Taking the chill out of fruit. • Heating small amounts of food. |
| 30 | DEFROST | <ul style="list-style-type: none"> • Thawing meat, poultry and seafood. • Completing the cooking cycle of casseroles, stews and some sauces. • Cooking small quantities of most food. |
| 40 | BRAISE | <ul style="list-style-type: none"> • Cooking less tender cuts of meat in liquid or slow cooking dishes. • Completing the cooking cycle of less tender roasts. |
| 50 | SIMMER | <ul style="list-style-type: none"> • Cooking stews and soups after bringing to a boil. • Cooking baked custards and pasta. |
| 60 | BAKE | <ul style="list-style-type: none"> • Cooking scrambled eggs. • Cooking cakes. |
| 70 | ROAST | <ul style="list-style-type: none"> • Cooking rump roast, ham, veal, and lamb. • Cooking cheese dishes. • Cooking eggs and milk. • Cooking quick breads and cereal products. |
| 80 | REHEAT | <ul style="list-style-type: none"> • Reheating precooked or prepared food quickly. • Heating sandwiches. |
| 90 | SAUTÉ | <ul style="list-style-type: none"> • Cooking onions, celery and green peppers quickly. • Reheating meat slices quickly. |
| 100 (HI) | MAX POWER | <ul style="list-style-type: none"> • Cooking tender cuts of meat. • Cooking poultry, fish, vegetables and most casseroles. • Preheating the browning dish. • Boiling water. • Thickening some sauces. |

As you get to know your microwave oven, you may find that a particular setting is too low or too high for the results you desire.

Multiple-power control gives you the means to obtain greater precision in setting power levels. For instance, if you want a power level between ROAST and REHEAT, you would set the time as usual: touch COOK CONTROL, and then touch “7” and “5”. The display window will show “75”, indicating that your oven is set to run at Power Level 75 — halfway between ROAST and REHEAT.

“MULTI-POWER” COOKING

Many foods need slower cooking (at less than full power) in order to give you the best results. In addition to “HI” there are ninety-nine multi-power settings. The cookbook tells you which power setting is recommended for the food being cooked.

To Cook with “Multi-Power”

1. Touch CLEAR.
2. Touch TIME. The lights above TIME and below STAGE 1 will go on. (“0” will show in the display window.)
3. Touch numbers for the desired cooking time. The time set will show in the display window.
4. Touch COOK CONTROL. The light above COOK will go on. Also, the word “HI” will show in the display window until a lower setting is entered. This is to tell you that the oven will be operating on “HI” power unless a different power setting is chosen.
5. Touch numbers for desired cooking power level. For example, if the recipe calls for cooking at the “20 (LOW)” setting, you would touch “2” and “0”. The display window will show “20”. This means that the oven is in a LOW setting, the oven is cooking at power level 20.
6. Touch START. The oven begins to cook and the display window will show the time counting down. A tone will sound for 2 seconds when the cooking time is over. Then the oven shuts itself off.

Example: To warm 6 doughnuts, you would cook at power level “80 (REHEAT)” for 1-1/2 minutes. To do this, follow these six steps:

1. Touch CLEAR.
2. Touch TIME.
3. Set 1-1/2 minutes by touching “1”, “3”, and then “0”. “130” will show in the display window.

4. Touch COOK CONTROL. The display window will show “HI”.

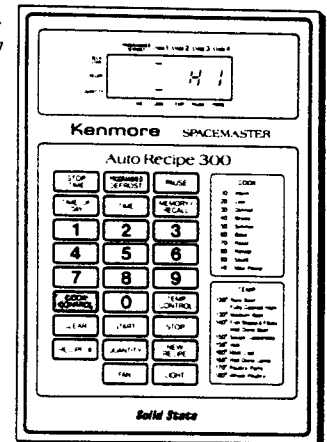

5. Choose the “80 (REHEAT)” setting by touching the numbers “8” and “0”. The display window will show “80”. This means the oven is cooking at power level 80.

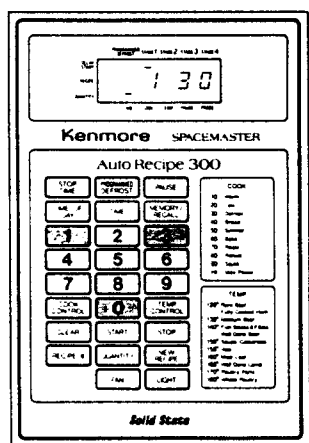
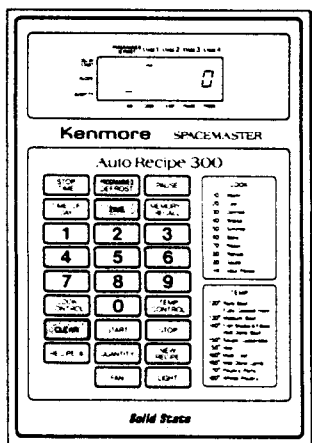
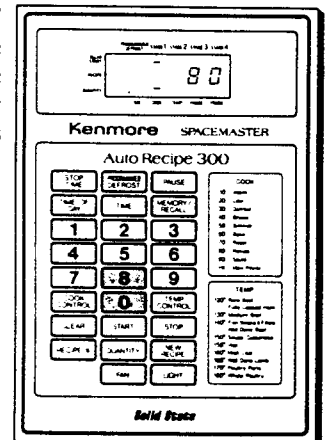

6. Touch START. The oven begins to cook and the time will begin to count down in the display window. A tone will sound for 2 seconds when the 1-1/2 minutes are over and the oven will shut itself off.

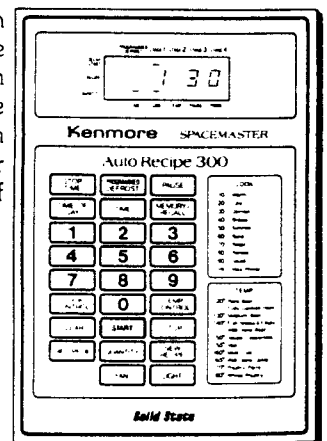

“TEMPERATURE CONTROLLED” COOKING

The temperature probe is used to judge doneness when cooking or reheating food. Set the desired food temperature with the TEMP CONTROL and the desired power level with the COOK CONTROL. When the food reaches the desired temperature, the oven will hold the food at the desired temperature up to one hour.

TEMPERATURE SETTING & DISPLAY TEMPERATURE

Temperatures from 90°F to 200°F can be chosen and set in the oven. The temperature should be set in one-degree increment.

The display window will show the rise in food temperature in one-degree increment.

The display window will not accurately show food temperature below 90°F.

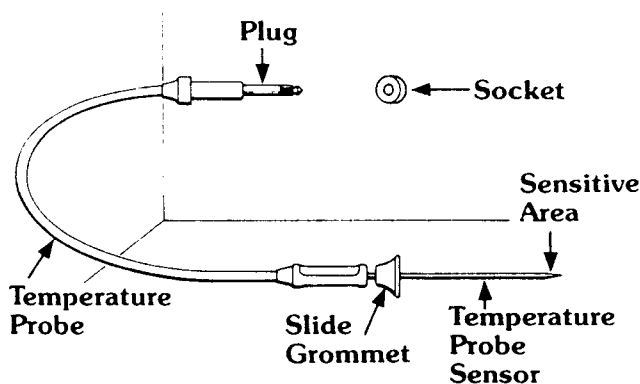

DEFINITIONS

TEMPERATURE PROBE SENSOR: The pointed metal portion of the probe which is placed into the food.

SENSITIVE AREA OF SENSOR: The first inch, or tip, of the temperature probe sensor.

PLUG: The end of the temperature probe that is plugged into the oven socket.

SOCKET: The outlet on the side of the oven wall.

CAUTION: Do not plug the pointed end of the temperature probe into the socket.

SLIDE GROMMET: Adjust the length of the temperature probe by sliding the grommet before inserting it into food so that the sensitive area of the probe can always be placed in the center of the food.

DISPLAY WINDOW: Shows the cooking temperature rising as the food is cooking. Chosen temperature may be seen during cooking by touching TEMP CONTROL. When chosen temperature is reached the display will show “Hold” for 60 minutes or until the door is opened or STOP is touched.

MEATS

- Choose only fresh, completely thawed meat.
- Place meat fat side down on the microwave roasting rack in a glass baking dish.
- Microwave cook on the first “multi-power” setting for half of the total cooking time. (See “Temperature Control” Meat Cooking Guide on Page 15.)
- Turn meat to fat side up and:

1. Place the temperature probe sensor into the meat with the first inch of the sensor in the center of the meat. The sensor should not touch the bone or fat pocket. The sensor should be put in from the side or from the front—it should not be put in from the top of the meat.
2. Plug the temperature probe into the socket on the side of the oven wall.
3. Choose the doneness temperature from the chart on Page 16. Set the temperature with the TEMP CONTROL.
4. Microwave cook the meat on the second “multi-power” setting. The microwave oven will turn itself off when the preset temperature is reached. Take the food out of the oven as soon as the display window shows “Hold”.
5. Remove the temperature sensor. Let the meat stand, covered with foil for about 10 minutes before serving. The temperature will rise about 15°F during standing time.

Note: It is normal for meats to become slightly overcooked in a small circular area in the immediate vicinity of the hole made by the meat probe.

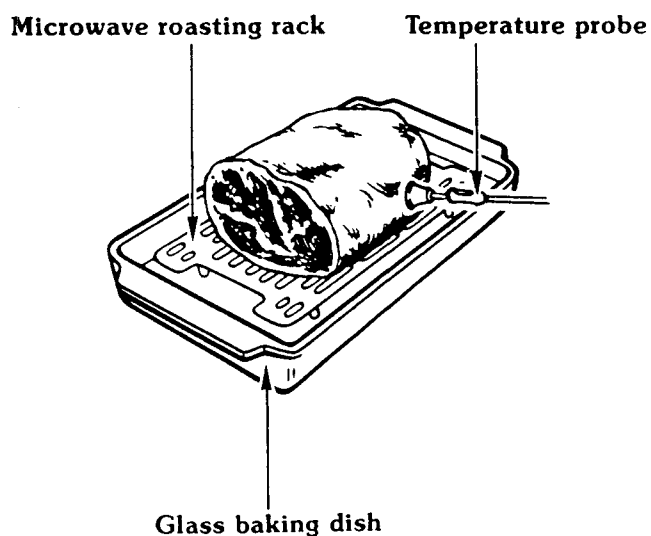

“TEMPERATURE CONTROL” POINTS TO REMEMBER

DO

- Place the temperature probe sensor into the thickest part of the meat or in the center of the food to be reheated. Avoid touching bone or fat.
- Check that the first inch of the sensor is in the densest part of the food to be cooked.
- Remove the temperature probe from the oven after use.
- Refer to cookbook for other information.

DO NOT

- Do not operate the oven while empty with the temperature probe plugged in.
- Do not let the temperature probe sensor touch the sides, bottom or door of the oven while in use.
- Do not use the temperature probe in a regular oven.
- Do not forget to turn meat between first and second settings.

“TEMPERATURE CONTROL” MEAT COOKING GUIDE

Refer to “Meats” section on Page 14.

| MEAT | FIRST SETTING AND TIME | SECOND SETTING AND TIME | TEMPERATURE PROBE AND COOK CONTROL SETTING | STANDING TIME |
|-----------------------------------------------------------|---------------------------------------------------------------------------------------------------------|----------------------------------------------------------------------------------------------------|--------------------------------------------|-------------------------------|
| BEEF Meat Loaf 2 lbs. | HI (Max. Power) 12 – 14 min. | | HI (Max. Power) 160°F | 5 – 10 min. |
| Rib Roast, boneless | HI (Max. Power) Rare 4 – 5 min. per lb. Medium 5 – 6 min. per lb. Well done 6 – 7 min. per lb. | 70 (Roast) Rare 3 – 4 min. per lb. Medium 5 – 6 min. per lb. Well done 6 – 7 min. per lb. | 70 (Roast) 120°F 130°F 140°F | 10 min. 10 min. 10 min. |
| Rib Roast, with bone | HI (Max. Power) Rare 3 – 4 min. per lb. Medium 4 – 5 min. per lb. Well done 5 – 6 min. per lb. | 70 (Roast) Rare 3 – 4 min. per lb. Medium 3 – 5 min. per lb. Well done 5 – 6 min. per lb. | 70 (Roast) 120°F 130°F 140°F | 10 min. 10 min. 10 min. |
| LAMB Lamb Leg or Shoulder Roast, with bone | 70 (Roast) Medium 4 – 5 min. per lb. Well done 5 – 6 min. per lb. | 70 (Roast) Medium 4 – 5 min. per lb. Well done 5 – 6 min. per lb. | 70 (Roast) 145°F 165°F | 5 min. 10 min. |
| Lamb Roast, Boneless | 70 (Roast) 5 – 6 min. per lb. | 70 (Roast) 5 – 6 min. per lb. | 70 (Roast) 150°F | 10 min. |
| VEAL Shoulder or Rump Roast, boneless 2 – 5 lbs. | 70 (Roast) 9 min. per lb. | 70 (Roast) 9 – 10 min. per lb. | 70 (Roast) 155°F | 10 min. |
| PORK Pork Loin Roast, boneless 3 – 5 lbs. | HI (Max. Power) 6 min. per lb. | 70 (Roast) 5 – 6 min. per lb. | 70 (Roast) 160°F | 10 min. |
| Pork Loin, center cut 4 – 5 lbs. | HI (Max. Power) 5 – 6 min. per lb. | 70 (Roast) 4 – 5 min. per lb. | 70 (Roast) 160°F | 10 min. |
| Ham, boneless, precooked | 70 (Roast) 5 – 7 min. per lb. | 70 (Roast) 5 – 7 min. per lb. | 70 (Roast) 120°F | 10 min. |
| Center Cut Ham Slice 1 – 1½ lbs. | 70 (Roast) 5 min. per lb. | 70 (Roast) 5 – 6 min. per lb. | 70 (Roast) 120°F | 10 min. |
| Smoked Ham Shank | 70 (Roast) 4 – 5 min. per lb. | 70 (Roast) 4 – 5 min. per lb. | 70 (Roast) 120°F | 10 min. |
| Canned Ham 3 lbs. | 70 (Roast) 5 – 6 min. per lb. | 70 (Roast) 5 – 6 min. per lb. | 70 (Roast) 120°F | 10 min. |
| 5 lbs. | 70 (Roast) 4 – 5 min. per lb. | 70 (Roast) 4 – 5 min. per lb. | 70 (Roast) 120°F | 10 min. |

REHEATING FOODS

- Place the temperature probe sensor into the food to be reheated with the first inch of the sensor in the center of the food.
- Plug the temperature probe into the socket on the side of the oven wall.
- Cover the food if desired.
- Set the temperature of the desired doneness. (See chart below.)
- Select “multi-power” setting as shown below.
- The microwave oven will stop cooking when the set temperature is reached and then it will “Hold Warm”.
- Remove the temperature probe from the oven after use.

“TEMPERATURE CONTROL” REHEATING GUIDE

| FOOD | SETTING | DONENESS | INSTRUCTIONS |
|-------------------------|----------------|----------|---------------------------------------------------------------------------------------------------------------------------------------------------------------------|
| Beverages | HI (MAX POWER) | 150°F | Place the temperature probe sensor in the center of the beverage glass. |
| Soups | 80 (REHEAT) | 150°F | Place the temperature probe sensor into the center of the soup. Cover with casserole lid, waxed paper, or plastic wrap. |
| Precooked Casseroles | 80 (REHEAT) | 150°F | Place temperature probe sensor into the center of the food. Cover with a casserole lid, waxed paper, or plastic wrap. |
| Canned Vegetables | 80 (REHEAT) | 150°F | Place the temperature probe sensor into the center of the food to be reheated. The sensitive area of the sensor should rest in the middle of the food. |
| Leftovers | 80 (REHEAT) | 150°F | Place the temperature probe sensor in the densest or largest amount of food. |
| Meat Sandwiches (Thick) | 80 (REHEAT) | 120°F | Place the temperature probe sensor into the thickest part of the sandwich to be warmed. The sensitive area of the sensor should be located in the sandwich filling. |
| Baked Foods | 80 (REHEAT) | 120°F | Place the temperature probe sensor into the center of the food to be reheated. The sensitive area of the sensor should rest in the middle of the food. |
| Syrup | 70 (ROAST) | 150°F | Place the temperature probe sensor into the center of the container. |

Caution: From time to time, the same kind of foods may vary in shape, form and density, and, therefore will not produce the same results each time. For this reason, we do not recommend using the temperature control settings for thin food items or for foods that require tenderiz-

ing by simmering. Also, in some cases the microwave oven may shut off prematurely. This means that either the temperature probe is not placed properly or that it should not be used with this type of food.

TEMPERATURE CONTROLLED "HI-POWER" COOKING AND AUTOMATIC "HOLD WARM"

The "Temperature Control Meat Cooking Guide" and "Reheating Guide" on Pages 15 and 16 will show you which multi-power setting and doneness temperature are recommended for the food you are cooking. When cooking with the temperature control settings, the timer is not used.

- Place the temperature probe into the food with the first inch of the sensor in the center of the food. Adjust the length of the temperature probe by sliding the grommet before inserting it into food so that the sensitive area of the probe can always be placed in the center of the meat. The probe should be in a level direction or on an angle as shown. *It should not be put in from the top.*

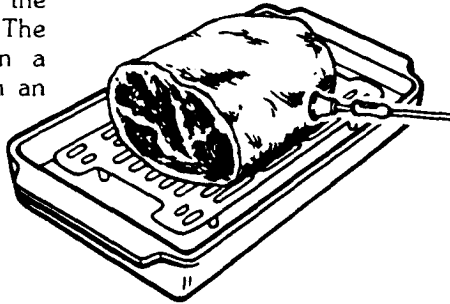

- Plug the temperature probe into the socket on the side of the oven.

Caution: Do not plug the pointed end of the temperature probe into the socket.

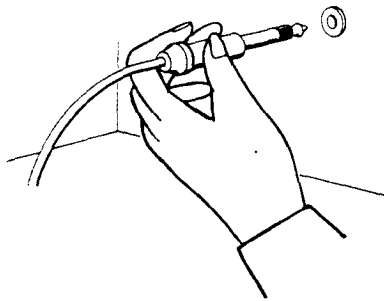

- Touch CLEAR.

- Touch TEMP CONTROL. The lights above TEMP and below STAGE 1 will go on, and "F" will show in the display window.

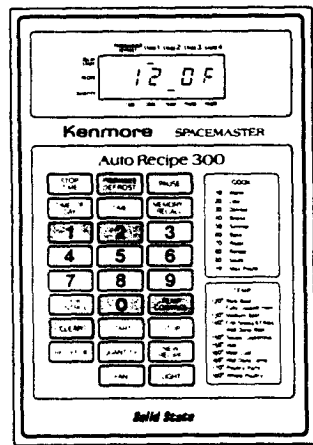

- Choose the food temperature and touch the corresponding numbers. For example, if the recipe calls for doneness at 120°F, you would touch the numbers "1", "2" and "0". When you touch "120" the display window will show "120F". If the temperature probe is not plugged into the socket, the probe light will flash and the oven will not work.

NOTE: It is not necessary to touch COOK CONTROL when you are cooking with "HI (MAX POWER)". However, if you touch COOK CONTROL the light above COOK will go on and the word "HI" will show in the display window. This is to remind you that the oven will work at "HI (MAX POWER)" unless a different power setting is chosen.

- Touch START. The oven will begin to cook and you will be able to see the temperature of the food rising in the display window. A tone will sound for one second when the desired temperature is reached.

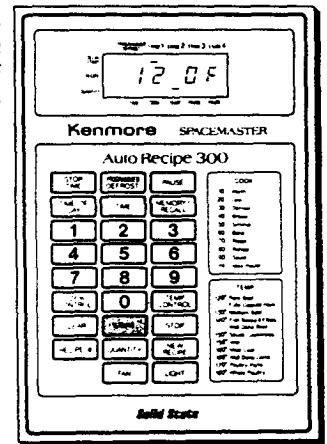

- The oven will switch into "Hold Warm" to keep the food warm. "Hold" will show in the display window. The cook control setting changes to "10 (WARM)". To check the temperature being held, touch TEMP CONTROL. The "holding" temperature will show in the display window. The "Hold Warm" will continue for 60 minutes after the food reaches the chosen temperature or until the door has been opened or until STOP has been touched. If the door is opened, the "Hold Warm" will stop. To reset, simply touch TEMP CONTROL, the corresponding numbers and START.

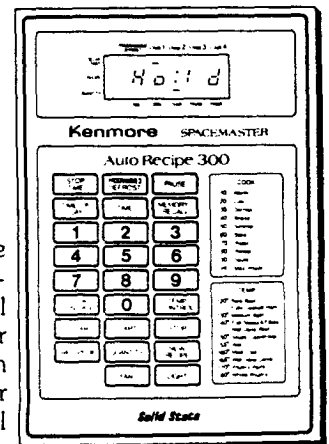

NOTE: The highest temperature to which the food may be set is 200°F. The temperature is displayed in 1°F increment.

TEMPERATURE CONTROLLED "MULTI-POWER" COOKING AND AUTOMATIC "HOLD WARM"

The "Temperature Control Meat Cooking Guide" and "Reheating Guide" on Pages 15 and 16 will show you which multi-power setting and temperature setting are recommended for the food you are cooking.

- Place the temperature probe into the food with the first inch of the sensor in the center of the food. See step 1 on page 17.
- Plug the temperature probe into the socket on the side of the oven. See step 2 on page 17.

CAUTION: Do not plug the pointed end of the temperature probe into the socket.

- Touch CLEAR.
- Touch TEMP CONTROL. The lights above TEMP and below STAGE 1 will go on, and "F" will show in the display window.

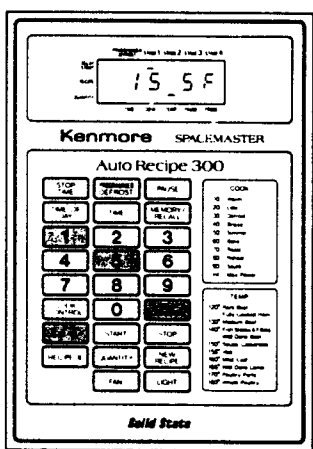

- Choose the food temperature and touch the corresponding numbers. For example, if the recipe calls for doneness at 155°F, you would touch numbers "1" "5" and "5". When you touch "155", the display window will show "155F". If the temperature probe is not plugged into the socket, the probe light will flash and the oven will not work.

- Touch COOK CONTROL. The light above COOK will go on. Also, the word "HI" will show in the display window until you enter a lower power setting. This is to remind you that the oven will always operate at full power unless you set a lower power.

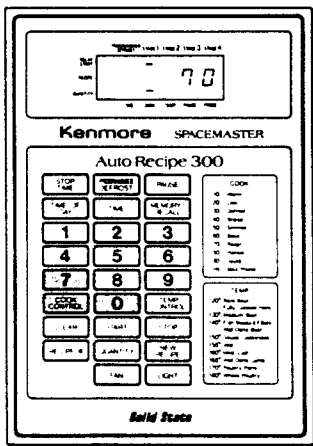

- Choose the cook control setting you desire and touch the corresponding numbers. For example, if the recipe should call for cooking at the "70 (ROAST)" setting, you would touch numbers "7" and "0". When you touch "7" and "0", the display window will show "70". This means that in the "70 (ROAST)" setting, the oven is at power level 70.

- Touch START. The oven will begin to cook and you will be able to see the temperature of the food rising in the display window.

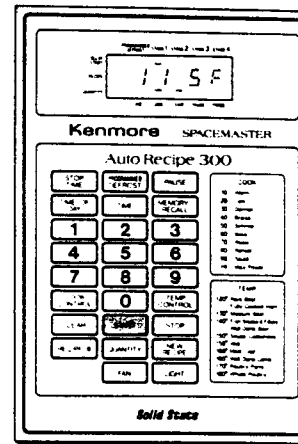

- A tone will sound for one second when the temperature is reached. The oven will switch into "Hold Warm" to keep the food warm. The cook control setting automatically changes to "10 (WARM)". The display window will show "Hold".

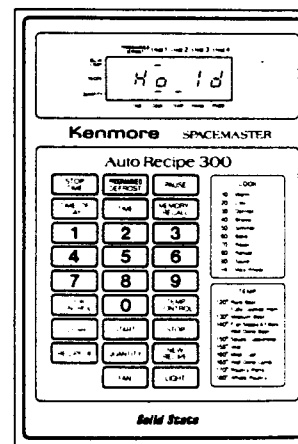

- To be sure the correct temperature is being held, you may touch TEMP CONTROL. The "holding" temperature will show in the display window. The "Hold Warm" will continue for 60 minutes after the food reaches the chosen temperature or until the door has been opened or until STOP has been touched. If the door has been opened, the "Hold Warm" will stop. To reset, simply touch TEMP CONTROL, the corresponding numbers and START.

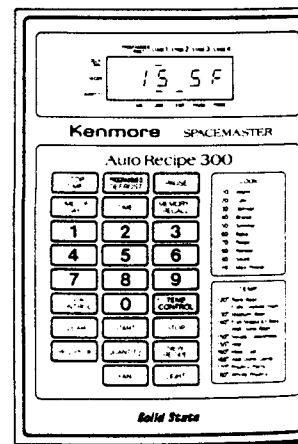

NOTE: The highest temperature that can be set is 200°F. The temperature is displayed in 1°F increment.

TWO, THREE OR FOUR-STAGE COOKING

Four-stage cooking lets you cook in four cooking stages each at a different power setting for a chosen time or temperature. Set all stages before cooking and start the oven. Simply follow these steps:

1. Touch CLEAR.
2. Touch TIME or TEMP CONTROL. The lights above TIME or TEMP and below STAGE 1 will go on. The display window will show "0" or "F".
3. Touch the correct numbers for the time or temperature of the first cooking stage.
4. Touch COOK CONTROL. The light above COOK will go on. The display window will show "HI".
5. Touch the correct numbers for the cooking power level of the first cooking stage (if other than "HI").
6. Touch MEMORY/RECALL or PAUSE. The light below STAGE 2 will go on. The display window will show "0".
7. Touch TIME or TEMP CONTROL.
8. Touch the correct numbers for the time or temperature of the second cooking stage.
9. Touch COOK CONTROL. The display window will show "HI".
10. Touch the correct numbers for the cooking power level in the second cooking stage (if other than "HI").
- 11A. Touch START for two-stage cooking.
- 11B. If three-stage or four-stage cooking is desired, touch MEMORY/RECALL or PAUSE. The light below STAGE 3 will go on. The display window will show "0".
Repeat steps 7-10 above to set the third cooking stage at the same or a different power level for a chosen time or temperature.
- 12A. Touch START for three-stage cooking.
- 12B. If four-stage cooking is desired, touch MEMORY/RECALL or PAUSE. The light below STAGE 4 will go on. The display window will show "0".
Repeat steps 7-10 above to set the fourth cooking stage at the same or a different power level for a chosen time or temperature.
13. Touch START.

EXAMPLE: (Four-stage cooking)
All-American Meat Balls
(10 minutes, power level 70) (PAUSE)
(3 minutes, power level 70) (PAUSE)
(2 minutes, power level 70)
(MEMORY/RECALL)
(5 minutes, power level 0)

The following steps explain how to set the oven.

First Stage (10 minutes; power level 70)

1. Touch CLEAR.
2. Touch TIME.
3. Set 10 minutes by touching "1", "0", "0" and "0". "1000" will show in the display window.

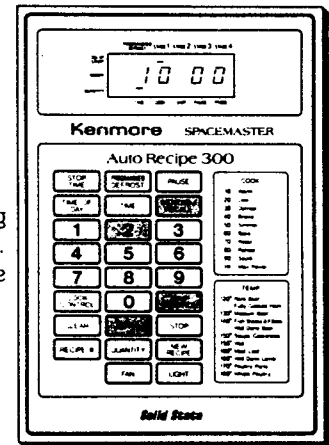

4. Touch COOK CONTROL. "HI" will show in the display window to remind you that the oven will operate at highest power unless you enter a lower power setting.
5. Touch numbers "7" and "0". "70" will show in the display window (indicating that you have set the oven to operate at power level 70). The first stage has been set.

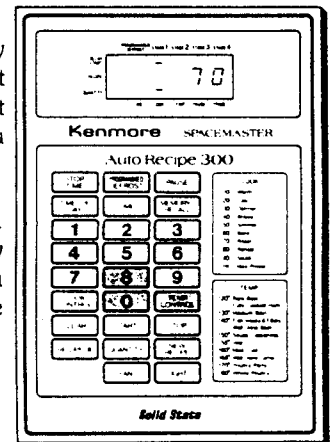

TWO, THREE OR FOUR-STAGE COOKING (Cont'd)

Second Stage (3 minutes; power level 70)

6. Touch PAUSE. The light below STAGE 2 will go on. The display window will show "0".
7. Touch TIME.
8. Set 3 minutes by touching "3", "0" and "0". "300" will show in the display window.
9. Touch COOK CONTROL and numbers "7" and "0". "70" will show in the display window. The second stage has been set.

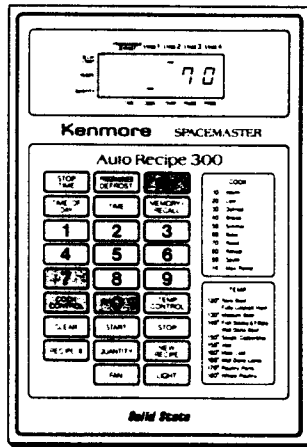

17. Touch COOK CONTROL and number "0". "0" will show in the display window. The fourth stage has been set.

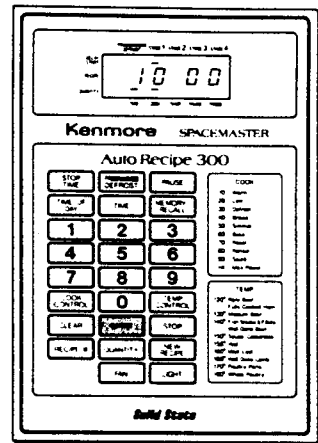

18. Touch START. The first stage will begin cooking. "1000" will show in the display window. The oven will begin to cook at a power level 70 and the time will begin to count down in the display window. When the 10 minutes are over, a tone will sound and the oven will stop. "PAUSE" will show in the display window.

Third Stage (2 minutes; power level 70)

10. Touch PAUSE. The light below STAGE 3 will go on. The display window will show "0".
11. Touch TIME.
12. Set 2 minutes by touching "2", "0" and "0". "200" will show in the display window.
13. Touch COOK CONTROL and numbers "7" and "0". "70" will show in the display window. The third stage has been set.

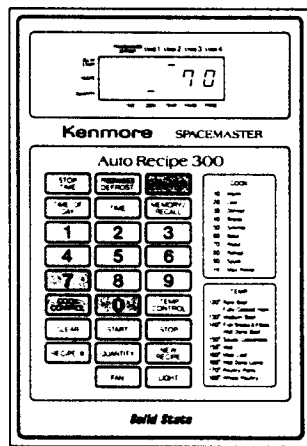

After the pause, to restart the oven, touch START for second cooking stage. "300" will show in the display window. The oven will begin to cook at "70" power level. When the 3 minutes are over, a tone will sound and the oven will stop. "PAUSE" will show in the display window.

After the pause, to restart the oven, touch START for third cooking stage. "200" will show in the display window. The oven will begin to cook at "70" power level. When 2 minutes are over, a tone will sound and the oven will change itself into the fourth stage. "500" will show the display window. When 5 minutes as "Standing time" are over, a tone will sound. The oven would have finished four stages.

Fourth Stage (5 minutes; power level 0)

14. Touch MEMORY/RECALL. The light below STAGE 4 will go on. The display window will show "0".
15. Touch TIME.
16. Set 5 minutes by touching "5", "0" and "0". "500" will show in the display window. The fourth stage has been set.

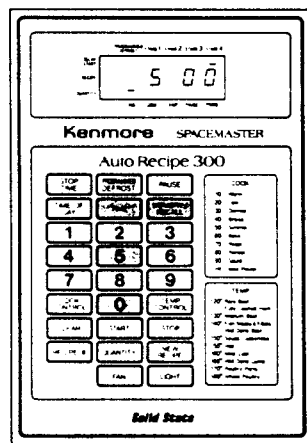

NOTES: When temperature control cooking is set in the fourth stage, the oven will switch into "Hold Warm" after cooking. The "Hold Warm" will continue for 60 minutes after the food reaches the chosen temperature or until the door has been opened or until STOP has been touched.

*"Standing time" allows the food to finish cooking and the heat to be uniform throughout. See the cookbook for detailed explanation.

If you touch MEMORY/RECALL instead of PAUSE, the oven will not stop but will remember the next stage and continue working.

DELAY START COOKING

Delay Start cooking can be done by starting the cooking automatically and finishing at a presetting delay time for the chosen cooking time.

1. Touch CLEAR.

2. Touch STOP TIME.

The light at right of DELAY START goes on. A display window will read "0:00".

3. Touch numbers for the time of day to finish cooking. For example, touch numbers "7", "3" then "0" for the cooking to be finished at "7:30", and "7:30" will show in the display window.

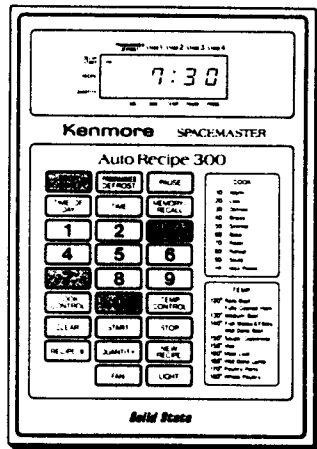

6. Touch COOK CONTROL.

7. Touch numbers for cooking power level.

For example, touch numbers "5" then "0", "50" will show in the display window.

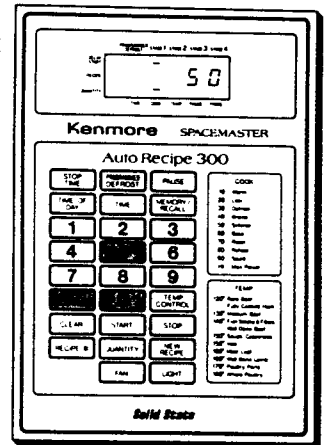

4. Touch TIME.

5. Touch numbers for cooking time.

For example, set 12 minutes by touching "1" then "2" then "0" twice. "1200" will show in the display window.

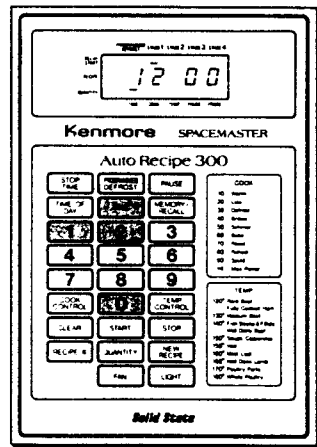

8. Touch START.

The time of day will show in the display window and the light at right of DELAY START goes on. As soon as the clock shows the Cook-Start Time which has been subtracted from the Cook-Finish Time, the oven will start cooking and the cooking time counts down in the display window. When the Cook-Finish Time (or "7:30") comes, the oven will shut itself off.

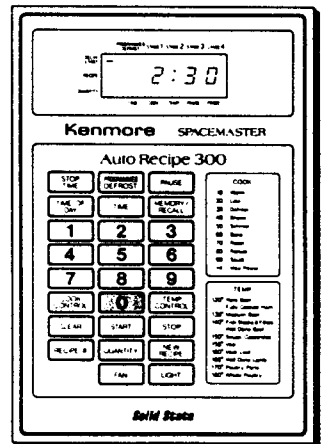

The display shows the time of day. For example: a half past two.

Note: A preset delay time must be less than 12 hours.

* Four-Stage cooking can be used with Delay Start. After step 3 above, follow instructions for Four-Stage cooking beginning with step 2.

* The Delay Start cooking is controlled by time. When "Temperature Control" cooking is set in a stage, cooking may be finished at the setting time with a slight time difference.

* Fresh food should not stand at room temperature over four hours prior to cooking.

WHOLE MEAL COOKING

(See Cookbook for detailed explanation)

Whole Metal cooking lets you cook two or more different foods at the same time. Foods need not be placed in the oven at the same time, nor be removed at the same time, unless needed. By using PAUSE rather than MEMORY/RECALL, the oven will stop between stages for time to add or remove food.

1. Place the Metal Rack in guides on the side wall of oven cavity as shown.
2. Place food into the oven.
3. Set the oven following the instructions given in the cook book.

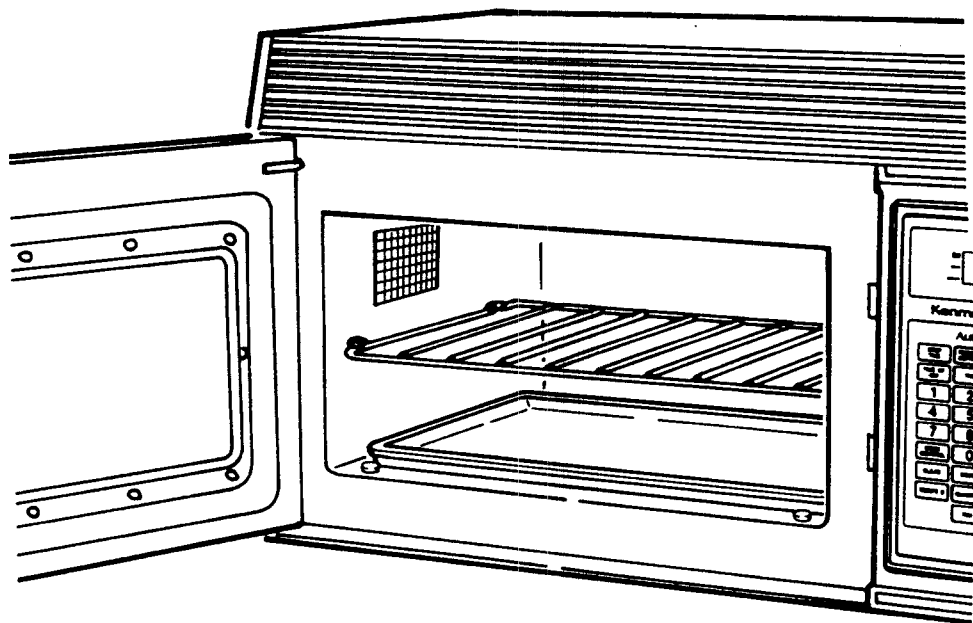

METAL RACK

- Remove Metal Rack from oven when not being used for cooking.
- Do not run the oven empty with the Metal Rack in it.
- The Metal Rack may get hot during cooking. Pot holders may be needed to remove Rack after cooking.
- Do not use browning dishes on Metal Rack.
- Do not use foil or metal containers on the Metal Rack.

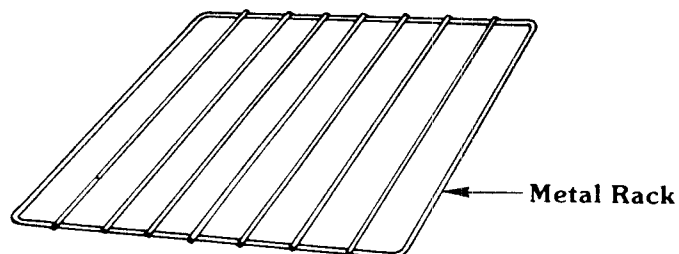

PROGRAMMED DEFROST BY TIME

The power levels for defrosting are predetermined and programmed into this oven. The oven will defrost at "HI" power for the beginning of the chosen time and at power level 30 for the remaining period of time.

1. Touch CLEAR.
2. Touch PROGRAMMED DEFROST. The light below PROGRAMMED DEFROST will go on and "0" will show in the display window.
3. Set the defrosting time by following the "Programmed Defrosting Chart" on Pages 24 through 27.
4. Touch START. The oven will begin and the time will begin counting down in the display window. A tone will sound when the time is over and the oven will shut itself off.

NOTE: If you want to cook after using the PROGRAMMED DEFROST CYCLE, touch MEMORY/RECALL, then set the standing time from chart pp. 24—27 at 0 power level; touch MEMORY/RECALL and set the time and power level for cooking the thawed food. Up to five stages can be set when PROGRAMMED DEFROST is one of the stages.

3. Set 9 minutes by touching "9", "0" and "0". "900" will show in the display window.

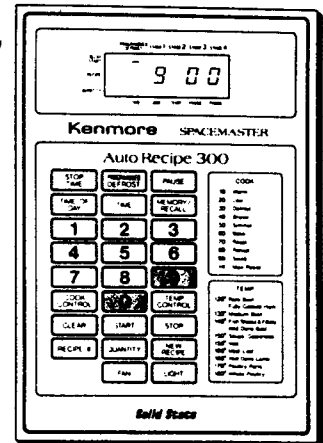

EXAMPLE: To defrost two pounds of ground beef, use the PROGRAMMED DEFROST cycle for 9 minutes.

1. Touch CLEAR.
2. Touch PROGRAMMED DEFROST. The light below PROGRAMMED DEFROST will go on. The display window will show "0".

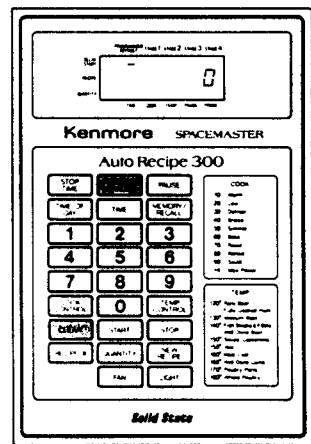

4. Touch START. The oven will begin to operate and time will begin to count down in the display window. A tone will sound when time is over and the oven will shut itself off.

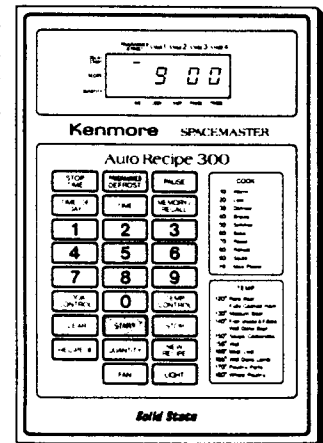

PROGRAMMED DEFROSTING CHART

The defrosting times in this chart have been made available specifically for use with the "Programmed Defrost by Time" feature.

PROGRAMMED DEFROSTING INSTRUCTIONS:

- Fish, seafood, meat or poultry can be thawed in their original closed package.
- Metal clip and pop-up timers may be left in poultry. Metal twistars must be removed from bags. They may be replaced with rubber bands.
- Place food in a flat glass baking dish to catch drippings.
- Use the "Programmed Defrost" setting to thaw fish, seafood, meat and poultry, according to the times in the chart below. Thaw completely before cooking.
- Food should still be somewhat icy in the center when removed from the oven.
- The chart gives you standing times and standing techniques needed to complete the thawing process.

IMPORTANT NOTE: The defrosting power setting (power level 30) should not be confused with this "Programmed Defrost." The defrost cooking level is a low-energy setting used to cook foods that need slow, gentle cooking. Use the defrost cooking level to reheat many frozen convenience foods and also to defrost small bread items.

| CUT AND WEIGHT | PROGRAMMED DEFROSTING TIME | STANDING TIME | DIRECTIONS |
|-----------------------------------------------|----------------------------|------------------|---------------------------------------------------------------------------------------------------------------------------------------------------------------------------------------------|
| FISH AND SEAFOOD | | | |
| FISH Fish fillets 1 lb. 2 lbs. | 4 to 5 min. 5 to 6 min. | 5 min. 5 min. | Defrost in package on dish. Carefully separate fillets under cold water. Turn over once.* |
| Fish steaks 1 lb. | 4 to 5 min. | 5 min. | Defrost in package on dish. Carefully separate steaks under cold, running water. |
| Whole Fish 8 to 10 oz. 1½ lb. to 2 lbs. | 3 to 5 min. 4 to 6 min. | 5 min. 5 min. | Use a shallow dish; the shape of the fish determines size. The fish should be icy when removed. Finish at room temperature. Cover the head with aluminum foil. Turn over once.* |
| Lobster tails 8 oz. pkg. | 4 to 6 min. | 5 min. | Remove from package to baking dish. |
| Crab legs 8 to 10 oz. | 4 to 6 min. | 5 min. | Use a glass baking dish. Break the legs apart. Turn over once.* |
| Crabmeat 6 oz. | 3 to 4 min. | 5 min. | Defrost in package on dish. Break apart. Turn over once.* |

* Turning or stirring should be done in the middle of the defrosting cycle.

PROGRAMMED DEFROSTING CHART (Cont'd)

| CUT AND WEIGHT | PROGRAMMED DEFROSTING TIME | STANDING TIME | DIRECTIONS |
|-----------------------------------------------|-----------------------------|------------------|---------------------------------------------------------------------------------------------------------------------------------------------------------|
| Shrimp 1 lb. | 2 to 3 min. | 5 min. | Remove from package to dish. Spread loosely in baking dish and rearrange during thawing as necessary. |
| Scallops 1 lb. | 7 to 9 min. | 5 min. | Defrost in package, if in block; spread out on baking dish if in pieces. Turn over and rearrange during thawing as necessary. |
| Oysters 12 oz. | 2 to 3 min. | 5 min. | Remove from package to dish. Turn over and rearrange during thawing as necessary. |
| MEAT | | | |
| BEEF Ground beef 1 lb. 2 lbs. | 4 to 4½ min. 8 to 9 min. | 5 min. 5 min. | Turn over once.* Remove thawed portions with fork. Return remainder into oven to defrost. The best way to freeze ground beef is in a doughnut shape. |
| Pot roast, chuck Under 4 lbs. | 3 to 4 min. per lb. | 10 min. | Turn over once.* |
| Rib roast, rolled 3 to 4 lbs. | 5 to 7 min. per lb. | 30-45 min. | Turn over once.* |
| Rump roast 3 to 4 lbs. | 3 to 4 min. per lb. | 30 min. | Turn over once.* |
| Round steak | 3 to 4 min. per lb. | 5-10 min. | Turn over once.* |
| Flank steak | 3 to 4 min. per lb. | 5-10 min. | Turn over once.* |
| Sirloin steak ½ inch thick | 3 to 4 min. per lb. | 5-10 min. | Turn over once.* |
| Tenderloin steak | 4 to 5 min. per lb. | 10 min. | Turn over once.* |
| Stew beef 2 lbs. | 3 to 4 min. per lb. | 8-10 min. | Turn over once.* Separate. |
| LAMB Cubed for stew | 6 to 7 min. per lb. | 5 min. | Turn over once.* Separate. |
| Ground lamb Under 4 lbs. | 3 to 4 min. per lb. | 30-45 min. | Turn over once.* |
| Chops 1 inch thick | 4 to 6 min. per lb. | 15 min. | Turn over twice.* |
| Leg 5 to 8 lbs. | 3 to 4 min. per lb. | 15-20 min. | Turn over twice.* |

* Turning or stirring should be done in the middle of the defrosting cycle.

PROGRAMMED DEFROSTING CHART (Cont'd)

| CUT AND WEIGHT | PROGRAMMED DEFROSTING TIME | STANDING TIME | DIRECTIONS |
|-------------------------------------------------|--------------------------------------------|----------------------|-------------------------------------------------------------------------------------------------|
| MEAT | | | |
| PORK Chops ½ inch thick 1 inch thick | 4 to 5 min. per lb. 5 to 6 min. per lb. | 5–10 min. 10 min. | Separate chops halfway through defrosting time. |
| Spareribs, Country-style ribs 2 to 3 lbs. | 4 to 6 min. per lb. | 10 min. | Turn over once.* |
| Roast Under 4 lbs. | 3 to 4 min. per lb. | 30–45 min. | Turn over once.* |
| Bacon 1 lb. | 1½ to 2½ min. | 3–5 min. | Defrost until strips separate. |
| Sausage, bulk 1 lb. | 1½ to 2½ min. | 3–5 min. | Turn over once.* Remove thawed portions with fork. Return remainder into oven to defrost. |
| Sausage, links 1 lb. | 2 to 4 min. | 4–6 min. | Turn over once.* Defrost until pieces can be separated. |
| Hot dogs 1 lb. | 4 to 5 min. | 5 min. | |
| VEAL Roast 3 to 4 lbs. | 4 to 6 min. per lb. | 30 min. | Turn over once.* |
| Chops ½ inch thick | 3 to 5 min. per lb. | 20 min. | Turn over once.* Separate chops and continue defrosting. |
| VARIETY MEAT Liver 1 lb. | 4 to 5 min. | 10 min. | Turn over once.* |
| Tongue 1 lb. | 6 to 7 min. | 10 min. | Turn over once.* |

* Turning or stirring should be done in the middle of the defrosting cycle.

PROGRAMMED DEFROSTING CHART (Cont'd)

| CUT AND WEIGHT | PROGRAMMED DEFROSTING TIME | STANDING TIME | DIRECTIONS |
|------------------------------------------------------------------------|-----------------------------------------------|--------------------|--------------------------------------------------------------|
| POULTRY | | | |
| Chicken Whole 2 to 3 lbs. | 5 to 7 min. per lb. | 25-30 min. | Turn over once.* Immerse in cold water for standing time. |
| Cut up 2 to 3 lbs. | 4 to 5 min. per lb. | 10-15 min. | Turn over once.* Separate pieces when partially thawed. |
| TURKEY Whole Under 8 lbs. | 3 to 4 min. per lb. | 60 min. | Turn over once.* Immerse in cold water for standing time. |
| Breast Under 4 lbs. | 3 to 4 min. per lb. | 20 min. | Turn over once.* |
| Drumsticks 1 to 1½ lbs. | 4 to 5 min. per lb. | 15-20 min. | Turn over once.* Separate pieces when partially thawed. |
| Roast, boneless 2 to 4 lbs. | 2½ to 3 min. per lb. | 10 min. | Remove from foil pan. Cover with waxed paper. |
| CORNISH HENS Whole 1. 1 to 1½ lbs. 2. 1 to 1½ lbs. ea. | 10 to 11 min. per lb. 9 to 10 min. per lb. | 20 min. 20 min. | Turn over once.* Turn over once.* |

* Turning or stirring should be done in the middle of the defrosting cycle.

PROGRAMMED DEFROST BY TEMPERATURE

Power levels for defrosting are predetermined in this oven. Thus, the temperature probe can assist in proper defrosting of large dense items, such as casseroles, poultry and roasts.

1. Cover the corners of food with small pieces of aluminum foil.

Place the food to be defrosted on a rack in a baking dish. The baking dish will collect drippings from the food while the rack will prevent the food from soaking in the drippings and will help it defrost evenly.

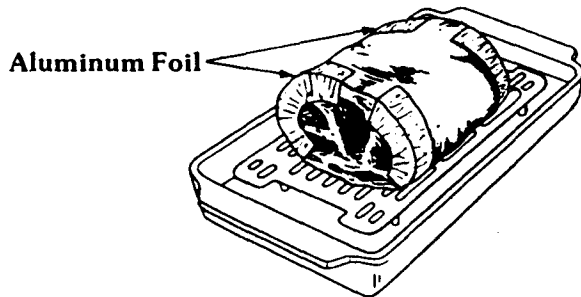

2. Adjust the slide grommet on the probe, so that the temperature probe can be placed into the food about 2-1/4" to 2-1/2" deep.

The probe should be placed horizontally about mid-height of the food and from the right-hand side. If the food is still hard and the temperature probe cannot be placed, use the probe spacer to make a 2-1/4" deep hole for the temperature probe. To avoid error, be sure the temperature probe is pushed to the bottom of the hole and do not place the temperature probe into fat, air pockets or areas near bones.

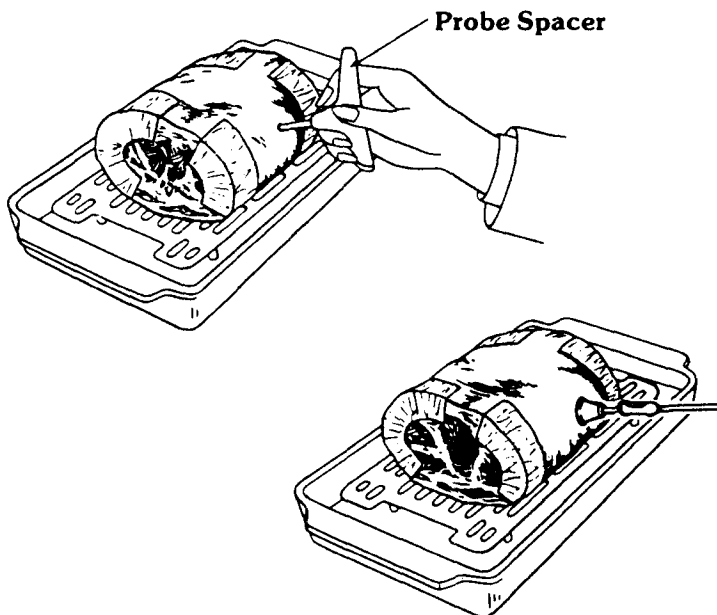

3. Plug temperature probe into socket on the side of the oven.

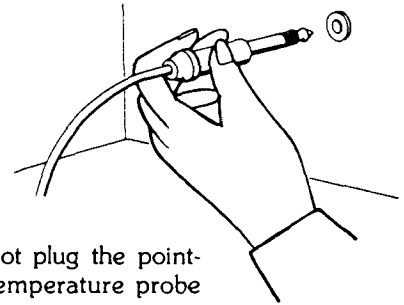

Caution: Do not plug the pointed end of the temperature probe into the socket.

4. Touch CLEAR.

5. Touch PROGRAMMED DEFROST. The light below PROGRAMMED DEFROST will go on and the display window will show "0".

6. Touch TEMP CONTROL.

The display window will show "dEF".

7. Touch START. The oven will start and the display window will show "dEF". A tone will sound for two seconds and the oven shuts itself off.

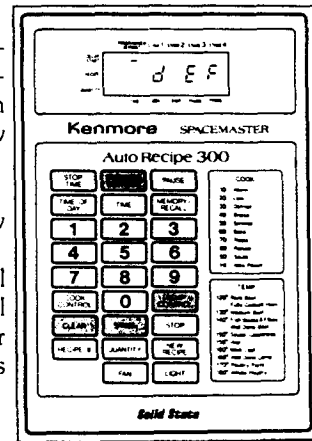

PRESET RECIPE COOKING

Auto Recipe 300 plus 3 Customer Programmable Recipes

300 recipes shown in the cookbook have been stored in this oven. By touching the recipe number corresponding to preset recipe, cooking can be done. These 300 recipes have been preset, so you can not erase or substitute them. You can program 3 more favorite recipes in Recipes # 301-303. See page 31 in this manual for programming new recipes.

•To cook one of 303 preset recipes, simply follow the steps below.

1. Touch CLEAR.
2. Touch RECIPE #.
"0" will show in the display window.
3. Touch the correct numbers of Recipe found in your Kenmore Microwave Cookbook.

Example: If you cook "French Onion Soup of Recipe # 25", touch "2" and then "5".
The display window shows "25".

Note: When you touch the numbers of Recipe # 301-303, the display window may flash, it means that no preset recipe has been stored in the oven for that recipe number.

4. Touch START
The oven will begin cooking, and the display window will show the time counting down.

Some preset cookings of "AUTO RECIPE 300" can cook up to 4th stage.

Notes:

- If "PAUSE" shows in the display window between stages, a special requirement (i.e. stirring, turning over, rotating and covering by following instructions in the cookbook) is needed.
- If "PAUSE" does not show in the display window, cooking in the stage cooking will start itself or the cooking has been completed.

Example: French Onion Soup of Recipe #25

The following program has been stored into the oven.

(Stage 1; HI, 6 minutes) (PAUSE)
(Stage 2; HI, 6 minutes) (PAUSE)
(Stage 3; HI, 1 minute) (PAUSE)
(Stage 4; HI, 8 minutes)

1. Touch RECIPE #, "2" and "5".
The light at the right of RECIPE in the display window will go on, "25" will show in the display window.

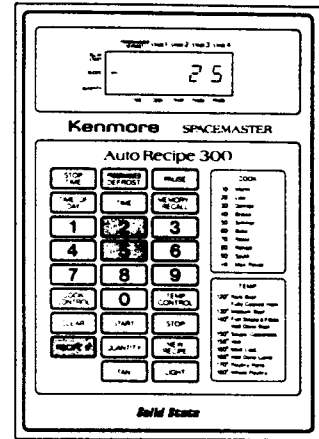

2. Touch START.
The first stage will begin. The light below STAGE 1 will go on and "600" will show in the display window. The oven will begin to cook at "HI" power level and the time will begin to count down in the display window. When the 6 minutes are over, a tone will sound and the oven will stop.

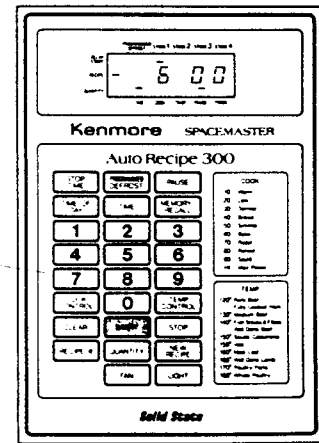

3. "PAUSE" will show in the display window.

At pause, stir by following the instructions in the cookbook.

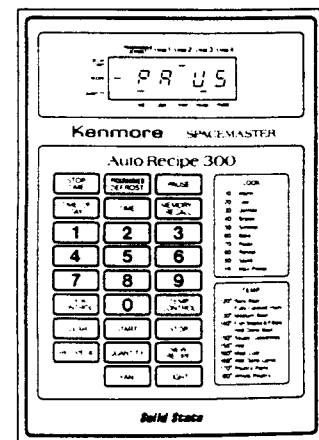

PRESET RECIPE COOKING (Cont'd)

4. Touch START.

The second stage will begin. "600" will show in the display window. The oven will begin to cook at "HI" power level and the time will begin to count down in the display window. When the 6 minutes are over, a tone will sound and the oven will stop.

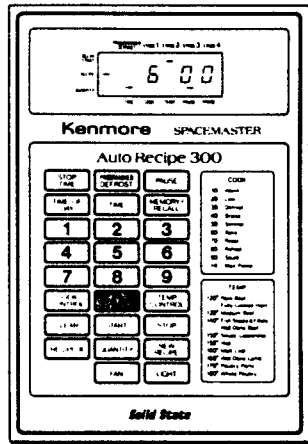

7. "PAUSE" will show in the display window.

At pause, stir in broth, wine, salt and pepper. Cover by following the instructions in the cookbook.

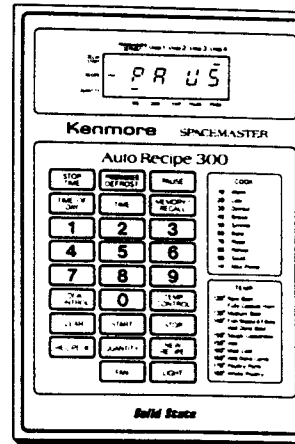

5. "PAUSE" will show in the display window.

At pause, add flour by following the instructions in the cookbook.

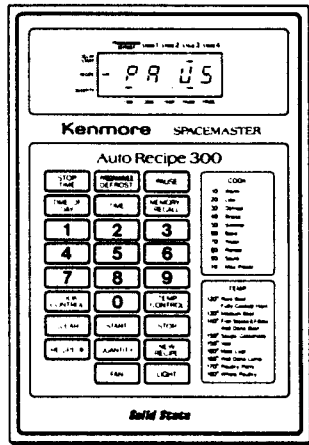

8. Touch START.

The fourth stage will begin. "800" will show in the display window. The oven will begin cooking. When the 8 minutes are over, a tone will sound and the oven will stop.

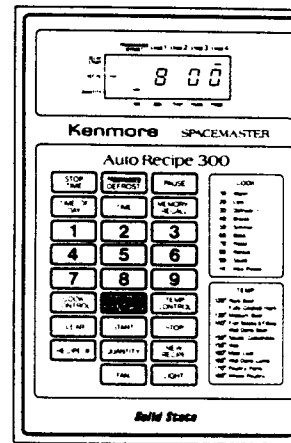

6. Touch START.

The third stage will begin. "100" will show in the display window. The oven will begin cooking. When the 1 minute is over, a tone will sound and the oven will stop.

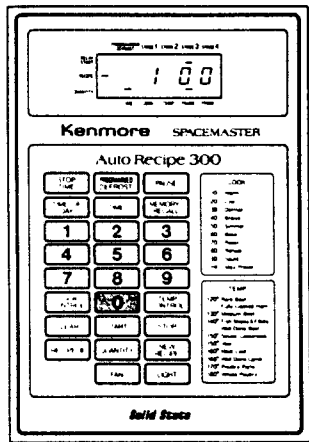

PRESET RECIPE COOKING (Cont'd)

Use of Quantity Key

- To increase Quantity of Preset Recipes.

The times, temperature and power levels for the 300 preset recipe cookings can not be changed. However the amount of food cooked in some preset recipes can be increased up to 5.9 times the Base Quantity which is preset in the oven. The light at the right of QUANTITY will turn on to indicate that you can use the QUANTITY key for that particular recipe.

To increase the quantity in these recipes, follow the steps below:

1. Touch CLEAR.
2. Touch RECIPE #.
3. Touch Numbers for the Preset Recipe.
4. Touch QUANTITY.
The light at the right of QUANTITY and "00" will show in the Display Window.
5. Touch numbers for the multiplication factor.
To double the recipe, touch "2" and "0".
To triple the recipe, touch "3" and "0".
6. Touch START.

Notes: The range of multiplication is 1.1 times to 5.9 times of the Base Quantity. Increment within the above range is 0.1.
Multiplication can be used in Recipes #, where the light at the right of QUANTITY shows in the display window.
When you set the multiplication of Base Quantity beyond the range of 1.1–5.9, the oven will not start even if you touch START.

Example: To cook three hot dogs per Recipe #49.

1. Touch CLEAR.
2. Touch RECIPE #.
3. Touch "4" and "9".
4. Touch QUANTITY.
5. Touch "3" and "0".
6. Touch START.

PROGRAMMING NEW RECIPES

In addition to the 300 preset recipes, you can program 3 more favorite recipes.

To store the desired recipes in the oven, follow these steps:

1. Touch CLEAR.
2. Touch NEW RECIPE.
"0" will show in the display window.
3. Touch RECIPE #.
4. Touch suitable numbers from 301 to 303.
Example: Touch "3", "0" and then "2".
"302" will show in the display window.
5. Preset your new recipes following the examples on pages 19 and 20.
6. Touch NEW RECIPE.
New recipe is now preset and the time of day will show in the display window.

Note: A recipe which has been stored in this manner, can be changed to a new recipe. If you want to change to a new recipe, the previously stored recipe is erased when a new recipe is entered over the old recipe.

Make a list of the recipe numbers and their recipes which are stored in this manner so that you can have easy reference for a later time.

UTENSILS

MATERIALS TO USE IN YOUR MICROWAVE OVEN

OVENPROOF GLASS

Ovenware (treated for high-intensity heat), such as utility dishes, bread dishes, pie plates, cake plates, liquid measuring cups, casseroles and bowls *without metallic trimming*.

CHINA

Bowls, cups, serving pieces, plates and platters *without metallic trimming*.

POTTERY

Dishes, cups, mugs and serving pieces *without metallic trimming*.

PLASTIC

Plastic wrap may be used as a cover. Lay the plastic wrap loosely over the dish and press it to the sides and fold back one corner for venting. The dish should be deep enough so that plastic wrap will not touch the food. As the food heats, it may cause the wrap to melt wherever it touches the food. Plastic dishes, cups, semirigid freezer containers and plastic bags are usable for short-time cooking. Use with care as some softening of the plastic may occur with heat from the food.

PAPER

Paper towels, waxed paper, paper napkins and paper plates are usable.

UTENSIL TEST: A simple way to find out if a utensil can be used for microwave cooking is to place it empty on the cooking tray. Close the door and set the time to 30 seconds (½ minute). Then touch START. If the utensil is warm to the touch at the end of this time, it should not be used for microwave cooking.

CAUTION: Always make sure that closed utensils are opened and plastic pouches of vegetables (or other food items) are pierced before cooking. Tightly closed utensils could explode.

MATERIALS TO AVOID USING IN YOUR MICROWAVE OVEN

METAL UTENSILS

Metal utensils are not recommended because the metal shields the food from microwave energy on the bottom and on the sides, causing uneven cooking results. *Metal utensils will also cause arcing and can damage the microwave oven.*

METAL DECORATION

Metal-trimmed or metal-banded dinnerware, casserole dishes, etc., should not be used. The metal trim interferes with normal cooking and may damage the dish.

CENTURA® TABLEWARE

Coming Glass does not recommend the use of its Centura® tableware or Corelle® closed handle cups for microwave cooking.

ALUMINUM FOIL

Large sheets or pieces of aluminum foil should be avoided because they will hinder cooking and *may cause harmful arcing*. However, smaller pieces may be used to cover areas such as poultry legs and wings. *Any aluminum foil used should be at least 1 inch from the side walls of oven.*

WOOD

Wooden bowls and boards will dry out when used in the microwave oven and may split or crack.

OTHER

Avoid using brown paper and cracked, flawed or chipped utensils, including ovenproof glassware.

CAUTION: Do not use metal ties on any paper or plastic bags; the ties become hot and could cause a fire.

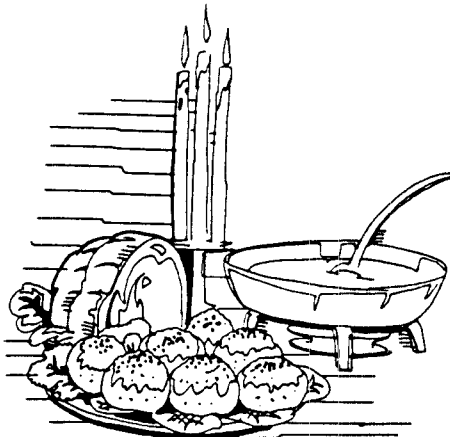

CARE AND CLEANING

Wipe the microwave inside and out, and the hood bottom cover outside with a soft cloth and a mild detergent solution. Then rinse and wipe dry. Use a chrome cleaner and polish on chrome, metal and aluminum surface. This should be done on a weekly basis-more often if needed. Never use rough cleaning powders or pads.

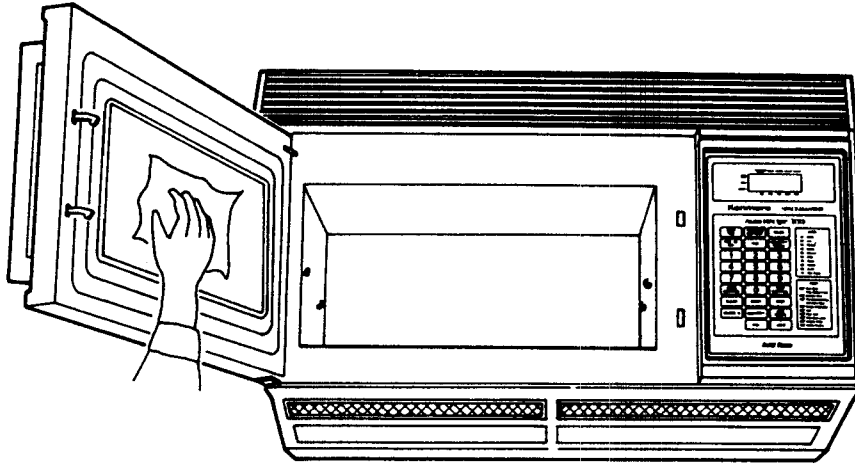

REMOVABLE PARTS

■ Temperature probe

After each use of the Temperature Probe, it must be removed from the socket. Use pot holder, as the wire, plug and sensor sections may be hot. Wipe food or liquid from sensor with damp cloth.

■ Glass tray and Metal rack

The glass tray and metal rack can be removed for cleaning at the sink. Wipe up spillovers with paper towel or cloth before removal of tray. Be careful not to chip or scratch the edges of the tray as this may cause the tray to break during use.

■ Stirrer shield

The oven inside top (stirrer shield) can be gently wiped in place or removed for washing at the sink. It rests in slots along the sides and in the rear of the oven and is held by three tabs in front. Carefully pull the front edge down and forward to remove. Wash only in warm (not hot) detergent water, rinse, and wipe dry. Avoid hitting or bending the metal stirrer blades, as this could cause uneven cooking or damage to the oven. To replace shield, slide it into the side and rear slots with cut-off at left rear corner, and carefully fit the front edge of the shield with the three tabs.

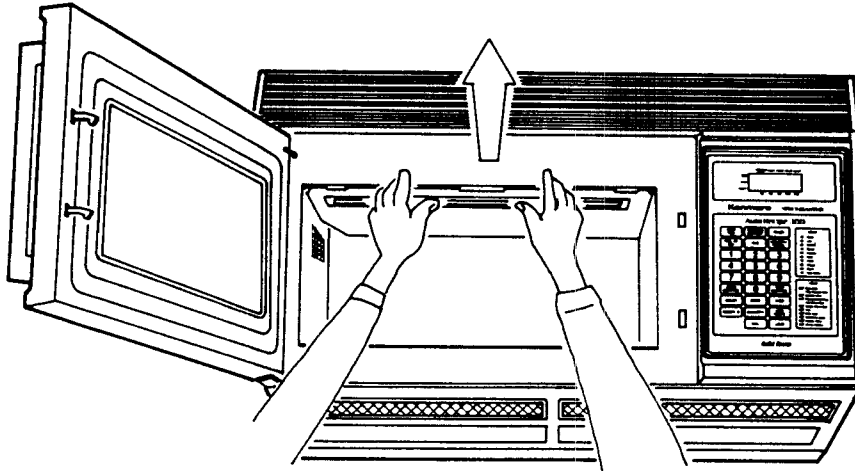

■ Exhaust filters

The two mesh exhaust filters on the hood bottom cover can be removed for washing in a sink. The filters are held by metal springs in the center of the hood bottom cover. To remove it, place a finger in the finger recess of the hood bottom cover and push it toward the center and pull down. Wash only in warm detergent water, rinse and wipe dry. Do not use ammonia for aluminum mesh filters. Do not run the hood fan without the filters.

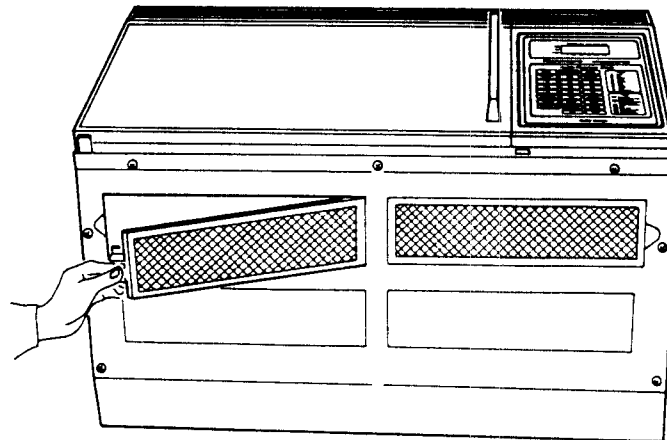

■ **Charcoal filter replacement (Required when unit is not vented to outside)**

The hood ventilation filters the air and discharges it back into kitchen through the Charcoal Filter. Stock No. 84126 which may be ordered at a Sears retail store or Sears catalog, if the exhaust air is not vented to the outside of house.

The Charcoal Filter behind the grillwork should be replaced every 6 to 12 months—more often if needed.

To replace the Charcoal Filter, open the door, grasp the grill work and pull it forward to remove. Slide the filter out from the filter bracket.

The used filter must be replaced with new one.

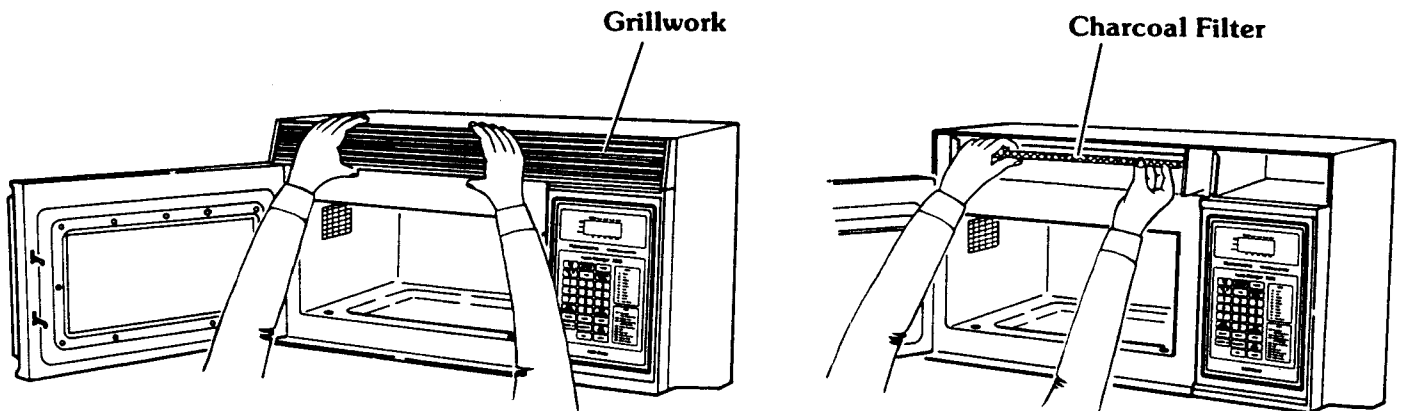

■ **Work light replacement**

Be sure the power is disconnected at the house circuit breaker, or by unplugging the power cord.

To replace the cooktop fluorescent lamp, the hood bottom cover must be removed.

Remove 7 screws from the front edge and the both side edges of the hood bottom cover.

To remove the lamp, hold the lamp ends, turn it about 1/4 turn and then pull it down.

The same wattage and size of the fluorescent lamp must be used for replacement.

To replace the lamp, put the lamp prongs into each socket and turn the lamp about 1/4 turn.

Put back the hood bottom cover by sliding it into the rear slots of the hood bottom cover and fastening 7 screws.

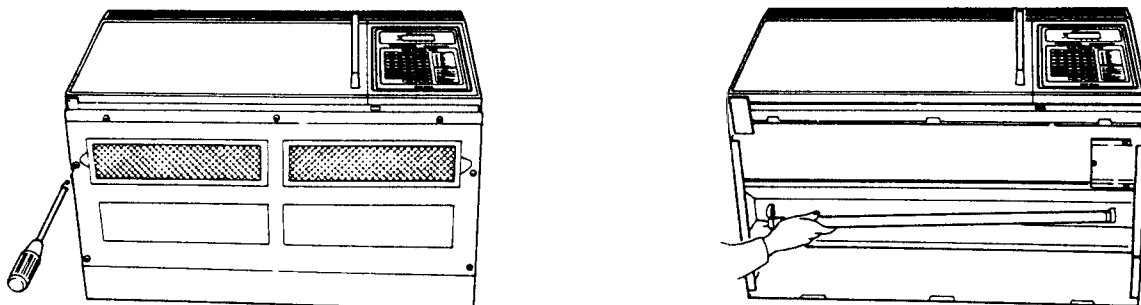

QUESTIONS AND ANSWERS

OPERATION

Q. What is wrong when the oven light will not glow during cooking or when the oven door is open?

A. *There may be several reasons why the oven light will not glow. Perhaps:*

- *TIME has not been set.*
 - *The light bulb has burned out.*
 - *START has not been touched.*
-

Q. Why does steam come out of the grill work?

A. *Steam is normally produced during cooking. The microwave oven has been designed to vent this steam out the grill work.*

Q. Will the microwave oven be damaged if it operates empty?

A. *Yes. Never operate the oven empty or without the glass tray.*

Q. Does microwave energy pass through the viewing screen in the door?

A. *No. The metal screen bounces the energy back into the oven cavity. The holes (or ports) are made to allow light to pass through. They do not let microwave energy pass through.*

Q. Why does the "beep tone" sound when a "pad" on the control panel is touched?

A. *The "beep tone" sounds to assure that the setting is being properly entered.*

Q. Why does the display flash "0:00"?

A. *This indicates that there has been a temporary loss of electrical power to the oven, and the TIME OF DAY must be reset.*

Prolonged loss of power can also result in loss of programmable recipes. Be sure they are recorded.

Q. Can my microwave oven be damaged if food is cooked for too long a period of time?

A. *Like any other cooking appliance, it is possible to overcook food to the point of destruction which may result in the food creating smoke and even possible fire damage to the inside of the oven. It is always best to attend the oven while it is in the cooking process.*

Q. Why does the exhaust fan start when the FAN key is not touched?

A. *High temperature air from the heating surface below can cause an overheating condition of the Oven, and may damage it. The exhaust fan will start automatically to cool off the oven and prevent damage to it.*

Q. When the oven is plugged into a wall outlet for the first time, it might not work properly. What is wrong?

A. *Only when the oven is plugged in for the first time or when power resumes after a power interruption, the microcomputer used in the oven control assembly may temporarily become scrambled and fail to function as programmed.*

Unplug the oven from the 120-volt household outlet and then plug it back in. The microcomputer will be reset for proper function thereafter.

QUESTIONS AND ANSWERS (Cont'd)

FOODS

Q. What is wrong when baked foods have a hard, dry, brown spot?

A. A hard, dry, brown spot shows overcooking. Shorten the cooking or reheating time.

Q. Why do eggs sometimes pop?

A. When baking, frying or poaching eggs, the yolk may pop due to steam build-up inside the yolk membrane. To prevent this, simply pierce the yolk with a toothpick before cooking it.

CAUTION: Never microwave cook eggs in the shell.

Q. Why are scrambled eggs sometimes a little dry after cooking?

A. Eggs dry out if they are overcooked. Though the same recipe is used each time, one may need to vary the cooking time for one of these reasons:

- Eggs vary in size.
 - Eggs are at room temperature one time and at refrigerator temperature another time.
 - The shapes of utensils vary, thereby making it necessary to vary the cooking time.
 - Eggs continue cooking during standing time.
-

Q. Is it possible to pop corn in a microwave oven?

A. Popping corn in a microwave oven is not recommended. Microwaves pop too few kernels to make the technique successful. Longer cooking does not yield more popped corn. It can cause fire or cause the cooking dish to become too hot to handle or to break.

Microwave-popping devices are available. While safe to use, they usually do not give results equal to regular popping methods. If they are used, carefully follow the instructions which come with the popping device and never leave the oven unattended while popping corn.

CAUTION: Never use a paper bag for popping corn.

Q. What is wrong when three potatoes bake thoroughly and the fourth one is still not cooked?

A. The fourth potato may be slightly heavier than the others and should be cooked 30 to 60 seconds longer. Remember to allow space around each potato when baking. Also, for more even cooking, put potatoes in a circle.

Q. Why do baked apples sometimes burst during cooking?

A. The peeling has not been removed from the top half of each apple to allow for expansion of the interior of the apple during cooking. As in regular cooking methods, the interior of the apple expands during the cooking process.

Q. How are boil-overs avoided?

A. When cooking foods that tend to boil over, use a larger utensil than usual for cooking. If you open the oven door or touch STOP, the food will stop boiling. (Remember to touch START again after closing the door to restart the cooking cycle.)

Q. Why is a standing time recommended after microwave cooking is over?

A. Standing time is recommended after microwave cooking is over. This is to allow foods to continue cooking evenly throughout for a few moments after the actual microwave oven cooking cycle. The amount of standing time depends upon the density of the food.

BEFORE CALLING FOR SERVICE

You can often correct operating problems yourself. If your microwave oven fails to work properly, locate the operating problem in the chart below and try the solutions marked for each problem.

If the microwave oven still does not work properly, contact the nearest Sears Service Center. Sears Service Centers are fully equipped to handle your service requirements.

PROBLEM

| | | | | | | | | | | | | | | | | | | | | | | |
|-----------------------|---|---|---|---|---|---|---|--|--|--|--|--|---|--|--|--|--|--|--|---|---|---|
| Oven Will Not Start | X | X | X | X | | | | | | | | | | | | | | | | | | |
| Arcing or Sparking | | | | | X | X | X | | | | | | | | | | | | | | | |
| Time of Day Incorrect | | | | | | | | | | | | | X | | | | | | | | | |
| Probe Light Flashes | | | | | | | | | | | | | | | | | | | | X | | |
| Unevenly Cooked Foods | | | | | X | | | | | | | | | | | | | | | X | X | X |
| Overcooked Foods | | | | | | | | | | | | | | | | | | | | X | X | |
| Undercooked Foods | | | | | X | X | | | | | | | | | | | | | | X | X | X |
| Improper Defrosting | | | | | X | | | | | | | | | | | | | | | X | X | |

SOLUTION

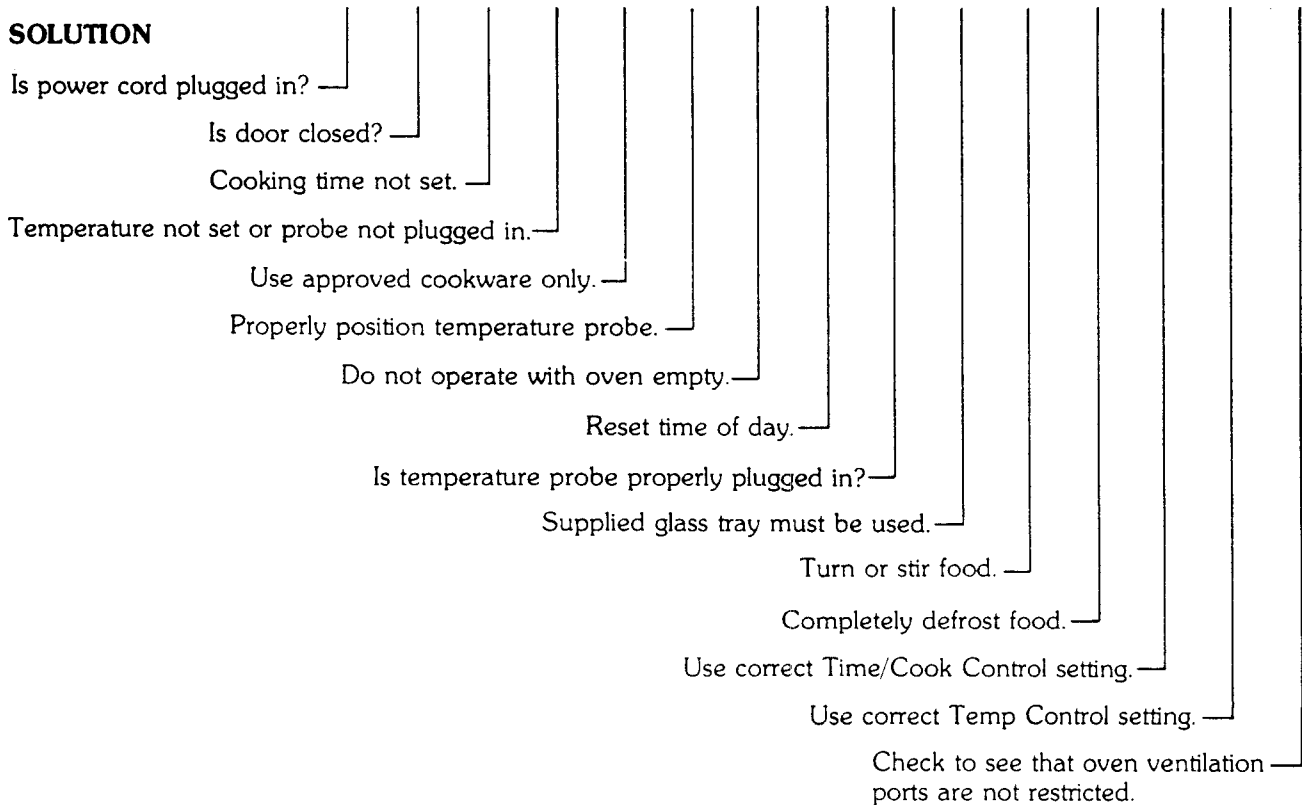

SEARS SERVICE

“WE SERVICE WHAT WE SELL”

“We Service What We Sell” is our assurance to you that you can depend on Sears for service because Sears Service is nationwide.

Your Sears Kenmore Microwave Oven has added value when you consider that Sears has a service unit near you, staffed by Sears Trained Technicians — professional technicians specifically trained on Sears Kenmore Microwave Ovens, having the parts, tools and equipment to insure that we meet our pledge to you — “We Service What We Sell!”

TO FURTHER ADD TO THE VALUE OF YOUR MICROWAVE OVEN, BUY A SEARS MAINTENANCE AGREEMENT.

Sears Kenmore Microwave Ovens are designed, manufactured, and tested for years of dependable operation. Yet, any modern appliance may require service from time to time. A Sears Maintenance Agreement is more than an extension of the Warranty.

It provides complete protection from unexpected repair bills and undue inconvenience. It assures you of maximum efficiency from your microwave oven.

Here's a comparative Warranty and Maintenance Agreement chart showing you the benefits of a Sears Microwave Oven Maintenance Agreement.

| YEARS OF OWNERSHIP COVERAGE | 1st Yr. | 2nd Yr. thru 5th Yr. |
|----------------------------------------------------------|---------|----------------------|
| 1. Replacement of defective parts other than magnetron | W | MA |
| 2. Replacement of magnetron | W | W |
| 3. Annual preventative maintenance check at your request | MA | MA |

W—WARRANTY
MA—MAINTENANCE AGREEMENT

Contact your Sears salesperson or local Sears Service Center today and purchase a Sears Maintenance Agreement.

Sears

USE & CARE
MANUAL

STOCK NO.
85941

Kenmore

MICROWAVE OVEN

WARRANTY

FULL ONE YEAR WARRANTY ON MICROWAVE OVEN

FOR ONE YEAR FROM THE DATE OF PURCHASE, IF THIS KENMORE MICROWAVE OVEN FAILS DUE TO A DEFECT IN MATERIAL OR WORKMANSHIP, SEARS WILL REPAIR IT, FREE OF CHARGE.

FULL FIVE YEAR WARRANTY ON THE MAGNETRON

FOR FIVE YEARS FROM THE DATE OF PURCHASE, IF THE MAGNETRON IN THIS KENMORE MICROWAVE OVEN FAILS DUE TO A DEFECT IN MATERIAL OR WORKMANSHIP, SEARS WILL REPAIR IT, FREE OF CHARGE.

THE ABOVE WARRANTY COVERAGE APPLIES ONLY TO MICROWAVE OVENS WHICH ARE USED FOR PRIVATE HOUSEHOLD PURPOSES.

WARRANTY SERVICE IS AVAILABLE BY SIMPLY CONTACTING THE NEAREST SEARS STORE OR SERVICE CENTER IN THE UNITED STATES.

THIS WARRANTY APPLIES ONLY WHILE THIS PRODUCT IS IN USE IN THE UNITED STATES.

THIS WARRANTY GIVES YOU SPECIFIC LEGAL RIGHTS, AND YOU MAY ALSO HAVE OTHER RIGHTS WHICH VARY FROM STATE TO STATE.

**SEARS, ROEBUCK AND CO.
DEPT. 698/731A, SEARS TOWER, CHICAGO, IL. 60684**

Sears, Roebuck and Co., Chicago, IL. 60684, U.S.A.

Sears

USE & CARE
MANUAL

STOCK NO.
85941

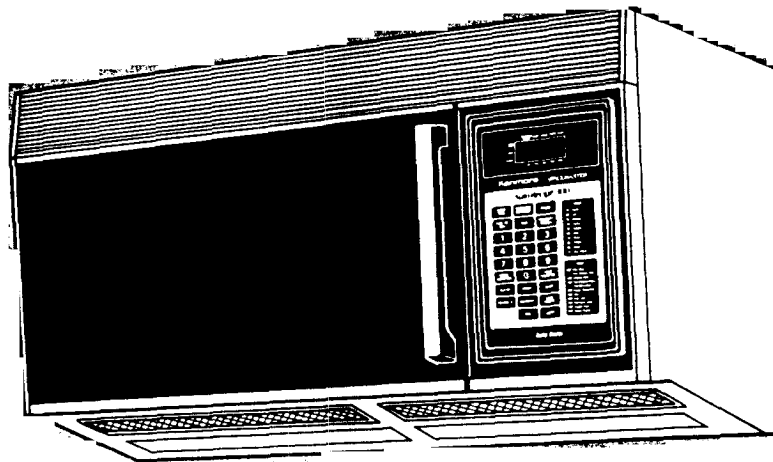

KNOW YOUR UNIT

Read this booklet so you will be able to enjoy all the features in your Kenmore Microwave Oven.

Record in space provided below the Model No. and the Serial No. found on the label on the left side of the control panel.

Model No. _____

Serial No. _____

Retain this information for future reference.

Kenmore
MICROWAVE OVEN
Use and Care

YOUR SAFETY FIRST

The Sears Kenmore Microwave Oven, though simple to use, is not a toy. Respect it as an electric cooking appliance. Become familiar with microwave energy, its uses and limitations.

PRECAUTIONS TO AVOID POSSIBLE EXPOSURE TO EXCESSIVE MICROWAVE ENERGY

- (a) DO NOT ATTEMPT to operate this oven with the door open since open-door operation can result in harmful exposure to microwave energy. It is important not to defeat or tamper with the safety interlocks.
- (b) DO NOT PLACE any object between the oven front face and the door or allow soil or cleaner residue to accumulate on sealing surfaces.
- (c) DO NOT OPERATE the oven if it is damaged. It is particularly important that the oven door closes properly and that there is no damage to the:
 - (1) DOOR (bent)
 - (2) HINGES AND LATCHES (broken or loosened)
 - (3) DOOR SEALS AND SEALING SURFACES
- (d) THE OVEN SHOULD NOT BE ADJUSTED OR REPAIRED BY ANYONE EXCEPT PROPERLY QUALIFIED SERVICE PERSONNEL.

IMPORTANT—FOR PROPER AND SAFE USE OF YOUR OVEN

- The oven must be level.
- The glass tray must be in the oven during cooking.
- The metal rack must be removed from the oven when the rack is not used for cooking.
- The oven should be thoroughly checked by a trained service technician, should it be dropped or damaged, before it is operated again.
- The electrical power cord must be kept dry and must not be pinched or crushed in any way.
- The oven has several built-in safety switches to make sure the power remains off when the door is open. DO NOT try to defeat these switches.

DON'TS

- DO NOT attempt to operate this oven with the door open.
- DO NOT run the oven empty without food in it.
- DO NOT operate the oven empty with the temperature probe plugged in.
- DO NOT run the oven empty with the Metal Rack in it.
- DO NOT use browning dishes on Metal Rack.
- DO NOT use foil or metal containers on the Metal Rack.
- DO NOT allow the temperature probe sensor to touch the sides, bottom or door of the oven when it is in use.
- DO NOT use the temperature probe in a regular oven.
- DO NOT store burnable material, such as food, in your microwave oven.
- DO NOT use this microwave oven for commercial purposes. This Sears Kenmore Microwave Oven is made for household use only.

SAFETY CERTIFICATION

The Sears Kenmore Microwave Oven is designed and thoroughly tested to meet exacting safety standards. It meets UL and FCC requirements and complies with safety performance standards of the U.S. Department of Health and Human Services.

TABLE OF CONTENTS

General Instructions

| | |
|----------------------------------------|---|
| ■ Location of Model Number Label | 4 |
| ■ Installation | 5 |
| ■ Setting “Time of Day” | 5 |
| ■ Names of Oven Parts | 6 |
| ■ Oven Control Panel | 7 |

Use Instructions

| | |
|----------------------------------------|----|
| ■ Use Instructions—Cooking Guide | 8 |
| ■ Easy Use Chart | 9 |
| ■ Recall and Change of Settings | 10 |
| ■ Pause between Stages | 10 |
| ■ Regular Timer | 10 |

Detailed Directions

| | |
|--------------------------------------------------------------------------------|------------|
| ■ “HI-Power” Cooking | 11 |
| ■ Cooking Guide for “Multi-Power” Settings | 12 |
| ■ “Multi-Power” Cooking | 13 |
| ■ “Temperature Controlled” Cooking | 14–16 |
| ■ Temperature Controlled “HI-Power” Cooking and Automatic “Hold Warm” | 17 |
| ■ Temperature Controlled “Multi-Power” Cooking and Automatic “Hold Warm” | 18 |
| ■ Two, Three or Four-Stage Cooking | 19–20 |
| ■ Delay-Start Cooking | 21 |
| ■ Whole Meal Cooking | 22 |
| ■ Programmed Defrost by Time | 23–27 |
| ■ Programmed Defrost by Temperature | 28 |
| ■ Preset Recipe Cooking | 29–31 |
| • Auto Recipe 300 | 29–30 |
| • Use of Quantity key | 31 |
| ■ Programming New Recipes | 31 |
| Utensils | 32 |
| Care and Cleaning | 33–35 |
| Questions and Answers | 36–37 |
| Before Calling for Service | 38 |
| Sears Service | 39 |
| Sears Warranty | Back Cover |

**SEARS KENMORE MICROWAVE OVEN
"USE AND CARE MANUAL"—
MICROWAVE OVEN USE INSTRUCTIONS**

Enjoy a new cooking experience from Sears. Please read this booklet. It takes only a few minutes—time well spent to learn how to use all of the features.

Advice on the use and care of Sears appliances is always available at your nearest Sears store. When seeking information, be sure you have the complete model number which is located on the plastic label. See below for its location.

MODEL NUMBER

To make a request for service, information or replacement of parts, Sears will require the complete model number of your microwave oven. The number is on the inner left side of the control panel. (You must open the door to see the number). The model number is also located on the back of the cabinet.

The number will look like this: 564.8000000.

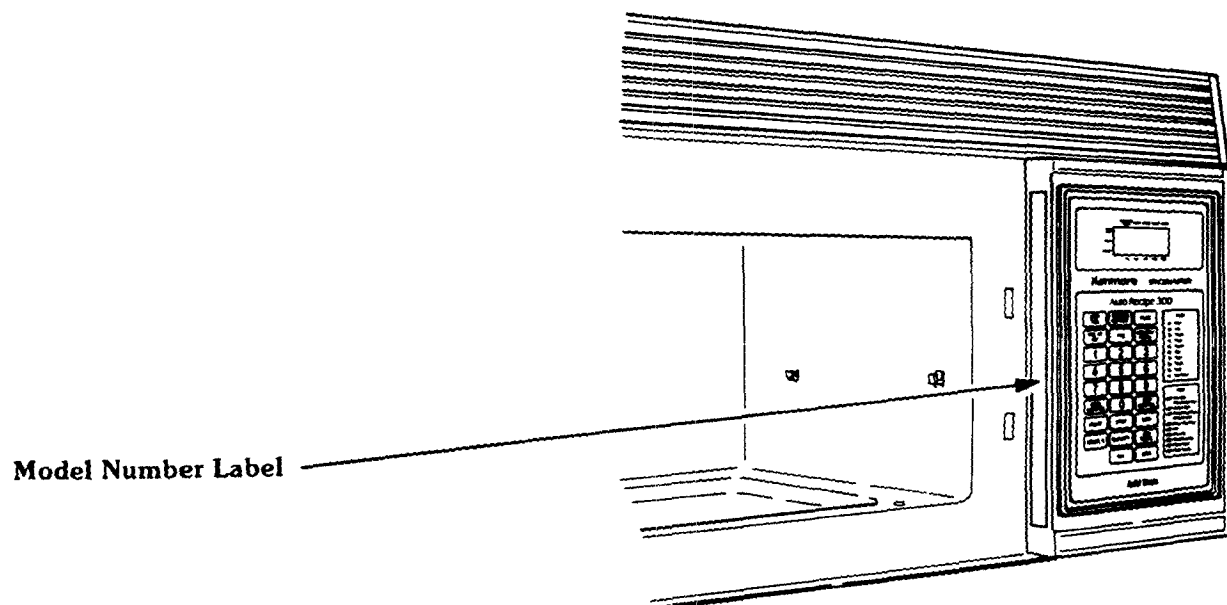

INSTALLATION

Complete Installation Instructions are included in the separate instruction manual. If you have any question on installation, please contact your Sears sales person or local Sears Service Center.

A mounting space of 33" or more from the surface of cooktop to the bottom of kitchen top cabinet, and at least 30" wide is required to mount the oven.

When the Oven is first turned on after installation, the Display Window will flash until you touch CLEAR.

Note: If your oven does not operate properly, unplug the oven from the 120-volt household outlet and then plug it back in.

SETTING TIME OF DAY

- Touch CLEAR
- Touch TIME OF DAY
- Touch numbers for correct time
- Touch TIME OF DAY

DIMENSIONS

| | |
|--------|----------|
| Height | 19-3/8" |
| Width | 29-7/8" |
| Depth | 19-1/4" |
| Weight | 106 lbs. |

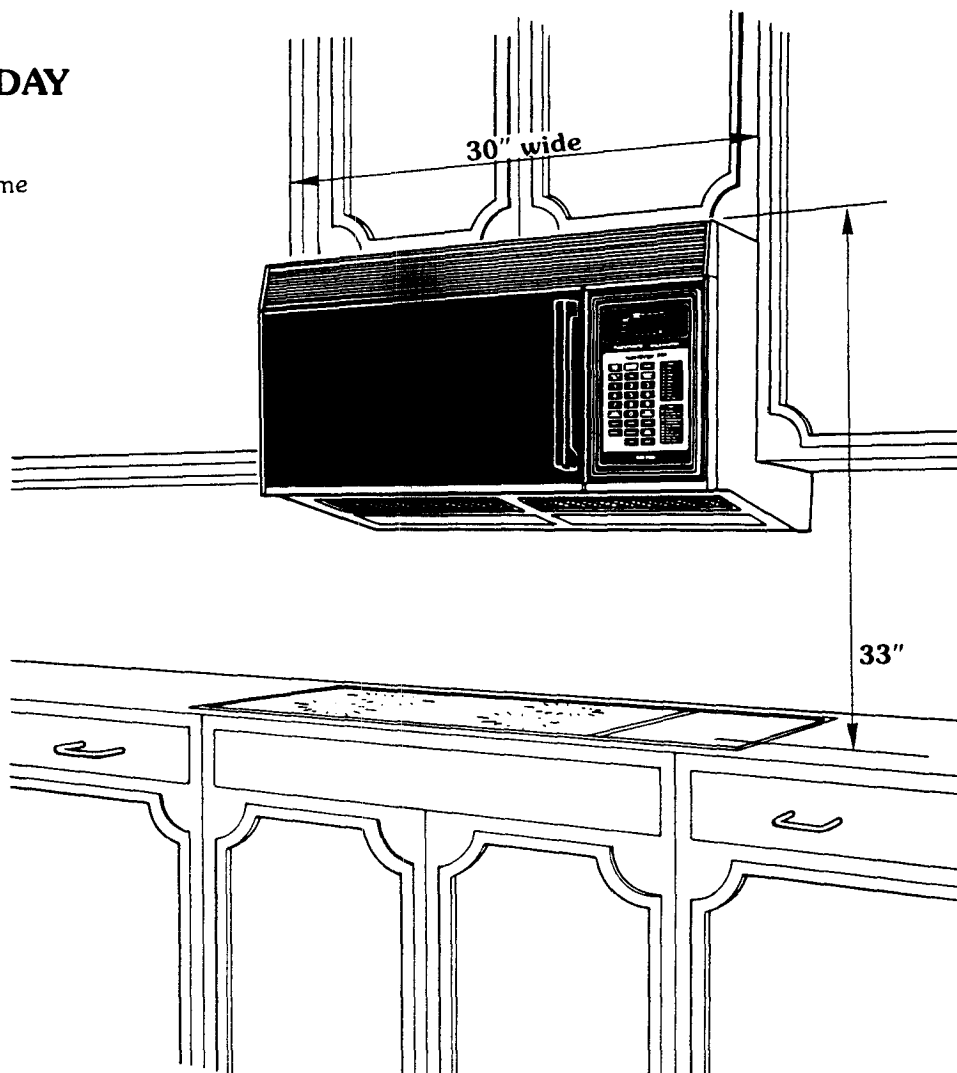

NAMES OF OVEN PARTS

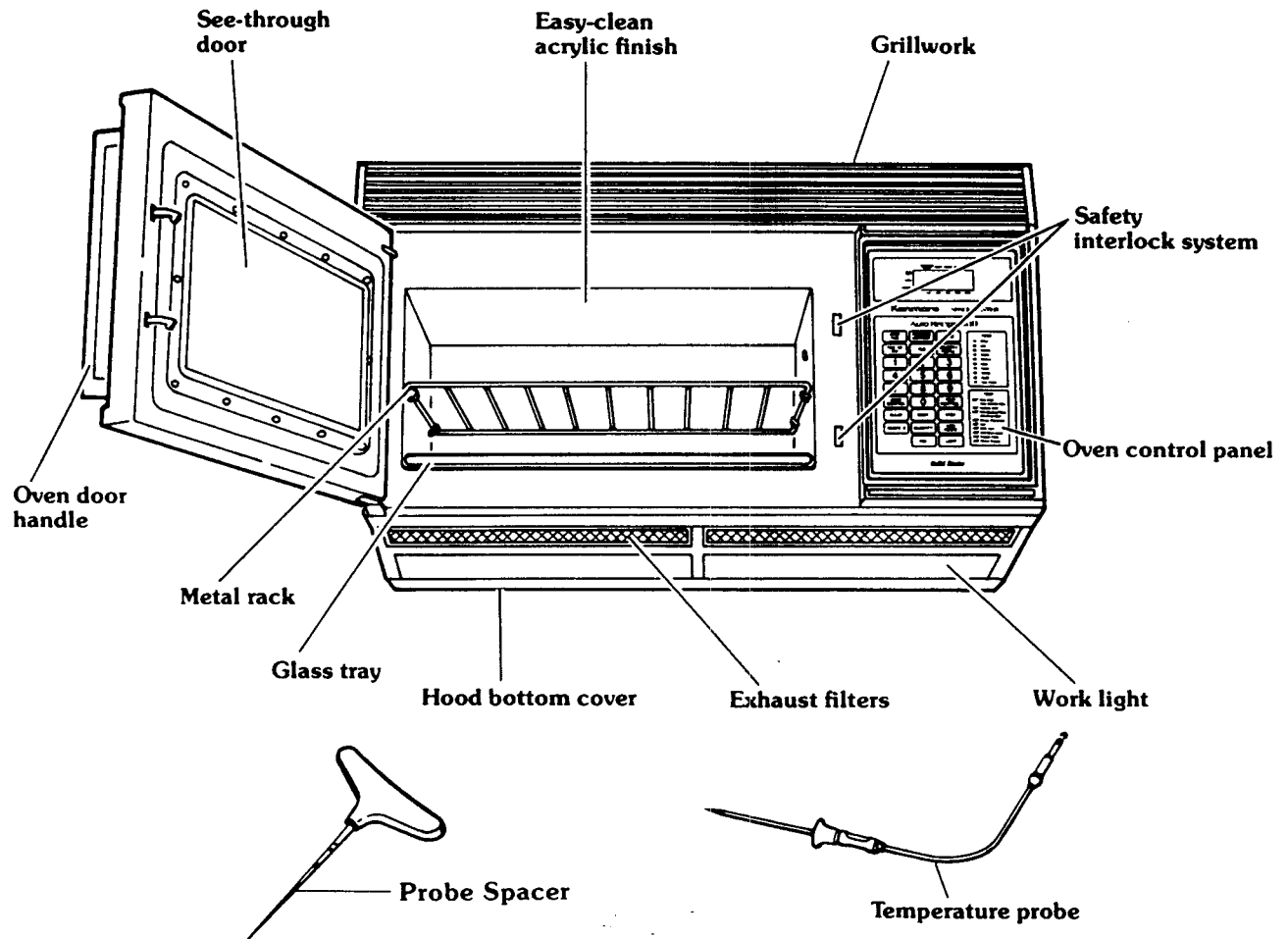

Please read "Requirements For Installation" section in Installation Manual before you remove the rest of contents from carton.

Your Oven will come with the following items.

| | |
|-------------------------------------------|--------|
| Glass Tray | 1 each |
| Metal Rack | 1 each |
| Temperature Probe | 1 each |
| Probe Spacer | 1 each |
| Cookbook | 1 each |
| Use and Care Manual | 1 each |
| Easy Use Chart Card | 1 each |
| Installation Instruction Manual | 1 each |
| Top Cabinet Template | 1 each |
| Wall Template | 1 each |
| Hardware Package | 1 each |
| Damper/Duct Connector | 1 each |

Do not use this Sears Kenmore Microwave Oven for commercial purposes. This microwave oven is made for household use only.

OVEN CONTROL PANEL

Stage Lights—When cooking stages are set, lights will go on indicating the stage in which your oven is cooking.

Indicator Lights—Time, Cook, Temp, Recipe, Delay-start and Programmed Defrost lights indicate which cooking operation is being used.

Quantity Light—When preset cooking is set light indicates that multiplication can be used in the recipe.

Programmed Defrost—Used in setting programmed defrost.

Stop Time—Used in setting a Delay-Start cooking. Cooking can be finished at the preset stop time.

Time of Day—Used in setting Time of Day.

Time—Used in setting Cooking Time.

Numbers—Used to enter the:

- Time of day.
- Delay-start time.
- Cooking times.
- Cooking powers.
- Cooking temperatures.

Cook Control—Used to select cooking power levels.

Clear—Clears all entries except TIME OF DAY. Once cooking has begun, however, CLEAR will function only after STOP has been touched.

Recipe*—Used in preset recipe cooking.

Start—Starts the oven.

Quantity—Used in multiplying base quantity of preset recipes.

Fan Control—Exhausts the air by hood fan.

Work Light—Lights up cooktop or countertop.

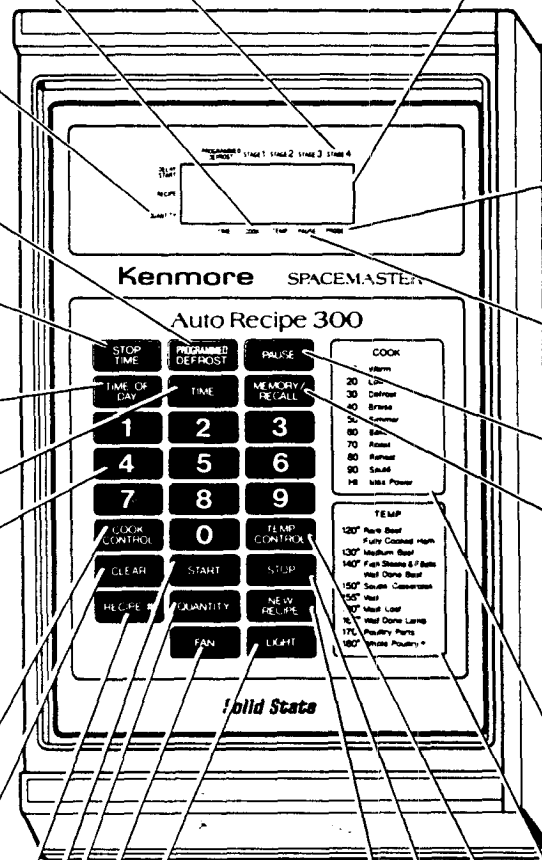

Display Window—Used to show:

- Time of day.
- Cooking time.
- Cooking power level.
- Cooking temperature.
- Hold.
- Pause (PAUS).
- Defrost (dEF).
- Recipe #.

It also functions as countdown timer or temperature indicator when cooking.

Probe Light—Flashes to warn that temperature probe is not plugged into the socket inside the oven for "Temperature Control" cooking.

Pause Light—Shows oven has been set to pause between the cooking stages.

Pause—Used to stop oven between cooking stages.

Memory/Recall—For two, three, four-stage cooking MEMORY/RECALL is used in setting:

- Cooking time.
- Power level.
- Temperature.

Also, it is used to recall each memory stage in a multiple-stage cooking program.

Cook Guide—Cooking guide which lists the types of cooking that most often occur at these cooking power levels.

Temp Guide—Temperature guide which lists the examples of food that are best cooked at these temperatures.

Temp Control—Used in setting the desired food temperature and the programmed defrost by temperature. "Temperature Control" cooking can be done only when the temperature probe is plugged into the socket inside the oven.

New Recipe—Used in programming new recipes.

Stop—Stops the oven.

NOTE: A "beep tone" sounds when a "pad" on the control panel is touched, to indicate a setting has been entered.

USE INSTRUCTIONS—COOKING GUIDE

“HI-POWER” COOKING

“HI” gives the highest power cooking possible with your microwave oven. It is the recommended setting for cooking foods with high moisture content or for cooking foods that need fast cooking to maintain their natural flavor and texture. Your *Kenmore Microwave Cooking* cookbook will tell you which foods are cooked best using the highest microwave cooking power (“HI”). For detailed directions on “HI” (maximum power) cooking, see Page 11.

“MULTI-POWER” COOKING

Many foods need slower cooking (at less than full power) in order to give the best results. In addition to “HI”, there are ninety-nine “multi-power” settings. Detailed directions for “multi-power” cooking are on Page 13.

TEMPERATURE CONTROLLED “HI-POWER” COOKING

“HI-Power” with TEMP CONTROL allows you to cook food to a preset temperature using maximum speed. Follow the directions on Page 17 and you will be able to preset the temperature you desire with the aid of the “Temperature Control” cooking guide.

TEMPERATURE CONTROLLED “MULTI-POWER” COOKING

“Multi-Power” with TEMP CONTROL allows you to cook more sensitive foods to a preset temperature by using slower microwave cooking speeds. See Page 18 for detailed directions.

AUTOMATIC “HOLD WARM”

After reaching the set temperature, the oven switches into “Hold Warm” to keep the food warm.

“Hold” will show in the display window and will continue to show for up to sixty minutes or until the door has been opened or STOP has been touched. See Pages 17 and 18.

FOUR-STAGE COOKING

Some recipes need more than one cooking stage. Many foods will cook better when cooked for a period of time at one power setting and then cooked for another period of time at a different power setting. With a cake, for example, the cookbook may recommend cooking at the “60 (Bake)” setting, followed by a period of cooking time at the “HI” setting. “Bake” allows the cake to rise gently, and then “HI” finishes the cooking cycle. You can preset up to four stages at the beginning, start the oven, and then the oven will change automatically into the second stage at the preset time. “Two, Three or Four-Stage Cooking” with both TIME and TEMP CONTROL can also be set. For detailed directions on “Two, Three or Four-Stage Cooking”, see Pages 19 and 20.

DELAY START COOKING

For those times when you must be away from the kitchen, but want dinner ready when you return, cooking can be started and finished at the time of day selected. See page 21 for detailed directions.

WHOLE MEAL COOKING

The Metal Rack increases the oven cooking space. To cook two or more different foods at one time, choose their proper places inside the oven by following the cookbook directions. See page 22.

PROGRAMMED DEFROST

Power level will automatically change for proper thawing of dense food items. See pages 23 thru 28 for detailed directions.

PRESET RECIPE COOKING — “Auto Recipe 300” and “3 Customer Programmable Recipes”

300 Recipes were developed by our cooking experts and have been preset into this oven for automatic cooking.

To use “AUTO RECIPE 300” cooking, touch RECIPE #, the numbers corresponding with the desired Recipe(s) shown in the cook-book and then START.

See pages 29 thru 31 of this Manual, as well as your Kenmore Microwave Cookbook for detailed directions.

In addition to AUTO RECIPE 300, 3 more recipes (Recipe #301—303) can be programmed by yourself for preset recipe cooking. See page 31 of this manual for detailed directions.

AUTOMATIC HOOD FAN CONTROL

The two-speed fan can be turned on by touching the FAN key. It is also automatically run at high speed by a heat sensing device. The sensing device detects overheating conditions from the heating surface below and turns on the fan to prevent damage to the oven. Once it is run by the sensing device, it can not be defeated by the FAN key. It continuously runs until the temperature of the Oven drops to a safe level.

EASY USE CHART

Your new solid state control system allows you to use your microwave oven in many ways.

| TIME OF DAY | "HI-POWER" COOKING | "MULTI-POWER" COOKING |
|----------------------------------------------------------------------------------------------------------------------------------------------------------------------------------------------------------------------------------------------------------------------------------------------------------------------------------------------------------------------------------------------------------------------------------------------------------------------------------------------------------------------------------------------------------------------|---------------------------------------------------------------------------------------------------------------------------------------------------------------------------------------------------------------------------------------------------------------------------------------------------------------------------------------------------------------------------------------------|--------------------------------------------------------------------------------------------------------------------------------------------------------------------------------------------------------------------------------------------------------------------------------------------------------------------------------------------------------------------------------------------------------------------------------------------------------------------------------------------------------------------------------------------------------------------------------------------------------------------------------------|
| <p>To set:</p> <ol style="list-style-type: none"> 1. Touch CLEAR. 2. Touch TIME OF DAY. 3. Touch numbers for correct time of day. 4. Touch TIME OF DAY.* <p>*This "locks" in the time and starts the clock running.</p> | <p>To set:</p> <ol style="list-style-type: none"> 1. Touch CLEAR. 2. Touch TIME. 3. Touch numbers for desired cooking time. 4. Touch START. <p>(See Page 11 for more detailed instructions.)</p> | <p>To set:</p> <ol style="list-style-type: none"> 1. Touch CLEAR. 2. Touch TIME. 3. Touch numbers for desired cooking time. 4. Touch COOK CONTROL. 5. Touch numbers for desired cooking power level. 6. Touch START. <p>(See Page 13 for more detailed instructions.)</p> |
| <p>TEMPERATURE CONTROLLED "HI-POWER" COOKING</p> | <p>TEMPERATURE CONTROLLED "MULTI-POWER" COOKING</p> | <p>FOUR-STAGE COOKING</p> |
| <p>To set:</p> <ol style="list-style-type: none"> 1. Plug in temperature probe. 2. Touch CLEAR. 3. Touch TEMP CONTROL. 4. Touch numbers for desired cooking temperature. 5. Touch START. <p>(See Page 17 for more detailed instructions.)</p> | <p>To set:</p> <ol style="list-style-type: none"> 1. Plug in temperature probe. 2. Touch CLEAR. 3. Touch TEMP CONTROL. 4. Touch numbers for desired cooking temperature. 5. Touch COOK CONTROL. 6. Touch numbers for desired cooking power level. 7. Touch START. <p>(See Page 18 for more detailed instructions.)</p> | <p>To set:</p> <ol style="list-style-type: none"> 1. Touch CLEAR. 2. Touch TIME or TEMP CONTROL. 3. Touch numbers for cooking time or temperature. 4. Touch COOK CONTROL. 5. Touch numbers for cooking power level. 6. Touch MEMORY/RECALL or PAUSE and repeat steps 2-5 to set 2nd cooking stage. 7. Touch MEMORY/RECALL or PAUSE and repeat steps 2-5 to set 3rd cooking stage. 8. Touch MEMORY/RECALL or PAUSE and repeat steps 2-5 to set 4th cooking stage. 9. Touch START. <p>(See Pages 19 and 20 for more detailed instructions.)</p> |
| <p>DELAY START COOKING</p> | <p>PROGRAMMED DEFROST BY TEMPERATURE</p> | <p>PROGRAMMING NEW RECIPES</p> |
| <p>To Set:</p> <ol style="list-style-type: none"> 1. Touch CLEAR. 2. Touch STOP TIME. 3. Touch Numbers for time of day to finish cooking. 4. Touch TIME. 5. Touch numbers for cooking time. 6. Touch COOK CONTROL. 7. Touch numbers for cooking power level. 8. Touch START. <p>* Three-Stage cooking can be used with Delay Start. After step 3 above, follow instructions for Four-Stage cooking beginning with step 2.</p> <p>(See Page 21 for more detailed instructions.)</p> | <p>To set:</p> <ol style="list-style-type: none"> 1. Drill food by using the Probe Spacer furnished with the oven. 2. Place Temperature Probe into hole and plug into socket. 3. Touch CLEAR. 4. Touch PROGRAMMED DEFROST. 5. Touch TEMP CONTROL. 6. Touch START. <p>(See Page 28 for more detailed instructions.)</p> | <p>To set:</p> <ol style="list-style-type: none"> 1. Touch CLEAR. 2. Touch NEW RECIPE. 3. Touch RECIPE #. 4. Touch numbers for New Recipe #. 5. Program Recipe following suitable operating instructions. 6. Touch NEW RECIPE. <p>(See Page 31 for more detailed instructions.)</p> |
| <p>PROGRAMMED DEFROST BY TIME</p> | <p>PRESET RECIPE COOKING (Auto Recipe 300 & 3 Customer Programmable Recipes)</p> | <p>HOOD FAN CONTROL</p> |
| <p>To set:</p> <ol style="list-style-type: none"> 1. Touch CLEAR. 2. Touch PROGRAMMED DEFROST. 3. Touch numbers for desired defrost time. 4. Touch START. <p>(See Pages 23 thru 27 for more detailed instructions.)</p> | <p>To set:</p> <ol style="list-style-type: none"> 1. Touch CLEAR. 2. Touch Recipe#. 3. Touch numbers for correct Preset Recipe#. 4. Touch START. <p>(See Pages 29 thru 31 for more detailed instructions.)</p> | <p>To set:</p> <ol style="list-style-type: none"> 1. Touch FAN once for low speed and twice for high speed. 2. Touch FAN again for turning the fan off. <p>* If over-heating of the Oven occurs, the fan will run by itself until the temperature of the Oven drops to a safe level.</p> |

RECALL AND CHANGE OF SETTINGS

To Recall a Setting

To recall (check) a setting **before you start the oven**, follow the directions below.

- To check the setting for a given stage, touch MEMORY/RECALL one or more times until the correct stage light and indicator light turns on. The set TIME or TEMP CONTROL for that stage will show in the display window.
- To check the cooking power level, touch COOK CONTROL.

To recall (check) a setting **while the oven is operating**, follow the directions below.

- To check settings while the oven is operating, touch the desired pad to recall the setting for the operating stage.
- To recall a future stage, touch STOP, follow the directions above for recalling (checking) a setting before starting the oven, and then touch START to continue cooking.
- To recall TIME OF DAY while the oven is running, touch TIME OF DAY. It will show momentarily in the display window.
- To recall Recipe number (s) while the oven is running, touch RECIPE #, and it will show momentarily in the display window.

To Change a Setting

Recall the setting to be changed by following the directions above and make the change as follows:

- Touch STOP The oven will stop cooking.
- Touch TIME Then touch "0" until only one "0" shows in the display window. Set the cooking time.
- Touch TEMPERATURE CONTROL Set cooking temperature.
- Touch COOK CONTROL Set cooking power level. To reset to "HI", set "99", maximum power.

PAUSE BETWEEN STAGES

Some recipes require stirring, turning and adding or removing of foods between stages. To set the oven to stop between stages, touch PAUSE rather than MEMORY/RECALL when setting the oven. After the pause, to restart the oven, touch START.

REGULAR TIMER

Your oven also has a timer that can be used for noncooking functions. When used as a regular timer, the oven is not running. The timer is simply counting down in seconds. For detailed instructions on using this timer, see below.

To use the regular timer feature:

1. Touch CLEAR.
2. Touch TIME.
3. Touch correct numbers for the time.
4. Touch COOK CONTROL.
5. Touch "0" (power level 0).
6. Touch START. The time will begin counting down in the display window with no cooking or heating in the oven. A tone will sound when the time is over.

"HI-POWER" COOKING

1. Touch CLEAR, and a beep tone will be heard. The CLEAR erases all previous settings.
2. Touch TIME. The lights above TIME and below STAGE 1 will go on. ("0" will show in the display window.)
3. Touch the correct numbers on the control panel to set the cooking time. The time set will show in the display window at the top of the control panel. For example:
 - To set 30 seconds, you would touch "3" and then "0".
 - To set 3 minutes, touch "3", "0" and "0".
 - To set 3½ minutes, touch "3", "3" and "0".

Remember, the timer is a digital clock that is divided into minutes and seconds. Therefore, ½ minute is equal to 30 seconds. Touch 30 and not 50 as with a calculator to indicate ½.

NOTE: It is not necessary to touch COOK CONTROL when cooking with the highest power ("HI"). However, if COOK CONTROL is touched, the light above COOK will go on and the word "HI" will show in the display window. This is to let you know that the oven will be operating on "HI" power unless a different power setting is chosen.

4. Touch START. The oven will begin cooking, and the display window will show the time counting down in seconds. A tone sounds for two seconds when the cooking time is completed. Then the oven shuts itself off.

NOTE: To stir food during cooking: open the oven door; stir or turn the food; close the oven door; and touch START. The oven will automatically continue to count down the amount of time left on the timer.

EXAMPLE: Fresh fish can be cooked quickly on "HI" (maximum power) for 6 minutes. To do this, follow these 4 simple steps:

1. Touch CLEAR.
2. Touch TIME.

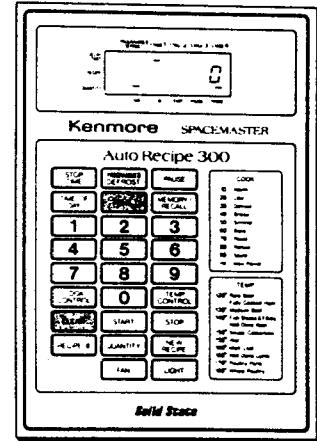

3. Set 6 minutes by touching "6", "0" and "0". "600" will show in the display window.

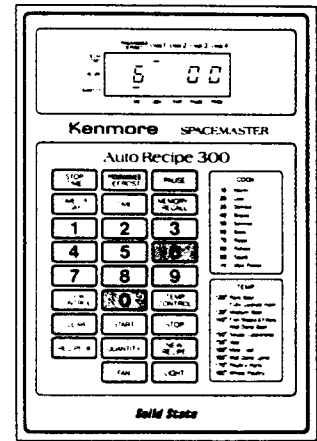

4. Touch START. The oven will begin to cook and the time will begin to count down in the display window. A tone will sound for 2 seconds when the 6 minutes are over and the oven will shut itself off.

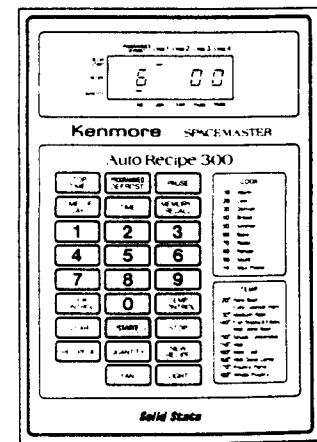

COOKING GUIDE FOR “MULTI-POWER” SETTINGS

The “Multi-Power” feature lets you cook at the best power level for the food being cooked. Cooking directions can be found in the cookbook.

| POWER LEVEL | POWER SETTINGS | EXAMPLES |
|-------------|----------------|---------------------------------------------------------------------------------------------------------------------------------------------------------------------------------------------------------------------------------------------------------------------------|
| 10 | WARM | <ul style="list-style-type: none"> • Softening cream cheese. • Keeping casseroles and main dishes warm. |
| 20 | LOW | <ul style="list-style-type: none"> • Softening chocolate. • Heating breads, rolls, pancakes, tacos, tortillas and French toast. • Clarifying butter. • Taking the chill out of fruit. • Heating small amounts of food. |
| 30 | DEFROST | <ul style="list-style-type: none"> • Thawing meat, poultry and seafood. • Completing the cooking cycle of casseroles, stews and some sauces. • Cooking small quantities of most food. |
| 40 | BRAISE | <ul style="list-style-type: none"> • Cooking less tender cuts of meat in liquid or slow cooking dishes. • Completing the cooking cycle of less tender roasts. |
| 50 | SIMMER | <ul style="list-style-type: none"> • Cooking stews and soups after bringing to a boil. • Cooking baked custards and pasta. |
| 60 | BAKE | <ul style="list-style-type: none"> • Cooking scrambled eggs. • Cooking cakes. |
| 70 | ROAST | <ul style="list-style-type: none"> • Cooking rump roast, ham, veal, and lamb. • Cooking cheese dishes. • Cooking eggs and milk. • Cooking quick breads and cereal products. |
| 80 | REHEAT | <ul style="list-style-type: none"> • Reheating precooked or prepared food quickly. • Heating sandwiches. |
| 90 | SAUTÉ | <ul style="list-style-type: none"> • Cooking onions, celery and green peppers quickly. • Reheating meat slices quickly. |
| 100 (HI) | MAX POWER | <ul style="list-style-type: none"> • Cooking tender cuts of meat. • Cooking poultry, fish, vegetables and most casseroles. • Preheating the browning dish. • Boiling water. • Thickening some sauces. |

As you get to know your microwave oven, you may find that a particular setting is too low or too high for the results you desire.

Multiple-power control gives you the means to obtain greater precision in setting power levels. For instance, if you want a power level between ROAST and REHEAT, you would set the time as usual: touch COOK CONTROL, and then touch “7” and “5”. The display window will show “75”, indicating that your oven is set to run at Power Level 75 — halfway between ROAST and REHEAT.

“MULTI-POWER” COOKING

Many foods need slower cooking (at less than full power) in order to give you the best results. In addition to “HI” there are ninety-nine multi-power settings. The cookbook tells you which power setting is recommended for the food being cooked.

To Cook with “Multi-Power”

1. Touch CLEAR.
2. Touch TIME. The lights above TIME and below STAGE 1 will go on. (“0” will show in the display window.)
3. Touch numbers for the desired cooking time. The time set will show in the display window.
4. Touch COOK CONTROL. The light above COOK will go on. Also, the word “HI” will show in the display window until a lower setting is entered. This is to tell you that the oven will be operating on “HI” power unless a different power setting is chosen.
5. Touch numbers for desired cooking power level. For example, if the recipe calls for cooking at the “20 (LOW)” setting, you would touch “2” and “0”. The display window will show “20”. This means that the oven is in a LOW setting, the oven is cooking at power level 20.
6. Touch START. The oven begins to cook and the display window will show the time counting down. A tone will sound for 2 seconds when the cooking time is over. Then the oven shuts itself off.

Example: To warm 6 doughnuts, you would cook at power level “80 (REHEAT)” for 1-1/2 minutes. To do this, follow these six steps:

1. Touch CLEAR.
2. Touch TIME.
3. Set 1-1/2 minutes by touching “1”, “3”, and then “0”. “130” will show in the display window.

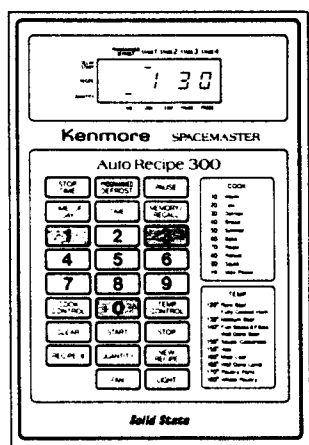
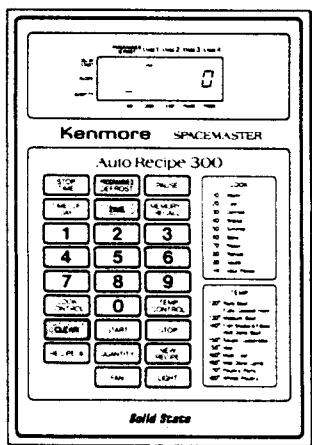

4. Touch COOK CONTROL. The display window will show “HI”.

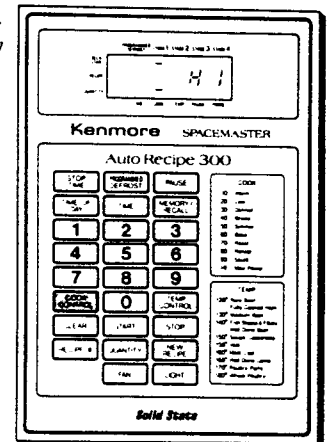

5. Choose the “80 (REHEAT)” setting by touching the numbers “8” and “0”. The display window will show “80”. This means the oven is cooking at power level 80.

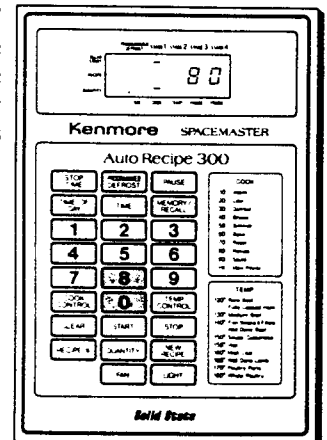

6. Touch START. The oven begins to cook and the time will begin to count down in the display window. A tone will sound for 2 seconds when the 1-1/2 minutes are over and the oven will shut itself off.

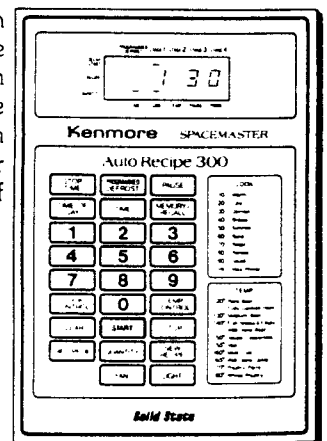

“TEMPERATURE CONTROLLED” COOKING

The temperature probe is used to judge doneness when cooking or reheating food. Set the desired food temperature with the TEMP CONTROL and the desired power level with the COOK CONTROL. When the food reaches the desired temperature, the oven will hold the food at the desired temperature up to one hour.

TEMPERATURE SETTING & DISPLAY TEMPERATURE

Temperatures from 90°F to 200°F can be chosen and set in the oven. The temperature should be set in one-degree increment.

The display window will show the rise in food temperature in one-degree increment.

The display window will not accurately show food temperature below 90°F.

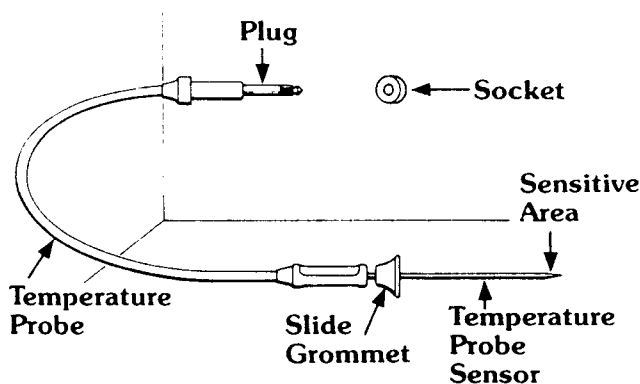

DEFINITIONS

TEMPERATURE PROBE SENSOR: The pointed metal portion of the probe which is placed into the food.

SENSITIVE AREA OF SENSOR: The first inch, or tip, of the temperature probe sensor.

PLUG: The end of the temperature probe that is plugged into the oven socket.

SOCKET: The outlet on the side of the oven wall.

CAUTION: Do not plug the pointed end of the temperature probe into the socket.

SLIDE GROMMET: Adjust the length of the temperature probe by sliding the grommet before inserting it into food so that the sensitive area of the probe can always be placed in the center of the food.

DISPLAY WINDOW: Shows the cooking temperature rising as the food is cooking. Chosen temperature may be seen during cooking by touching TEMP CONTROL. When chosen temperature is reached the display will show “Hold” for 60 minutes or until the door is opened or STOP is touched.

MEATS

- Choose only fresh, completely thawed meat.
- Place meat fat side down on the microwave roasting rack in a glass baking dish.
- Microwave cook on the first “multi-power” setting for half of the total cooking time. (See “Temperature Control” Meat Cooking Guide on Page 15.)
- Turn meat to fat side up and:

1. Place the temperature probe sensor into the meat with the first inch of the sensor in the center of the meat. The sensor should not touch the bone or fat pocket. The sensor should be put in from the side or from the front—it should not be put in from the top of the meat.
2. Plug the temperature probe into the socket on the side of the oven wall.
3. Choose the doneness temperature from the chart on Page 16. Set the temperature with the TEMP CONTROL.
4. Microwave cook the meat on the second “multi-power” setting. The microwave oven will turn itself off when the preset temperature is reached. Take the food out of the oven as soon as the display window shows “Hold”.
5. Remove the temperature sensor. Let the meat stand, covered with foil for about 10 minutes before serving. The temperature will rise about 15°F during standing time.

Note: It is normal for meats to become slightly overcooked in a small circular area in the immediate vicinity of the hole made by the meat probe.

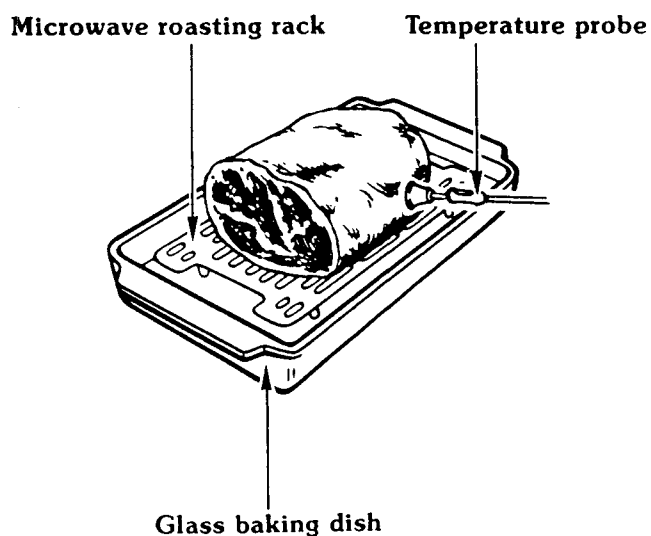

“TEMPERATURE CONTROL” POINTS TO REMEMBER

DO

- Place the temperature probe sensor into the thickest part of the meat or in the center of the food to be reheated. Avoid touching bone or fat.
- Check that the first inch of the sensor is in the densest part of the food to be cooked.
- Remove the temperature probe from the oven after use.
- Refer to cookbook for other information.

DO NOT

- Do not operate the oven while empty with the temperature probe plugged in.
- Do not let the temperature probe sensor touch the sides, bottom or door of the oven while in use.
- Do not use the temperature probe in a regular oven.
- Do not forget to turn meat between first and second settings.

“TEMPERATURE CONTROL” MEAT COOKING GUIDE

Refer to “Meats” section on Page 14.

| MEAT | FIRST SETTING AND TIME | SECOND SETTING AND TIME | TEMPERATURE PROBE AND COOK CONTROL SETTING | STANDING TIME |
|-----------------------------------------------------------|---------------------------------------------------------------------------------------------------------|----------------------------------------------------------------------------------------------------|--------------------------------------------|-------------------------------|
| BEEF Meat Loaf 2 lbs. | HI (Max. Power) 12 – 14 min. | | HI (Max. Power) 160°F | 5 – 10 min. |
| Rib Roast, boneless | HI (Max. Power) Rare 4 – 5 min. per lb. Medium 5 – 6 min. per lb. Well done 6 – 7 min. per lb. | 70 (Roast) Rare 3 – 4 min. per lb. Medium 5 – 6 min. per lb. Well done 6 – 7 min. per lb. | 70 (Roast) 120°F 130°F 140°F | 10 min. 10 min. 10 min. |
| Rib Roast, with bone | HI (Max. Power) Rare 3 – 4 min. per lb. Medium 4 – 5 min. per lb. Well done 5 – 6 min. per lb. | 70 (Roast) Rare 3 – 4 min. per lb. Medium 3 – 5 min. per lb. Well done 5 – 6 min. per lb. | 70 (Roast) 120°F 130°F 140°F | 10 min. 10 min. 10 min. |
| LAMB Lamb Leg or Shoulder Roast, with bone | 70 (Roast) Medium 4 – 5 min. per lb. Well done 5 – 6 min. per lb. | 70 (Roast) Medium 4 – 5 min. per lb. Well done 5 – 6 min. per lb. | 70 (Roast) 145°F 165°F | 5 min. 10 min. |
| Lamb Roast, Boneless | 70 (Roast) 5 – 6 min. per lb. | 70 (Roast) 5 – 6 min. per lb. | 70 (Roast) 150°F | 10 min. |
| VEAL Shoulder or Rump Roast, boneless 2 – 5 lbs. | 70 (Roast) 9 min. per lb. | 70 (Roast) 9 – 10 min. per lb. | 70 (Roast) 155°F | 10 min. |
| PORK Pork Loin Roast, boneless 3 – 5 lbs. | HI (Max. Power) 6 min. per lb. | 70 (Roast) 5 – 6 min. per lb. | 70 (Roast) 160°F | 10 min. |
| Pork Loin, center cut 4 – 5 lbs. | HI (Max. Power) 5 – 6 min. per lb. | 70 (Roast) 4 – 5 min. per lb. | 70 (Roast) 160°F | 10 min. |
| Ham, boneless, precooked | 70 (Roast) 5 – 7 min. per lb. | 70 (Roast) 5 – 7 min. per lb. | 70 (Roast) 120°F | 10 min. |
| Center Cut Ham Slice 1 – 1½ lbs. | 70 (Roast) 5 min. per lb. | 70 (Roast) 5 – 6 min. per lb. | 70 (Roast) 120°F | 10 min. |
| Smoked Ham Shank | 70 (Roast) 4 – 5 min. per lb. | 70 (Roast) 4 – 5 min. per lb. | 70 (Roast) 120°F | 10 min. |
| Canned Ham 3 lbs. | 70 (Roast) 5 – 6 min. per lb. | 70 (Roast) 5 – 6 min. per lb. | 70 (Roast) 120°F | 10 min. |
| 5 lbs. | 70 (Roast) 4 – 5 min. per lb. | 70 (Roast) 4 – 5 min. per lb. | 70 (Roast) 120°F | 10 min. |

REHEATING FOODS

- Place the temperature probe sensor into the food to be reheated with the first inch of the sensor in the center of the food.
- Plug the temperature probe into the socket on the side of the oven wall.
- Cover the food if desired.
- Set the temperature of the desired doneness. (See chart below.)
- Select “multi-power” setting as shown below.
- The microwave oven will stop cooking when the set temperature is reached and then it will “Hold Warm”.
- Remove the temperature probe from the oven after use.

“TEMPERATURE CONTROL” REHEATING GUIDE

| FOOD | SETTING | DONENESS | INSTRUCTIONS |
|-------------------------|----------------|----------|---------------------------------------------------------------------------------------------------------------------------------------------------------------------|
| Beverages | HI (MAX POWER) | 150°F | Place the temperature probe sensor in the center of the beverage glass. |
| Soups | 80 (REHEAT) | 150°F | Place the temperature probe sensor into the center of the soup. Cover with casserole lid, waxed paper, or plastic wrap. |
| Precooked Casseroles | 80 (REHEAT) | 150°F | Place temperature probe sensor into the center of the food. Cover with a casserole lid, waxed paper, or plastic wrap. |
| Canned Vegetables | 80 (REHEAT) | 150°F | Place the temperature probe sensor into the center of the food to be reheated. The sensitive area of the sensor should rest in the middle of the food. |
| Leftovers | 80 (REHEAT) | 150°F | Place the temperature probe sensor in the densest or largest amount of food. |
| Meat Sandwiches (Thick) | 80 (REHEAT) | 120°F | Place the temperature probe sensor into the thickest part of the sandwich to be warmed. The sensitive area of the sensor should be located in the sandwich filling. |
| Baked Foods | 80 (REHEAT) | 120°F | Place the temperature probe sensor into the center of the food to be reheated. The sensitive area of the sensor should rest in the middle of the food. |
| Syrup | 70 (ROAST) | 150°F | Place the temperature probe sensor into the center of the container. |

Caution: From time to time, the same kind of foods may vary in shape, form and density, and, therefore will not produce the same results each time. For this reason, we do not recommend using the temperature control settings for thin food items or for foods that require tenderiz-

ing by simmering. Also, in some cases the microwave oven may shut off prematurely. This means that either the temperature probe is not placed properly or that it should not be used with this type of food.

TEMPERATURE CONTROLLED "HI-POWER" COOKING AND AUTOMATIC "HOLD WARM"

The "Temperature Control Meat Cooking Guide" and "Reheating Guide" on Pages 15 and 16 will show you which multi-power setting and doneness temperature are recommended for the food you are cooking. When cooking with the temperature control settings, the timer is not used.

- Place the temperature probe into the food with the first inch of the sensor in the center of the food. Adjust the length of the temperature probe by sliding the grommet before inserting it into food so that the sensitive area of the probe can always be placed in the center of the meat. The probe should be in a level direction or on an angle as shown. *It should not be put in from the top.*

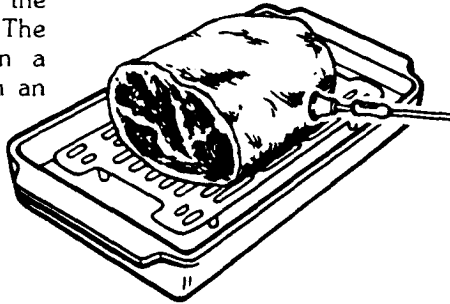

- Plug the temperature probe into the socket on the side of the oven.

Caution: Do not plug the pointed end of the temperature probe into the socket.

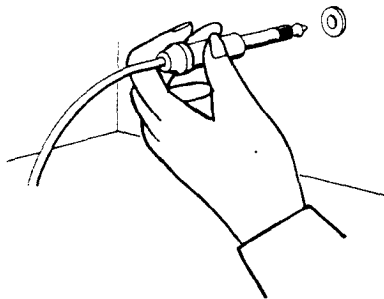

- Touch CLEAR.

- Touch TEMP CONTROL. The lights above TEMP and below STAGE 1 will go on, and "F" will show in the display window.

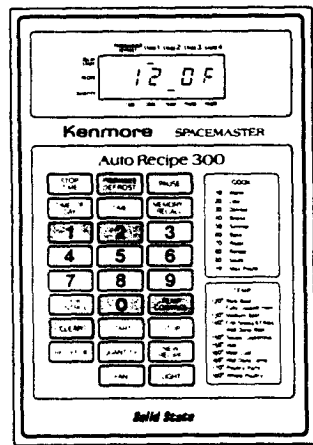

- Choose the food temperature and touch the corresponding numbers. For example, if the recipe calls for doneness at 120°F, you would touch the numbers "1", "2" and "0". When you touch "120" the display window will show "120F". If the temperature probe is not plugged into the socket, the probe light will flash and the oven will not work.

NOTE: It is not necessary to touch COOK CONTROL when you are cooking with "HI (MAX POWER)". However, if you touch COOK CONTROL the light above COOK will go on and the word "HI" will show in the display window. This is to remind you that the oven will work at "HI (MAX POWER)" unless a different power setting is chosen.

- Touch START. The oven will begin to cook and you will be able to see the temperature of the food rising in the display window. A tone will sound for one second when the desired temperature is reached.

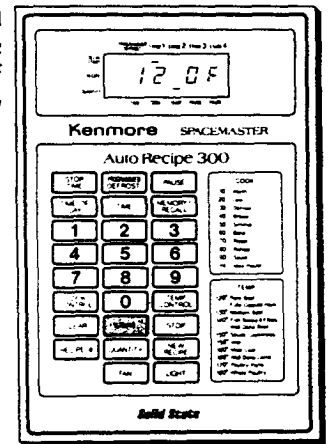

- The oven will switch into "Hold Warm" to keep the food warm. "Hold" will show in the display window. The cook control setting changes to "10 (WARM)". To check the temperature being held, touch TEMP CONTROL. The "holding" temperature will show in the display window. The "Hold Warm" will continue for 60 minutes after the food reaches the chosen temperature or until the door has been opened or until STOP has been touched. If the door is opened, the "Hold Warm" will stop. To reset, simply touch TEMP CONTROL, the corresponding numbers and START.

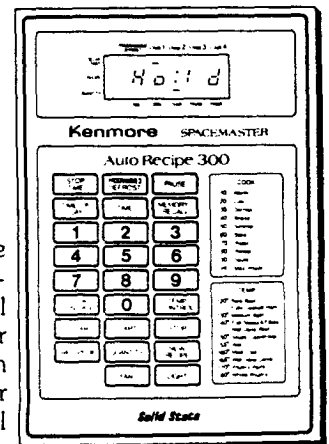

NOTE: The highest temperature to which the food may be set is 200°F. The temperature is displayed in 1°F increment.

TEMPERATURE CONTROLLED "MULTI-POWER" COOKING AND AUTOMATIC "HOLD WARM"

The "Temperature Control Meat Cooking Guide" and "Reheating Guide" on Pages 15 and 16 will show you which multi-power setting and temperature setting are recommended for the food you are cooking.

1. Place the temperature probe into the food with the first inch of the sensor in the center of the food. See step 1 on page 17.
2. Plug the temperature probe into the socket on the side of the oven. See step 2 on page 17.

CAUTION: Do not plug the pointed end of the temperature probe into the socket.

3. Touch CLEAR.
4. Touch TEMP CONTROL. The lights above TEMP and below STAGE 1 will go on, and "F" will show in the display window.

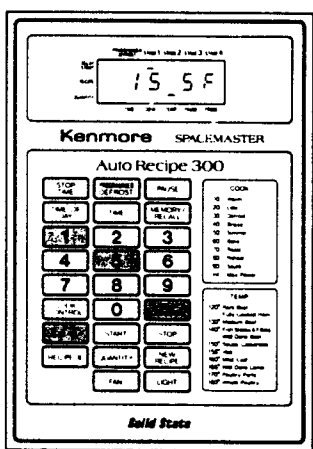

5. Choose the food temperature and touch the corresponding numbers. For example, if the recipe calls for doneness at 155°F, you would touch numbers "1" "5" and "5". When you touch "155", the display window will show "155F". If the temperature probe is not plugged into the socket, the probe light will flash and the oven will not work.

6. Touch COOK CONTROL. The light above COOK will go on. Also, the word "HI" will show in the display window until you enter a lower power setting. This is to remind you that the oven will always operate at full power unless you set a lower power.

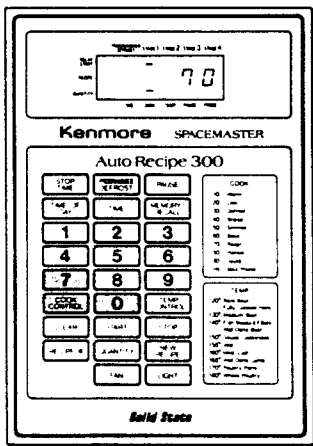

7. Choose the cook control setting you desire and touch the corresponding numbers. For example, if the recipe should call for cooking at the "70 (ROAST)" setting, you would touch numbers "7" and "0". When you touch "7" and "0", the display window will show "70". This means that in the "70 (ROAST)" setting, the oven is at power level 70.

8. Touch START. The oven will begin to cook and you will be able to see the temperature of the food rising in the display window.

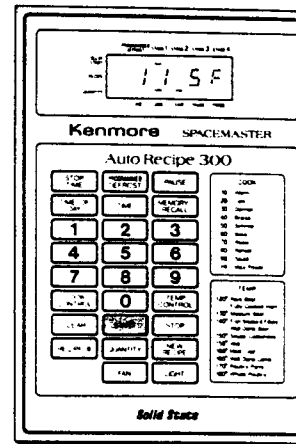

9. A tone will sound for one second when the temperature is reached. The oven will switch into "Hold Warm" to keep the food warm. The cook control setting automatically changes to "10 (WARM)". The display window will show "Hold".

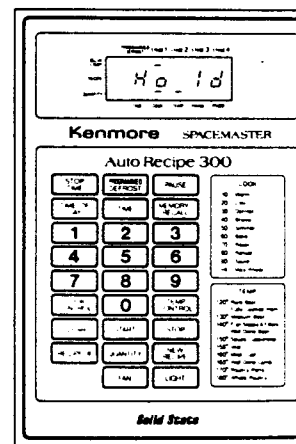

10. To be sure the correct temperature is being held, you may touch TEMP CONTROL. The "holding" temperature will show in the display window. The "Hold Warm" will continue for 60 minutes after the food reaches the chosen temperature or until the door has been opened or until STOP has been touched. If the door has been opened, the "Hold Warm" will stop. To reset, simply touch TEMP CONTROL, the corresponding numbers and START.

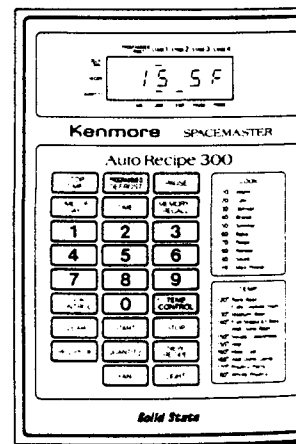

NOTE: The highest temperature that can be set is 200°F. The temperature is displayed in 1°F increment.

TWO, THREE OR FOUR-STAGE COOKING

Four-stage cooking lets you cook in four cooking stages each at a different power setting for a chosen time or temperature. Set all stages before cooking and start the oven. Simply follow these steps:

1. Touch CLEAR.
2. Touch TIME or TEMP CONTROL. The lights above TIME or TEMP and below STAGE 1 will go on. The display window will show "0" or "F".
3. Touch the correct numbers for the time or temperature of the first cooking stage.
4. Touch COOK CONTROL. The light above COOK will go on. The display window will show "HI".
5. Touch the correct numbers for the cooking power level of the first cooking stage (if other than "HI").
6. Touch MEMORY/RECALL or PAUSE. The light below STAGE 2 will go on. The display window will show "0".
7. Touch TIME or TEMP CONTROL.
8. Touch the correct numbers for the time or temperature of the second cooking stage.
9. Touch COOK CONTROL. The display window will show "HI".
10. Touch the correct numbers for the cooking power level in the second cooking stage (if other than "HI").
- 11A. Touch START for two-stage cooking.
- 11B. If three-stage or four-stage cooking is desired, touch MEMORY/RECALL or PAUSE. The light below STAGE 3 will go on. The display window will show "0".
Repeat steps 7-10 above to set the third cooking stage at the same or a different power level for a chosen time or temperature.
- 12A. Touch START for three-stage cooking.
- 12B. If four-stage cooking is desired, touch MEMORY/RECALL or PAUSE. The light below STAGE 4 will go on. The display window will show "0".
Repeat steps 7-10 above to set the fourth cooking stage at the same or a different power level for a chosen time or temperature.
13. Touch START.

EXAMPLE: (Four-stage cooking)
All-American Meat Balls
(10 minutes, power level 70) (PAUSE)
(3 minutes, power level 70) (PAUSE)
(2 minutes, power level 70)
(MEMORY/RECALL)
(5 minutes, power level 0)

The following steps explain how to set the oven.

First Stage (10 minutes; power level 70)

1. Touch CLEAR.
2. Touch TIME.
3. Set 10 minutes by touching "1", "0", "0" and "0". "1000" will show in the display window.

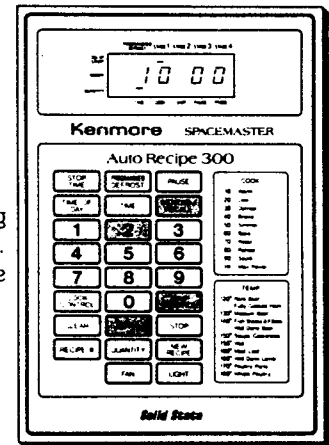

4. Touch COOK CONTROL. "HI" will show in the display window to remind you that the oven will operate at highest power unless you enter a lower power setting.
5. Touch numbers "7" and "0". "70" will show in the display window (indicating that you have set the oven to operate at power level 70). The first stage has been set.

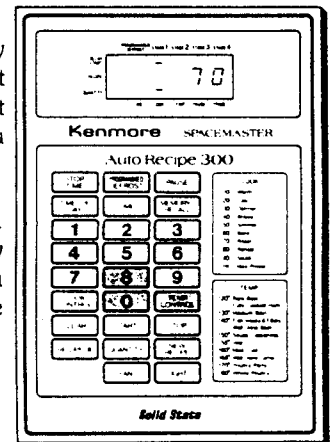

TWO, THREE OR FOUR-STAGE COOKING (Cont'd)

Second Stage (3 minutes; power level 70)

6. Touch PAUSE. The light below STAGE 2 will go on. The display window will show "0".
7. Touch TIME.
8. Set 3 minutes by touching "3", "0" and "0". "300" will show in the display window.
9. Touch COOK CONTROL and numbers "7" and "0". "70" will show in the display window. The second stage has been set.

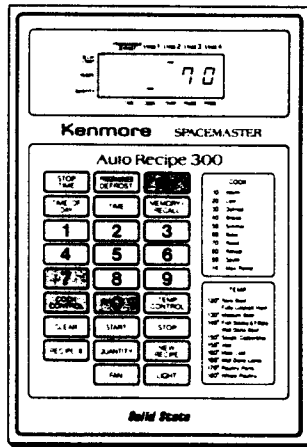

17. Touch COOK CONTROL and number "0". "0" will show in the display window. The fourth stage has been set.

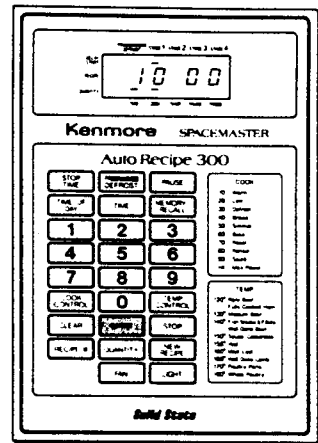

18. Touch START. The first stage will begin cooking. "1000" will show in the display window. The oven will begin to cook at a power level 70 and the time will begin to count down in the display window. When the 10 minutes are over, a tone will sound and the oven will stop. "PAUSE" will show in the display window.

Third Stage (2 minutes; power level 70)

10. Touch PAUSE. The light below STAGE 3 will go on. The display window will show "0".
11. Touch TIME.
12. Set 2 minutes by touching "2", "0" and "0". "200" will show in the display window.
13. Touch COOK CONTROL and numbers "7" and "0". "70" will show in the display window. The third stage has been set.

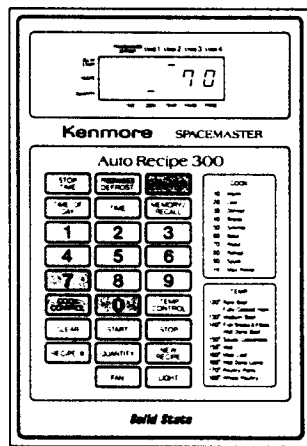

After the pause, to restart the oven, touch START for second cooking stage. "300" will show in the display window. The oven will begin to cook at "70" power level. When the 3 minutes are over, a tone will sound and the oven will stop. "PAUSE" will show in the display window.

After the pause, to restart the oven, touch START for third cooking stage. "200" will show in the display window. The oven will begin to cook at "70" power level. When 2 minutes are over, a tone will sound and the oven will change itself into the fourth stage. "500" will show the display window. When 5 minutes as "Standing time" are over, a tone will sound. The oven would have finished four stages.

Fourth Stage (5 minutes; power level 0)

14. Touch MEMORY/RECALL. The light below STAGE 4 will go on. The display window will show "0".
15. Touch TIME.
16. Set 5 minutes by touching "5", "0" and "0". "500" will show in the display window. The fourth stage has been set.

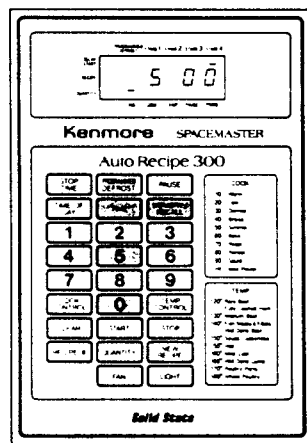

NOTES: When temperature control cooking is set in the fourth stage, the oven will switch into "Hold Warm" after cooking. The "Hold Warm" will continue for 60 minutes after the food reaches the chosen temperature or until the door has been opened or until STOP has been touched.

*"Standing time" allows the food to finish cooking and the heat to be uniform throughout. See the cookbook for detailed explanation.

If you touch MEMORY/RECALL instead of PAUSE, the oven will not stop but will remember the next stage and continue working.

DELAY START COOKING

Delay Start cooking can be done by starting the cooking automatically and finishing at a presetting delay time for the chosen cooking time.

1. Touch CLEAR.

2. Touch STOP TIME.

The light at right of DELAY START goes on. A display window will read "0:00".

3. Touch numbers for the time of day to finish cooking. For example, touch numbers "7", "3" then "0" for the cooking to be finished at "7:30", and "7:30" will show in the display window.

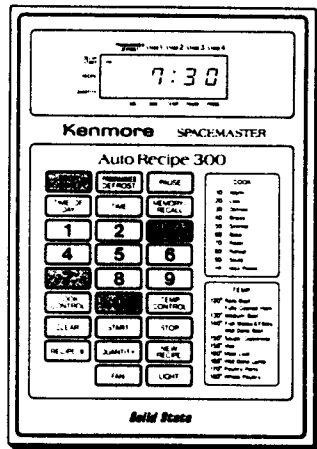

6. Touch COOK CONTROL.

7. Touch numbers for cooking power level.

For example, touch numbers "5" then "0", "50" will show in the display window.

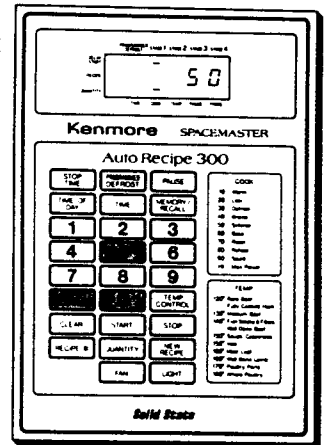

4. Touch TIME.

5. Touch numbers for cooking time.

For example, set 12 minutes by touching "1" then "2" then "0" twice. "1200" will show in the display window.

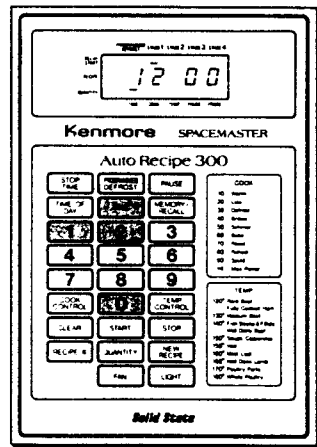

8. Touch START.

The time of day will show in the display window and the light at right of DELAY START goes on. As soon as the clock shows the Cook-Start Time which has been subtracted from the Cook-Finish Time, the oven will start cooking and the cooking time counts down in the display window. When the Cook-Finish Time (or "7:30") comes, the oven will shut itself off.

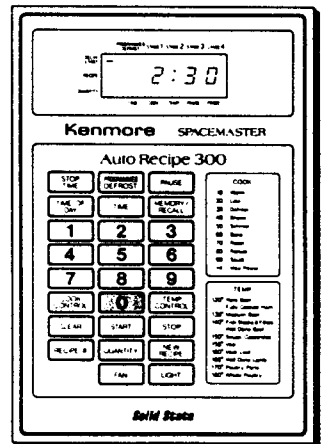

The display shows the time of day. For example: a half past two.

Note: A preset delay time must be less than 12 hours.

* Four-Stage cooking can be used with Delay Start. After step 3 above, follow instructions for Four-Stage cooking beginning with step 2.

* The Delay Start cooking is controlled by time. When "Temperature Control" cooking is set in a stage, cooking may be finished at the setting time with a slight time difference.

* Fresh food should not stand at room temperature over four hours prior to cooking.

WHOLE MEAL COOKING

(See Cookbook for detailed explanation)

Whole Metal cooking lets you cook two or more different foods at the same time. Foods need not be placed in the oven at the same time, nor be removed at the same time, unless needed. By using PAUSE rather than MEMORY/RECALL, the oven will stop between stages for time to add or remove food.

1. Place the Metal Rack in guides on the side wall of oven cavity as shown.
2. Place food into the oven.
3. Set the oven following the instructions given in the cook book.

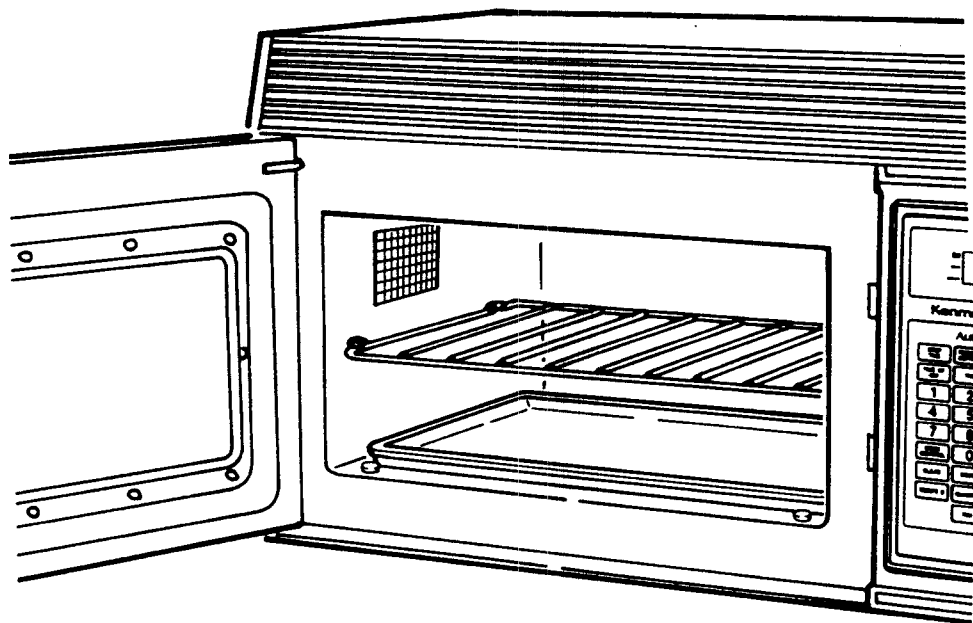

METAL RACK

- Remove Metal Rack from oven when not being used for cooking.
- Do not run the oven empty with the Metal Rack in it.
- The Metal Rack may get hot during cooking. Pot holders may be needed to remove Rack after cooking.
- Do not use browning dishes on Metal Rack.
- Do not use foil or metal containers on the Metal Rack.

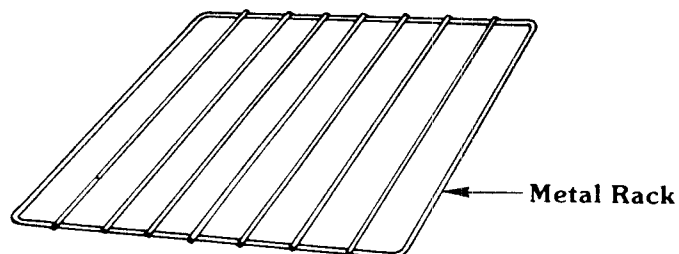

PROGRAMMED DEFROST BY TIME

The power levels for defrosting are predetermined and programmed into this oven. The oven will defrost at "HI" power for the beginning of the chosen time and at power level 30 for the remaining period of time.

1. Touch CLEAR.
2. Touch PROGRAMMED DEFROST. The light below PROGRAMMED DEFROST will go on and "0" will show in the display window.
3. Set the defrosting time by following the "Programmed Defrosting Chart" on Pages 24 through 27.
4. Touch START. The oven will begin and the time will begin counting down in the display window. A tone will sound when the time is over and the oven will shut itself off.

NOTE: If you want to cook after using the PROGRAMMED DEFROST CYCLE, touch MEMORY/RECALL, then set the standing time from chart pp. 24—27 at 0 power level; touch MEMORY/RECALL and set the time and power level for cooking the thawed food. Up to five stages can be set when PROGRAMMED DEFROST is one of the stages.

EXAMPLE: To defrost two pounds of ground beef, use the PROGRAMMED DEFROST cycle for 9 minutes.

1. Touch CLEAR.
2. Touch PROGRAMMED DEFROST. The light below PROGRAMMED DEFROST will go on. The display window will show "0".

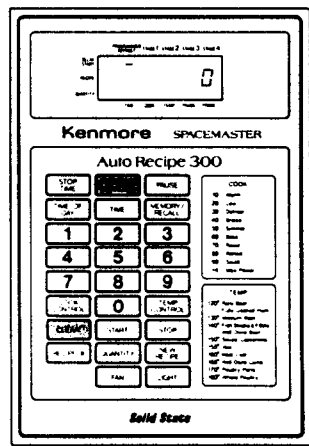

3. Set 9 minutes by touching "9", "0" and "0". "900" will show in the display window.

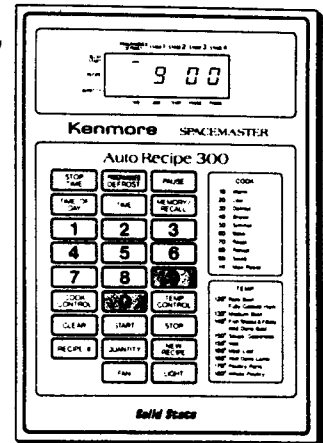

4. Touch START. The oven will begin to operate and time will begin to count down in the display window. A tone will sound when time is over and the oven will shut itself off.

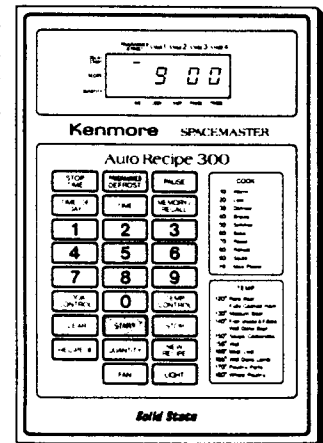

PROGRAMMED DEFROSTING CHART

The defrosting times in this chart have been made available specifically for use with the "Programmed Defrost by Time" feature.

PROGRAMMED DEFROSTING INSTRUCTIONS:

- Fish, seafood, meat or poultry can be thawed in their original closed package.
- Metal clip and pop-up timers may be left in poultry. Metal twistlers must be removed from bags. They may be replaced with rubber bands.
- Place food in a flat glass baking dish to catch drippings.
- Use the "Programmed Defrost" setting to thaw fish, seafood, meat and poultry, according to the times in the chart below. Thaw completely before cooking.
- Food should still be somewhat icy in the center when removed from the oven.
- The chart gives you standing times and standing techniques needed to complete the thawing process.

IMPORTANT NOTE: The defrosting power setting (power level 30) should not be confused with this "Programmed Defrost." The defrost cooking level is a low-energy setting used to cook foods that need slow, gentle cooking. Use the defrost cooking level to reheat many frozen convenience foods and also to defrost small bread items.

| CUT AND WEIGHT | PROGRAMMED DEFROSTING TIME | STANDING TIME | DIRECTIONS |
|-----------------------------------------------|----------------------------|------------------|---------------------------------------------------------------------------------------------------------------------------------------------------------------------------------------------|
| FISH AND SEAFOOD | | | |
| FISH Fish fillets 1 lb. 2 lbs. | 4 to 5 min. 5 to 6 min. | 5 min. 5 min. | Defrost in package on dish. Carefully separate fillets under cold water. Turn over once.* |
| Fish steaks 1 lb. | 4 to 5 min. | 5 min. | Defrost in package on dish. Carefully separate steaks under cold, running water. |
| Whole Fish 8 to 10 oz. 1½ lb. to 2 lbs. | 3 to 5 min. 4 to 6 min. | 5 min. 5 min. | Use a shallow dish; the shape of the fish determines size. The fish should be icy when removed. Finish at room temperature. Cover the head with aluminum foil. Turn over once.* |
| Lobster tails 8 oz. pkg. | 4 to 6 min. | 5 min. | Remove from package to baking dish. |
| Crab legs 8 to 10 oz. | 4 to 6 min. | 5 min. | Use a glass baking dish. Break the legs apart. Turn over once.* |
| Crabmeat 6 oz. | 3 to 4 min. | 5 min. | Defrost in package on dish. Break apart. Turn over once.* |

* Turning or stirring should be done in the middle of the defrosting cycle.

PROGRAMMED DEFROSTING CHART (Cont'd)

| CUT AND WEIGHT | PROGRAMMED DEFROSTING TIME | STANDING TIME | DIRECTIONS |
|-----------------------------------------------|-----------------------------|------------------|---------------------------------------------------------------------------------------------------------------------------------------------------------|
| Shrimp 1 lb. | 2 to 3 min. | 5 min. | Remove from package to dish. Spread loosely in baking dish and rearrange during thawing as necessary. |
| Scallops 1 lb. | 7 to 9 min. | 5 min. | Defrost in package, if in block; spread out on baking dish if in pieces. Turn over and rearrange during thawing as necessary. |
| Oysters 12 oz. | 2 to 3 min. | 5 min. | Remove from package to dish. Turn over and rearrange during thawing as necessary. |
| MEAT | | | |
| BEEF Ground beef 1 lb. 2 lbs. | 4 to 4½ min. 8 to 9 min. | 5 min. 5 min. | Turn over once.* Remove thawed portions with fork. Return remainder into oven to defrost. The best way to freeze ground beef is in a doughnut shape. |
| Pot roast, chuck Under 4 lbs. | 3 to 4 min. per lb. | 10 min. | Turn over once.* |
| Rib roast, rolled 3 to 4 lbs. | 5 to 7 min. per lb. | 30-45 min. | Turn over once.* |
| Rump roast 3 to 4 lbs. | 3 to 4 min. per lb. | 30 min. | Turn over once.* |
| Round steak | 3 to 4 min. per lb. | 5-10 min. | Turn over once.* |
| Flank steak | 3 to 4 min. per lb. | 5-10 min. | Turn over once.* |
| Sirloin steak ½ inch thick | 3 to 4 min. per lb. | 5-10 min. | Turn over once.* |
| Tenderloin steak | 4 to 5 min. per lb. | 10 min. | Turn over once.* |
| Stew beef 2 lbs. | 3 to 4 min. per lb. | 8-10 min. | Turn over once.* Separate. |
| LAMB Cubed for stew | 6 to 7 min. per lb. | 5 min. | Turn over once.* Separate. |
| Ground lamb Under 4 lbs. | 3 to 4 min. per lb. | 30-45 min. | Turn over once.* |
| Chops 1 inch thick | 4 to 6 min. per lb. | 15 min. | Turn over twice.* |
| Leg 5 to 8 lbs. | 3 to 4 min. per lb. | 15-20 min. | Turn over twice.* |

* Turning or stirring should be done in the middle of the defrosting cycle.

PROGRAMMED DEFROSTING CHART (Cont'd)

| CUT AND WEIGHT | PROGRAMMED DEFROSTING TIME | STANDING TIME | DIRECTIONS |
|-------------------------------------------------|--------------------------------------------|----------------------|-------------------------------------------------------------------------------------------------|
| MEAT | | | |
| PORK Chops ½ inch thick 1 inch thick | 4 to 5 min. per lb. 5 to 6 min. per lb. | 5–10 min. 10 min. | Separate chops halfway through defrosting time. |
| Spareribs, Country-style ribs 2 to 3 lbs. | 4 to 6 min. per lb. | 10 min. | Turn over once.* |
| Roast Under 4 lbs. | 3 to 4 min. per lb. | 30–45 min. | Turn over once.* |
| Bacon 1 lb. | 1½ to 2½ min. | 3–5 min. | Defrost until strips separate. |
| Sausage, bulk 1 lb. | 1½ to 2½ min. | 3–5 min. | Turn over once.* Remove thawed portions with fork. Return remainder into oven to defrost. |
| Sausage, links 1 lb. | 2 to 4 min. | 4–6 min. | Turn over once.* Defrost until pieces can be separated. |
| Hot dogs 1 lb. | 4 to 5 min. | 5 min. | |
| VEAL Roast 3 to 4 lbs. | 4 to 6 min. per lb. | 30 min. | Turn over once.* |
| Chops ½ inch thick | 3 to 5 min. per lb. | 20 min. | Turn over once.* Separate chops and continue defrosting. |
| VARIETY MEAT Liver 1 lb. | 4 to 5 min. | 10 min. | Turn over once.* |
| Tongue 1 lb. | 6 to 7 min. | 10 min. | Turn over once.* |

* Turning or stirring should be done in the middle of the defrosting cycle.

PROGRAMMED DEFROSTING CHART (Cont'd)

| CUT AND WEIGHT | PROGRAMMED DEFROSTING TIME | STANDING TIME | DIRECTIONS |
|------------------------------------------------------------------------|-----------------------------------------------|--------------------|--------------------------------------------------------------|
| POULTRY | | | |
| Chicken Whole 2 to 3 lbs. | 5 to 7 min. per lb. | 25-30 min. | Turn over once.* Immerse in cold water for standing time. |
| Cut up 2 to 3 lbs. | 4 to 5 min. per lb. | 10-15 min. | Turn over once.* Separate pieces when partially thawed. |
| TURKEY Whole Under 8 lbs. | 3 to 4 min. per lb. | 60 min. | Turn over once.* Immerse in cold water for standing time. |
| Breast Under 4 lbs. | 3 to 4 min. per lb. | 20 min. | Turn over once.* |
| Drumsticks 1 to 1½ lbs. | 4 to 5 min. per lb. | 15-20 min. | Turn over once.* Separate pieces when partially thawed. |
| Roast, boneless 2 to 4 lbs. | 2½ to 3 min. per lb. | 10 min. | Remove from foil pan. Cover with waxed paper. |
| CORNISH HENS Whole 1. 1 to 1½ lbs. 2. 1 to 1½ lbs. ea. | 10 to 11 min. per lb. 9 to 10 min. per lb. | 20 min. 20 min. | Turn over once.* Turn over once.* |

* Turning or stirring should be done in the middle of the defrosting cycle.

PROGRAMMED DEFROST BY TEMPERATURE

Power levels for defrosting are predetermined in this oven. Thus, the temperature probe can assist in proper defrosting of large dense items, such as casseroles, poultry and roasts.

1. Cover the corners of food with small pieces of aluminum foil.

Place the food to be defrosted on a rack in a baking dish. The baking dish will collect drippings from the food while the rack will prevent the food from soaking in the drippings and will help it defrost evenly.

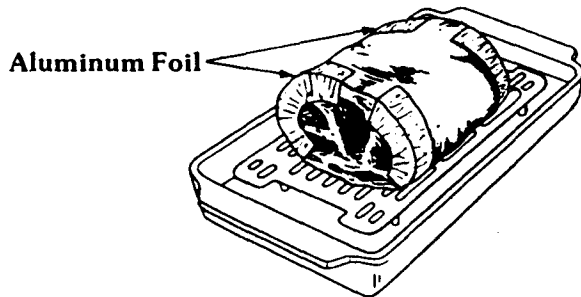

2. Adjust the slide grommet on the probe, so that the temperature probe can be placed into the food about 2-1/4" to 2-1/2" deep.

The probe should be placed horizontally about mid-height of the food and from the right-hand side. If the food is still hard and the temperature probe cannot be placed, use the probe spacer to make a 2-1/4" deep hole for the temperature probe. To avoid error, be sure the temperature probe is pushed to the bottom of the hole and do not place the temperature probe into fat, air pockets or areas near bones.

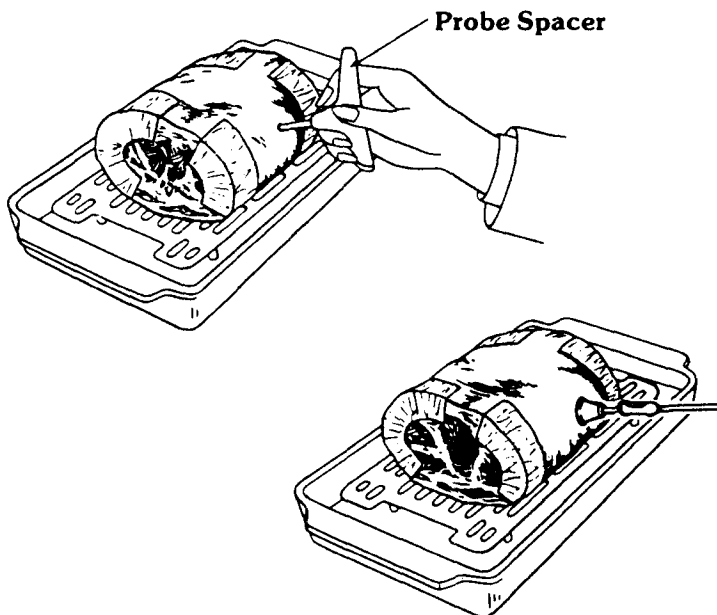

3. Plug temperature probe into socket on the side of the oven.

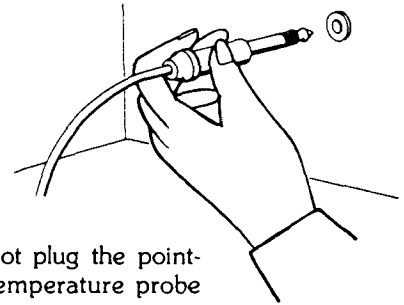

Caution: Do not plug the pointed end of the temperature probe into the socket.

4. Touch CLEAR.

5. Touch PROGRAMMED DEFROST. The light below PROGRAMMED DEFROST will go on and the display window will show "0".

6. Touch TEMP CONTROL.

The display window will show "dEF".

7. Touch START. The oven will start and the display window will show "dEF". A tone will sound for two seconds and the oven shuts itself off.

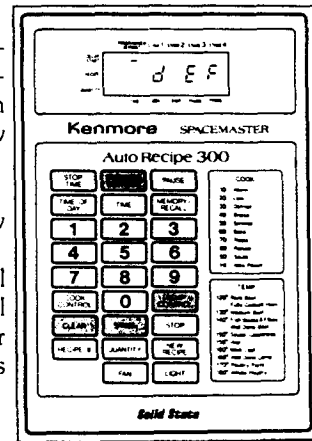

PRESET RECIPE COOKING

Auto Recipe 300 plus 3 Customer Programmable Recipes

300 recipes shown in the cookbook have been stored in this oven. By touching the recipe number corresponding to preset recipe, cooking can be done. These 300 recipes have been preset, so you can not erase or substitute them. You can program 3 more favorite recipes in Recipes # 301-303. See page 31 in this manual for programming new recipes.

•To cook one of 303 preset recipes, simply follow the steps below.

1. Touch CLEAR.
2. Touch RECIPE #.
"0" will show in the display window.
3. Touch the correct numbers of Recipe found in your Kenmore Microwave Cookbook.

Example: If you cook "French Onion Soup of Recipe # 25", touch "2" and then "5".
The display window shows "25".

Note: When you touch the numbers of Recipe # 301-303, the display window may flash, it means that no preset recipe has been stored in the oven for that recipe number.

4. Touch START
The oven will begin cooking, and the display window will show the time counting down.

Some preset cookings of "AUTO RECIPE 300" can cook up to 4th stage.

Notes:

- If "PAUSE" shows in the display window between stages, a special requirement (i.e. stirring, turning over, rotating and covering by following instructions in the cookbook) is needed.
- If "PAUSE" does not show in the display window, cooking in the stage cooking will start itself or the cooking has been completed.

Example: French Onion Soup of Recipe #25

The following program has been stored into the oven.

(Stage 1; HI, 6 minutes) (PAUSE)
(Stage 2; HI, 6 minutes) (PAUSE)
(Stage 3; HI, 1 minute) (PAUSE)
(Stage 4; HI, 8 minutes)

1. Touch RECIPE #, "2" and "5".
The light at the right of RECIPE in the display window will go on, "25" will show in the display window.

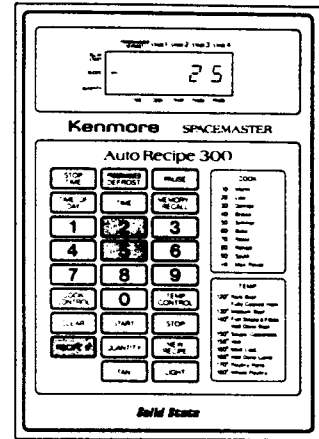

2. Touch START.
The first stage will begin. The light below STAGE 1 will go on and "600" will show in the display window. The oven will begin to cook at "HI" power level and the time will begin to count down in the display window. When the 6 minutes are over, a tone will sound and the oven will stop.

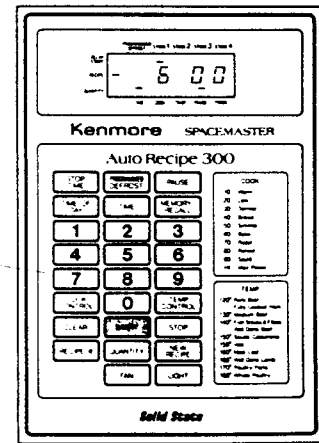

3. "PAUSE" will show in the display window.

At pause, stir by following the instructions in the cookbook.

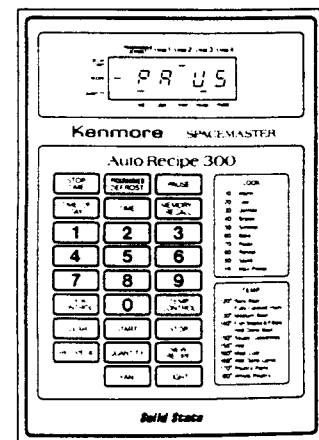

PRESET RECIPE COOKING (Cont'd)

Use of Quantity Key

- To increase Quantity of Preset Recipes.

The times, temperature and power levels for the 300 preset recipe cookings can not be changed. However the amount of food cooked in some preset recipes can be increased up to 5.9 times the Base Quantity which is preset in the oven. The light at the right of QUANTITY will turn on to indicate that you can use the QUANTITY key for that particular recipe.

To increase the quantity in these recipes, follow the steps below:

1. Touch CLEAR.
2. Touch RECIPE #.
3. Touch Numbers for the Preset Recipe.
4. Touch QUANTITY.
The light at the right of QUANTITY and "00" will show in the Display Window.
5. Touch numbers for the multiplication factor.
To double the recipe, touch "2" and "0".
To triple the recipe, touch "3" and "0".
6. Touch START.

Notes: The range of multiplication is 1.1 times to 5.9 times of the Base Quantity. Increment within the above range is 0.1.
Multiplication can be used in Recipes #, where the light at the right of QUANTITY shows in the display window.
When you set the multiplication of Base Quantity beyond the range of 1.1–5.9, the oven will not start even if you touch START.

Example: To cook three hot dogs per Recipe #49.

1. Touch CLEAR.
2. Touch RECIPE #.
3. Touch "4" and "9".
4. Touch QUANTITY.
5. Touch "3" and "0".
6. Touch START.

PROGRAMMING NEW RECIPES

In addition to the 300 preset recipes, you can program 3 more favorite recipes.

To store the desired recipes in the oven, follow these steps:

1. Touch CLEAR.
2. Touch NEW RECIPE.
"0" will show in the display window.
3. Touch RECIPE #.
4. Touch suitable numbers from 301 to 303.
Example: Touch "3", "0" and then "2".
"302" will show in the display window.
5. Preset your new recipes following the examples on pages 19 and 20.
6. Touch NEW RECIPE.
New recipe is now preset and the time of day will show in the display window.

Note: A recipe which has been stored in this manner, can be changed to a new recipe. If you want to change to a new recipe, the previously stored recipe is erased when a new recipe is entered over the old recipe.

Make a list of the recipe numbers and their recipes which are stored in this manner so that you can have easy reference for a later time.

UTENSILS

MATERIALS TO USE IN YOUR MICROWAVE OVEN

OVENPROOF GLASS

Ovenware (treated for high-intensity heat), such as utility dishes, bread dishes, pie plates, cake plates, liquid measuring cups, casseroles and bowls *without metallic trimming*.

CHINA

Bowls, cups, serving pieces, plates and platters *without metallic trimming*.

POTTERY

Dishes, cups, mugs and serving pieces *without metallic trimming*.

PLASTIC

Plastic wrap may be used as a cover. Lay the plastic wrap loosely over the dish and press it to the sides and fold back one corner for venting. The dish should be deep enough so that plastic wrap will not touch the food. As the food heats, it may cause the wrap to melt wherever it touches the food. Plastic dishes, cups, semirigid freezer containers and plastic bags are usable for short-time cooking. Use with care as some softening of the plastic may occur with heat from the food.

PAPER

Paper towels, waxed paper, paper napkins and paper plates are usable.

UTENSIL TEST: A simple way to find out if a utensil can be used for microwave cooking is to place it empty on the cooking tray. Close the door and set the time to 30 seconds (½ minute). Then touch START. If the utensil is warm to the touch at the end of this time, it should not be used for microwave cooking.

CAUTION: Always make sure that closed utensils are opened and plastic pouches of vegetables (or other food items) are pierced before cooking. Tightly closed utensils could explode.

MATERIALS TO AVOID USING IN YOUR MICROWAVE OVEN

METAL UTENSILS

Metal utensils are not recommended because the metal shields the food from microwave energy on the bottom and on the sides, causing uneven cooking results. *Metal utensils will also cause arcing and can damage the microwave oven.*

METAL DECORATION

Metal-trimmed or metal-banded dinnerware, casserole dishes, etc., should not be used. The metal trim interferes with normal cooking and may damage the dish.

CENTURA® TABLEWARE

Coming Glass does not recommend the use of its Centura® tableware or Corelle® closed handle cups for microwave cooking.

ALUMINUM FOIL

Large sheets or pieces of aluminum foil should be avoided because they will hinder cooking and *may cause harmful arcing*. However, smaller pieces may be used to cover areas such as poultry legs and wings. *Any aluminum foil used should be at least 1 inch from the side walls of oven.*

WOOD

Wooden bowls and boards will dry out when used in the microwave oven and may split or crack.

OTHER

Avoid using brown paper and cracked, flawed or chipped utensils, including ovenproof glassware.

CAUTION: Do not use metal ties on any paper or plastic bags; the ties become hot and could cause a fire.

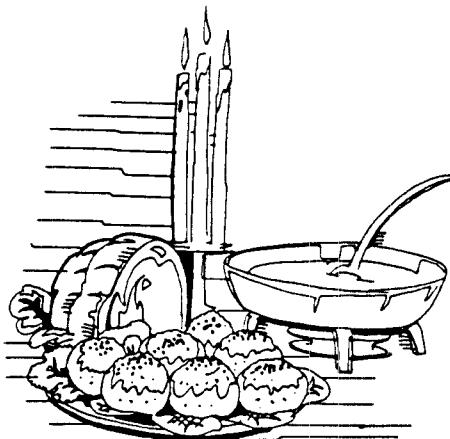

CARE AND CLEANING

Wipe the microwave inside and out, and the hood bottom cover outside with a soft cloth and a mild detergent solution. Then rinse and wipe dry. Use a chrome cleaner and polish on chrome, metal and aluminum surface. This should be done on a weekly basis-more often if needed. Never use rough cleaning powders or pads.

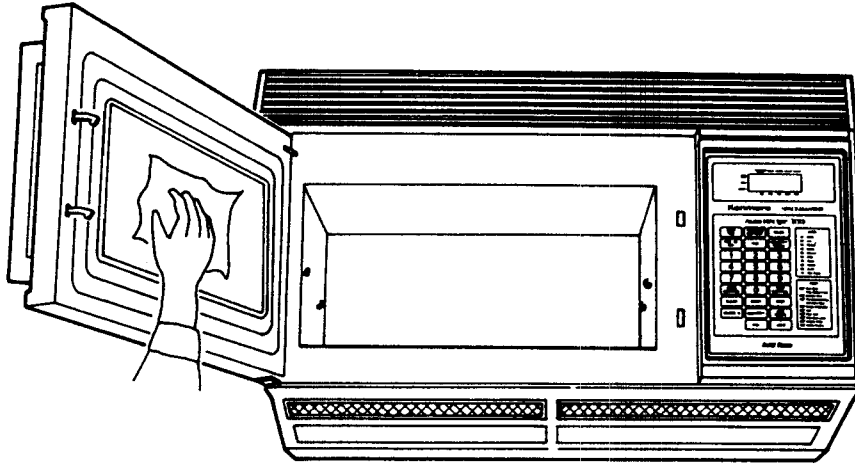

REMOVABLE PARTS

■ Temperature probe

After each use of the Temperature Probe, it must be removed from the socket. Use pot holder, as the wire, plug and sensor sections may be hot. Wipe food or liquid from sensor with damp cloth.

■ Glass tray and Metal rack

The glass tray and metal rack can be removed for cleaning at the sink. Wipe up spillovers with paper towel or cloth before removal of tray. Be careful not to chip or scratch the edges of the tray as this may cause the tray to break during use.

■ Stirrer shield

The oven inside top (stirrer shield) can be gently wiped in place or removed for washing at the sink. It rests in slots along the sides and in the rear of the oven and is held by three tabs in front. Carefully pull the front edge down and forward to remove. Wash only in warm (not hot) detergent water, rinse, and wipe dry. Avoid hitting or bending the metal stirrer blades, as this could cause uneven cooking or damage to the oven. To replace shield, slide it into the side and rear slots with cut-off at left rear corner, and carefully fit the front edge of the shield with the three tabs.

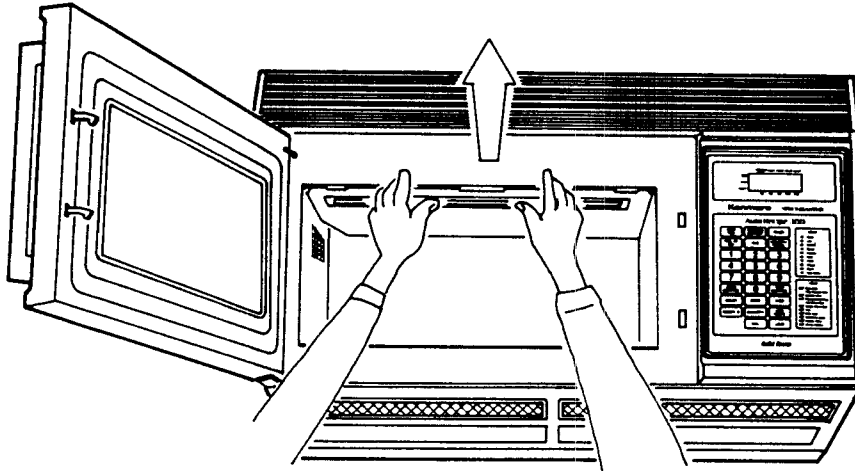

■ Exhaust filters

The two mesh exhaust filters on the hood bottom cover can be removed for washing in a sink. The filters are held by metal springs in the center of the hood bottom cover. To remove it, place a finger in the finger recess of the hood bottom cover and push it toward the center and pull down. Wash only in warm detergent water, rinse and wipe dry. Do not use ammonia for aluminum mesh filters. Do not run the hood fan without the filters.

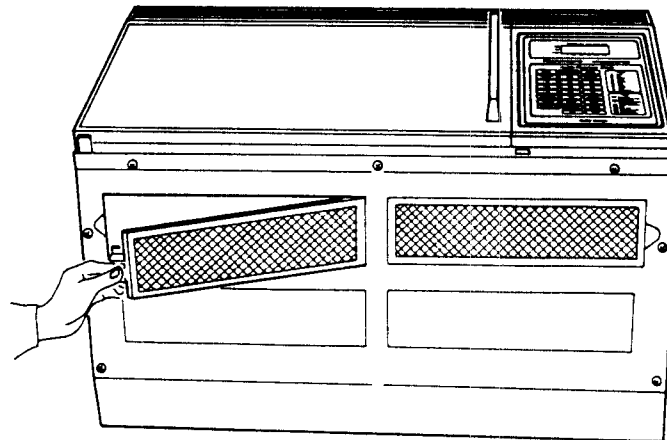

■ **Charcoal filter replacement (Required when unit is not vented to outside)**

The hood ventilation filters the air and discharges it back into kitchen through the Charcoal Filter. Stock No. 84126 which may be ordered at a Sears retail store or Sears catalog, if the exhaust air is not vented to the outside of house.

The Charcoal Filter behind the grillwork should be replaced every 6 to 12 months—more often if needed.

To replace the Charcoal Filter, open the door, grasp the grill work and pull it forward to remove. Slide the filter out from the filter bracket.

The used filter must be replaced with new one.

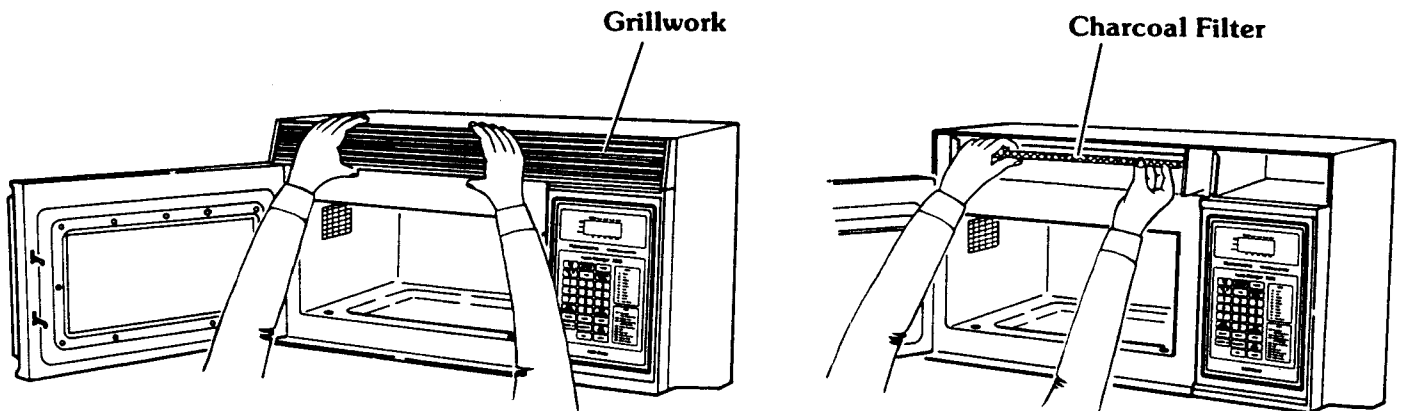

■ **Work light replacement**

Be sure the power is disconnected at the house circuit breaker, or by unplugging the power cord.

To replace the cooktop fluorescent lamp, the hood bottom cover must be removed.

Remove 7 screws from the front edge and the both side edges of the hood bottom cover.

To remove the lamp, hold the lamp ends, turn it about 1/4 turn and then pull it down.

The same wattage and size of the fluorescent lamp must be used for replacement.

To replace the lamp, put the lamp prongs into each socket and turn the lamp about 1/4 turn.

Put back the hood bottom cover by sliding it into the rear slots of the hood bottom cover and fastening 7 screws.

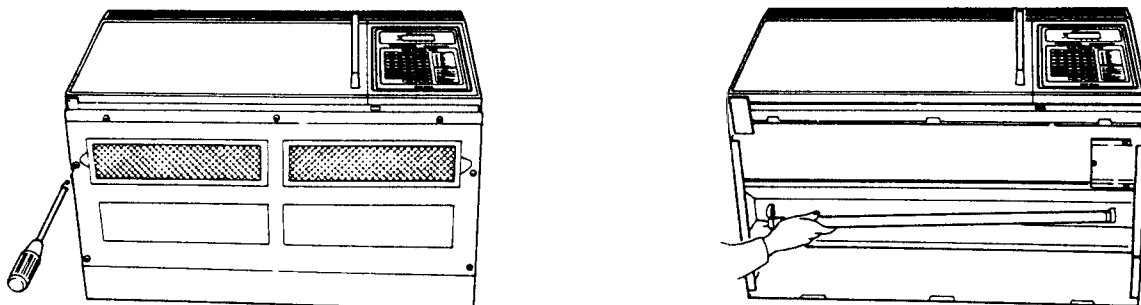

QUESTIONS AND ANSWERS

OPERATION

Q. What is wrong when the oven light will not glow during cooking or when the oven door is open?

- A. *There may be several reasons why the oven light will not glow. Perhaps:*
- *TIME has not been set.*
 - *The light bulb has burned out.*
 - *START has not been touched.*
-

Q. Why does steam come out of the grill work?

- A. *Steam is normally produced during cooking. The microwave oven has been designed to vent this steam out the grill work.*
-

Q. Will the microwave oven be damaged if it operates empty?

- A. *Yes. Never operate the oven empty or without the glass tray.*
-

Q. Does microwave energy pass through the viewing screen in the door?

- A. *No. The metal screen bounces the energy back into the oven cavity. The holes (or ports) are made to allow light to pass through. They do not let microwave energy pass through.*
-

Q. Why does the "beep tone" sound when a "pad" on the control panel is touched?

- A. *The "beep tone" sounds to assure that the setting is being properly entered.*
-

Q. Why does the display flash "0:00"?

- A. *This indicates that there has been a temporary loss of electrical power to the oven, and the TIME OF DAY must be reset.*
Prolonged loss of power can also result in loss of programmable recipes. Be sure they are recorded.
-

Q. Can my microwave oven be damaged if food is cooked for too long a period of time?

- A. *Like any other cooking appliance, it is possible to overcook food to the point of destruction which may result in the food creating smoke and even possible fire damage to the inside of the oven. It is always best to attend the oven while it is in the cooking process.*
-

Q. Why does the exhaust fan start when the FAN key is not touched?

- A. *High temperature air from the heating surface below can cause an overheating condition of the Oven, and may damage it. The exhaust fan will start automatically to cool off the oven and prevent damage to it.*
-

Q. When the oven is plugged into a wall outlet for the first time, it might not work properly. What is wrong?

- A. *Only when the oven is plugged in for the first time or when power resumes after a power interruption, the microcomputer used in the oven control assembly may temporarily become scrambled and fail to function as programmed.*
Unplug the oven from the 120-volt household outlet and then plug it back in. The microcomputer will be reset for proper function thereafter.
-

QUESTIONS AND ANSWERS (Cont'd)

FOODS

Q. What is wrong when baked foods have a hard, dry, brown spot?

A. A hard, dry, brown spot shows overcooking. Shorten the cooking or reheating time.

Q. Why do eggs sometimes pop?

A. When baking, frying or poaching eggs, the yolk may pop due to steam build-up inside the yolk membrane. To prevent this, simply pierce the yolk with a toothpick before cooking it.

CAUTION: Never microwave cook eggs in the shell.

Q. Why are scrambled eggs sometimes a little dry after cooking?

A. Eggs dry out if they are overcooked. Though the same recipe is used each time, one may need to vary the cooking time for one of these reasons:

- Eggs vary in size.
 - Eggs are at room temperature one time and at refrigerator temperature another time.
 - The shapes of utensils vary, thereby making it necessary to vary the cooking time.
 - Eggs continue cooking during standing time.
-

Q. Is it possible to pop corn in a microwave oven?

A. Popping corn in a microwave oven is not recommended. Microwaves pop too few kernels to make the technique successful. Longer cooking does not yield more popped corn. It can cause fire or cause the cooking dish to become too hot to handle or to break.

Microwave-popping devices are available. While safe to use, they usually do not give results equal to regular popping methods. If they are used, carefully follow the instructions which come with the popping device and never leave the oven unattended while popping corn.

CAUTION: Never use a paper bag for popping corn.

Q. What is wrong when three potatoes bake thoroughly and the fourth one is still not cooked?

A. The fourth potato may be slightly heavier than the others and should be cooked 30 to 60 seconds longer. Remember to allow space around each potato when baking. Also, for more even cooking, put potatoes in a circle.

Q. Why do baked apples sometimes burst during cooking?

A. The peeling has not been removed from the top half of each apple to allow for expansion of the interior of the apple during cooking. As in regular cooking methods, the interior of the apple expands during the cooking process.

Q. How are boil-overs avoided?

A. When cooking foods that tend to boil over, use a larger utensil than usual for cooking. If you open the oven door or touch STOP, the food will stop boiling. (Remember to touch START again after closing the door to restart the cooking cycle.)

Q. Why is a standing time recommended after microwave cooking is over?

A. Standing time is recommended after microwave cooking is over. This is to allow foods to continue cooking evenly throughout for a few moments after the actual microwave oven cooking cycle. The amount of standing time depends upon the density of the food.

BEFORE CALLING FOR SERVICE

You can often correct operating problems yourself. If your microwave oven fails to work properly, locate the operating problem in the chart below and try the solutions marked for each problem.

If the microwave oven still does not work properly, contact the nearest Sears Service Center. Sears Service Centers are fully equipped to handle your service requirements.

PROBLEM

| | | | | | | | | | | | | | | | | | | | | |
|-----------------------|---|---|---|---|---|---|---|--|--|--|--|--|--|--|--|--|--|--|--|--|
| Oven Will Not Start | X | X | X | X | | | | | | | | | | | | | | | | |
| Arcing or Sparking | | | | | X | X | X | | | | | | | | | | | | | |
| Time of Day Incorrect | | | | | | | | | | | | | | | | | | | | |
| Probe Light Flashes | | | | | | | | | | | | | | | | | | | | |
| Unevenly Cooked Foods | | | | | X | | | | | | | | | | | | | | | |
| Overcooked Foods | | | | | | | | | | | | | | | | | | | | |
| Undercooked Foods | | | | | X | X | | | | | | | | | | | | | | |
| Improper Defrosting | | | | | X | | | | | | | | | | | | | | | |

SOLUTION

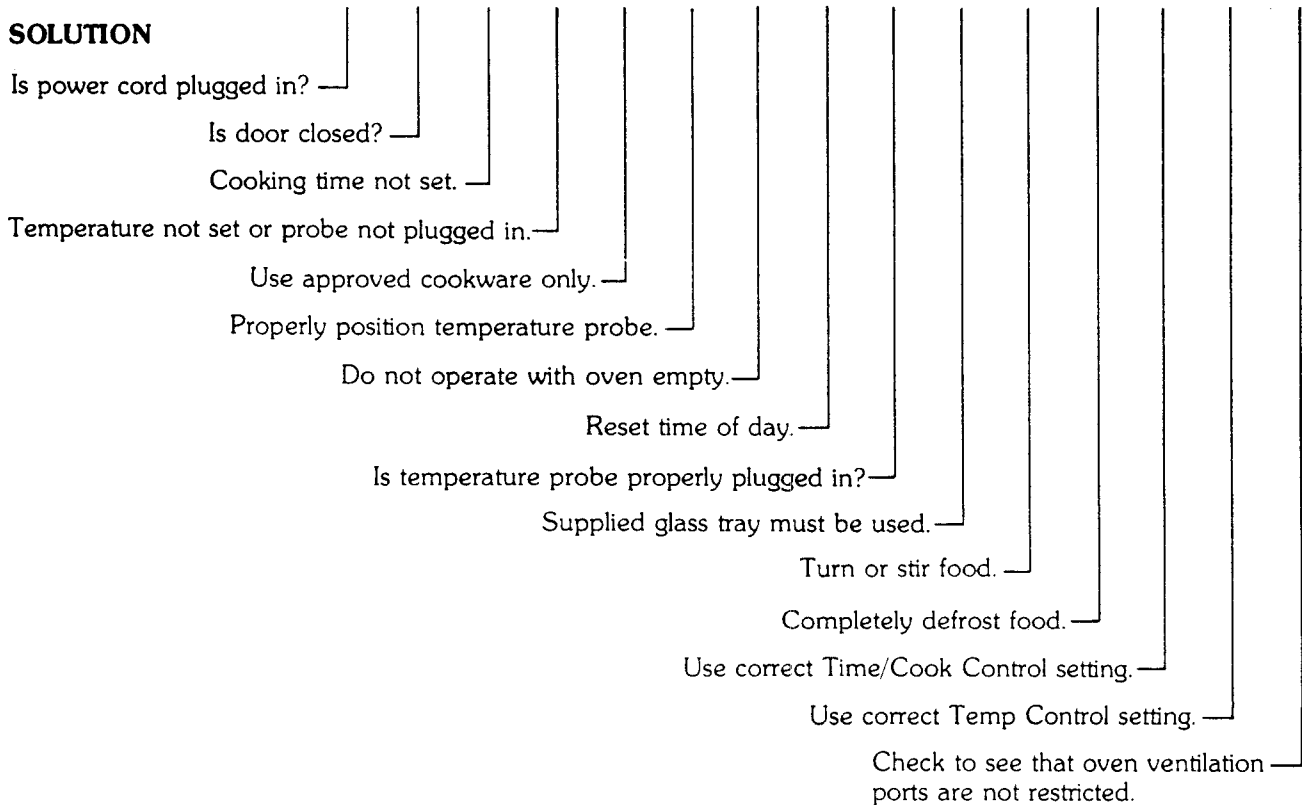

SEARS SERVICE

“WE SERVICE WHAT WE SELL”

“We Service What We Sell” is our assurance to you that you can depend on Sears for service because Sears Service is nationwide.

Your Sears Kenmore Microwave Oven has added value when you consider that Sears has a service unit near you, staffed by Sears Trained Technicians — professional technicians specifically trained on Sears Kenmore Microwave Ovens, having the parts, tools and equipment to insure that we meet our pledge to you — “We Service What We Sell!”

TO FURTHER ADD TO THE VALUE OF YOUR MICROWAVE OVEN, BUY A SEARS MAINTENANCE AGREEMENT.

Sears Kenmore Microwave Ovens are designed, manufactured, and tested for years of dependable operation. Yet, any modern appliance may require service from time to time. A Sears Maintenance Agreement is more than an extension of the Warranty.

It provides complete protection from unexpected repair bills and undue inconvenience. It assures you of maximum efficiency from your microwave oven.

Here's a comparative Warranty and Maintenance Agreement chart showing you the benefits of a Sears Microwave Oven Maintenance Agreement.

| YEARS OF OWNERSHIP COVERAGE | 1st Yr. | 2nd Yr. thru 5th Yr. |
|----------------------------------------------------------|---------|----------------------|
| 1. Replacement of defective parts other than magnetron | W | MA |
| 2. Replacement of magnetron | W | W |
| 3. Annual preventative maintenance check at your request | MA | MA |

W—WARRANTY
MA—MAINTENANCE AGREEMENT

Contact your Sears salesperson or local Sears Service Center today and purchase a Sears Maintenance Agreement.

Sears

USE & CARE
MANUAL

STOCK NO.
85941

Kenmore

MICROWAVE OVEN

WARRANTY

FULL ONE YEAR WARRANTY ON MICROWAVE OVEN

FOR ONE YEAR FROM THE DATE OF PURCHASE, IF THIS KENMORE MICROWAVE OVEN FAILS DUE TO A DEFECT IN MATERIAL OR WORKMANSHIP, SEARS WILL REPAIR IT, FREE OF CHARGE.

FULL FIVE YEAR WARRANTY ON THE MAGNETRON

FOR FIVE YEARS FROM THE DATE OF PURCHASE, IF THE MAGNETRON IN THIS KENMORE MICROWAVE OVEN FAILS DUE TO A DEFECT IN MATERIAL OR WORKMANSHIP, SEARS WILL REPAIR IT, FREE OF CHARGE.

THE ABOVE WARRANTY COVERAGE APPLIES ONLY TO MICROWAVE OVENS WHICH ARE USED FOR PRIVATE HOUSEHOLD PURPOSES.

WARRANTY SERVICE IS AVAILABLE BY SIMPLY CONTACTING THE NEAREST SEARS STORE OR SERVICE CENTER IN THE UNITED STATES.

THIS WARRANTY APPLIES ONLY WHILE THIS PRODUCT IS IN USE IN THE UNITED STATES.

THIS WARRANTY GIVES YOU SPECIFIC LEGAL RIGHTS, AND YOU MAY ALSO HAVE OTHER RIGHTS WHICH VARY FROM STATE TO STATE.

**SEARS, ROEBUCK AND CO.
DEPT. 698/731A, SEARS TOWER, CHICAGO, IL. 60684**

Sears, Roebuck and Co., Chicago, IL. 60684, U.S.A.

Free Manuals Download Website

<http://myh66.com>

<http://usermanuals.us>

<http://www.somanuals.com>

<http://www.4manuals.cc>

<http://www.manual-lib.com>

<http://www.404manual.com>

<http://www.luxmanual.com>

<http://aubethermostatmanual.com>

Golf course search by state

<http://golfingnear.com>

Email search by domain

<http://emailbydomain.com>

Auto manuals search

<http://auto.somanuals.com>

TV manuals search

<http://tv.somanuals.com>