



Model: 87039

Microwave Oven Owner's Manual

1. READ these instructions carefully before installing and operating the oven. Keep them for further reference.
2. Record in the space below the "SERIAL NO." found on the nameplate on your oven and retain this information for future reference.

SERIAL NO.:

**PRECAUTIONS TO AVOID POSSIBLE EXPOSURE TO
EXCESSIVE MICROWAVE ENERGY**

1. Do not attempt to operate this oven with the door-open since open-door operation can result in harmful exposure to microwave energy. It is important not to defeat or tamper with the safety interlocks.
2. Do not place any object between the oven front face and the door or allow soil or cleaner residue to accumulate on sealing surfaces.
3. Do not operate the oven if it is damaged. It is particularly important that the oven door close properly and that there is no damage to the:
 - a) Door (bent),
 - b) Hinges and latches (broken or loosened),
 - c) Door seals and sealing surfaces.
4. The oven should not be adjusted or repaired by anyone except properly qualified service personnel.

CONTENT

PRECAUTIONS TO AVOID POSSIBLE EXPOSURE TO EXCESSIVE MICROWAVE ENERGY 1

IMPORTANT SAFETY INSTRUCTIONS2

GROUNDING INSTRUCTIONS 3

UTENSILS GUIDE.....4

COOKING TECHNIQUES6

BEFORE YOU CALL FOR SERVICE 7

SPECIFICATIONS.....7

PART NAMES7

CONTROL PANEL 8

OPERATION INSTRUCTIONS.....9

Setting the clock.....9

Setting the over timer 9

Setting a cooking program 9

Speed defrost.....10

Cook by weight.....10

Defrost by weight 11

Setting child lock 11

QUICK COOK SETTINGS 11

POPCORN 11

BAKED POTATO 11

PIZZA 12

BEVERAGE 12

FROZEN DINNER.....12

REHEAT 12

CLEANING AND CARE 13

IMPORTANT SAFETY INSTRUCTIONS

When using electrical appliances, basic safety precautions should be followed, including the following:

WARNING - To reduce the risk of burns, electric shock, fire, and injury to persons or exposure to excessive microwave energy:

1. Read all instructions before using the appliance.
2. Read and follow the specific "PRECAUTIONS TO AVOID POSSIBLE EXPOSURE TO EXCESSIVE MICROWAVE ENERGY" on page 1.
3. This appliance must be grounded. Connect only to properly grounded outlet. See "grounding instructions" on page 3.
4. Install or locate this appliance only in accordance with the provided installation instructions.
5. Some products such as whole eggs and sealed containers -for example, closed glass jars- are able to explode and should not be heated in this oven.
6. Use this appliance only for its intended use as described in this manual. Do not use corrosive chemicals or vapors in this appliance. This type of oven is specifically designed to heat, cook, or dry food. It is not designed for industrial or laboratory use.
7. As with any appliance, close supervision is necessary when used by children.
8. To reduce the risk of fire in the oven cavity:
 - ✧ Do not overcook food. Carefully attend appliance when paper, plastic, or other combustible materials are placed inside the oven to facilitate cooking.
 - ✧ Remove wire twist-ties from paper or plastic bags before placing bag in oven.
 - ✧ If materials inside the oven should ignite, keep oven door closed, turn oven off, and disconnect the power cord or shut off power at the fuse or circuit breaker panel.
 - ✧ Do not use the cavity for storage purposes. Do not leave paper products, cooking utensils or food in the cavity when not in use.
9. Liquids, such as water, coffee, or tea can be overheated beyond the boiling point without appearing to be boiling due to surface tension of the liquid. Visible bubbling or boiling when the container is removed from the microwave oven is not always present. **THEIS COULD RESULT IN VERY HOT LIQUIDS SUDDENLY BOILING OVER WHEN A SPOON OR OTHER UTENSIL IS INSERTED INTO THE LIQUID.** To reduce the risk of injury to person:
 - ✧ Do not overheat the liquid.
 - ✧ Stir the liquid both before and halfway through heating it.
 - ✧ Do not use straight-sided containers

- with narrow necks.
- ✧ After heating, allow the container to stand in the microwave oven for a short time before removing the container.
 - ✧ Use extreme care when inserting a spoon or other utensil into the container.
10. Do not heat oil or fat for deep-frying. It is difficult to control the temperature of oil in microwave oven.
 11. Pierce foods with heavy skins such as potatoes, whole squash, apples and chestnuts before cooking.
 12. The contents of feeding bottles and baby jars should be stirred or shaken and the temperature should be checked before serving in order to avoid burns.
 13. Cooking utensils may become hot because of heat transferred from the heated food. Potholders may be needed to handle the utensil.
 14. Do not cover or block any openings on the appliance.
 15. Do not store or use this appliance outdoors. Do not use this product near water, for example, near a kitchen sink, in a wet basement, near a swimming pool, or similar locations.
 16. Do not operate this appliance if it has a damaged cord or a plug, if it is not working properly or if it has been damaged or dropped.
 17. Do not immerse cord or plug in water. Keep cord away from heated surface. Do not let cord hang over edge of table or counter.
 18. Use only thermometers, which are specifically designed for use in microwave ovens.
 19. Do not operate any heating or cooking appliance beneath this appliance.
 20. Be certain the glass tray and roller rings are in place when you operate the oven
 21. This appliance should be serviced only by qualified service personnel contact nearest authorized service facility for examination, repair, or adjustment.

GROUNDING INSTRUCTIONS

This appliance must be grounded. In the event of an electrical short circuit, grounding reduces risk of electric shock by providing an escape wire for the electric current. The appliance is equipped with a cord having a grounding wire with a grounding plug. The plug must be plugged into an outlet that is properly installed and grounded.

WARNING: Improper use of the grounding plug can result in a risk of electric shock.

Electrical Requirements

The electrical requirements are a 120 volt 60 Hz, AC only, 15 amp. It is recommended that a separate circuit serving only the oven be provided. The oven is equipped with a 3-prong grounding plug. It must be plugged into a wall receptacle that is properly installed and grounded.

Power Supply Cord

1. A short power supply cord is provided to reduce the risks resulting from becoming entangled in or tripping over a longer cord.
2. Longer cord sets or extension cords are available and may be used if care is exercised in their use.
3. If long cord or extension cord is used:
 - a) The marked electrical rating of the cord set or extension cord should be at least as great as the electrical rating of the appliance.
 - b) The extension cord must be a grounding-type 3-wire cord, and The longer cord should be arranged so that it will not drape over the counter top or table top where it can be pulled on by children or tripped over unintentionally.

Notes:

1. If you have any questions about the grounding or electrical instructions, consult a qualified electrician or service person.
2. Neither Galanz nor the dealer can accept any liability for damage to the oven or personal injury resulting from failure to observe the electrical connection procedures.

Radio or TV Interference

Should there be any interference caused by the microwave oven to your radio or TV, check that the microwave oven is on a different circuit, relocated the radio or TV as far away from the oven as feasible or check position and signal of receiving antenna.

UTENSILS GUIDE

This section lists which utensils can be used in the microwave, which ones have limited use for short periods, and which ones should not be used in the microwave.

Recommended

- Microwave browning dish — Use to brown the exterior of small items such as steaks, chops, or pancakes. Follow the directions provided with your browning dish.
- Microwaveable plastic wrap — Use to retain steam. Leave a small opening for some steam to escape and avoid placing it directly on the food.
- Paper towels and napkins — Use for short-term heating and covering; These absorb excess moisture and prevent spattering. Do not use recycled paper towels, which may contain metal and could ignite.
- Glass and glass-ceramic bowls and dishes — Use for heating or cooking.
- Paper plates and cups — Use for short-term heating at low temperatures. Do not use recycled paper, which may contain metal and could ignite.
- Wax paper — Use as a cover to prevent spattering.

- Thermometers — Use only those labeled “Microwave Safe” and follow all directions. Check the food in several places. Conventional thermometers may be used on microwave food once the food has been removed from the oven.

Limited Use

- Aluminum foil — Use narrow strips of foil to prevent overcooking of exposed areas. Using too much foil can damage your oven, so be careful.
- Ceramic, porcelain, and stoneware — Use these if they are labeled “Microwave Safe”. If they are not labeled, test them to make sure they can be used safely.
- Plastic — Use only if labeled “Microwave Safe”. Other plastics can melt.
- Straw, wicker, and wood — Use only for short-term heating, such as warming dinner rolls for a few seconds. Baskets and bowls may be flammable.

Not Recommended

- Glass jars and bottles — Regular glass is too thin to be used in a microwave. It can shatter and cause damage and injury.
- Paper bags — These are a fire hazard, except for popcorn bags that are designed for microwave use.
- Styrofoam plates and cups — These can melt and leave an unhealthy residue on food.
- Plastic storage and food containers — Containers such as margarine tubs can melt in the microwave.
- Metal utensils — These can damage your oven. Remove all metal before cooking.

Note: Should you wish to check if a dish is safe for microwaving, place the empty dish in the oven and microwave on HIGH for 30 seconds. A dish which becomes very hot should not be used.

Save These Instructions

COOKING TECHNIQUES

Your microwave makes cooking easier than conventional cooking, provided you keep these considerations in mind:

Stirring

Stir foods such as casseroles and vegetables while cooking to distribute heat evenly. Food at the outside of the dish absorbs more energy and heats more quickly, so stir from the outside to the center. The oven will turn off when you open the door to stir your food.

Arrangement

Arrange unevenly shaped foods, such as chicken pieces or chops, with the thicker, meatier parts toward the outside of the turntable where they receive more microwave energy. To prevent overcooking, place delicate areas, such as asparagus tips, toward the center of the turntable.

Shielding

Shield food with narrow strips of aluminum foil to prevent overcooking. Areas that need shielding include poultry wing-tips, the ends of poultry legs, and corners of square baking dishes. Use only small amounts of aluminum foil. Larger amounts can damage your oven.

Turning

Turn foods over midway through cooking to expose all parts to microwave energy. This is

especially important with large foods such as roasts.

Standing

Foods cooked in the microwave build up internal heat and continue to cook for a few minutes after heating stops. Let foods stand to complete cooking, especially foods such as cakes and whole vegetables. Roasts need this time to complete cooking in the center without overcooking the outer areas. All liquids, such as soup or hot chocolate, should be shaken or stirred when cooking is complete. Let liquids stand a moment before serving. When heating baby food, stir well at removal and test the temperature before serving.

Adding moisture

Microwave energy is attracted to water molecules. Food that is uneven in moisture content should be covered or allowed to stand so that the heat disperses evenly. Add a small amount of water to dry food to help it cook.

Save These Instructions

BEFORE YOU CALL FOR SERVICE

If the oven fails to operate:

- A) Check to ensure that the oven is plugged in securely. If it is not, remove the plug from the outlet, wait 10 seconds and plug it in again securely.
- B) Check for a blown circuit fuse or a tripped main circuit breaker. If these seem to be operating properly, test the outlet with another appliance.
- C) Check to ensure that the control panel is programmed correctly and the timer is set.
- D) Check to ensure that the door is securely closed engaging the door safety lock system. Otherwise, the microwave energy will not flow into the oven.

IF NONE OF THE ABOVE RECTIFIES THE SITUATION, THEN CONTACT A QUALIFIED TECHNICIAN. DO NOT TRY TO ADJUST OR REPAIR THE OVEN YOURSELF.

SPECIFICATIONS

Power Consumption:	120V~60Hz, 1050W(Microwave)
Output	700W
Operation Frequency	2450MHz
Outside Dimensions (H×W×D)	10 5/16×17 13/16×12 11/16 inches.
Oven Cavity Dimensions (H×W×D):	8 1/4×12 3/8×12 3/8 inches.
Oven Capacity	0.7 cu.ft.
Cooking Uniformity	Turntable System
Net Weight	Approx. 23.8lbs.

PART NAMES

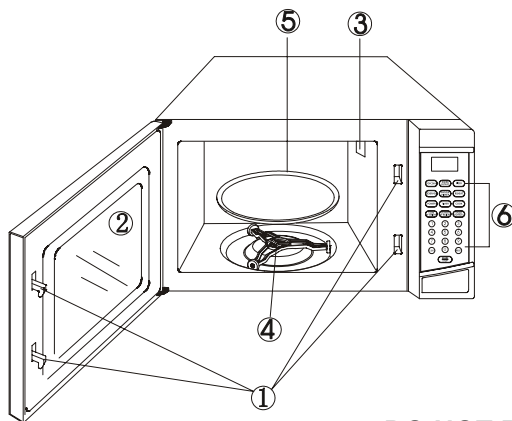

1. Door Safety Lock System
2. Oven Window
3. Wave Guide
4. Turntable Roller
5. Glass Tray
6. Control Panel

DO NOT REMOVE THE CARDBOARD OVEN AIR VENT COVER THAT IS INSIDE THE MICROWAVE!

CONTROL PANEL



- **DISPLAY**

Cooking time, power, indicators and present time are displayed.

- **QUICK COOK BUTTONS**

Instant settings to cook popular foods

- **NUMBER PADS (0-9)**

Touch to set times or weights

- **POWER**

Use to set power level. To check power level during time cooking, touch POWER pad.

- **TIMER**

Timer functions independently, even while a cooking program is in process.

- **COOK**

Use for multi-stage cooking. Enables cooking at multiple power and time settings automatically.

- **COOK BY WEIGHT**

Programmed cooking based on the weight of the foods to be cooked.

- **DEFROST BY WEIGHT**

Programmed defrosting based on the weight of the foods to be defrosted.

- **SPEED DEFROST**

Quick defrost function that alternates defrost and stand times to quickly and effectively defrost foods.

- **CLOCK**

Use to set the time of day or recall the time of day.

- **RESET**

Clears all previous settings.

- **START/STOP**

Touch to start or stop cooking.

OPERATION INSTRUCTIONS

SIGNALS DURING OVEN SETTINGS

ONE SIGNAL: Oven accepts the entry.

TWO SIGNALS: Oven does not accept the entry, check and try again.

SETTING THE CLOCK

1. Touch CLOCK pad.
2. Use the number pads to enter the correct time. You must touch at least three numbers to set the clock (one for hour and two for minutes).
3. Touch CLOCK pad again.

NOTE:

- This is a 12 hour clock. When the oven is first plugged in or when power resumes after a power interruption, the display will show ENTER CLOCK TIME. If you prefer to not have the clock displayed, touch RESET.
- You can check the clock time while cooking is in progress by touching the CLOCK pad.

SETTING THE OVER TIMER

1. Touch TIMER.
2. Enter the amount of time by touching the number pads. Digit time is in minutes and seconds and set left to right. Set one digit (a 5 for 5 seconds) or up to four digits (2405 for 24 minutes, 5 seconds).
3. Touch START/STOP.

NOTE:

- Time countdown can be seen in display for 3 seconds before clock or cooking time is returned to display.
- Touch TIMER and then touch RESET to cancel TIMER during timing process.

SETTING A COOKING PROGRAM

A. One-stage Cooking

1. Use the number pads to set a cooking time. You can set a cooking time from one second to 99 minutes and 99 seconds.
2. If you want to set a power level other than 100% power, touch POWER, then
3. Use the number pads to enter the power level. You can set the power level from 1 to 9.
4. Touch START/STOP to start cooking.

Use single digits to set a cooking power level:

Number pad	Cooking power
9	90%
8	80%
7	70%
6	60%
5	50%
4	40%
3	30%
2	20%
1	10%

B. Two-stage Cooking

Some recipes require different stages of cooking at different temperatures.

1. SET STAGE 1:

Follow steps 1 and 2 in "One-stage Cooking".
DO NOT TOUCH START

2. SET STAGE 2:

Touch COOK then enter proper cooking time

and (lower) power level. (Most 2-stage recipes use lower power for second stage.)

3. Touch START/STOP.

NOTE:

- After stage 1 time has elapsed, one signal sounds, signaling the beginning of stage 2.
- After total time has elapsed, 4 signals sound and END appears in display. Touch RESET or open oven door to clear END before starting another cooking function.

SPEED DEFROST

1. Touch SPEED DEFROST.
2. Enter desired defrosting time by touching correct number pads.

Digital timer sets minutes and seconds from left to right so a single digit can be set (5 for 5 seconds) or up to 4 digits (2405 for 24 minutes 5 seconds).

3. Touch START/STOP.

NOTE:

- After time has elapsed four signals sound and END appears in display. Touch RESET pad or open the door to clear END before starting another cooking function.
- After setting SPEED DEFROST, oven can be programmed to automatically switch to one or two-stage cooking.
- For speed defrost and one stage cooking, follow steps above. Before touching START/STOP, touch COOK, enter time and power level and then touch START/STOP.
- For speed defrost and two stage cooking, follow steps above. Before touching START/STOP, enter two-stage cooking programs.

COOK BY WEIGHT

1. Touch COOK BY WEIGHT.

2. Enter the one digit code by touching the correct number pad.
3. Enter weight.
4. Touch START/STOP.

Cook By Weight Code Description

CODE	TYPE	MAX WEIGHT
1	Beef	5 lb. 16 oz.
2	Mutton	5 lb. 16 oz.
3	Pork	5 lb. 4 oz.

Note:

- Meat must be defrosted and at refrigerated temperature.
- Weight must be in pounds and ounces.
- Ounce weights less than 10 must be preceded by a 0. If label gives weight in pounds only, change the fraction of a pound to ounces using the following chart.

Converting Fractions of a Pound to Ounces

Fractions of a pound	Ounces
Less than .03	0
.03 to .09	1
.10 to .15	2
.16 to .21	3
.22 to .27	4
.28 to .34	5
.35 to .40	6
.41 to .46	7
.47 to .53	8
.54 to .59	9
.60 to .65	10
.66 to .71	11
.72 to .78	12
.79 to .84	13
.85 to .90	14
.91 to .97	15
above .97	go to next even

- Turn meat over when oven signals twice. Touch START/STOP to resume cooking.
- After total cooking time, 4 signals sound and END appears in display. Touch RESET or open oven door to clear END before starting another cooking function.
- Let meat stand few minutes before carving.

DEFROST BY WEIGHT

1. Touch DEFROST BY WEIGHT pad.
2. Enter weight.
3. Touch START/STOP pad.

NOTE:

- Weight must be in pounds and ounces. Ounce weights less than 10 must be preceded by a 0. If label gives weight in pounds only, change the fraction of a pound

to ounces using the chart given above.

- Turn food over when oven signals twice. Touch START/STOP pad to resume defrosting.
- After total defrosting time, 4 signals sound and END appears in display. Touch RESET or open oven door to clear END before starting another cooking function.

SETTING CHILD LOCK

The safety lock prevents unsupervised operation by children.

To set, press and hold RESET for 3 seconds. LOCK is indicated on the display.

To cancel, press and hold RESET for 3 seconds. LOCK indication disappears.

QUICK COOK SETTINGS

The QUICK COOK settings allow you to cook or reheat food automatically without entering power level or time.

For smaller portions, simply touch the applicable pad and START/STOP. For larger portions, push the pad twice.

FROZEN DINNER, BAKED POTATO and BEVERAGE allow you to cook multiple amounts of the same food. Simply touch pad once, and ENTER AMT appears in the display. Enter the amount of servings and start.

POPCORN

For a 3.5 oz. bag of microwave popcorn:

1. Touch POPCORN.
2. Touch START/STOP.

NOTE: To change the preset POPCORN

time: Touch POPCORN twice. ENTER TIME appears in display. Touch number pads to enter minutes and seconds. Touch START/STOP. This new cooking time will remain whenever you use the POPCORN setting.

BAKED POTATO

For potatoes (4 to 6 oz./entries):

1. Touch POTATO once.
2. Enter number of potatoes by touching number pads from 1 to 4.
3. Touch START/STOP.

For the large potatoes (6 to 8 oz./entries):

1. Touch POTATO twice.
2. Enter number of potatoes by touching number pads from 1 to 4.
3. Touch START/STOP.

PIZZA

Reheating a slice of pizza:

1. Touch PIZZA once.
2. Touch START/STOP.

Heating a whole frozen pizza:

1. Touch PIZZA twice.
2. Touch START/STOP.

BEVERAGE

For beverage (5 to 7 oz./cup):

1. Touch BEVERAGE once.
2. Enter number of cups by touching number pads from 1 to 4.
3. Touch START/STOP.

For the beverage (9 to 11 oz./cup):

1. Touch BEVERAGE twice.
2. Enter number of mugs by touching number pads from 1 to 4.
3. Touch START/STOP.

FROZEN DINNER

For one or two small frozen dinners (7-9 oz./share):

1. Touch FROZEN DINNER once.
2. For 1 entree, touch number pad "1". For 2 entrees, touch the number pad "2".
3. Touch START/STOP pad.

Microwaving one large frozen dinner (10-12 oz./share):

1. Touch FROZEN DINNER twice.
2. For 1 entree, just touch START/STOP. For 2 entrees, touch the number pad "2".
3. Touch START/STOP.

REHEAT

1. Touch REHEAT pad.
2. Touch START/STOP.

NOTE:

This setting lets you reheat a dinner plate of chilled leftovers with good results.

CLEANING AND CARE

1. When cleaning surfaces of door and oven that comes together on closing the door, use only mild, nonabrasive soaps, or detergents applied with a sponge or soft cloth.
2. Turn off the oven and remove the power plug from the wall socket before cleaning.
3. Keep the inside of the oven clean. When food splatters or spilled liquids adhere to oven walls, wipe with a damp cloth. Mild detergent may be used if the oven gets very dirty. Avoid the use of spray and other harsh cleaners as they may stain, streak or dull the door surface.
4. The outside surfaces should be cleaned with a damp cloth. To prevent damage to the operating parts inside the oven, water should not be allowed to seep into the ventilation openings.
5. Wipe the window on both sides with a damp cloth to remove any spills or spatters.
6. Do not allow the control panel to become wet. Clean with a soft, damp cloth. When cleaning the control panel, leave oven door open to prevent oven from accidentally turning on.
7. If steam accumulates inside or around the outside of the oven door, wipe with a soft cloth. This may occur when the microwave oven is operated under high humidity conditions, this is normal.
8. It is occasionally necessary to remove the glass tray for cleaning. Wash the tray in warm sudsy water or in a dishwasher.
9. The roller ring and oven floor should be cleaned regularly to avoid excessive noise. Simply wipe the bottom surface of the oven with mild detergent. The roller ring may be washed in mild sudsy water or dishwasher. When removing the roller ring from cavity floor for cleaning, be sure to replace in the proper position.
10. Remove odors from your oven by combining a cup of water with the juice and skin of one lemon in a deep bowl, microwave for 5 minutes. Wipe thoroughly and dry with a soft cloth.
11. When it becomes necessary to replace the oven light, please consult a dealer to have it replaced.

Save These Instructions

WARRANTY

This product carries a warranty that it will be free from defects in material and workmanship for a period of one year from the date of purchase.

NOTE: This warranty does not cover damages resulting from accident, misuse or abuse, lack of reasonable care, the affixing of any attachment not provided with the product, loss of parts, or subjecting the appliance to any but the specified voltage. If malfunction occurs, do not use the unit. Simply return the unit to the store at which it was purchased.

Sears will replace your unit at no charge to you.

The above warranty applies only to microwave ovens which are used for private household purpose.

SOLD BY SEARS CANADA INC.
TORONTO, ONTARIO M5B 2B8

SAVE THIS FOR YOUR RECORDS

Free Manuals Download Website

<http://myh66.com>

<http://usermanuals.us>

<http://www.somanuals.com>

<http://www.4manuals.cc>

<http://www.manual-lib.com>

<http://www.404manual.com>

<http://www.luxmanual.com>

<http://aubethermostatmanual.com>

Golf course search by state

<http://golfingnear.com>

Email search by domain

<http://emailbydomain.com>

Auto manuals search

<http://auto.somanuals.com>

TV manuals search

<http://tv.somanuals.com>