



# ELECTRIC BUILT-IN OVEN

Use & Care Guide

# HORNO DE PARED

Manual del Usuario

Models, Modelos 790.4717\*, 4778\*, 4783\*

\* = Color number, número de color

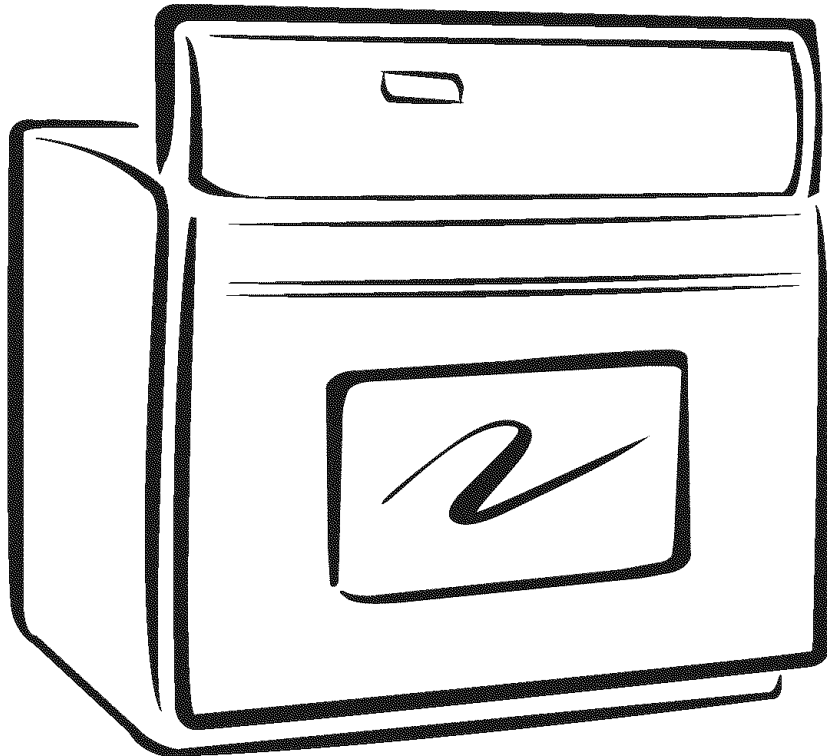

ENGLISH

ESPAÑOL

# Table of Contents

Wall Oven Warranty ..... 2  
Product Record ..... 2  
Serial Plate Location ..... 2  
**IMPORTANT SAFETY INSTRUCTIONS** ..... 3-4  
Protection Agreements ..... 5  
Wall Oven Features ..... 6  
Oven Vent and Racks ..... 7  
Air Circulation in the Oven ..... 7

Control Pad Features ..... 8  
Setting the Clock ..... 9  
Setting the Oven Controls ..... 10-15  
Self-Cleaning (some models) ..... 17-18  
General Care & Cleaning ..... 19-23  
Adjusting the Oven Temperature ..... 22  
Before You Call ..... 23-24  
Notes ..... 25  
Sears Service ..... 26  
Español ..... 27

## Please carefully read and save these instructions

This Use & Care Manual contains general operating instructions for your appliance and feature information for several models. Your product **may not** have all the described features. The graphics shown are representative. The graphics on your appliance may not look exactly like those shown. Common sense and caution must be practiced when installing, operating and maintaining any appliance.

### Kenmore Warranty

When installed, operated and maintained according to all instructions supplied with the product, if this appliance fails due to a defect in material and workmanship within one year from the date of purchase, call 1-800-4-MY-HOME® to arrange for free repair.

This warranty applies for only 90 days from the date of purchase if this appliance is ever used for other than private family purposes.

#### **This warranty covers only defects in material and workmanship. Sears will NOT pay for:**

1. Cracks in a ceramic glass cooktop that are not a result of thermal shock.
2. Stains and scratches on a ceramic glass cooktop resulting from accident or improper operation or maintenance.
3. Expendable items that can wear out from normal use, including but not limited to filters, belts, light bulbs, and bags.
4. A service technician to instruct the user in correct product installation, operation or maintenance.
5. A service technician to clean or maintain this product.
6. Damage to or failure of this product if it is not installed, operated or maintained according to the all instructions supplied with the product.
7. Damage to or failure of this product resulting from accident, abuse, misuse or use for other than its intended purpose.
8. Damage to or failure of this product caused by the use of detergents, cleaners, chemicals or utensils other than those recommended in all instructions supplied with the product.
9. Damage to or failure of parts or systems resulting from unauthorized modifications made to this product.

#### **Disclaimer of implied warranties; limitation of remedies**

Customer's sole and exclusive remedy under this limited warranty shall be product repair as provided herein. Implied warranties, including warranties of merchantability or fitness for a particular purpose, are limited to one year or the shortest period allowed by law. Sears shall not be liable for incidental or consequential damages. Some states and provinces do not allow the exclusion or limitation of incidental or consequential damages, or limitation on the duration of implied warranties of merchantability or fitness, so these exclusions or limitations may not apply to you.

This warranty applies only while this appliance is used in the United States or Canada.

This warranty gives you specific legal rights, and you may also have other rights which vary from state to state.

**Sears, Roebuck and Co., Hoffman Estates, IL 60179**  
**Sears Canada Inc., Toronto, Ontario, Canada M5B 2B8**

## Product Record

In this space below, record the date of purchase, model and serial number of your product. You will find the model and serial number printed on the serial plate.

Model No. 790.

Serial No. \_\_\_\_\_

Date of purchase \_\_\_\_\_

Save these instructions and your sales receipt for future reference.

## Serial Plate Location

You will find the model and serial number printed on the serial plate. The serial plate is located along the interior side trim and visible when the oven door is opened.

Remember to record the serial number for future reference.

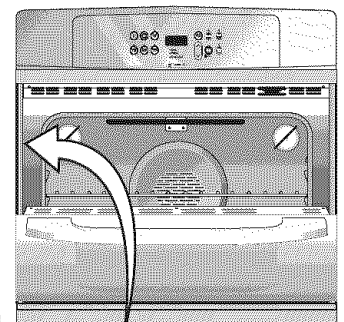

**Serial Plate Location**

# Important Safety Instructions

Read all instructions before using this appliance.

Save these instructions for future reference.

This manual contains important safety symbols and instructions. Please pay attention to these symbols and follow all instructions given.

**⚠ WARNING** This symbol will help alert you to situations that may cause serious bodily harm, death or property damage.

**⚠ CAUTION** This symbol will help alert you to situations that may cause bodily injury or property damage.

- **Remove all tape and packaging before using the appliance.** Destroy the carton and plastic bags after unpacking the appliance. Never allow children to play with packaging material.
- **Proper Installation.** Be sure your appliance is properly installed and grounded by a qualified technician in accordance with National Electrical Code ANSI/NFPA No.70 (USA) or CSA C22.1, PART 1 (Canada)-latest edition and local code requirements. Install only per installation instructions provided in the literature package for this appliance.

Sears Parts & Repair is the recommended repair service for this appliance. Know how to disconnect the electrical power to the appliance at the circuit breaker or fuse box in case of an emergency.

**⚠ CAUTION** Electronic controllers can be damaged by cold temperatures. When you use your appliance for the first time, or if it has not been used for a long period of time, make sure that it has been exposed to a temperature above 0°C/32°F for at least 3 hours before connecting it to the power supply.

- **User Servicing.** Do not repair or replace any part of the appliance unless specifically recommended in the manuals. All other servicing should be done only by a qualified technician to reduce the risk of personal injury and damage to the appliance.
- **Never modify or alter the construction of an appliance by removing panels, wire covers or any other part of the product.**



**⚠ WARNING**

- All wall ovens can tip.
- Injury to persons could result.
- Install anti-tip bracket packed with wall oven.
- See Installation Instructions.



To reduce the risk of tipping, the wall oven must be secured by properly installed anti-tip bracket provided with the wall oven. Refer to the Installation Instructions for proper anti-tip bracket installation.

- **Remove the oven door from any unused appliance if it is to be stored or discarded.**

**⚠ WARNING** Stepping, leaning, sitting or pulling down on the door of this appliance can result in serious injuries and may also cause damage to the appliance. Do not allow children to climb or play around the appliance.

- **Storage on Appliance.** Flammable materials should not be stored near surface units. This includes paper, plastic and cloth items, such as cookbooks, plasticware and towels, as well as flammable liquids. Do not store explosives, such as aerosol cans, on or near the appliance. Flammable materials may explode and result in fire or property damage.

**⚠ WARNING** Do not use the oven for storage.

**⚠ CAUTION** Do not store items of interest to children in the cabinets above an appliance. Children climbing on the appliance to reach items could be seriously injured.

- **Do not leave children alone.** Children should not be left alone or unattended in the area where an appliance is in use. They should never be allowed to sit or stand on any part of the appliance.

- **DO NOT TOUCH SURFACE UNITS OR AREAS NEAR THESE SURFACES.** Surface units may be hot even though they are dark in color. Areas near surface units may become hot enough to cause burns. During and after use, do not touch, or let clothing or other flammable materials touch these areas until they have had sufficient time to cool. Among these areas are the cooktop and areas facing the cooktop.

- **Wear Proper Apparel.** Loose-fitting or hanging garments should never be worn while using the appliance. Do not let clothing or other flammable materials contact hot surfaces.

**⚠ WARNING** Never use your appliance for warming or heating the room.

# Important Safety Instructions

- **Do Not Use Water or Flour on Grease Fires. Smother the fire with a pan lid, or use baking soda, a dry chemical or foam-type extinguisher.**
- **When heating fat or grease, watch it closely.** Fat or grease may catch fire if allowed to become too hot.
- **Use Only Dry Potholders. Moist or damp potholders on hot surfaces may result in burns from steam.** Do not let the potholders touch hot heating surface units. Do not use a towel or other bulky cloth instead of a potholder.
- **Do Not Heat Unopened Food Containers. Buildup of pressure may cause the container to burst and result in injury.**
- **Do not touch a hot oven light bulb with a damp cloth.** Doing so could cause the bulb to break. Disconnect the appliance or shut off the power to the appliance before removing and replacing the bulb.
- **Protective liners**—Do not use aluminum foil to line the oven bottom. Only use aluminum foil as recommended in this manual. Improper installation of these liners may result in risk of electric shock, or fire.

## IMPORTANT INSTRUCTIONS FOR CLEANING YOUR OVEN

**IMPORTANT**—Do not attempt to operate the appliance during a power failure. If power fails, always turn off the appliance. If the appliance is not turned off and the power resumes, it will begin to operate again. Once the power resumes, reset the clock and oven function.

## IMPORTANT INSTRUCTIONS FOR USING YOUR OVEN

- **Use Care When Opening an Oven Door**—Stand to the side of the appliance when opening the door of a hot oven. Let hot air or steam escape before you remove or replace food in the oven.
- **Keep Oven Vent Ducts Unobstructed.** The wall oven is vented at the upper control panel or at the center trim depending of the model. Touching the surfaces in this area when the wall oven is operating may cause severe burns. Also, do not place plastic or heat-sensitive items near the oven vent. These items could melt or ignite.
- **Placement of Oven Racks.** Always place oven racks in desired location while oven is cool. Remove all utensils from the rack before removing rack. If rack must be moved while oven is hot, use extreme caution. Use pot holders and grasp the rack with both hands to reposition. Do not let pot holders contact the hot oven element or interior of the oven.
- **Do not use your broiler pan without its insert.** Broiler pan and grid allow dripping fat to drain and be kept away from the high heat of the broiler.
- **Do not cover the broiler grid or oven bottom with aluminum foil.** Exposed fat and grease could ignite.

- **Clean the appliance regularly to keep all parts free of grease that could catch fire.** Exhaust fan ventilation hoods and grease filters should be kept clean. Do not allow grease to accumulate. Greasy deposits in the fan could catch fire. Refer to the hood manufacturer's instructions for cleaning.
- **Cleaners/Aerosols**—Always follow the manufacturer's recommended directions for use. Be aware that excess residue from cleaners and aerosols may ignite causing damage and/or injury.

## SELF-CLEANING OVEN MODELS

- **Clean in the self-cleaning cycle only the parts of the appliance listed in this Owner's Guide.** Before using the self-cleaning cycle of the appliance, remove all utensils stored in the appliance.
- **Do not clean the oven door gasket.** The door gasket is essential for a good seal. Care should be taken not to rub, damage or move the gasket.
- **Do not use oven cleaners.** No oven cleaner or oven liner protective coating of any kind should be used in or around any part of the appliance

**CAUTION** The health of some birds is extremely sensitive to the fumes given off during the self-clean cycle of any wall oven. Move birds to another well ventilated room.

---

## IMPORTANT SAFETY NOTICE

The California Safe Drinking Water and Toxic Enforcement Act requires the Governor of California to publish a list of substances known to the state to cause cancer, birth defects or other productive harm, and requires businesses to warn customers of potential exposure to such substances.

---

# PROTECTION AGREEMENTS

## Master Protection Agreements

*Congratulations on making a smart purchase. Your new Kenmore® product is designed and manufactured for years of dependable operation. But like all products, it may require preventive maintenance or repair from time to time. That's when having a Master Protection Agreement can save you money and aggravation.*

The Master Protection Agreement also helps extend the life of your new product. Here's what the Agreement\* includes:

- ☑ **Parts and labor** needed to help keep products operating properly **under normal use**, not just defects. Our coverage goes **well beyond the product warranty**. No deductibles, no functional failure excluded from coverage – **real protection**.
- ☑ **Expert service** by a force of more than **10,000 authorized Sears service technicians**, which means someone you can trust will be working on your product.
- ☑ **Unlimited service calls and nationwide service**, as often as you want us, whenever you want us.
- ☑ **«No-lemon» guarantee** – replacement of your covered product if four or more product failures occur within twelve months.
- ☑ **Product replacement** if your covered product can't be fixed.
- ☑ **Annual Preventive Maintenance Check** at your request – no extra charge.
- ☑ **Fast help by phone** – we call it **Rapid Resolution** – phone support from a Sears representative on all products. Think of us as a «talking owner's manual».
- ☑ **Power surge protection** against electrical damage due to power fluctuations.
- ☑ **\$250 Food Loss Protection** annually for any food spoilage that is the result of mechanical failure of any covered refrigerator or freezer.
- ☑ **Rental reimbursement** if repair of your covered product takes longer than promised.
- ☑ **10% discount** off the regular price of any non-covered repair service and related installed parts.

Once you purchase the Agreement, a simple phone call is all that it takes for you to schedule service. You can call anytime day or night, or schedule a service appointment online.

The Master Protection Agreement is a risk free purchase. If you cancel for any reason during the product warranty period, we will provide a full refund. Or, a prorated refund anytime after the product warranty period expires. Purchase your Master Protection Agreement today!

**Some limitations and exclusions apply. For prices and additional information in the U.S.A. call 1-800-827-6655.**

**\* Coverage in Canada varies on some items. For full details call Sears Canada at 1-800-361-6665.**

## Sears Installation Service

*For Sears professional installation of home appliances, garage door openers, water heaters, and other major home items, in the U.S.A. or Canada call **1-800-4-MY-HOME**®.*

## Acuerdos maestros de protección

*Enhorabuena por haber hecho una compra inteligente. Su nuevo producto Kenmore® está diseñado y fabricado para brindarle años de funcionamiento fiable. Pero, como cualquier producto, puede necesitar mantenimiento preventivo o reparaciones periódicas. Es por eso que tener un Acuerdo maestro de protección podría ahorrarle dinero y molestias.*

El Acuerdo maestro de protección también sirve para prolongar la durabilidad de su nuevo producto. El acuerdo\* incluye lo siguiente:

- ☑ **Piezas y mano de obra** necesarias para contribuir a mantener el funcionamiento adecuado de los productos **utilizados en condiciones normales de uso**, no sólo en caso de defectos de los productos. Nuestra cobertura va **mucho más allá que la garantía del producto**. No se aplican deducibles ni exclusiones por fallas del funcionamiento: es decir, **verdadera protección**.
- ☑ **Servicio técnico por expertos** (más de **10000 técnicos autorizados de Sears**), lo cual significa que quien repare o realice el mantenimiento de su producto será un profesional de confianza.
- ☑ **Servicio técnico a escala nacional y número ilimitado de llamadas de solicitud de servicio técnico**: se puede poner en contacto con nosotros cuantas veces lo desee y cuando lo desee.
- ☑ **Garantía «sin sorpresas»**: se reemplaza el producto cubierto por el acuerdo si ocurren cuatro o más fallas del producto en un periodo de 12 meses.
- ☑ **Reemplazo del producto**: en caso de que no se pueda reparar el producto cubierto por el acuerdo.
- ☑ **Revisión anual preventiva de mantenimiento del producto**: puede solicitarla en cualquier momento, sin costo alguno.
- ☑ **Rápida asistencia telefónica**, la cual denominamos **Solución rápida**: es decir, asistencia telefónica a través de cualquiera de nuestros representantes de Sears, sobre cualquiera de nuestros productos. Piense en nosotros como en un «manual parlante del usuario».
- ☑ **Protección contra fallas eléctricas**, contra daños debidos a fluctuaciones de la corriente eléctrica.
- ☑ **\$250 al año para cubrir cualquier posible deterioro de alimentos** que haya tenido que desechar debido a una falla mecánica de cualquiera de nuestros refrigeradores o congeladores cubiertos por este acuerdo.
- ☑ **Devolución de gastos de alquiler de electrodomésticos** si la reparación de su producto asegurado toma más que el tiempo prometido.
- ☑ **10% de descuento** aplicable tanto a los costos del servicio de reparación, como de las piezas instaladas relacionadas que no hayan quedado cubiertos por este acuerdo.

Una vez que haya realizado el pago de este acuerdo, bastará una simple llamada telefónica para concertar una visita de servicio. Puede llamar a cualquier hora del día o de la noche, o bien concertar una visita de servicio por Internet.

La adquisición del Acuerdo maestro de protección es una inversión exenta de riesgos. Si por cualquier motivo decide cancelar dicho acuerdo durante el periodo de garantía del producto, le haremos un reintegro total del valor. O bien un importe proporcional si cancela el acuerdo en cualquier otro momento posterior al vencimiento del periodo de garantía del producto. ¡Adquiera hoy mismo su Acuerdo maestro de protección!

**Algunas limitaciones y exclusiones podrían aplicarse. Para solicitar precios e información adicional, llame al 1-800-827-6655 (en los EE.UU.).**

**\* La cobertura en Canadá varía en el caso de algunos artículos. Para obtener detalles completos al respecto, llame al 1-800-361-6665 de Sears de Canadá.**

## Servicio de instalación de Sears

*Para solicitar la instalación por profesionales de Sears de electrodomésticos, abridores de puertas de garaje, calentadores de agua y otros artículos de uso prioritario en el hogar, llame al **1-800-4-MY-HOME** en los EE.UU. o Canadá.*

# Wall Oven Features

Note: The features of your wall oven will vary according to model.

## Your Electric Wall Oven Features At a Glance

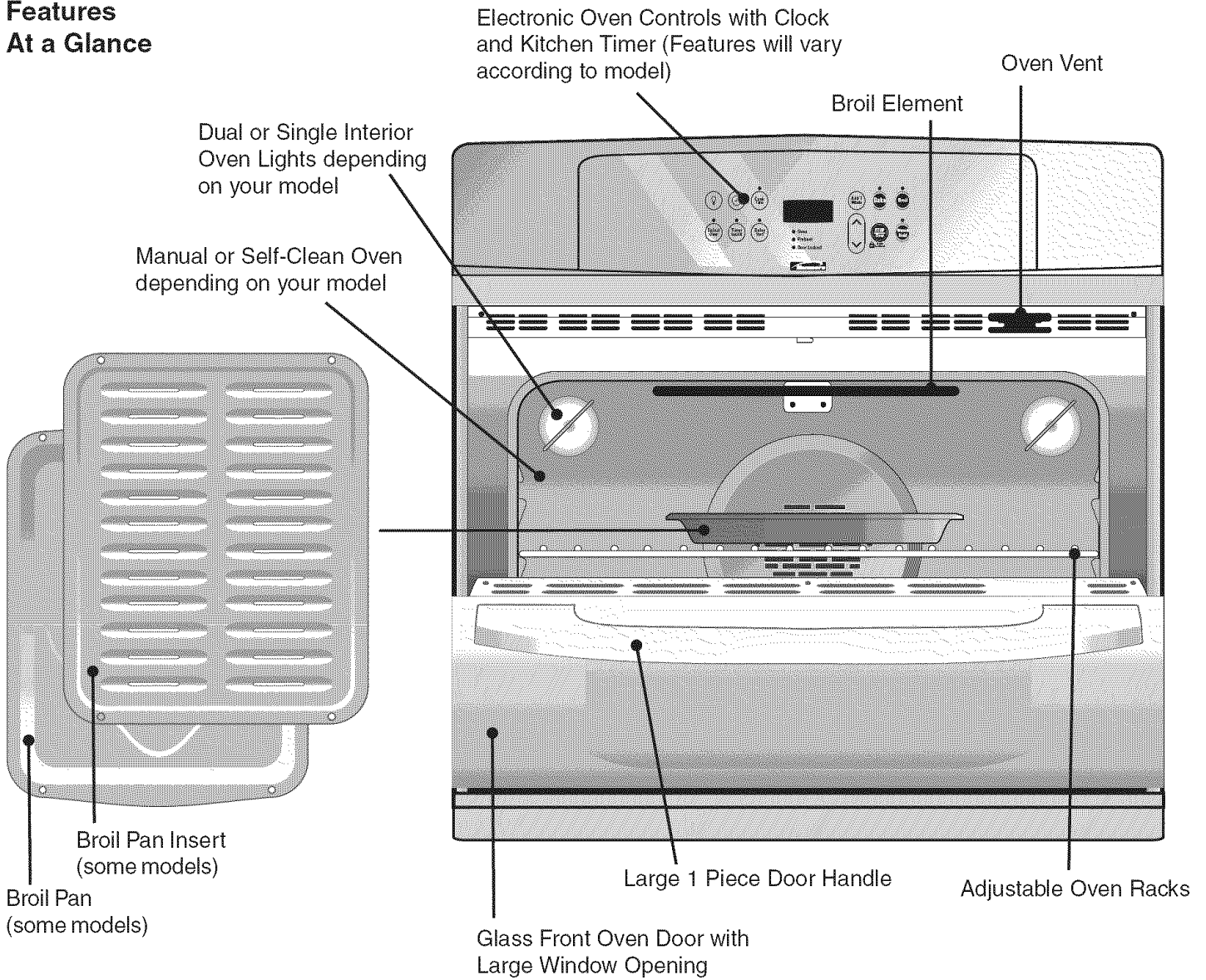

# Oven Vent and Racks

Oven Vent Location

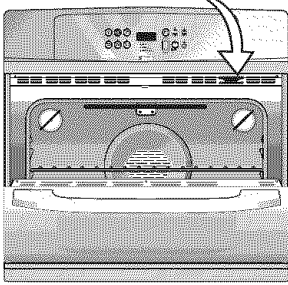

**CAUTION** Some models are equipped with a blower which runs in baking and self-cleaning mode to keep all internal components at a cool temperature. The blower may keep running even if the oven has been turned off, until the components have cooled down.

## Oven Vent Location

The oven is vented **at the center trim**. When the oven is on, warm air is released through the vent. This venting is necessary for proper air circulation in the oven and good baking results.

## Arranging Oven Racks

*ALWAYS ARRANGE OVEN RACKS WHEN THE OVEN IS COOL (PRIOR TO OPERATING THE OVEN).* Always use oven mitts when using the oven.

**To remove an oven rack**, pull the rack forward until it stops. Lift up front of rack and slide out.

**To replace an oven rack**, fit the rack onto the guides on the oven walls. Tilt the front of the rack upward and slide the rack back into place.

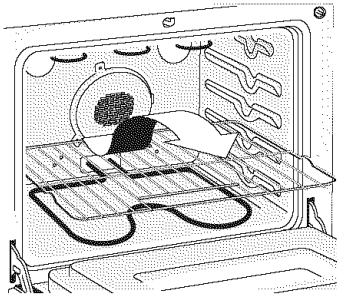

## Air Circulation in the Oven

If using 1 rack, place in center of oven. If using multiple racks, stagger cookware as shown.

For best air circulation and baking results allow 2-4" (5-10 cm) around the cookware for proper air circulation and be sure pans and cookware do not touch each other, the oven door, sides or back of the oven cavity. The hot air must circulate around the pans and cookware in the oven for even heat to reach around the food.

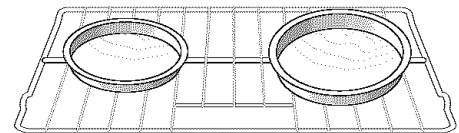

1 Oven Rack

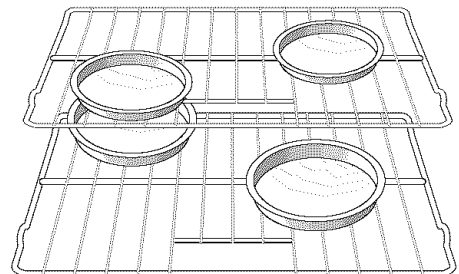

Multiple Oven Racks

ENGLISH

## Control Pad Features

**Note:** The appearance of your oven control may differ slightly from the one illustrated below. However, all functions are the same. Also, push buttons or pads may be shaped differently than those appearing in this Use and Care Guide.

**READ THE INSTRUCTIONS CAREFULLY BEFORE USING THE OVEN.** For satisfactory use of your oven, become familiar with the various functions of the oven as described below.

**OVEN INTERIOR LIGHT PAD** Used to turn oven interior light ON and OFF.

**CLOCK SET PAD** Used to set the time of day.

**COOK TIME PAD** Used to enter the length of the baking time.

**UP and DOWN ARROWS PADS** Used along with the function pads to select oven temperature, cook time, start time (when programming an automatic start time), time of day, clean time and minute timer.

**ADD 1 MINUTE PAD** Used to add 1 minute to the Timer Count-down. This feature works with the Kitchen Timer only and does not affect any cook time or start time functions. (some models).

**BAKE PAD**— Used to select the bake function.

**FEATURE INDICATOR LIGHTS**— These light to show which feature is in use.

**BROIL PAD**— Used to select the variable broil function.

**WARM & HOLD PAD**— Used to set the Warm & Hold feature.

**TIMER SET/OFF PAD** Used to set or cancel the minute timer. The minute timer does not start or stop cooking. Also, TIMER SET/OFF Pad is used to set the Continuous Bake Feature.

**SELECT SELF-CLEAN PAD** Used to select the Self-Cleaning cycle. A 2, 3 or 4 hour Self-Clean time may be selected (some models).

**DELAY START PAD** Used to set the desired start time for baking. May be used with COOK TIME to program a delayed bake cycle or a delayed clean cycle.

**OVEN, PREHEAT & DOOR LOCK LIGHTS\*** The "Oven" light will glow each time the oven unit turns on to maintain the set oven temperature. The "Preheat" light will glow when the oven is first set to operate, or if the desired temperature is reset higher than the actual oven temperature. The "Door Locked" light will flash until the door locks when the self-clean cycle is in use. It glows constantly after the door locks (some models).

**STOP CLEAR PAD**— Used to clear any function previously entered except the time of day and minute timer. Press STOP CLEAR to stop cooking. Also the STOP CLEAR pad is used to activate oven lockout setting. (some models).

**Buttons shown in diagram:** Select Clean, Timer Set/Off, Delay Start, Add 1 Minute, Bake, Broil, Warm & Hold, STOP Clear, Oven Lockout.



**Indicators shown in diagram:** Oven, Preheat, Door Locked.

**Kenmore logo**

**\*Note:** The **OVEN** indicator light on the electronic display will turn ON and OFF when using the Bake feature and during preheat. This is normal and indicates that the oven is cycling to maintain the selected baking temperature. When preheat indicator light turns OFF, your oven is ready.

### For a silent control panel:

When choosing a function, a beep will be heard each time a pad is pressed. If desired, the control can be programmed for silent operation.





- To tell if your oven is set for normal or silent operation press and hold  for 7 seconds. "- -" or "SP" appears in the display.
- Within 5 seconds, press the  or  pad to switch between normal sound operation and silent operation mode. The display will show either "- -" or "SP".
- Wait 5 seconds to return to normal operating mode.

If "SP" appears, the control will operate with normal sounds and beeps. If "- -" appears, the control is in the silent operation mode.

### Temperature Conversion (Fahrenheit / Celsius)

The electronic oven control is set to operate in °F (Fahrenheit) when shipped from the factory. The oven can be programmed for any temperature from 170°F to 550°F (77°C to 288°C).

**To change the temperature to °C (Celsius) or from °C to °F (control should not be in a Bake or Clean mode):**

- Press and hold  for 7 seconds until °F or °C appears in the display.
- Press the  or  pad to change °F to °C or °C to °F.
- Wait 5 seconds to accept the changes or press  to reject the changes.







# Setting the Clock

**Note:** The time of day **must** first be set in order to operate the oven.

## To Set the Clock





When the range is first plugged in, or when the power supply to the appliance has been interrupted, the display will flash "12:00".

1. Press  once (do not hold pad down).
2. Within 5 seconds, press and hold the  or  until the correct time of day appears in the display.
3. Press  once to accept the new time of day. If  is not pressed, the timer will return automatically to the new time of day after 7 seconds.

**Note:** The clock cannot be changed during any timed bake, delayed time bake, self-clean cycle or delayed self-clean cycle.

---





## Changing Between 12 or 24 Hour Time of Day Display

1. Press and hold  for 7 seconds. After 7 seconds, "12Hr" or "24Hr" will appear in the display and the control will beep once.
2. Press  or  to switch between the 12 and 24 hour time of day display. The display will show either "12Hr" or "24Hr".
3. Wait 5 seconds or press  to return to the time of day display.
4. Reset the correct time as described in **To set the Clock** above. Please note that if the 24 hour time of day mode was chosen, the clock will now display time from 0:00 through 23:59 hours.

ENGLISH

---

## To Set the Minute Timer

1. Press .
2. Press the  to increase or  to decrease the time in one minute increments. The timer can be set for any amount of time from 1 minute to 11 hours and 59 minutes.
3. The display shows the timer countdown in minutes if more than 1 hour remains. When less than 1 hour remains, the display will count down in seconds.
4. When the set time has run out, the timer will beep 3 times. It will continue to beep 3 times every 8 seconds until  is pressed.



**Note:** The indicator light located above the  pad will glow while the minute timer is active.

**Note:** The minute timer does not start or stop cooking. It serves as an extra timer in the kitchen that will beep when the set time has run out. The minute timer can be used alone or during any of the other oven functions. When the minute timer is in use with any other mode, the minute timer will be shown in the display. To view other functions, press the function pad for that mode.

**To Cancel the Minute Timer before the set time has run out:** Press .

---

## To Set Add 1 Minute Feature

The  ADD 1 MINUTE pad is used to set the Add 1 Minute feature. When the  pad is pressed, 1 minute is added to the Minute Timer feature if this feature is already active. If the Minute Timer feature is not active and the  pad is pressed, the Minute Timer feature will become active and will begin counting down from 1 minute. For further information on how to set the Minute Timer feature see To Set the Minute Timer instructions above.

## Setting Oven Controls

**Note:** The time of day **must** first be set in order to operate the oven.

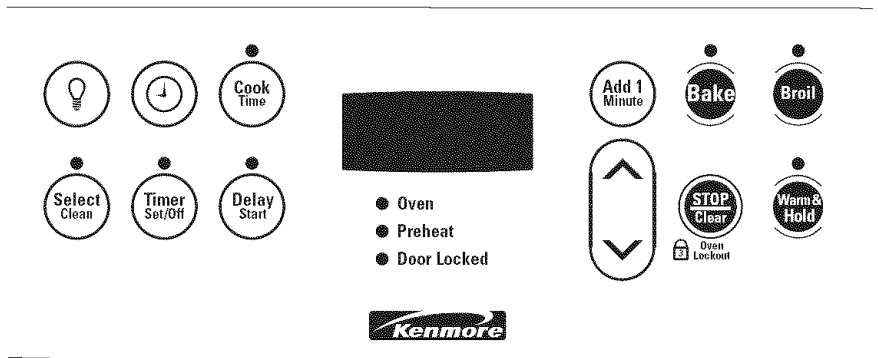

### To Set or Change the Temperature for Baking

The oven can be programmed to bake at any temperature from 170°F to 550°F (77°C to 288°C).

#### To Set the Controls for Normal Baking:

1. Press **Bake**. "— — —°" appears in the display.
2. Within 5 seconds, press the **▲** or **▼**. The display will show "350°F (177°C)." By pressing and holding **▲** or **▼**, the temperature can then be adjusted in 5°F increments (1°C if the control is set to display Celsius).
3. 10 seconds after the **▲** or **▼** pad is released, the oven will begin heating to the selected temperature. When the displayed temperature reaches the desired baking temperature, the preheat indicator light will turn OFF.
4. To cancel the baking function, press **STOP Clear**.

#### To Change the Oven Temperature after Baking has Started:

Press the **▲** or **▼** pad to increase or decrease the set temperature.

### To Set Control for Continuous Bake or 12 Hour Energy Saving:

The oven control has a built-in 12 Hour Energy Saving feature that will shut off the oven if the control is left on for more than 11 hours and 59 minutes. The oven can be programmed to override this feature for continuous baking.

#### To set control for continuous baking:

1. Press and hold **Timer Set/Off** down for 7 seconds until tone is heard.
2. Within 5 seconds, press the **▲** or **▼** pad to switch between Continuous Bake and 12 Hour Energy Saving mode. The display will show either "- - hr" or "12hr".  
If "- - hr" appears, the oven will be set to continuous baking. If "12hr" appears, the oven is set to 12 hour energy saving mode.
3. Wait 5 seconds or press **STOP Clear** to return to normal operating mode.

### To Set Control for Oven Lockout (some models):



The control can be programmed to lock the oven door (some models) and/or lock the oven control pads (all models).

#### To Set Control for Oven Lockout feature:

1. Press **STOP Clear** and hold for 3 seconds. The "Door Locked" indicator light will glow and the motor driven door lock will begin to close automatically. **DO NOT open oven door** while the indicator light is flashing. Allow about 15 seconds for the oven door to lock. Once the oven door is locked, "Loc" will appear in display.
2. To cancel the Oven Lockout feature, press **STOP Clear** and hold for 3 seconds. The control will unlock the oven door and resume normal operation.









# Setting Oven Controls

## To Set the Timed Bake and Delay Start Features



The  **COOK TIME** and  **DELAY START** pads operate the features that will turn the oven ON and OFF at the times you select in advance. The oven can be programmed to start immediately and shut off automatically (Timed Bake) or to begin baking at a later time with a delayed start time (Delay Start).

**Note:** During Timed Bake the preheat indicator light will glow during the preheat operation.











### To Program the Oven to Begin Baking Immediately and To Shut Off Automatically (Timed Bake):

1. Be sure that the clock shows the correct time of day.
2. Place the food in the oven.
3. Press . "— — —°" appears in the display.
4. Within 5 seconds, press the  or . The display will show "350°F (177°C)." By holding the  or , the temperature can then be adjusted in 5°F increments (1° if the control is set to display Celsius).
5. Wait 8 seconds to accept the temperature.
6. Press . "0:00" will flash in the display (MIN:SEC) and (HR:MIN) if programmed for more than 60 minutes.
7. Press the  or  pad until the desired baking time appears in the display.
8. The oven will turn ON and begin heating.



**Note:** When the control is set for this function the oven temperature will be displayed. To see the cook time remaining

press  and to see the time of day press 

### To Program Oven for a Delayed Start Time and to Shut-Off Automatically (Delayed Start Bake):

1. Be sure that the clock shows the correct time of day.
2. Place the food in the oven.
3. Press . "— — —°" appears in the display.
4. Within 5 seconds, press the  or . The display will show "350°F (177°C)." By holding the  or , the temperature can then be adjusted in 5°F increments (1° if the control is set to display Celsius).
5. Wait 8 seconds to accept the temperature.
6. Press . "0:00" will flash in the display (MIN:SEC) and (HR:MIN) if programmed for more than 60 minutes.
7. Press the  or  until the desired baking time appears.
8. Wait 5 seconds for control to accept the time.
9. Press . The earliest possible start time will appear in the display.
10. Press the  or  until the desired start time appears in the display and wait 7 seconds to accept.
11. Once the controls are set, the control calculates the time when baking will start and stop.
12. The oven will turn ON at the delayed start time and begin heating.



**Note:** When the control is set for a delayed time bake the time of day is displayed until the delayed time bake is reached. When the oven will turn on, the oven temperature will be displayed. To see the cook time remaining

press  and to see the time of day press 

### When the Set Bake Time Runs Out:

1. "END" will appear in the display window and the oven will shut off automatically.
2. The control will beep 3 times every 25 seconds until  is pressed.

### To Change the Oven Temperature or Bake Time after Baking has Started:

1. Press the function pad you want to change.
2. Press the  or  to adjust the setting.



**CAUTION** Use caution with the Timed Bake and Delayed Start features. Foods that can easily spoil such as milk, eggs, fish, meat or poultry, should be chilled in the refrigerator first. Even when chilled, they should not stand in the oven for more than 1 hour before cooking begins, and should be removed promptly when cooking is completed.

# Setting Oven Controls

## Oven Baking

For best cooking results, heat the oven before baking cookies, breads, cakes, pies or pastries, etc... There is no need to preheat the oven for roasting meat or baking casseroles.

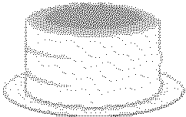
The cooking times and temperatures needed to bake a product may vary slightly from your previously owned appliance.

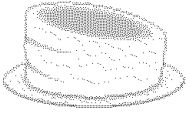
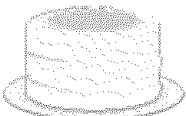
Baking Problems and Solutions Chart		
Baking Problems	Causes	Corrections
<p><b>Cookies and biscuits burn on the bottom.</b></p> 	<ul style="list-style-type: none"> <li>• Cookies and biscuits put into the oven before the preheating time is completed.</li> <li>• Oven rack overcrowded.</li> <li>• Dark pan absorbs heat too fast.</li> </ul>	<ul style="list-style-type: none"> <li>• Allow oven to preheat to the selected temperature before placing food in oven.</li> <li>• Choose pan sizes that will permit 5.1 cm to 10.2 cm (2" to 4") of air space on all sides when placed in the oven.</li> <li>• Use a medium-weight aluminum baking sheet.</li> </ul>
<p><b>Cakes too dark on top or bottom.</b></p> 	<ul style="list-style-type: none"> <li>• Cakes put into the oven before preheating time is completed.</li> <li>• Rack position too high or low.</li> <li>• Oven too hot.</li> </ul>	<ul style="list-style-type: none"> <li>• Allow oven to preheat to the selected temperature before placing food in the oven.</li> <li>• Use proper rack position for baking needs.</li> <li>• Set oven temperature 25°F/12°C lower than recommended.</li> </ul>
<p><b>Cakes not done in the center.</b></p> 	<ul style="list-style-type: none"> <li>• Oven too hot.</li> <li>• Incorrect pan size.</li> <li>• Pan not centered in oven.</li> </ul>	<ul style="list-style-type: none"> <li>• Set oven temperature 25°F/12°C lower than recommended.</li> <li>• Use pan size suggested in recipe.</li> <li>• Use proper rack position and place pan so there is 5.1 cm to 10.2 cm (2" to 4") of space on all sides of pan.</li> </ul>
<p><b>Cakes not level.</b></p> 	<ul style="list-style-type: none"> <li>• Range not level.</li> <li>• Pan too close to oven wall or rack overcrowded.</li> <li>• Pan warped.</li> </ul>	<ul style="list-style-type: none"> <li>• Place a marked glass measuring cup filled with water on the center of the oven rack. If the water level is uneven, refer to the installation instructions for leveling the range.</li> <li>• Be sure to allow 5.1 cm to 10.2 cm (2" to 4") of clearance on all sides of each pan in the oven.</li> <li>• Do not use pans that are dented or warped.</li> </ul>
<p><b>Foods not done when cooking time is up.</b></p> 	<ul style="list-style-type: none"> <li>• Oven too cool.</li> <li>• Oven overcrowded.</li> <li>• Oven door opened too frequently.</li> </ul>	<ul style="list-style-type: none"> <li>• Set oven temperature 25°F/12°C higher than suggested and bake for the recommended time.</li> <li>• Be sure to remove all pans from the oven except the ones to be used for baking.</li> <li>• Open oven door only after shortest recommended baking time.</li> </ul>

# Setting Oven Controls

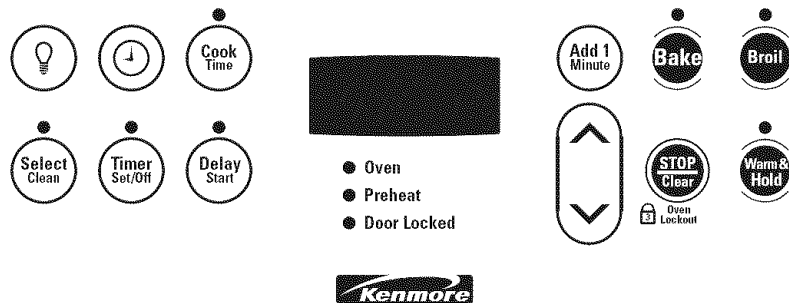

## Broil

Broiling is a method of cooking tender cuts of meat by direct heat under the broil element of the oven. Be sure you center the broiler pan directly under the broil element for best results.

Arrange oven rack while oven is still cool. Position the rack as needed. Broiler pan and its insert allow dripping grease to drain and be kept away from the high heat of the broiler. **DO NOT** use the pan without its insert. **DO NOT cover the insert with foil.** The exposed grease could ignite.

**⚠ WARNING** Should an oven fire occur, close the oven door and turn off the oven. If the fire continues, throw baking soda on the fire or use a fire extinguisher. **DO NOT** put water or flour on the fire. Flour may be explosive and water can cause a grease fire to spread and cause personal injury.

### To set for broiling:

1. Arrange oven rack while oven is still cool.
2. Press **Broil**. "- -" will appear in the display.
3. Press the **▲** or **▼** pad until the desired broil setting level appears in the display. Press the **▲** pad for **HI** broil or the **▼** pad for **LO** broil. Most foods may be broiled at the **HI** broil setting. Select the **LO** broil setting to avoid excess browning or drying of foods that should be cooked to the well-done stage.
4. Place the insert on broiler pan, then place the food on the insert. **DO NOT** use the pan without the insert or cover the insert with **aluminum foil**. The exposed grease could ignite.
5. Place the pan on the oven rack. **Open the oven door to the broil stop position when broiling.**
6. Broil on one side until food is browned. Turn and broil food on 2nd side. **Note:** Always pull the rack out to the stop position before turning or removing food.
7. When broiling is finished, press **STOP Clear**.

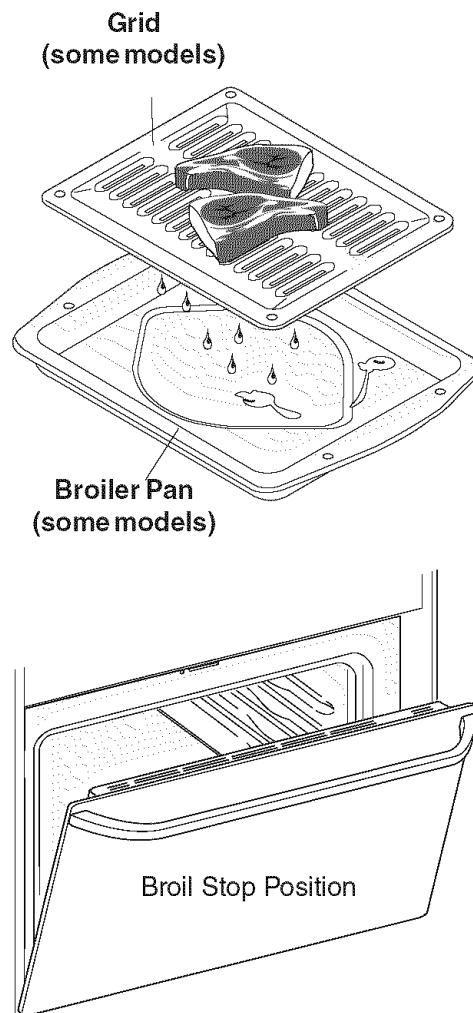

### To Operate the Oven Light(s)

The interior oven light(s) will automatically turn ON when the oven door is opened.

Press **Light Bulb** to turn the interior light(s) ON and OFF whenever the door is closed.

The interior oven light(s) is (are) located at the upper left (and right, some models) rear wall of the oven interior and is covered with a glass shield held by a wire holder. The glass shield must be in place whenever the oven is in use. To change the interior oven light(s), see changing the Oven Light in the **General Care & Cleaning** section.

# Setting Oven Controls

## Broiling information

Broiling is a method of cooking tender cuts of meat by direct heat under the broil element of the oven.

## Preheating

Preheating is suggested when searing rare steaks. (Remove all utensils from the oven before preheating. Foods will stick if placed on hot metal.) To preheat, set the control(s) to BROIL as instructed in the Owner's Guide. Wait for the element to become red-hot, usually about 2 minutes. Preheating is not necessary when broiling meats well-done.

## To Broil

Broil on side until the food is browned; turn and cook on the second side. Season and serve. Always pull rack out to the "stop" position before turning or removing food.

## Determine Broiling Times

Broiling times vary, so watch the food closely. Time not only depends on the distance from element, but on the thickness and aging of meat, fat content and doneness preferred. The first side usually requires a few minutes longer than second. Frozen meats also require additional time.

## Broiling Tips (some models)

Broiler pan and its grid allow dripping grease to drain and be kept away from the high heat of the broiler.

**DO NOT use the pan without its grid. DO NOT cover the grid with foil. The exposed grease could ignite.**

**CAUTION** Should an oven fire occur, close the oven door and turn off the oven. If the fire continues, throw baking soda on the fire or use fire extinguisher. DO NOT put water or flour on the fire. Flour may be explosive.

## Broiler Clean-Up Tips (some models):

To make cleaning easier, line the bottom of the broiler pan with aluminum foil. DO NOT cover the broiler grid with foil. To prevent grease from baking on, remove the broiler pan from the oven as soon as cooking is completed. Use hot pads because the broiler pan is extremely hot. Pour off grease. Soak the pan in HOT, soapy water. Clean the broiler pan as soon as possible after each use. If necessary, use soap-filled steel wool pads. Heavy scouring may scratch the grid.

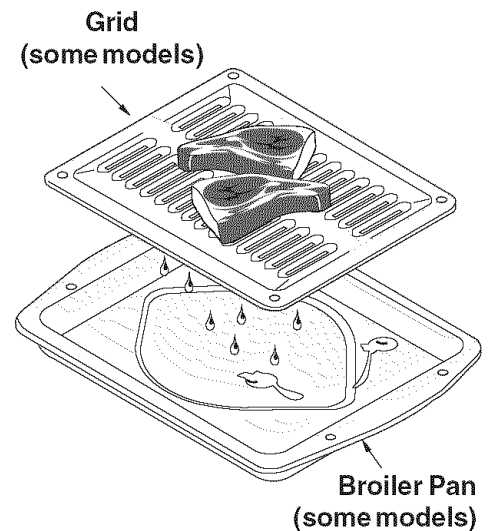
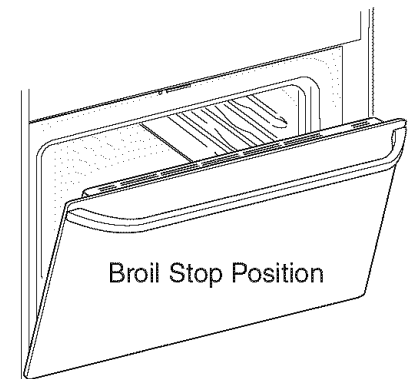





# Setting Oven Controls





## Setting the Warm & Hold™ Feature

The  pad turns ON the Serve Warm & Hold feature and will maintain an oven temperature of 170° F (77°C). The **Warm & Hold** feature will keep oven baked foods warm for serving up to 3 hours after cooking has finished. After 3 hours the Warm & Hold feature will shut the oven OFF automatically. The Warm & Hold feature may be used without any other cooking operations or can be used after cooking has finished using **TIMED BAKE** or **DELAY TIMED BAKE**.

### To set Warm & Hold:



1. Arrange interior oven racks and place baked food in oven. If the food is already in the oven go to step 2.
2. Press . "-" "-" will appear in the display and the Warm & Hold indicator light above the pad will turn ON.  
Note: If no further pads are touched within 6 seconds the request to turn ON Warm & Hold will be cleared.
3. Press  or  to start.
4. To turn Warm & Hold OFF at any time press . The Warm & Hold indicator light above the pad will turn OFF.

### To set Warm & Hold to turn ON automatically:



1. Arrange interior oven racks and place food in oven. Set the oven properly for **Timed Bake** or **Delay Timed Bake**.
2. Press . "-" "-" will appear in the display and the Warm & Hold indicator light above the pad will turn ON.
3. Press  or  to start. Warm & Hold is set to turn ON automatically after Timed Bake or Delayed Start Bake has finished.
4. To turn Warm & Hold OFF at any time press . The Warm & Hold indicator light above the pad will turn OFF.

# Setting Oven Controls

## To Set the Sabbath Feature (for use on the Jewish Sabbath & Holidays)













The  **COOK TIME** and  **DELAY START** pads are used to set the Sabbath feature. The Sabbath feature may only be used with the  pad. The oven temperature may be set higher or lower after setting the Sabbath feature (the oven temperature adjustment feature should be used only during Jewish Holidays), however the display will not visibly show or provide any audible tones indicating whether the change occurred correctly. Once the oven is properly set using Bake with the Sabbath feature active, the oven will remain continuously ON until cancelled. This will override the factory preset 12-Hour Energy Saving feature.

If the oven light will be needed during the Sabbath, press  before activating the Sabbath feature. Once the oven light is turned ON and the Sabbath feature is active, the oven light will remain ON until the Sabbath feature is turned OFF. If the oven light needs to be OFF, be sure to turn the oven light OFF before activating the Sabbath feature.



**IMPORTANT NOTES:** It is not advised to attempt to activate any other program feature other than **BAKE** while the Sabbath feature is active. ONLY the following key pads will function after setting the Sabbath feature; , ,  &

. **ALL OTHER KEYPADS** will not function once the Sabbath feature is properly activated.

### To Program the Oven to Begin Baking Immediately & activate the Sabbath feature:

1. Be sure that the clock is set with the correct time of day.
2. Place the food in the oven.
3. Press . " — — — ° " appears in the display.
4. Within 5 seconds, press the  or . The display will show "350°F (177°C)." By holding the  or , the temperature can then be adjusted in 5°F increments (1°C if the control is set to display Celsius).
5. If you desire to set the oven control for a **Timed Bake** or **Delayed Start Bake** do so at this time. If not, skip this step and continue to step 6. Refer to the **Timed Bake** (complete steps 6-7) / **Delayed Start Bake** (complete steps 6-10) section for complete instructions. Remember the oven will shut down after using **Timed Bake** or **Delay Start Bake** and therefore may only be used once during the Sabbath/Jewish Holidays. The maximum **Delayed Start Bake** time is 11 hours & 59 minutes.
6. The oven will turn ON and begin heating.
7. Press and hold both the  and  pads for at least 3 seconds. **SAb** will appear in the display. Once **SAb** appears in the display the oven control will no longer beep or display any further changes and the oven is properly set for the Sabbath feature.  
**Note:** You may change the oven temperature once baking has started by pressing the  or  (for Jewish Holidays only). The oven temperature will be adjusted in 5°F increments with each press of these pads (1°C if the control is set to display Celsius). Remember that **the oven control will no longer beep or display any further changes** once the oven is set for the Sabbath feature.
8. The oven may be turned OFF at any time by first pressing  pad (this will turn the oven OFF only). To turn OFF the Sabbath feature press and hold both the  and  pads for at least 3 seconds. **SAb** will disappear from the display.

Should you experience a power failure or interruption, the oven will shut off. When power is returned the oven will not turn back on automatically. The oven will remember that it is set for the Sabbath and the food may be safely removed from the oven while still in the Sabbath feature, however the oven cannot be turned back on until after the Sabbath. After

the Sabbath observance turn OFF the Sabbath feature. Press and hold both the  and  pads for at least 3 seconds. **SAb** will disappear from the display and the oven may be used with all normal functions. For further assistance, guidelines for proper usage, and a complete list of models with the Sabbath feature, please visit the web at <http://www.star-k.org>.



## Self-Cleaning (some models)

**CAUTION** During the self-cleaning cycle, the outside of the oven can become very hot to the touch. **DO NOT** leave small children unattended near the appliance.

**CAUTION** The health of some birds is extremely sensitive to the fumes given off during the self-clean cycle of any wall oven. Move birds to another well ventilated room.

**CAUTION** **DO NOT** line the oven walls, racks, bottom or any other part of the appliance with aluminum foil. Doing so will destroy heat distribution, produce poor baking results and cause permanent damage to the interior (aluminum foil will melt to the interior surface of the oven).

**CAUTION** **DO NOT** force the oven door open. This can damage the automatic door locking system. Use caution when opening the door after the Self-Cleaning cycle is completed. The oven may still be **VERY HOT**.



Note: See additional cleaning information for the oven door in the **General Care & Cleaning** section.

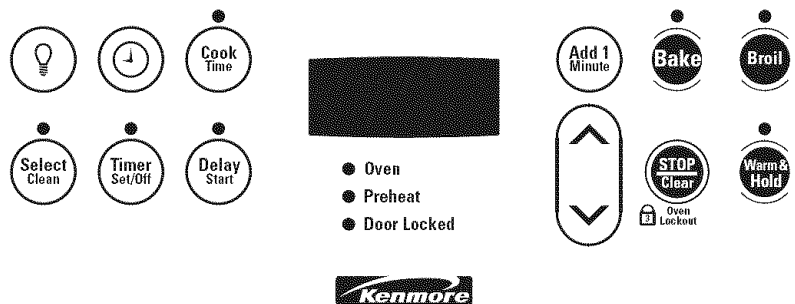

### Self-Cleaning Oven

A Self-Cleaning oven cleans itself with high temperatures (well above cooking temperatures) which eliminate soils completely or reduces them to a fine powdered ash you can wipe away with a damp cloth.

#### Adhere to the following cleaning precautions:

- Allow the oven to cool before cleaning.
- Wear rubber gloves when cleaning any exterior parts of the oven manually.
- **DO NOT** clean the oven door gasket. The woven material of the oven door gasket is essential for a good seal. Care should be taken not to rub, damage or remove the gasket.
- **DO NOT** use any cleaning materials on the oven door gasket. Doing so could cause damage.
- **Remove all utensils and any aluminum foil from the oven. These items cannot withstand high cleaning temperatures.**
- This oven comes with lubricated porcelain oven racks, which can remain in the oven during the self-clean cycle. Do not clean this vegetable oil lubrication off the racks. It is important that the sides of the oven racks always have a light coating of vegetable oil. To maintain optimal rack performance, re-apply a thin layer of vegetable oil to the sides of the rack after every self-clean cycle or when the rack becomes difficult to slide.
- **Remove any excessive spillovers** in the oven cavity **before** starting the Self-Cleaning cycle. To clean, use hot, soapy water and a cloth. Large spillovers can cause heavy smoke or fire when subjected to high temperatures. **DO NOT** allow food spills with a high sugar or acid content (such as milk, tomatoes, sauerkraut, fruit juices or pie filling) to remain on the surface as they may leave a dull spot even after cleaning.
- Clean any soil from the oven frame, the door liner outside the oven door gasket and the small area at the front center of the oven bottom. These areas heat sufficiently to burn soil on. Clean with soap and water.

**NOTE:** Prior to setting the Self-Clean cycle, any spills remaining on the oven bottom should be removed.

Some models have an exposed Bake element in the lower oven cavity. On these models the bake element is designed to be tilted up using your hand from the front of the bake element. This will allow easier access to the oven bottom for cleaning. Be careful not to raise the element more than 4 or 5 inches from the resting position.

**CAUTION** The oven bake and broil elements may appear to have cooled after they have been turned OFF. **The elements may still be hot** and burns may occur if these elements are touched before they have cooled sufficiently.

## Self-Cleaning (some models)

### What to Expect during Cleaning:

While the oven is in operation, the oven heats to temperatures much higher than those used in normal cooking. Sounds of metal expansion and contraction are normal. Odor is also normal as the food soil is being removed. Smoke may appear through the oven vent.







If heavy spillovers are not wiped up before cleaning, they may flame and cause more smoke and odor than usual. This is normal and safe and should not cause alarm. If available, use an exhaust fan during the self-cleaning cycle.

### Self-Clean Cycle time length

For satisfactory results, use a 2 hour Self-Clean cycle for **light soils** and a 3 hour cycle for **average** or a 4 hour cycle for **heavy soils**. **NOTE:** The kitchen area should be well ventilated using an open window, ventilation fan or exhaust hood during the Self-Clean cycle. This will help eliminate the normal odors associated with the Self-Clean cycle.

### To Set the Controls for a Self-Clean Cycle or a Delayed Start Self-Clean Cycle:

(Note: If you do not want to start a **Delayed** Self-Clean Cycle, skips steps 2 & 3.)

1. Be sure the clock shows the correct time of day.
2. Press .
3. Press and hold the  pad to scroll to the time to start the delayed Self-Clean cycle. Release the pad when the desired time is displayed.
4. Press . "- -" appears in the display.
5. Press the  or  once. "3:00" appears in the display for a 3 hour cycle. To change to a 2 hour cycle press . "2:00" appears in the display or to select a 4 hour cycle press . "4:00" appears in the display. As soon as the controls are set, the motor driven lock will begin to close automatically and the "Door Locked" indicator light will flash. **DO NOT** open the oven door while the light is flashing (it takes about 15 seconds for the oven door to lock).
6. "CLn" will appear in the display during the Self-Clean cycle and the "Door Locked" light will glow until the Self-Cleaning cycle is complete or cancelled and the oven temperature has cooled.

### When the Self-Clean Cycle is Completed:

1. The time of day or "End" will appear in the display window and the "Clean" and "Door Lock" light will continue to glow.
2. Once the oven has cooled down for about 1 HOUR and the "Door Lock" light has gone out, the oven door can be opened.
3. If "End" is in the display and the Select Clean indicator light remains ON, press . The time of day will appear in the display.

**NOTE:** When the oven is cool, wipe away any residue or powdered ash with a damp cloth or paper towel.

### Stopping or Interrupting a Self-Cleaning Cycle

If it becomes necessary to stop or interrupt a Self-Cleaning cycle:

1. Press .
2. Once the oven has cooled down for about 1 HOUR and the "Door Lock" light has gone out, the oven door can be opened.
3. Restart the Self-Clean cycle once all conditions have been corrected.

**NOTE:** A smoke eliminator in the oven vent converts most of the soil into a colorless vapor.

**CAUTION** To avoid possible burns use care when opening the oven door after the Self-Cleaning cycle. Stand to the side of the oven when opening the door to allow hot air or steam to escape.

**CAUTION DO NOT** force the oven door open. This can damage the automatic door locking system. Use caution and avoid possible burns when opening the door after the Self-Cleaning cycle has completed. The oven may still be **VERY HOT**.

# General Care & Cleaning

## Cleaning Various Parts of Your Oven

Before cleaning any part of the oven, be sure all controls are turned OFF and the oven is COOL. REMOVE SPILLOVERS AND HEAVY SOILING AS SOON AS POSSIBLE. REGULAR CLEANINGS NOW WILL REDUCE THE EXTENT AND DIFFICULTY OF MAJOR CLEANING LATER.

Surfaces	How to Clean
Aluminum (Trim Pieces) & Vinyl	Use hot, soapy water and a cloth. Dry with a clean cloth. Do not scour or use all-purpose cleaners, ammonia, powdered cleaners or commercial oven cleaner. They can scratch and discolor aluminum.
Painted and Plastic Control Panel, Body Parts, and Decorative Trim	<p>For general cleaning, use hot, soapy water and a cloth. For more difficult soils and built-up grease, apply a liquid detergent directly onto the soil. Leave on soil for 30 to 60 minutes. Rinse with a damp cloth and dry. <b>DO NOT</b> use abrasive cleaners on any of these materials; they can scratch.</p> <p>To remove control knobs, turn to the OFF position; grasp firmly and pull straight off the shaft. To replace knobs after cleaning, line up the flat sides of both the knob and the shaft; then push the knob into place.</p>
Stainless Steel, Chrome Control Panel, Decorative Trim	<p>Before cleaning the control panel, turn all controls to OFF and remove the control knobs. To remove, pull each knob straight off the shaft. Clean using hot, soapy water and a dishcloth. Rinse with a clean water using a dishcloth. Be sure to squeeze excess water from the cloth before wiping the panel; especially when wiping around the controls. Excess water in or around the controls may cause damage to the appliance. To replace knobs after cleaning, line up the flat sides of both the knob and the shaft; then push the knob into place.</p> <p>Clean <b>stainless steel</b> with hot, soapy water and a dishcloth. Rinse with clean water and a cloth. <b>Do not use cleaners with high concentrations of chlorides or chlorines.</b> Do not use harsh scrubbing cleaners. Only use kitchen cleaners that are especially made for cleaning stainless steel. Always be sure to rinse the cleaners from the surface as bluish stains may occur during heating that cannot be removed.</p>
Porcelain Enamel Broiler Pan and Insert (some models), Door Liner, Body Parts	Gentle scouring with a soapy scouring pad will remove most spots. Rinse with a 1:1 solution of clear water and ammonia. <i>If necessary</i> , cover difficult spots with an ammonia-soaked paper towel for 30 to 40 minutes. Rinse with clean water and a damp cloth, and then scrub with a soap-filled scouring pad. Rinse and wipe dry with a clean cloth. Remove all cleaners or the porcelain may become damaged during future heating. <b>DO NOT</b> use spray oven cleaners on the cooktop.
Oven Racks	<p>This oven comes with lubricated porcelain oven racks, which can remain in the oven during the self-clean cycle. Do not clean this vegetable oil lubrication off the racks. It is important that the sides of the oven racks always have a light coating of vegetable oil. To maintain optimal rack performance, re-apply a thin layer of vegetable oil to the sides of the rack after every self-clean cycle or when the rack becomes difficult to slide.</p> <p>For some models with chrome oven racks, clean by using a mild, abrasive cleaner following manufacturer's instructions. Rinse with clean water and dry.</p>
Oven Door	<p>Use soap &amp; water to thoroughly clean the top, sides and front of the oven door. Rinse well. You may use a glass cleaner on the outside glass of the oven door. <b>DO NOT</b> immerse the door in water. <b>DO NOT spray or allow water or the glass cleaner to enter the door vents.</b> <b>DO NOT</b> use oven cleaners, cleaning powders or any harsh abrasive cleaning materials on the outside of the oven door.</p> <p><b>DO NOT</b> clean the oven door gasket. The oven door gasket is made of a woven material, on Self-Cleaning models, which is essential for a good seal. Care should be taken not to rub, damage or remove this gasket.</p>

ENGLISH

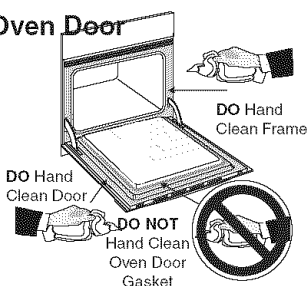
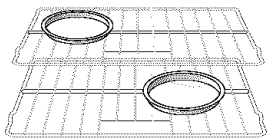

## General Care & Cleaning

### Cleaning the Porcelain Enamel Oven (Manual Clean Oven Only)

Porcelain has a smooth finish and is a type of glass fused to metal. Oven cleaners can be used on all interior oven surfaces.

REMOVE SPILLOVERS AND HEAVY SOILING AS SOON AS POSSIBLE.

**REGULAR CLEANINGS NOW WILL REDUCE THE EXTENT AND DIFFICULTY OF MAJOR CLEANINGS LATER.**

**Adhere to the following cleaning precautions:**

- Allow the oven to cool before cleaning.
- Wear rubber gloves when cleaning the appliance manually.

#### General Cleaning

Remove soils using hot, soapy water. Do not allow food spills with a high sugar or acid content (such as milk, tomatoes, sauerkraut, fruit juices or pie filling) to remain on the surface as they may cause a dull spot even after cleaning.

#### To Remove Heavy Soil

1. Allow a dish of ammonia to sit in the oven overnight or for several hours with the oven door closed. Clean softened spots using hot, soapy water. Rinse well with water and a clean cloth.
2. If soil remains, use a soap-filled scouring pad or a nonabrasive cleaner. If necessary, use an oven cleaner following manufacturer's instructions.

**⚠ CAUTION** DO NOT mix ammonia with other cleaners.

**Adhere to the following precautions when using oven cleaners:**

1. **DO NOT** spray on the electrical controls or switches because it could cause a short circuit and result in sparking or fire.
2. **DO NOT** allow a film from the cleaner to build up on the temperature sensing bulb; it could cause the oven to heat improperly. (The bulb is located in the rear of the oven.) Carefully wipe the bulb clean after each oven cleaning, being careful not to move the bulb. A change in its position could affect how the oven bakes. Avoid bending the bulb and capillary tube.
3. **DO NOT** spray any cleaner on the oven door trim or gasket, handles or any exterior surfaces of the appliance, wood or painted surfaces. The cleaner can damage these surfaces.

#### To Clean the Oven Bottom

Clean using hot, soapy water, a mild abrasive cleanser, a soap-filled abrasive pad or oven cleaner following manufacturer's instructions.

**⚠ CAUTION** Ammonia must be rinsed from all surfaces before operating the oven. Provide adequate ventilation.

**⚠ CAUTION** DO NOT line the oven walls, bottom, racks or any other part of the appliance with aluminum foil. Doing so will destroy heat distribution, produce poor baking results and cause permanent damage to the oven interior (aluminum foil will melt to the interior surface of the oven).

### Care and Cleaning of Stainless Steel (some models)

Some models are equipped with stainless steel exterior parts. Special care and cleaning are **required** for maintaining the appearance of stainless steel parts. Please refer to the table provided at beginning of the **Care & Cleaning** section in this Use & Care Manual.

## General Care & Cleaning

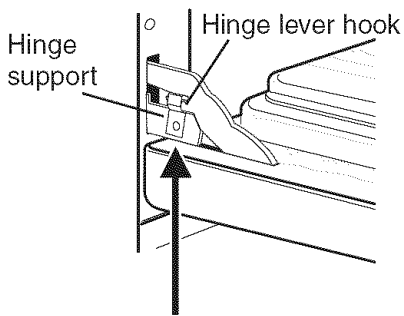

Lock engaged for door removal  
Figure 1

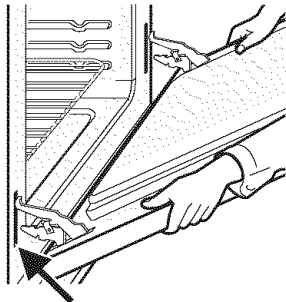

HINGE SLOT - Door removed  
from the oven  
Figure 2

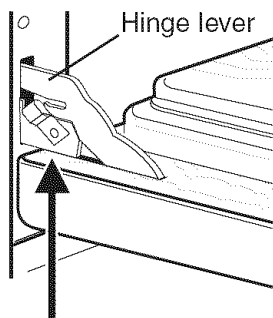

Lock in normal position  
Figure 3

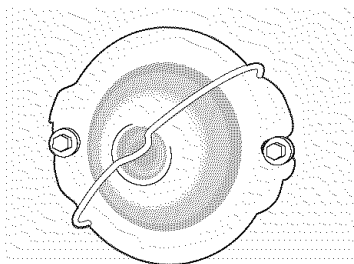

## Removing and Replacing the Oven Door

**CAUTION** The door is heavy. For safe, temporary storage, lay the door flat with the inside of the door facing down.

### To Remove Oven Door:

1. Open the door to the fully opened position.
2. Pull up the lock located on both hinge supports and engage it in the hinge lever hooks (Figure 1). You may have to apply a little downward pressure on the door to pull the locks fully over the hinge lever hooks.
3. Grab the door by the sides and pull the bottom of the door up and toward you to disengage the hinge supports. Keep pulling the bottom of the door toward you while rotating the top of the door toward the range to completely disengage the hinge levers (Figure 2).
4. To clean oven door, follow the instructions provided in the **General Care & Cleaning** table.

### To Replace Oven Door:

1. Grab the door by the sides; place the hinge supports in the hinge slots. Open the door to the fully opened position.
2. Disengage the lock from the hinge lever hooks on both sides (Figure 3).  
Note: Make sure the hinge supports are fully engaged before unlocking the hinge levers.
3. Close the oven door.

## Special Door Care Instructions

Most oven doors contain glass that can break.

Read the following recommendations:

1. Do not close the oven door until all the oven racks are fully in place.
2. Do not hit the glass with pots, pans, or any other object.
3. Scratching, hitting, jarring or stressing the glass may weaken its structure causing an increased risk of breakage at a later time.

## Changing the Oven Light

On some models an interior oven light will turn automatically when the oven door is opened. The oven light may be turned on when the door is closed by

pushing  located on the control panel. On some models, the lamp is covered with a glass shield held in place by a wire holder. **THE GLASS SHIELD MUST BE IN PLACE WHENEVER THE OVEN IS IN USE.**

### To replace the light bulb:



**CAUTION: BE SURE THE OVEN IS COOL.**

1. Turn the power off at the main source.
2. Wear a leather-faced glove for protection against possible broken glass.
3. Replace bulb with 40-watt appliance bulb only.
4. For models with glass shield, press holder on one side to release glass shield, change bulb and be sure to replace the glass shield.

## Adjusting the Oven Temperature

Your oven thermostat has been precisely set at the factory. This setting may differ from your previous oven, however, so your recipe times may not give you the results you expect. If you think that the oven is cooking too hot or cool for your recipe times, you can adjust the thermostat so that the oven cooks hotter or cooler than the temperature displayed.

### To Adjust Oven Temperature:

1. Press and hold  pad for 8 seconds. The display now indicates the amount of degrees offset between the original factory temperature setting and the current temperature setting. If the oven control has the original factory calibration, the display will read "0".
2. The temperature can now be adjusted up or down 35°F or 19°C, in 1°F or 1°C steps by pushing and holding the  or . Adjust until the desired amount of degrees offset appears in the display. When lowering the oven temperature, a minus sign (-) will appear before the number to indicate that the oven will be cooler by the displayed amount of degrees.
3. When you have made the desired adjustment, wait 5 seconds and the timer will go back to the time of day display.

**Note:** Oven temperature adjustment made will not change the Self-Cleaning feature temperature.

# Before You Call

## Solutions to Common Problems

**Before you call for service**, review this list. It may save you time and expense. The list includes common occurrences that are not the result of defective workmanship or materials in this appliance.

OCCURRENCE	POSSIBLE CAUSE/SOLUTION
Oven Control Beeps and Displays any F code error (example F11).	Electronic control has detected a fault condition. Press <b>STOP/CLEAR</b> to clear the display and stop the beeping. Reprogram the oven. If a fault reoccurs, record the fault number. Press <b>STOP/CLEAR</b> and call Sears or another qualified servicer.
-dr- is displayed.	The door was left open and controls set for self-cleaning cycle. Close the door and push <b>CANCEL pad</b> .
Installation.	Place oven rack in center of oven. Place a level on the oven rack. Contact installing agent if rack and cabinet cutout flooring are not level. Kitchen cabinet misalignment may make oven appear to be not level. Be sure cabinets are square and level. Contact cabinet maker to correct problem.
Entire oven does not operate.	When the oven is first plugged in, or when the power supply to the oven has been interrupted, the display will flash. The oven cannot be programmed until the clock is set. Be sure electrical cord is securely connected into the electrical junction box. Cord/plug is not installed and/or connected. Cord is not supplied with oven. Contact Sears or another qualified servicer. Service wiring not complete. Contact Sears or another qualified servicer. Power outage. Check house lights to be sure. Call your local electric company. Short in cord/plug. Replace cord/plug. Controls are not set properly. See instructions under <b>Setting Oven Controls</b> to set the controls. House fuse has blown or circuit breaker has tripped immediately following installation. House fuse may not be fully engaged. Check fuse and screw or engage circuit breaker securely. House fuse has blown or circuit breaker has tripped after the oven has been installed and previously operating. Call Sears or another qualified servicer.
Oven light does not work.	Burned-out or loose bulb. Follow the instructions under <b>Changing Oven Light</b> to replace or tighten the bulb.
Fan noise during cooking operation.	A cooling fan may automatically turn on and off to cool internal parts. This is normal, and the fan may continue to run even after oven is turned off.

ENGLISH

## Before You Call

### Solutions to Common Problems

OCCURRENCE	POSSIBLE CAUSE / SOLUTION
<b>Oven smokes excessively during broiling.</b>	Oven door is closed. Door should be open during broiling.
	Meat too close to the broiler unit. Reposition the rack to provide more clearance between the meat and the broiler. Preheat broil element for quick searing operation.
	Meat not properly prepared. Remove excess fat from meat. Slash remaining fatty edges to prevent curling, but do not cut into the lean.
	Grid on broiler pan wrong side-up. Grease does not drain into broiler pan. Always place the grid on the broiler pan with the ribs up and the slots down to allow grease to drip into the pan.
	Broiler pan used without grid or grid cover with foil. <b>DO NOT</b> use the broiler pan without the grid or cover the grid with foil.
Oven needs to be cleaned. Grease has built up on oven surfaces. Regular cleaning is necessary when broiling frequently. Old grease or food spatters cause excessive smoking.	
<b>Poor baking results.</b>	Many factors affect baking results. See <b>Baking</b> for hints, causes and corrections. See <b>Adjusting Oven Temperature</b> .
<b>Self-cleaning cycle does not work.</b>	Make sure the oven door is closed.
	Controls not set properly. Follow instructions.
	Self-cleaning cycle was interrupted. Stop time must be set 2-4 hours past the start time. Follow steps under "Stopping or Interrupting a Self-Cleaning Cycle" in this Use & Care Guide.
<b>Soil not completely removed after self-cleaning cycle is completed.</b>	Failure to clean bottom, from top of oven, frame of oven or door area outside oven seal. These areas are not in the self-cleaning area, but get not enough to burn on residue. Clean these areas before the self-cleaning cycle is started. Burned on residue can be cleaned with a stiff nylon brush and water or a nylon scrubber. Be careful not to damage the oven gasket.
	Excessive spillovers in oven. Set the self-clean cycle for longer cleaning time.
<b>Flames inside oven or smoke from vent.</b>	Excessive spillovers in oven. This is normal, especially for high oven temperatures, pie spillovers or for large amounts of grease on bottom of oven. Wipe up excessive spillovers.



# Notes

ENGLISH

# Get it fixed, at your home or ours!

## Your Home

For expert troubleshooting and home solutions advice:

**manage my home**

[www.managemyhome.com](http://www.managemyhome.com)

For repair – **in your home** – of **all** major brand appliances, lawn and garden equipment, or heating and cooling systems, **no matter who made it, no matter who sold it!**

For the replacement parts, accessories and owner's manuals that you need to do-it-yourself.

For Sears professional installation of home appliances and items like garage door openers and water heaters.

**1-800-4-MY-HOME<sup>®</sup>** (1-800-469-4663)

Call anytime, day or night (U.S.A. and Canada)

[www.sears.com](http://www.sears.com)    [www.sears.ca](http://www.sears.ca)

## Our Home

For repair of carry-in items like vacuums, lawn equipment, and electronics, call anytime for the location of your nearest

**Sears Parts & Repair Service Center**

**1-800-488-1222** (U.S.A.)

[www.sears.com](http://www.sears.com)

**1-800-469-4663** (Canada)

[www.sears.ca](http://www.sears.ca)

To purchase a protection agreement on a product serviced by Sears:

**1-800-827-6655** (U.S.A.)

**1-800-361-6665** (Canada)

Para pedir servicio de reparación a domicilio, y para ordenar piezas:

**1-888-SU-HOGAR<sup>®</sup>**

(1-888-784-6427)

Au Canada pour service en français:

**1-800-LE-FOYER<sup>MC</sup>**

(1-800-533-6937)

[www.sears.ca](http://www.sears.ca)

**Sears**

® Registered Trademark / <sup>TM</sup> Trademark / <sup>SM</sup> Service Mark of Sears Brands, LLC

® Marca Registrada / <sup>TM</sup> Marca de Fábrica / <sup>SM</sup> Marca de Servicio de Sears Brands, LLC

<sup>MC</sup> Marque de commerce / <sup>MD</sup> Marque déposée de Sears Brands, LLC

© Sears Brands, LLC

## Free Manuals Download Website

<http://myh66.com>

<http://usermanuals.us>

<http://www.somanuals.com>

<http://www.4manuals.cc>

<http://www.manual-lib.com>

<http://www.404manual.com>

<http://www.luxmanual.com>

<http://aubethermostatmanual.com>

Golf course search by state

<http://golfingnear.com>

Email search by domain

<http://emailbydomain.com>

Auto manuals search

<http://auto.somanuals.com>

TV manuals search

<http://tv.somanuals.com>