

**Use & Care Guide**  
**Manual de Uso y Cuidado**  
English / Español

Models/Modelos: 790.4943\*, 790.4941\*

# Kenmore®

## Wall Oven

## Horno de pared doble

\* = color number, número de color

P/N 139900100 Rev A

Sears Brands Management Corporation  
Hoffman Estates, IL 60179 U.S.A.  
[www.kenmore.com](http://www.kenmore.com)  
[www.sears.com](http://www.sears.com)

Sears Canada Inc.  
Toronto (Ontario) Canada M5B 2C3  
[www.sears.ca](http://www.sears.ca)



# Table of Contents

Please carefully read and save these instructions .....	2	Care and Cleaning .....	17
Kenmore Limited Warranty .....	2	Cleaning Various Parts of Your Oven .....	17
Before setting oven controls .....	6	Removing and Replacing the Oven Door .....	18
Oven vent location .....	6	Replacing the oven light .....	19
Oven Controls .....	7	Before You Call .....	20
		Oven Baking .....	20
		Solutions to Common Problems .....	21

---

## Kenmore Limited Warranty

When installed, operated and maintained according to all instructions supplied with the product, if this appliance fails due to a defect in material and workmanship within one year from the date of purchase, call 1-800-4-MY-HOME® to arrange for free repair. This warranty applies for only 90 days from the date of purchase if this appliance is ever used for other than private family purposes.

### **This warranty covers only defects in material and workmanship. Sears will NOT pay for:**

1. Cracks in a ceramic glass cooktop that are not a result of thermal shock.
2. Stains and scratches on a ceramic glass cooktop resulting from failure to maintain it properly according to all instructions supplied with the product.
3. Expendable items that can wear out from normal use, including but not limited to filters, belts, light bulbs, and bags.
4. A service technician to instruct the user in correct product installation, operation or maintenance.
5. A service technician to clean or maintain this product.
6. Damage to or failure of this product if it is not installed, operated or maintained according to all instructions supplied with the product.
7. Damage to or failure of this product resulting from accident, abuse, misuse or use for other than its intended purpose.
8. Damage to or failure of this product caused by the use of detergents, cleaners, chemicals or utensils other than those recommended in all instructions supplied with the product.
9. Damage to or failure of parts or systems resulting from unauthorized modifications made to this product.

### **Disclaimer of implied warranties; limitation of remedies**

Customer's sole and exclusive remedy under this limited warranty shall be product repair as provided herein. Implied warranties, including warranties of merchantability or fitness for a particular purpose, are limited to one year or the shortest period allowed by law. Sears shall not be liable for incidental or consequential damages. Some states and provinces do not allow the exclusion or limitation of incidental or consequential damages, or limitation on the duration of implied warranties of merchantability or fitness, so these exclusions or limitations may not apply to you.

This warranty applies only while this appliance is used in the United States or Canada.

This warranty gives you specific legal rights, and you may also have other rights which vary from state to state.\*

\* Sears Canada Inc. exclusive conditions:

- In-home repair service is not available in all Canadian geographical areas, nor will this warranty cover user or servicer travel and transportation expenses if this product is located in a remote area (as defined by Sears Canada Inc.) where an authorized servicer is not available.

**Sears Brands Management Corporation, Hoffman Estates, IL 60179 U.S.A.**  
**Sears Canada Inc., Toronto, Ontario, Canada M5B 2C3**

# IMPORTANT SAFETY INSTRUCTIONS

Read all instructions before using this appliance.

This manual contains important safety symbols and instructions. Pay attention to these symbols and follow all instructions given.

Do not attempt to install or operate your appliance until you have read the safety precautions in this manual. Safety items throughout this manual are labeled with a WARNING or CAUTION statement based on the hazard type.

## DEFINITIONS

**⚠** This is the safety alert symbol. It is used to alert you to potential personal injury hazards. Obey all safety message that follow this symbol to avoid possible injury or death.

**⚠ WARNING** - Indicates a potentially hazardous situation which, if not avoided, may result in death or serious injury.

**⚠ CAUTION** - Indicates a potentially hazardous situation which, if not avoided, may result in minor or moderate injury.

**⚠ WARNING** Storage In or On Appliance—Flammable materials should not be stored in an oven. This includes paper, plastic, and cloth items, such as cookbooks, plastic ware, and towels, as well as flammable liquids. Do not store explosives, such as aerosol cans, on or near the oven.

**⚠ WARNING** Do Not Leave Children Alone - Children should not be left alone or unattended in the area where appliance is in use. They should never be allowed to sit or stand on any part of the appliance, including the storage drawer, lower broiler drawer, warmer drawer, or lower double oven.

**⚠ CAUTION** When heating fat or grease, watch it closely. Grease may catch fire if it becomes too hot.

## **⚠ WARNING** Tip Over Hazard



- A child or adult can tip the oven and be killed.
- Install the anti-tip device to oven and/or structure per installation instructions.

- Ensure the anti-tip device is re-engaged when the oven is moved.
- Do not operate the oven without the anti-tip device in place and engaged.
- Failure to follow these instructions can result in death or serious burns to children and adults.

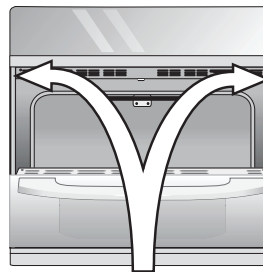

Anti-tip mounting holes

Refer to the installation instructions supplied with your appliance for proper installation.

Check for proper installation with a visual check that the anti-tip screws are present.

Test the installation with light downward pressure on the open oven door. The oven should not tip forward.

**⚠ WARNING** Stepping, leaning, or sitting on the door or drawers of an oven can result in serious injuries and also cause damage to the appliance. Do not allow children to climb or play around the oven. The weight of a child on an open oven door may cause the oven to tip, resulting in serious burns or other injury.

**⚠ WARNING** Never cover any slots, holes, or passages in the oven bottom or cover an entire oven rack with materials, such as aluminum foil. Aluminum foil linings may trap heat, causing a fire hazard.

Save these instructions for future reference.

# IMPORTANT SAFETY INSTRUCTIONS

Read all instructions before using this appliance.

**⚠ CAUTION** Wear proper apparel. Loose-fitting or hanging garments should never be worn while using this appliance. Do not let clothing or other flammable materials come into contact with hot surfaces.

**⚠ CAUTION** Do not heat unopened food containers. Build-up of pressure may cause container to burst and result in injury.

**⚠ CAUTION** Do not use water or flour on grease fires. Cover the fire with a pan lid, use baking soda, or use a dry chemical or foam type extinguisher.

**⚠ CAUTION** Use dry potholders. Moist or damp potholders on hot surfaces may result in burns from steam. Do not let potholders touch hot cooking areas. Do not use towels or other bulky cloths.

**⚠ WARNING** The California Safe Drinking Water and Toxic Enforcement Act requires the governor of California to publish a list of substances known to cause cancer, birth defects, or other reproductive harms, and it requires businesses to warn customers of potential exposures to such substances.

**⚠ WARNING** Read and follow all the warnings, cautions and important notes regarding the instructions and precautions for unpacking, installing, and servicing your appliance:

Remove all tape and packaging before using the oven. Destroy the carton and plastic bags after unpacking the oven. Never allow children to play with packaging material.

**⚠ CAUTION** Do not touch heating elements or interior surfaces of oven. Heating elements may be hot even though they are dark in color. Interior surfaces of ovens become hot enough to cause burns. During and after use, do not touch, or let clothing or other flammable materials contact heating elements or interior surfaces of oven until they have sufficient time to cool. Other surfaces of the appliance may become hot enough cause burns such as the oven door, windows, and the oven vent.

- Remove the oven door from any unused oven if it is to be stored or discarded.

- Proper Installation—Be sure your appliance is properly installed and grounded by a qualified technician in accordance with the National Electrical Code ANSI/NFPA No. 70 latest edition and local electrical code requirements. In Canada, install in accordance with CSA Standard C22.1, Canadian Electrical code, Part 1, and local electrical code requirements. Install only per installation instructions provided in the literature package for this oven.
- User Servicing—Do not repair or replace any part of the appliance unless specifically recommended in the manuals. All other servicing should be done only by a qualified technician. This reduces the risk of personal injury and damage to the oven.
- Ask your dealer to recommend a qualified technician and an authorized repair service. Know how to disconnect the power to the oven at the circuit breaker or fuse box in case of an emergency.
- Never modify or alter the construction of an oven by removing the leveling legs, panels, wire covers, anti-tip brackets/screws, or any other part of the oven.
- Do not attempt to operate the oven during a power failure. If the power fails, always turn off the oven. If the oven is not turned off and the power resumes, the oven will begin to operate again. Once the power resumes, reset the clock and oven function.

Save these instructions for future reference.

# IMPORTANT SAFETY INSTRUCTIONS

Read all instructions before using this appliance.

- Cold temperatures can damage the electronic control. When using this appliance for the first time, or when the appliance has not been used for an extended period of time, be sure the appliance has been in temperatures above 32°F (0°C) for at least 3 hours before turning on the power to the appliance.
- Be sure to have an appropriate foam-type fire extinguisher available, visible, and easily located near the appliance.

## IMPORTANT INSTRUCTIONS FOR USING YOUR OVEN

- Never use your appliance for warming or heating the room.
- Use care when opening oven door, lower oven door, or warmer drawer (some models). Stand to the side of the oven when opening the door of a hot oven. Let hot air or steam escape before you remove or replace food in the oven.
- Keep oven vent ducts clear. Touching surfaces in this area when the oven is on may cause severe burns. Do not place plastic or heat-sensitive items on or near the oven vent. These items can melt or ignite.
- Always handle oven racks when the oven is cool. Place oven racks in desired positions while the oven is cool. If a rack must be moved while the oven is hot, use extreme caution. Use potholders and grasp the rack with both hands to reposition. Do not let potholders contact the hot heating elements in the oven. Remove all

bakeware and utensils before moving the rack.

- Do not use a broiler pan without its insert. Do not cover the broiler insert with aluminum foil; exposed fat and grease could ignite.
- Do not use aluminum foil or other protective liners to line the oven bottom. Only use aluminum foil as recommended in this manual. Improper installation of these liners may result in risk of electric shock or fire.
- Do not cook food on the oven bottom. Always use proper bakeware and use the oven racks

## IMPORTANT INSTRUCTIONS FOR CLEANING YOUR OVEN

**⚠ CAUTION** Before manually cleaning any part of the oven, be sure all controls are turned off and the oven is cool. Cleaning a hot oven can cause burns.

Clean the oven regularly to keep all parts free of grease that could catch fire. Do not allow grease to accumulate. Always follow the manufacturer's recommended directions for use of kitchen cleaners and aerosols. Be aware that excess residue from cleaners and aerosols may ignite causing damage and injury.

Clean ventilating hoods frequently. Grease should not be allowed to accumulate on the hood or filter. Follow the manufacturer's instructions for cleaning hoods.

Save these instructions for future reference.

# IMPORTANT SAFETY INSTRUCTIONS

Read all instructions before using this appliance.

## SELF-CLEANING OVENS

- Use the self-clean cycle to clean only the parts listed in this manual. Before using self-clean, remove the broiler pan, any food, utensils, and bakeware from the oven. Remove oven racks unless otherwise instructed.
- Do not use oven cleaners. No commercial oven cleaner, oven liner, or protective coating of any kind should be used in or around any part of the oven.
- Do not clean the oven door gasket. The door gasket is essential for a good seal. Do not rub, damage, or move the gasket.
- Some birds are extremely sensitive to the fumes given off during the self-clean cycle of any oven. Move birds to another well-ventilated room.

## GROUNDING INSTRUCTIONS

**⚠ WARNING** Do not use an adapter plug or an extension cord, or remove grounding prong from the power cord. Failure to follow this warning may cause serious injury, fire, or death.

For personal safety, this appliance must be properly grounded.

### **For models factory-equipped with a power cord:**

For maximum safety, the power cord must be plugged into an electrical outlet that is the correct voltage, is correctly polarized, and properly grounded in accordance with local codes.

### **For ovens to be wired into a junction box:**

It is the personal responsibility of the consumer to have the appropriate outlet with the correct, properly grounded wall receptacle installed by a qualified electrician. See the installation instructions packaged with this appliance for complete installation and grounding instructions.

Save these instructions for future reference.

# Before setting oven controls

## Oven vent location

The oven vent is located under the left side of the control panel (Figure 1). When the oven is on, warm air passes through this vent. This venting is necessary for proper air circulation in the oven and good baking results. Steam or moisture may appear near the oven vent, this is normal. Do not block oven vent:

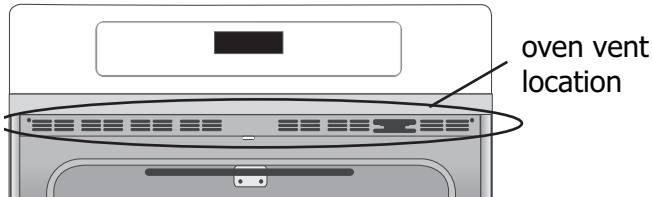

Figure 1:

**CAUTION** Always use pot holders or oven mitts when using the oven. When cooking, the oven interior and exterior and oven racks will become very hot which can cause burns.

**WARNING Protective Liners** — Do not use aluminum foil to line the oven bottom. Only use aluminum foil as recommended in this manual. Improper installation of these liners may result in risk of electric shock, or fire

## Removing, arranging and replacing racks

**Arranging** - always arrange the oven racks when the oven is cool.

**To remove** - pull the rack forward until it stops. Lift up front of rack and slide out.

**To replace** - fit oven rack onto the rack guides on both sides of oven walls. Tilt the front of oven rack upward and slide the rack back into place. Be sure oven racks are level before using.

## Type of oven racks

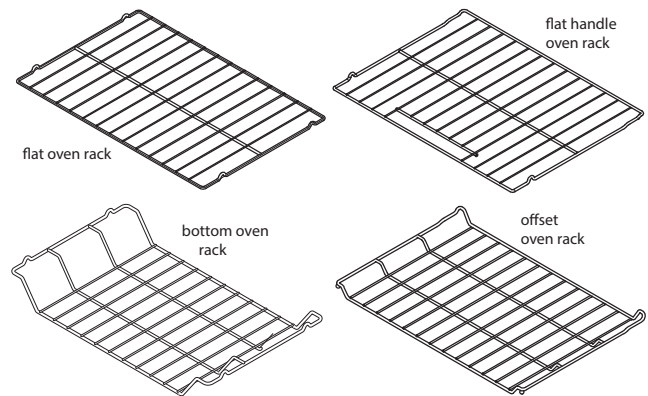

Figure 2:

The flat oven rack (some models) or flat handle oven rack (some models) may be used for most cooking needs.

The offset oven rack (on some models) is designed to place the base of the rack about 1/2 of a rack position lower than flat oven racks. This design allows several additional positions between the flat rack positions.

To maximize oven cooking space place the **bottom oven rack** (on some models) in the lowest rack position for roasting large cuts of meat.

## Air circulation in the oven

For best baking results allow 2-4" (5-10 cm) around the cookware for proper air circulation and be sure pans and cookware do not touch each other, the oven door, sides or back of the oven cavity. Hot air must be able to circulate around the cookware in the oven for even heat to reach around the food.

# Oven Controls

READ THE INSTRUCTIONS CAREFULLY BEFORE USING THE OVEN. For satisfactory use of your oven, become familiar with the various features and functions of the oven as described below. Detailed instructions for each feature and function follow later in this Use & Care Guide.

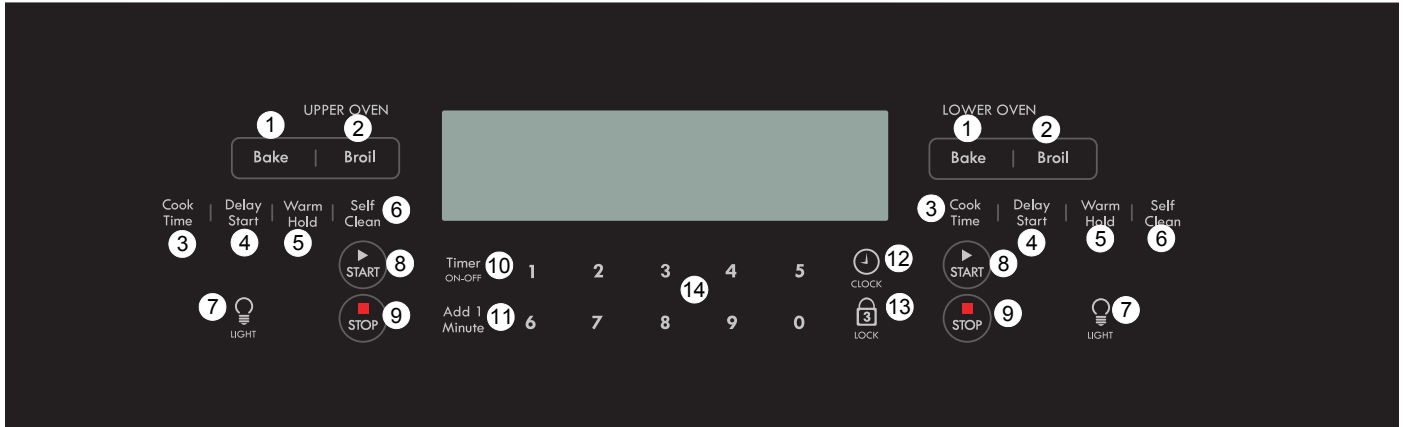

1. **Bake** - Used to enter the normal bake feature.
2. **Broil** - Used to select variable broil feature.
3. **Cook Time** - Used to enter the length of the cook time desired.
4. **Delay Start** - Used to set the desired start time for baking. May be used with Cook Time to program a delayed timed bake or clean cycle.
5. **Warm & Hold** - Used to set the Warm & Hold function.
6. **Self Clean** - Used to set a 2 to 4 hours Self-Clean cycle.
7. **Oven Light** - Used to turn oven light on and off.
8. **START** - Used to start all oven features (except Oven Light).
9. **STOP** - Used to cancel any oven function except Clock and Timer.
10. **Timer on-off** - Used to set or cancel Timer. The minute timer does not start or stop cooking.
11. **Add 1 Minute** - Used to add additional minutes to Timer.
12. **Clock** - Used to set the time of day.
13. **Oven Lockout** - Used to lock the oven keys and oven door
14. **Numeric Keypad** - Used to enter temperature and times.

## Minimum & maximum control settings



All of the features listed below have minimum and maximum time or temperature settings that may be entered into the control. An entry acceptance beep will sound each time a control key is touched (the Oven Lockout is delayed 3 seconds).

An entry error tone (3 short beeps) will sound if the entry of the temperature or time is below the minimum or above the maximum settings for the feature.

Feature	Min temp. or time	Max temp or time
Bake	170°F/77°C	550°F/288°C
Broil	400°F/205°C	550°F/288°C
Timer	0:01 Min.	11:59 Hr./Min.
Self Clean	2 hours	4 hours
Cook Time	0:01 Min.	11:50 Hr./Min.
Delay Time 12 Hr.	1:00 Hr./Min.	12:59 Hr./Min.
Delay Time 24 Hr.	0:00 Hr./Min.	23:59 Hr./Min.



## Setting the Clock

The  key is used to set the clock. The clock may be set for 12 or 24 hour time of day operation. The clock has been preset at the factory for the 12 hour operation. When the range is first plugged in, or when the power supply to the range has been interrupted, the time in the display will flash. Press . The display will stop flashing.

**Example: Setting the clock for 1:30:**

1. Press . CLO will appear in the display.)





2. Press **1 3 0** keys to set time of day. Press .
3. Time of day will now appear in the display.



## Changing between 12 or 24 hour time of day display

1. Press and hold  for 7 seconds until 12Hr or 24Hr appears in the display.
2. Press **Self-Clean** to switch between the 12 and 24 hour time of day displays. The display will show either 12Hr or 24Hr (figure)



3. Press  to accept the change or press  to reject.
4. Reset the correct time as prescribed in Setting the Clock above. Note: if the 24 hour time of day was selected, the clock will now display time from 0:00 through 23:59 hours.

## Setting Continuous Bake or 12 Hour Energy Saving

The **Timer on-off** and **Self-Clean** keys control the Continuous Bake or 12 hour Energy Saving features. The oven control has a factory preset 12 Hour Energy Saving feature that shuts off the oven control if left on for more than 11 hours and 59 minutes. The oven can be programmed to override this feature for Continuous baking.

**To set the Continuous Bake or 12 Hour Energy feature:**

1. Press and hold **Timer on-off** for about 7 seconds. The dashes will change to show either **12Hr OFF** or **Stay On** in the display and the control will beep once.



2. Press **Self-Clean** to switch between the 12Hr Energy saving and Continuous Bake features. Note: **12 Hr OFF** indicates the control is set for the 12 hour energy saving mode. **Stay On** indicates the control is set for the Continuous Bake mode.
3. Press  to accept your selection and the display will return to show the time of day.

## Setting Oven Timer

The **Timer on-off** controls the Timer and serves as an extra timer that will beep when the set time has run out. It does not start or stop cooking. The Timer feature can be used during any of the other oven control functions, except Self-Clean and Sabbath.

**To set Timer (example 5 minutes)**

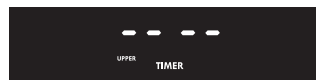

1. Press **Timer on-off**. When dashes appear in the display press the number 5 key (for this example) and press . The time will begin to count down.
2. Note: If the start key is not pressed timer will return to time of day after 30 seconds.



3. When timer runs out, End and TIMER show in display. The clock will beep 3 times every 30 seconds until **Timer on-off** is pressed. Press **Timer on-off** to cancel the timer at any time. Once canceled the display show the time of day.

## Oven Controls

### To Set Add 1 Minute Feature

The  key is used to set the Add 1 Minute feature. When the key is pressed, 1 minute is added to the Timer feature if this feature is already active. If the Minute Timer feature is not active and the  is pressed, the Timer feature will become active and will begin counting down from 1 minute. For further information on how to set the Minute Timer feature see To Set the Minute Timer instructions above..

### Setting the Oven Lockout

The  controls the Oven Lockout feature. The Oven Lockout feature automatically locks the oven door and prevents the oven from being turned on. It does not disable the clock, Timer or the interior oven lights. The ovens can be locked individually.

#### To activate the Oven lockout feature:

1. Press and hold  for 3 seconds.
2. After 3 seconds, DOOR, LOCKED will flash and **Loc** will appear in the display



Once the oven door is locked the **DOOR** and **LOCKED** indicator will stop flashing and remain in the display. Allow 15 seconds for the oven door to lock.

#### To reactivate normal oven operation by unlocking door:

1. Press and hold  for 3 seconds. **Loc** will disappear from the display. **DOOR** and **LOCKED** will flash in the display until the door has completely unlocked and the oven will be operational.

### Operating Oven Lights

The interior oven lights will turn ON when the oven door is opened.

Press  to turn oven light ON an OFF whenever the oven door is closed.

The interior oven lights are located on the rear wall of the oven interior and are covered with a glass shield. The glass shield protects the bulb from high temperatures and should always be in place whenever the oven is in use.

To replace the interior oven lights, see **Replacing oven lights** in the Care and Cleaning section.

### Setting Silent Control Operation

The **Self-Clean** and **Delay Start** keys control the Silent Control operation feature. The Silent Control operation feature allows the oven control to be operated without sounds or beeps whenever necessary. If desired the control can be programmed for silent operation and later returned to operating with all the normal sounds and beeps.

#### To change from normal sound to silent operation:

1. Press and hold **Delay Start** for 7 seconds. The display will show dashes and then change to **bEEP ON** in the display.



2. Press **Self-Clean** to switch between normal sound operation and silent mode (beep off).



Press  to accept the change or press  to reject the change.

Note: The control will always beep at the end of a timer and will beep when a set temperature has been reached, even if the control is set to silent operation.

### Restoring factory default settings

Your appliance is programmed with default control settings. Over time, users may make changes to these settings. The following options have settings that can be modified and may have been changed since the appliance was new:

- 12 or 24 hour display mode
- Continuous bake or 12-Hour Energy Savings mode
- Silent or audible control
- Oven temperature display (Fahrenheit or Celsius)
- Oven temperature adjustments (offsets)
- Stored recipes

If you choose to restore factory default settings, ALL of the above user preferences will be restored to their original settings (factory default). The oven temperature offset will reset and any stored recipes will be cleared.

#### To restore oven control to factory default settings:

1. When the oven is in idle and no cooking function is in operation, press and hold the **7** key until the acceptance tone sounds (about 6 seconds)
2. Press **START**. The control is now reset to default settings.

## Setting Temperature display -- Fahrenheit or Celsius

The **Broil** and **Self-Clean** keys control the Fahrenheit or Celsius temperature display modes. The oven control can be programmed to display temperatures in Fahrenheit or Celsius. The oven has been preset at the factory to display in Fahrenheit. Note: both ovens will be changed at the same time.

**To change display from Celsius to Fahrenheit or Fahrenheit to Celsius:**

1. Press and hold **Broil** for about 6 seconds. A beep will sound, **550** will appear **BROIL** will flash in the display. Continue to hold key until it beeps and **F** or **C** appears in the display. The **F** means the oven is set for temperatures in Fahrenheit and the **C** showing means the oven is set for temperatures to display in Celsius.



2. Press **Self-Clean** and toggle to switch between Fahrenheit or Celsius modes.
3. Press  to accept the change.

## Adjusting Oven Temperature

Before adjusting, test a recipe by using a temperature setting higher or lower than the recommended temperature. The results will help you to decide how much of an adjustment is needed. If the oven is cooking too hot or too cool for the temperature you select, you can adjust the actual oven temperature to be more or less than what is displayed. The temperature in the oven is preset at the factory to **UPO 0**.

**To adjust the oven temperature higher:**

1. Press **Bake** for 6 seconds. **UPO 0** will appear in the display.
2. To increase the temperature use the number keys to enter the desired change (Example 30°F) 3 0. The temperature may be increased as much as 35°F (19°C).
3. Press  to accept the temperature change and the display will return to the time of day.

**To adjust the oven temperature lower:**

1. Press **Bake** for 6 seconds. **UPO 0** will appear in the display.
2. To decrease the temperature use the number keys to enter the change (Example -30°F) 3 0 and then press **Self-Clean**. The temperature may be decreased as much as 35°F (19°C).
3. Press  to accept the temperature change and the display will return to the time of day.
4. Press **STOP** to reject the change if necessary.

## Setting Cook Time

The **Bake** and **Cook Time** keys control the Cook Time feature. The automatic timer of the Cook Time feature will turn the oven off after cooking for the desired amount of time you selected.

**To program the oven to begin baking immediately and to shut off automatically (example: Bake at 350°F for 30 minutes)**

1. Be sure the clock is set for the correct time of day
2. Arrange oven racks and place food in oven.
3. Press **Bake**.
4. Press . The actual oven temperature will appear in the display..



5. Press **Cook Time**. Dashes will appear in the display.



6. Enter desired bake time by pressing **30**. **Note:** Baking time can be set for any time between 1 minute and 11 hours and 59 minutes
7. Press . The display returns to the time of day (shown here as 1:30).



To check the bake time remaining, press **cook time once** and the time left in the baking process will appear for a few seconds in the display. A beep will sound once the oven has reached the set temperature. When the bake time finishes, **END** and the time of day will show in the display and the oven turns off automatically. The control will beep 3 times and continue to beep every 30 seconds until  is pressed.



## Oven Controls

### Setting Delay Start

The **Bake**, **Cook Time**, and **Delay Start** keys control the **Delay Start** feature. The automatic timer of the Delay Start will turn the oven on and off at the time you select in advance.

**Note:** If the clock is set for normal 12 hour display mode the Delayed Time Bake or Delayed Timed Convection Bake cycle can not be set to start more than 12 hours in advance.

**To program the oven for a delayed BAKE start time and to shut off automatically** (example: baking at 350°F for 30 minutes and starting at 5:30)

1. Be sure that the clock is set with the correct time of day.
2. Arrange oven rack(s) and place the food in the oven.
3. Press **Bake**
4. Press . The actual oven temperature will be displayed.



5. Press . Dashes will appear in the display.



6. Enter the desired baking time by using the numeric keypad and pressing **3 0**. Press .
7. Press **Delay Start**. Dashes will appear in the display.



8. Enter the desired start time using the numeric keypad **5 3 0**.



9. Press . The current time of day will appear in the display. The set temperature will also show in the display.



10. When the desired start time is reached, the oven icon will appear in the display and the oven will start to bake at the previously selected temperature.
11. Press  when baking is finished or at any time to cancel the Delayed Time Bake feature.

### When the bake time runs out:

1. **END** will appear in the display and the oven will turn off automatically.



2. The control will beep 3 times. The control will continue to beep 3 times every 30 seconds until **STOP** is pressed.

**CAUTION FOOD POISONING HAZARD.** Do not let food sit for more than one hour before or after cooking. Doing so can result in food poisoning or sickness. Foods that can easily spoil such as milk, eggs, fish, meat or poultry, should be chilled in the refrigerator first. Even when chilled, they should not stand in the oven for more than 1 hour before cooking begins, and should be removed promptly when finished cooking.

### Warm & Hold™

Warm & Hold will keep cooked foods warm and ready for serving for up to 3 hours after cooking has finished. After 3 hours the Warm & Hold will shut off automatically. Warm & Hold should only be used with foods that are already at serving temperatures. Warm & Hold will maintain the oven temperature at 170° F (77°C).

#### Example - To set Warm & Hold:

1. Press **Warm & Hold**. **Hld** will appear in the display.
2. Press **START**. Warm & Hold will automatically turn off after 3 hours.

To turn Warm & Hold off at any time press **STOP**.

**To set Warm & Hold to turn on automatically once a bake time is set or while the oven is baking:**



3. Press **Warm & Hold**.
4. Press **START**. The oven is now set to turn on automatically after the Timed Bake or Delay Start Bake has finished.

## Setting Bake

Use the bake feature whenever the recipe calls for baking using normal temperatures. A reminder tone will sound indicating when the set baking temperature is reached and to place the food in the oven.

Bake may be set for any oven temperature between 170°F (77°C) to 550°F (288°C).

### To set Bake with a default temperature of 350°F:

1. Press **Bake**.
2. Press  .
3. To cancel Bake at any time, press  .

### To set Bake for an oven temperature of 425°F:

1. Press **Bake**.
2. Enter **4 2 5** using numeric keypad.
3. Press  .

To cancel Bake at any time, press  .

### Important note:

When setting Bake or any cooking feature that preheats the oven (except Broil), the convection fan will turn on and stay on until the oven reaches set temperature.

The oven is factory set to run no longer than 12 hours. If you wish to cook continuously, see “Changing between continuous bake setting or 12-Hour Energy Saving feature” on [page 9](#).

### Baking Tips:

- Preheat your oven before using the bake mode.
- During preheat, the three elements and the convection fan are used in cycle to quickly heat the oven.
- Use only one rack and center the pans as much as possible on rack 2 or 3.
- If using two racks, place the oven racks in positions 2 and 4.
- Allow 2" to 4" (5,1 to 10,2cm) around the bakeware for proper air circulation.
- Be sure the pans do not touch each other, the door, sides or back of the oven

**Table 1: Suggested Bake rack positions**

Food	Position
Broiling meats, chicken, fish	3 or 4
Cookies, cakes, pies, biscuits, (single rack)	2 or 3
Using multiple racks for items above	2 and 4
Frozen pies, angel food cake, yeast bread, 1 or 2 casseroles, small cuts of meat and poultry	1 or 2
Turkey, roast beef, ham	1 or offset rack

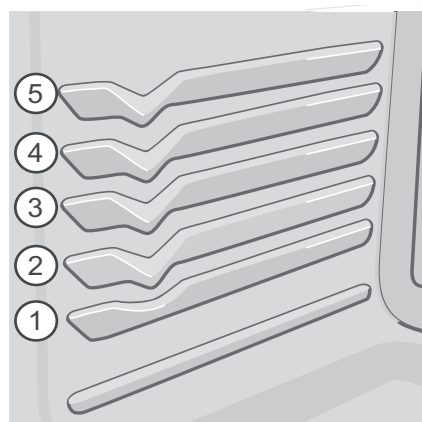

**Figure 3: Wall oven rack positions**

### Baking layer cakes with 1 or 2 oven racks:

For best baking results when baking cakes or cookies using 2 oven racks, place bakeware in rack positions 3 and 5 (for rack 5 use the offset rack if provided).

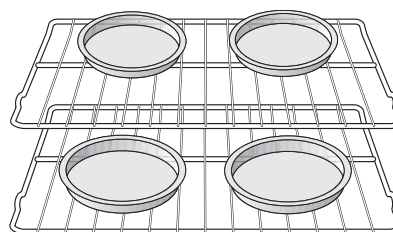

**Figure 4: Pan spacing for best results when baking**

## Setting Broil

The **Broil** key controls the Broil feature. When broiling, heat radiates downward from the oven broiler for even coverage. The Broil temperature may be set between 400°F and 550°F. (Table 2)

The broil pan and broil pan insert used together allow dripping grease to drain and be kept away from the high heat of the oven broiler (Figure 5). Do not use the broil pan without the insert. Do not cover the broil pan insert with foil. The exposed grease could catch fire. To purchase them, call Sears at 1-800-4-MY-HOME (1-800-469-4663) and order broiler pan kit 5304442087.

**CAUTION** The broil burner may appear to have cooled after it has been turned off. The burners may still be hot and burns may occur if these burners are touched before they have cooled sufficiently.

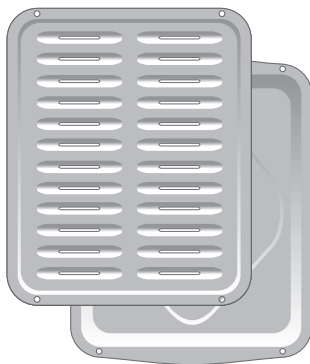



Figure 5: Broil pan and insert

Table 2: Suggested broil temperature settings

Food Item	Rack Position	Temperature	Cook time		Doneness
			1st side	2nd side	
Steak 1" thick	3rd or 4th	550°F	6:00	4:00	Rare
	3rd or 4th	550°F	7:00	5:00	Medium
Pork Chops 3/4 "thick	3rd or 4th	550°F	8:00	6:00	Well
Chicken - Bone In	3rd	450°F	20:00	10:00	Well
Chicken Boneless	3rd or 4th	450°F	8:00	6:00	Well
Fish	3rd	500°F	13:00	-	Well
Shrimp	3rd	550°F	5:00	-	Well
Hamburger 1" thick	3rd or 4th	550°F	9:00	7:00	Medium
	3rd or 4th	550°F	10:00	8:00	Well

## To set the oven to broil at 550°F.

1. Place the broiler pan insert on the broiler pan. Then place the food on the broiler pan insert.
2. Arrange the interior oven rack and place the broiler pan on the rack. Be sure to center the broiler pan directly under the broiler element. Preheat the oven for 5 minutes.
3. Press **Broil**.
4. If a lower broil temperature is desired (minimum broil temperature setting is 400°F), press the desired temperature before continuing.
5. Press . The oven will begin the broil function and the broil icon will appear in the display..



6. Broil on one side until food is browned; turn and cook on the second side. Season and serve. Note: Always pull the rack out to the stop position before turning or removing food.
7. To cancel broiling or if finished broiling press .

**WARNING** Should an oven fire occur, leave the oven door closed and turn off the oven. If the fire continues, throw baking soda on the fire or use a fire extinguisher. Do not put water or flour on the fire. Flour may be explosive and water can cause a grease fire to spread and cause personal injury.

## Setting the Sabbath Feature (for use on Jewish Sabbath and Holidays)



The **Cook Time** and **Delay Start** keys are used to set the Sabbath feature.

For further assistance, guidelines for proper usage, and a complete list of models with the Sabbath feature, please visit the web at [www.star-k.org](http://www.star-k.org).

The Sabbath feature may only be used with the Bake function. Once the oven is properly set using Bake with the Sabbath feature active, the oven will remain ON until cancelled. The Sabbath feature overrides the factory preset 12-Hour Energy Saving feature.

If the oven light is needed during the Sabbath, press Oven light before activating the Sabbath feature. Once the oven light is turned ON and the Sabbath feature is active, the oven light will remain ON until the Sabbath feature is turned OFF. If the oven light needs to be OFF, be sure to turn the oven light OFF before activating the Sabbath feature.

### To Program the Oven to Begin Baking Immediately & activate the Sabbath feature (example: baking at 350°F)

1. Be sure that the clock is set to correct time of day and place food in oven.
2. Press **Bake**.



3. Press **START**. The actual oven temperature will appear in the display.



4. If you desire to set the oven control for a Cook Time or Delay Start do so at this time. If not, skip to the next step. Refer to the Cook Time or Delay Start section for complete instructions. Remember the oven will shut down after using Cook Time or Delay Start and therefore may only be used once during the Sabbath and Jewish Holidays. The maximum Delay Start time is 11 hours & 59 minutes.
5. The oven will turn on and begin heating. If you need to set both ovens for the Sabbath, both should be set at this time.
6. Press and hold both the Cook Time and Delay Start keys for at least 3 seconds. **SAb** will appear in the display. Once **SAb** appears in the display the oven control will no longer beep or display any further changes. The oven is properly set for the Sabbath feature.



**Note:** You may change the oven temperature once baking has started. Press **Bake**, enter the oven temperature change (170 to 550°F) and then press **START twice** (for Jewish Holidays only). Remember that the oven control will no longer beep or display any further changes once the oven is set for the Sabbath feature.

The oven may be turned OFF at any time by first pressing **STOP** (this will turn the oven OFF only). To turn OFF the Sabbath feature press and hold both the Cook Time and Delay Start keys for at least 3 seconds. This also turns off the oven. **SAb** will disappear from the display.

### Power failure while using Sabbath feature:

Should you experience a power failure or interruption, the oven will shut off. When power is returned, SF (Sabbath Failure) will be displayed and the oven will not turn back on automatically. If your food was nearly fully cooked, you may allow the trapped heat in the oven to finish the cooking process. Otherwise, you should remove the food when the power failure occurs, because you may only start the oven once during the Sabbath and Jewish Holidays.

After the Sabbath observance turn OFF the Sabbath feature. Press and hold both the BAKE TIME and DELAY START keys for at least 3 seconds. SAb will disappear from the display and the oven may be used with all normal functions.

For further assistance, guidelines for proper usage, and a complete list of models with the Sabbath feature, please visit the web at [www.star-k.org](http://www.star-k.org).



## Self-Cleaning Operation

**⚠ CAUTION** During the self-cleaning cycle, the outside of the range can become very hot to the touch. Do not leave small children unattended near the appliance.

The health of some birds is extremely sensitive to the fumes given off during the self-clean cycle of any range. Move birds to another well ventilated room.

**⚠ CAUTION** Do not line the oven walls, racks, bottom or any other part of the appliance with aluminum foil. Doing so will destroy heat distribution, produce poor baking results and cause permanent damage to the interior (aluminum foil will melt to the interior surface of the oven).

Do not force the oven door open. This can damage the automatic door locking system. Use caution when opening the door after the self-cleaning cycle is completed. The oven may still be very hot.

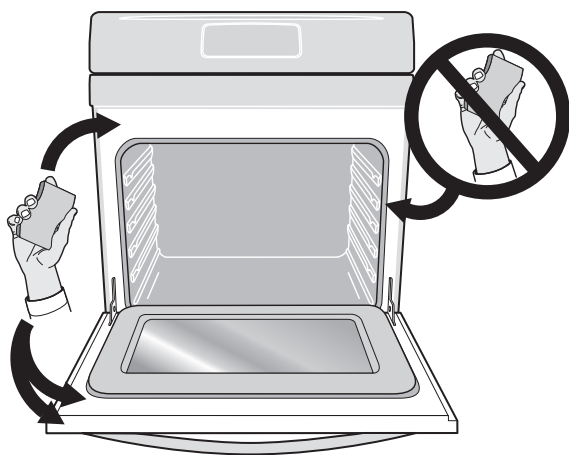

**Figure 6: Care in cleaning oven by hand**

**Note:** See additional cleaning information for the oven door in Care & Cleaning (see [page 18](#)).

## Self-Cleaning Oven

A self-cleaning oven cleans itself with high temperatures (well above cooking temperatures) which eliminate soils completely or reduces them to a fine powdered ash you can wipe away with a damp cloth.

### Adhere to the following cleaning precautions

- Allow the oven to cool before cleaning.
- Wear rubber gloves when cleaning any exterior parts of the oven manually.
- Do not use oven cleaners or oven protective coatings in or around any part of the oven interior.
- Do not clean the oven door gasket. The woven material of the oven door gasket is essential for a good seal. Care should be taken not to rub, damage or remove the gasket.
- Do not use any cleaning materials on the oven door gasket. Doing so could cause damage.
- Remove all utensils and any aluminum foil. These items cannot withstand high cleaning temperatures.
- Porcelain Coated Racks: Some ovens come with lubricated porcelain oven racks, which can remain in the oven during the self-clean cycle. Do not clean this vegetable oil lubrication off the racks. It is important that the sides of the oven racks always have a light coating of vegetable oil. To maintain optimal rack performance, re-apply a thin layer of vegetable oil to the sides of the rack after every self-clean cycle or when the rack becomes difficult to slide.
- Chrome Oven Racks: Some models come with chrome oven racks, which have to be removed from the oven during the self-clean cycle or else their finish will turn dull and their color slightly blue. If left in, after the cycle is complete and the oven has cooled, rub the sides of the oven racks with wax paper or a cloth containing a small amount of salad oil (this will make the racks glide easier into the rack position). Clean chrome oven racks by using a mild cleaner following manufacturer's instructions. Rinse with clean water and dry.
- Before starting the self-cleaning cycle, hand clean any soil from the oven frame, the door liner outside the oven door gasket, and the small area at the front center of the oven. These surfaces are not in the self-cleaning area. Clean with soap and water. Burned-on residue can be cleaned off with a stiff nylon brush and water or nylon scrubber.
- Do not hand clean the oven door gasket or it will be permanently damaged.



## To Start the Self-Clean Cycle

The **Self-Clean** key controls the self Clean feature. If you are planning to use the oven directly after a self-clean cycle remember to allow time for the oven to cool down and the oven door to unlock. This normally takes about one hour. So a 3 hour self-clean cycle will actually take about 4 hours to complete. \*It is recommend to use a 2 hour self-clean cycle for **light soils**, a 3 hour cycle for **average soils**.

**CAUTION** To avoid possible burns use care when opening the oven door after the self-cleaning cycle. Stand to the side of the oven when opening the door to allow hot air or steam to escape.

Do not force the oven door open. This can damage the automatic door locking system. Use caution and avoid possible burns when opening the door after the self-cleaning cycle has completed. The oven may still be very hot.

**To start an immediate Self-Clean cycle or to set a Delay Start time of 4:30 and shut-off automatically (example is a default 3 hour Self-Clean Cycle)**

1. Be sure clock is set for correct time of day and door is closed.
2. Press **Self-Clean**. **CLEAN** will flash and **3:00 HR** will show in the display. The oven will automatically clean for a 3 hour period (default clean cycle). Note: if a 2 or 4 hour clean time is desired, press **2 0 0** for 2 hour or **4 0 0** for a 4 hour clean time.



3. Press **START**. The **DOOR LOCKED** icon will flash; **CLEAN** icon and the letters **CLn** will remain in the display.



4. As soon as the control is set, the motor driven oven door lock will begin to close automatically. Once the door has been locked the **DOOR LOCKED** indicator light will stop flashing and remain on. Also, the oven icon will appear in the display.



**Note:** Allow 15 seconds for the oven door to lock.

**If a delay Self-Clean feature is desired, finish step 6-9.**

5. Press **Self-Clean**. Dashes will appear in the display.
6. Enter the start time numbers **4 3 0** and press **START**. **CLEAN**, **DELAY**, **LOCK**, and **DOOR** will be displayed.



7. The control will start the self-cleaning at the set start time, for the period of time previously selected. At that time, the icon **DELAY** will go out.



**When the self-clean cycle is completed:**

8. **HOT** will appear in the display. The time of day, the **DOOR LOCKED** and **CLEAN** icon will remain in the display.
9. Once the oven has cooled down for approximately 1 HOUR, and the **DOOR LOCKED** icon is no longer displayed, the oven door can then be opened.

## Stopping or Interrupting a Self-Cleaning Cycle

If it becomes necessary to stop or interrupt a self-cleaning cycle due to excessive smoke or fire in the oven:

1. Press **STOP**.
2. The oven door can only be opened after the oven has cooled down for approximately 1 HOUR and the **DOOR LOCKED** icon is no longer displayed.

**Note:** If your clock is set for normal 12 hour display mode the Delayed Self-Clean cycle can never be set to start more than 12 hours in advance. To set for Delayed Self-Clean Cycle 12-24 hours in advance set the control for the 24 hour time of day display mode.

# Care and Cleaning

## Cleaning Various Parts of Your Oven

Before cleaning any part of the oven, be sure all controls are turned off and the oven is cool. Remove spills and any heavy soiling as soon as possible. Regular cleaning will reduce the difficulty of major cleaning later.

Surface Type	Recommendation
Aluminum and Vinyl	Use hot, soapy water and a cloth. Dry with a clean cloth.
Painted body parts Painted decorative trims	Use a soft cloth and clean with mild dish detergent and water or a 50/50 solution of vinegar and water. Follow by rinsing the area with clean water; dry and polish with a soft cloth. Glass cleaners may be used if sprayed on a soft cloth first. Do not spray liquids directly on the oven control and display area. Do not use large amounts of water on the control panel. Excess water on the control area may cause damage to the appliance. Do not use other liquid cleaners, abrasive cleaners, scouring pads, or paper towels. They will damage the finish.
Easy Clean™ Stainless Steel	Your oven finish may be Easy Clean™ Stainless Steel (some models). Clean the stainless with warm soapy water using a clean sponge or cloth. Rinse with clean water and dry with a soft clean cloth. Do not use any store bought cleaners like stainless steel cleaners or any other types of cleaners containing any abrasive, chlorides, chlorine, or ammonia. It is recommended to use mild dish soap and water or a 50/50 solution of water and vinegar.
Porcelain enamel broiler pan and insert (available by mail order) Door liner and body parts	Gentle scouring with a soapy scouring pad will remove most spots. Rinse with a 1:1 solution of clear water and ammonia. If necessary, cover difficult spots with an ammonia-soaked paper towel for 30 to 40 minutes. Rinse with clean water and a damp cloth, and then scrub with a soap-filled scouring pad. Rinse and wipe dry with a clean cloth. Remove all cleaners or the porcelain may become damaged during future heating.
Oven racks	Oven racks must be removed from oven cavity. Clean by using a mild, abrasive cleaner following manufacturer's instructions. Rinse with clean water and dry.
Oven door	Use soap and water to thoroughly clean the top, sides, and front of the oven door. Rinse well. You may use a glass cleaner on the outside glass of the door. Do not immerse the door in water. Do not spray or allow water or the glass cleaner to enter the door vents. Do not use oven cleaners, cleaning powders, or any harsh abrasive cleaning materials on the outside of the oven door.  Do not clean the oven door gasket. On self-clean models, the oven door gasket is made of a woven material which is essential for a good seal. Care should be taken not to rub, damage, or remove this gasket.

## Removing and Replacing the Oven Door

**⚠ CAUTION** The door is heavy. For safe, temporary storage, lay the door flat with the inside of the door facing down.

### To remove the oven door:

1. Open oven door completely, horizontal with floor (See [Figure 7](#)).
2. Pull the door hinge locks on both left and right door hinges down from the oven frame completely toward the oven door (See [Figure 8](#)). A tool such as a small flat-blade screwdriver may be required.
3. Firmly grasp both sides of oven door along the door sides. Do not use the oven door handle (See [Figure 9](#)).
4. Close the door to approximately 10 degrees from the oven door frame.
5. Lift the oven door hinge arms over the roller pins located on each side of the oven frame (See [Figure 9](#)).

### To Replace Oven Door:

1. Firmly grasp both sides of oven door along the door sides. Do not use the oven door handle (See [Figure 9](#)).
2. Holding the oven door at the same angle as the removal position (See [Figure 9](#)), seat the hook of the hinge arm over the roller pins located on each side of the oven door frame (See [Figure 10](#)). The hook of the hinge arms must be fully seated onto the roller pins.
3. Fully open the oven door, horizontal with floor (See [Figure 7](#)).
4. Push the door hinge locks up toward and into the oven frame on both left and right oven door hinges to the locked position ([Figure 8](#)).
5. Close the oven door.

### Important:

Special Door Care Instructions - Most oven doors contain glass that can break. Do not close the oven door until all the oven racks are fully in place. Do not hit the glass with pots, pans, or any other object. Scratching, hitting, jarring, or stressing the glass may weaken its structure causing an increased risk of breakage at a later time.

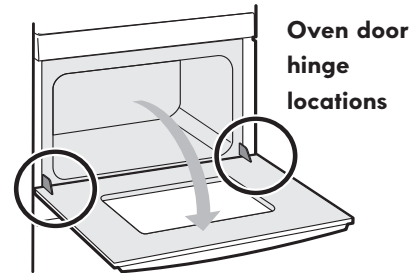

Figure 7: Door hinge location

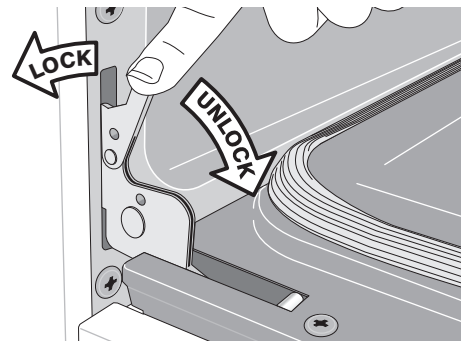

Figure 8: Door hinge locks

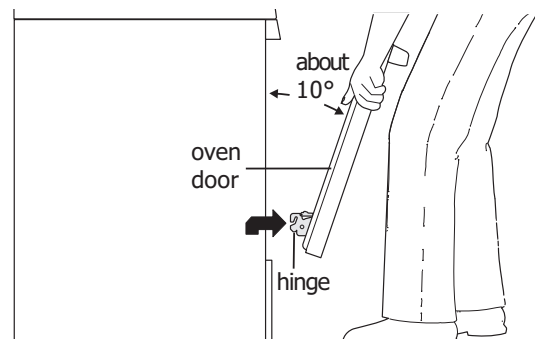

Figure 9: Holding door for removal

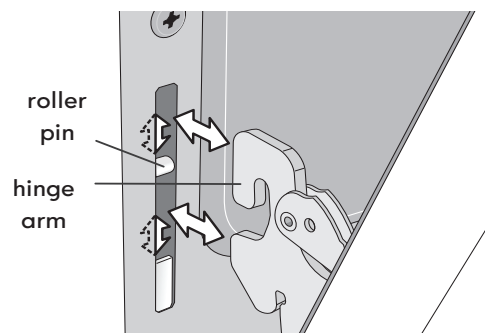

Figure 10: Location of hinge arm and roller pin

## Replacing the oven light

**⚠ CAUTION** Be sure the oven is unplugged and all parts are cool before replacing oven light.

The interior oven lights are located at the rear of the oven cavity and are covered with a glass shield. The glass shield must be in place whenever the oven is in use (See [Figure 11](#)).

### To replace the oven interior light bulb:

#### Important note:

Do not allow your fingers to touch the new bulb when replacing. This will shorten the life of the bulb. Use a paper towel or cotton glove while handling the new bulb when installing.

1. Turn electrical power off at the main source or unplug the appliance.
2. Remove interior oven light shield by turning a quarter turn counter-clockwise.
3. Replace bulb with a new T-4 type Halogen 25 watt appliance bulb.
4. Replace glass oven light shield by rotating clockwise.
5. Turn power back on again at the main source (or plug the appliance back in).
6. Be sure to reset the time of day on the clock.

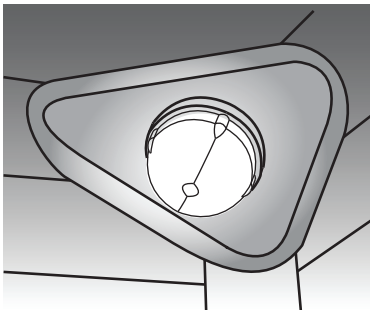

Figure 11: Wall oven Halogen light





# Before You Call

## Oven Baking

For best cooking results, heat the oven before baking cookies, breads, cakes, pies or pastries, etc. There is no need to preheat the oven for roasting meat or baking casseroles.

The cooking times and temperatures needed to bake a product may vary slightly from your previously owned appliance.

### Baking Problems and Solutions

Baking Problems	Causes	Corrections
Cookies and biscuits burn on the bottom. 	<ul style="list-style-type: none"> <li>• Cookies and biscuits put into oven before the preheating time is completed.</li> <li>• Oven rack is overcrowded.</li> <li>• Dark pans absorb heat too fast.</li> </ul>	<ul style="list-style-type: none"> <li>• Allow oven to preheat to desired temperature before placing food in oven.</li> <li>• Choose pan sizes that will permit 2" to 4" of air space (5.1 cm or 10.2 cm) on all sides when placed in the oven.</li> <li>• Use a medium weight baking sheet.</li> </ul>
Cakes too dark on top or bottom 	<ul style="list-style-type: none"> <li>• Cakes put in oven before preheating time is completed.</li> <li>• Rack position too high or too low.</li> <li>• Oven too hot.</li> </ul>	<ul style="list-style-type: none"> <li>• Allow oven to preheat to the selected temperature before placing food in the oven.</li> <li>• Use proper rack position for baking needs.</li> <li>• Set oven temperature 25°F/12°C lower than recommended.</li> </ul>
Cakes not done in center 	<ul style="list-style-type: none"> <li>• Oven too hot.</li> <li>• Incorrect pan size.</li> <li>• Pan not centered in oven.</li> </ul>	<ul style="list-style-type: none"> <li>• Set oven temperature 25°F/12°C lower than recommended.</li> <li>• Use pan size suggested in recipe.</li> <li>• Use proper rack position and place pan so there is 5.1 cm to 10.2 cm (2" to 4") of space on all sides of pan.</li> </ul>
Cakes not level. 	<ul style="list-style-type: none"> <li>• Oven not level.</li> <li>• Pan too close to oven wall or rack overcrowded.</li> <li>• Pan warped.</li> </ul>	<ul style="list-style-type: none"> <li>• Place a marked glass measuring cup filled with water on the center of the oven rack. If the water level is uneven, refer to the installation instructions for leveling the oven.</li> <li>• Be sure to allow 5.1 cm to 10.2 cm (2" to 4") of clearance on all sides of each pan in the oven.</li> <li>• Do not use pans that are dented or warped.</li> </ul>
Foods not done when cooking time is over. 	<ul style="list-style-type: none"> <li>• Oven too cool.</li> <li>• Oven overcrowded.</li> <li>• Oven door opened too frequently.</li> </ul>	<ul style="list-style-type: none"> <li>• Set oven temperature 25°F/12°C higher than suggested and bake for the recommended time.</li> <li>• Be sure to remove all pans from the oven except the ones to be used for baking.</li> <li>• Open oven door only after shortest recommended baking time.</li> </ul>

## Before You Call

### Solutions to Common Problems

Before you call for service, review the following list. It may save you time and expense. Possible solutions are provided with the problem listed:

Problem	Solution
Poor baking results	<p>Many factors effect baking results. Use proper oven rack position. Center food in the oven and space pans to allow air to circulate. Preheat oven to the set temperature before placing food in the oven. Try adjusting the recipe's recommended temperature or baking time. See <a href="#">"Adjusting Oven Temperature"</a> on <a href="#">page 11</a> if you feel the oven is too hot or cold.</p> <p>If your oven is cooking poorly, or self clean is performing badly, perform the following check: Press Broil; Press UP button: HI should be on the display. Place your hand near the handle on the oven door. Between the door and the control panel you should feel a rush of air on your hand. If so, your unit is functioning properly and you have had a Power Failure in your home. If no air stream is present, call a service technician to replace your cooling fan.</p>
Oven does not operate.	<p>The time of day is not set. The oven clock must first be set in order to operate the oven.</p> <p>Be sure oven controls are set properly. See <a href="#">"Setting the Clock"</a> on <a href="#">page 9</a> and review instructions for the desired cooking function in this manual.</p> <p>Service wiring is not complete.</p>
Oven light does not work.	Be sure the oven light is secure in the socket. See <a href="#">"Replacing the oven light"</a> on <a href="#">page 20</a> .
Flames inside oven or smoking from oven vent.	Excessive spills in oven. Grease or food spilled onto oven bottom or oven cavity. Wipe up excessive spills before starting oven. If flames or excessive smoke are present when using broil, see <a href="#">"Setting Broil"</a> on <a href="#">page 14</a> .
Self clean does not work.	Oven control not set properly. Review <a href="#">"Self-Cleaning Operation"</a> on <a href="#">page 16</a> .
Oven racks discolored or do not slide easily.	Oven racks left in oven cavity during self clean. Always remove oven racks from oven cavity before starting a self-clean cycle. Clean using a mild abrasive cleaner following manufacturer's instructions. Rinse with clean water, dry, and replace in oven.
Oven smokes excessively when broiling.	<p>Incorrect setting. Follow broiling instructions in <a href="#">"Setting Broil"</a> on <a href="#">page 14</a></p> <p>Meat too close to the broil element. Reposition broil rack to provide proper clearance between the meat and broil element. Remove excess fat from meat. Cut remaining fatty edges to prevent curling.</p> <p>Grease build up on oven surfaces. Regular cleaning is necessary when broiling frequently. Grease or food splatters will cause excessive smoking.</p>
Oven control panel beeps and displays any F or E code error.	Oven control has detected a fault or error condition. Press STOP to clear the error code. Try bake or broil function. If the F or E code error repeats, turn off power to appliance, wait 5 minutes and then repower appliance. Set clock with correct time of day. Try bake or broil function again. If fault recurs, press STOP to clear.
Soil not completely removed after self clean.	<p>Self Clean was interrupted. Review instructions in <a href="#">"Self-Cleaning Oven"</a> section on <a href="#">page 16</a>.</p> <p>Excessive spills on oven bottom. Clean before starting self clean.</p> <p>If your oven is cooking poorly, or self clean is performing badly, perform the following check: Press Broil; Press UP button: HI should be on the display. Place your hand near the handle on the oven door. Between the door and the control panel you should feel a rush of air on your hand. If so, your unit is functioning properly and you have had a Power Failure in your home. If no air stream is present, call a service technician to replace your cooling fan.</p>

## Master Protection Agreements

*Congratulations on making a smart purchase.* Your new Kenmore® product is designed and manufactured for years of dependable operation. But like all products, it may require preventive maintenance or repair from time to time. That's when having a Master Protection Agreement can save you money and aggravation.

The Master Protection Agreement also helps extend the life of your new product. Here's what the Agreement\* includes:

- ☑ **Parts and labor** needed to help keep products operating properly **under normal use**, not just defects. Our coverage goes **well beyond the product warranty**. No deductibles, no functional failure excluded from coverage – **real protection**.
- ☑ **Expert service** by a force of more than **10,000 authorized Sears service technicians**, which means someone you can trust will be working on your product.
- ☑ **Unlimited service calls and nationwide service**, as often as you want us, whenever you want us.
- ☑ **"No-lemon" guarantee** – replacement of your covered product if four or more product failures occur within twelve months.
- ☑ **Product replacement** if your covered product can't be fixed.
- ☑ **Annual Preventive Maintenance Check** at your request – no extra charge.
- ☑ **Fast help by phone** – we call it **Rapid Resolution** – phone support from a Sears representative on all products. Think of us as a "talking owner's manual".
- ☑ **Power surge protection** against electrical damage due to power fluctuations.
- ☑ **\$250 Food Loss Protection** annually for any food spoilage that is the result of mechanical failure of any covered refrigerator or freezer.
- ☑ **Rental reimbursement** if repair of your covered product takes longer than promised.
- ☑ **25% discount** off the regular price of any non-covered repair service and related installed parts.

Once you purchase the Agreement, a simple phone call is all that it takes for you to schedule service. You can call anytime day or night, or schedule a service appointment online.

The Master Protection Agreement is a risk free purchase. If you cancel for any reason during the product warranty period, we will provide a full refund. Or, a prorated refund anytime after the product warranty period expires. Purchase your Master Protection Agreement today!

**Some limitations and exclusions apply. For prices and additional information in the U.S.A. call 1-800-827-6655.**

**\* Coverage in Canada varies on some items. For full details call Sears Canada at 1-800-361-6665.**

### Sears Installation Service

*For Sears professional installation* of home appliances, garage door openers, water heaters, and other major home items, in the U.S.A. or Canada call **1-800-4-MY-HOME®**.

## Acuerdos maestros de protección

*Enhorabuena por haber hecho una compra inteligente.* Su nuevo producto Kenmore® está diseñado y fabricado para brindarle años de funcionamiento fiable. Pero, como cualquier producto, puede necesitar mantenimiento preventivo o reparaciones periódicas. Es por eso que tener un Acuerdo maestro de protección podría ahorrarle dinero y molestias.

El Acuerdo maestro de protección también sirve para prolongar la durabilidad de su nuevo producto. El acuerdo\* incluye lo siguiente:

- ☑ **Piezas y mano de obra** necesarias para contribuir a mantener el funcionamiento adecuado de los productos **utilizados en condiciones normales de uso**, no sólo en caso de defectos de los productos. Nuestra cobertura va **mucho más allá que la garantía del producto**. No se aplican deducibles ni exclusiones por fallas del funcionamiento: es decir, **verdadera protección**.
- ☑ **Servicio técnico por expertos** (más de **10000 técnicos autorizados de Sears**), lo cual significa que quien repare o realice el mantenimiento de su producto será un profesional de confianza.
- ☑ **Servicio técnico a escala nacional y número ilimitado de llamadas de solicitud de servicio técnico**: se puede poner en contacto con nosotros cuantas veces lo desee y cuando lo desee.
- ☑ **Garantía "sin sorpresas"**: se reemplaza el producto cubierto por el acuerdo si ocurren cuatro o más fallas del producto en un periodo de 12 meses.
- ☑ **Reemplazo del producto**: en caso de que no se pueda reparar el producto cubierto por el acuerdo.
- ☑ **Revisión anual preventiva de mantenimiento del producto**: puede solicitarla en cualquier momento, sin costo alguno.
- ☑ **Rápida asistencia telefónica**, la cual denominamos **Solución rápida**: es decir, asistencia telefónica a través de cualquiera de nuestros representantes de Sears, sobre cualquiera de nuestros productos. Piense en nosotros como en un "manual parlante del usuario".
- ☑ **Protección contra fallas eléctricas**, contra daños debidos a fluctuaciones de la corriente eléctrica.
- ☑ **\$250 al año para cubrir cualquier posible deterioro de alimentos** que haya tenido que desechar debido a una falla mecánica de cualquiera de nuestros refrigeradores o congeladores cubiertos por este acuerdo.
- ☑ **Devolución de gastos de alquiler de electrodomésticos** si la reparación de su producto asegurado toma más que el tiempo prometido.
- ☑ **25% de descuento** aplicable tanto a los costos del servicio de reparación, como de las piezas instaladas relacionadas que no hayan quedado cubiertos por este acuerdo.

Una vez que haya realizado el pago de este acuerdo, bastará una simple llamada telefónica para concertar una visita de servicio. Puede llamar a cualquier hora del día o de la noche, o bien concertar una visita de servicio por Internet.

La adquisición del Acuerdo maestro de protección es una inversión exenta de riesgos. Si por cualquier motivo decide cancelar dicho acuerdo durante el periodo de garantía del producto, le haremos un reintegro total del valor. O bien un importe proporcional si cancela el acuerdo en cualquier otro momento posterior al vencimiento del periodo de garantía del producto. ¡Adquiera hoy mismo su Acuerdo maestro de protección!

**Algunas limitaciones y exclusiones podrían aplicarse. Para solicitar precios e información adicional, llame al 1-800-827-6655 (en los EE.UU.).**

**\* La cobertura en Canadá varía en el caso de algunos artículos. Para obtener detalles completos al respecto, llame al 1-800-361-6665 de Sears de Canadá.**

### Servicio de instalación de Sears

*Para solicitar la instalación por profesionales de Sears* de electrodomésticos, abridores de puertas de garaje, calentadores de agua y otros artículos de uso prioritario en el hogar, **llame al 1-800-4-MY-HOME** en los EE.UU. o Canadá.



# Get it fixed, at your home or ours!

## Your Home

For troubleshooting, product manuals and expert advice:



[www.managemylife.com](http://www.managemylife.com)

---

For repair – **in your home** – of **all** major brand appliances, lawn and garden equipment, or heating and cooling systems, **no matter who made it, no matter who sold it!**

For the replacement parts, accessories and owner's manuals that you need to do-it-yourself.

For Sears professional installation of home appliances and items like garage door openers and water heaters.

**1-800-4-MY-HOME<sup>®</sup>** (1-800-469-4663)

Call anytime, day or night (U.S.A. and Canada)

[www.sears.com](http://www.sears.com)    [www.sears.ca](http://www.sears.ca)

---

## Our Home

For repair of carry-in items like vacuums, lawn equipment, and electronics, call anytime for the location of your nearest

**Sears Parts & Repair Service Center**

**1-800-488-1222** (U.S.A.)

[www.sears.com](http://www.sears.com)

**1-800-469-4663** (Canada)

[www.sears.ca](http://www.sears.ca)

---

To purchase a protection agreement on a product serviced by Sears:

**1-800-827-6655** (U.S.A.)

**1-800-361-6665** (Canada)

---

Para pedir servicio de reparación a domicilio, y para ordenar piezas:

**1-888-SU-HOGAR<sup>®</sup>**

(1-888-784-6427)

[www.sears.com](http://www.sears.com)

Au Canada pour service en français:

**1-800-LE-FOYER<sup>MC</sup>**

(1-800-533-6937)

[www.sears.ca](http://www.sears.ca)

sears

® Registered Trademark / <sup>TM</sup> Trademark of KCD IP, LLC in the United States, or Sears Brands, LLC in other countries

® Marca Registrada / <sup>TM</sup> Marca de Fábrica de KCD IP, LLC en Estados Unidos, o Sears Brands, LLC in otros países

<sup>MC</sup> Marque de commerce / <sup>MD</sup> Marque déposée de Sears Brands, LLC



## Free Manuals Download Website

<http://myh66.com>

<http://usermanuals.us>

<http://www.somanuals.com>

<http://www.4manuals.cc>

<http://www.manual-lib.com>

<http://www.404manual.com>

<http://www.luxmanual.com>

<http://aubethermostatmanual.com>

Golf course search by state

<http://golfingnear.com>

Email search by domain

<http://emailbydomain.com>

Auto manuals search

<http://auto.somanuals.com>

TV manuals search

<http://tv.somanuals.com>