



# Electric Range

Use & Care Guide

# Estufa eléctrica

Guía para el Uso y Cuidado

Models, Modelos **790.9090\***, 9091\*, 9400\*, 9411\*, 9412\*, 9413\*  
\* = color number, número de color

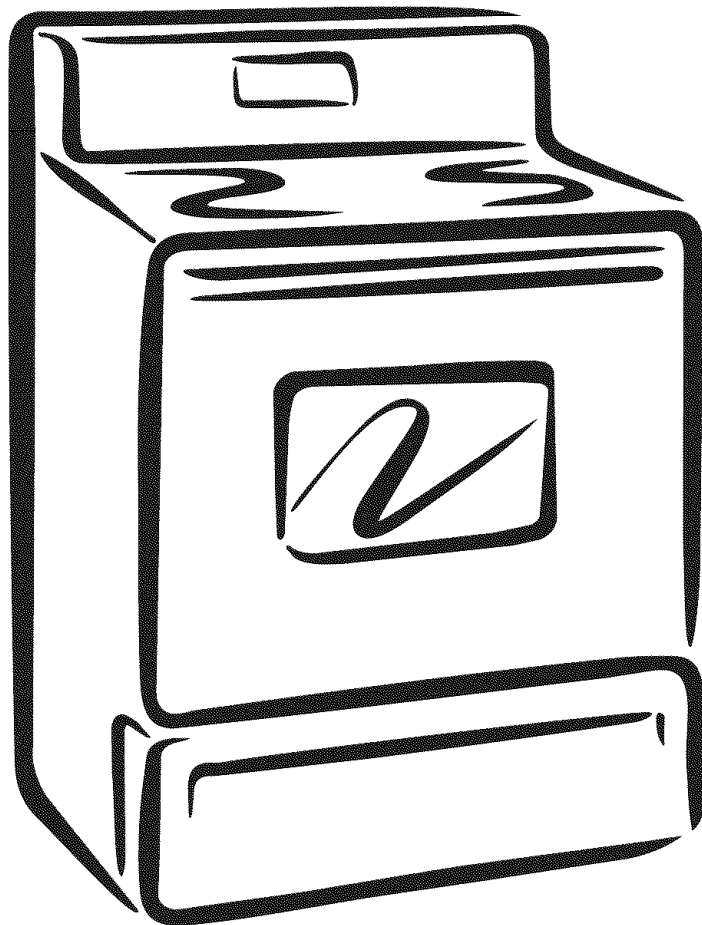

ENGLISH

ESPAÑOL

## Table of Contents

Free-Standing Range Warranty .....	2
Product Record .....	2
<b>IMPORTANT SAFETY INSTRUCTIONS</b> .....	3-4
Protection Agreements .....	5
Range Features .....	6
Before Setting Oven Controls .....	7-8
Setting Surface Controls .....	8
Surface Cooking .....	9
Oven Control Functions .....	10
Setting Oven Controls .....	11-13
Select Self Cleaning .....	14-15
General Care & Cleaning .....	16-19
Adjusting Your Oven Temperature .....	19
Before You Make a Service Call .....	20-21
Sears Service .....	Back Page
Español .....	23-44

## Product Record

In this space below, record the date of purchase, model and serial number of your product. You will find the model and serial number printed on an identification plate. The serial plate is located on the right side of the oven front frame in the storage or warmer drawer compartment. **See bottom of this page** for the serial plate location.

Model No. **790.** \_\_\_\_\_

Serial No. \_\_\_\_\_

Date of Purchase \_\_\_\_\_

Save these instructions and your sales receipt for future reference.

## Kenmore Appliance Warranty

### One Year Limited Warranty

When installed, operated and maintained according to all instructions supplied with the product, if this appliance fails due to a defect in material or workmanship within one year from the date of purchase, call **1-800-4-MY-HOME**® to arrange for free repair. If this appliance is used for other than private family purposes, this warranty applies for only 90 days from the date of purchase.

#### **This warranty covers only defects in material and workmanship. Sears will NOT pay for:**

1. Expendable items that can wear out from normal use, including but not limited to filters, belts, light bulbs, and bags.
2. A service technician to instruct the user in correct product installation, operation or maintenance.
3. A service technician to clean or maintain this product.
4. Damage to or failure of this product if it is not installed, operated or maintained according to all instructions supplied with the product.
5. Damage to or failure of this product resulting from accident, abuse, misuse or use for other than its intended purpose.
6. Damage to or failure of this product caused by the use of detergents, cleaners, chemicals or utensils other than those recommended in all instructions supplied with the product.
7. Damage to or failure of parts or systems resulting from unauthorized modifications made to this product.

#### **Disclaimer of implied warranties; limitation of remedies**

Customer's sole and exclusive remedy under this limited warranty shall be product repair as provided herein. Implied warranties, including warranties of merchantability or fitness for a particular purpose, are limited to one year or the shortest period allowed by law. Sears shall not be liable for incidental or consequential damages. Some states and provinces do not allow the exclusion or limitation of incidental or consequential damages, or limitations on the duration of implied warranties of merchantability or fitness, so these exclusions or limitation may not apply to you.

This warranty applies only while this appliance is used in the United States and Canada.

This warranty gives you specific legal rights, and you may also have other rights which vary from state to state.

**Sears, Roebuck and Co., Dept. 817WA, Hoffman Estates, IL 60179**

**Sears Canada Inc., Toronto, Ontario, Canada M5B 2B8**

## Serial Plate Location

You will find the model and serial number printed on the serial plate. The serial plate is located on the right side of the oven front frame in the storage or warmer drawer compartment.

Please see the illustration for exact location.

Remember to record the serial number for future reference (See top of page under Product Record).

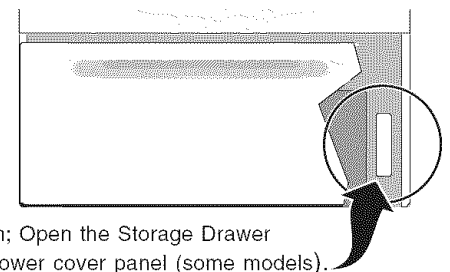

Serial plate location; Open the Storage Drawer (some models) or lower cover panel (some models).

# Important Safety Instructions

**Read all instructions before using this appliance. Save these instructions for future reference.**

This manual contains important safety symbols and instructions. Please pay attention to these symbols and follow all instructions given.

**⚠ WARNING** This symbol will help alert you to situations that may cause serious bodily harm, death or property damage.

**⚠ CAUTION** This symbol will help alert you to situations that may cause bodily injury or property damage.

- **Remove all tape and packaging before using the range.** Destroy the carton and plastic bags after unpacking the range. Never allow children to play with packaging material.
- **Proper Installation—Be sure your appliance is properly installed and grounded by a qualified technician in accordance with the National Electrical Code ANSI/NFPA No. 70 latest edition and local electrical code requirements.** Install only per installation instructions provided in the literature package for this range. Ask your dealer to recommend a qualified technician and an authorized repair service. Know how to disconnect the power to the range at the circuit breaker or fuse box in case of an emergency.
- **User servicing—Do not repair or replace any part of the appliance unless specifically recommended in the manuals.** All other servicing should be done only by a qualified technician. This may reduce the risk of personal injury and damage to the range.
- **Never modify or alter the construction of a range by removing leveling legs, panels, wire covers, anti-tip brackets/screws, or any other part of the product.**

## ⚠ WARNING

- All ranges can tip.
- Injury to persons could result.
- Install anti-tip device packed with range.
- See Installation Instructions.



**⚠ WARNING** To reduce the risk of tipping, the range must be secured by properly installed anti-tip bracket provided with the range. To check if the bracket is installed properly, visually check that rear leveling leg is inserted into and fully secured by the anti-tip bracket by removing lower panel or storage drawer. For models with a warmer drawer, grasp the top rear edge of the range and carefully attempt to tilt it forward. Refer to the installation instructions for proper anti-tip bracket installation.



**⚠ WARNING** Stepping, leaning or sitting on the doors or drawers of this range can result in serious injuries and also cause damage to the range. Do not allow children to climb or play around the range. The weight of a child on an open door may cause the range to tip, resulting in serious burns or other injury.

**⚠ CAUTION** Do not store items of interest to children in the cabinets above a range or on the backguard of a range. Children climbing on the range to reach items could be seriously injured.

**⚠ WARNING** Do not use the oven or warmer drawer (if equipped) for storage.

**⚠ WARNING** Never Use Your Appliance for Warming or Heating the Room.

- **Storage in or on Appliance—Flammable materials should not be stored in an oven, warmer drawer, near surface units or in the storage drawer.** This includes paper, plastic and cloth items, such as cookbooks, plasticware and towels, as well as flammable liquids. Do not store explosives, such as aerosol cans, on or near the range.
- **Do Not Leave Children Alone—Children should not be left alone or unattended in the area where appliance is in use.** They should never be allowed to sit or stand on any part of the appliance.
- **DO NOT TOUCH SURFACE UNITS, AREAS NEAR THESE UNITS, HEATING ELEMENTS OR INTERIOR SURFACES OF THE OVEN.** Both surface units and oven heating elements may be hot even though they are dark in color. Areas near surface units may become hot enough to cause burns. During and after use, do not touch, or let clothing or other flammable materials touch these areas until they have had sufficient time to cool. Among these areas are the cook top, surfaces facing the cook top, the oven vent openings and surfaces near these openings, oven door and window.
- **Wear Proper Apparel—Loose-fitting or hanging garments should never be worn while using the appliance.** Do not let clothing or other flammable materials contact hot surfaces.
- **Do Not Use Water or Flour on Grease Fires—Smother the fire with a pan lid, or use baking soda, a dry chemical or foam-type extinguisher.**
- **When heating fat or grease, watch it closely.** Fat or grease may catch fire if allowed to become too hot.
- **Use Only Dry Potholders - Moist or damp potholders on hot surfaces may result in burns from steam.** Do not let potholders touch hot heating elements. Do not use a towel or other bulky cloth instead of a potholder.
- **Do Not Heat Unopened Food Containers - Buildup of pressure may cause container to burst and result in injury.**
- **Remove the oven door from any unused range if it is to be stored or discarded.**

**IMPORTANT—Do not attempt to operate the range during a power failure.** If the power fails, always turn off the range. If the range is not turned off and the power resumes, the range will begin to operate again. Once the power resumes, reset the clock and oven function.

# Important Safety Instructions

## IMPORTANT INSTRUCTIONS FOR USING YOUR COOKTOP

- **Know which knob controls each surface heating unit.** Place a pan of food on the unit before turning it on, and turn the unit off before removing the pan.
- **Use Proper Pan Size**—This appliance is equipped with one or more surface units of different sizes. Select utensils having flat bottoms large enough to cover the surface unit heating element. The use of undersized utensils will expose a portion of the heating element to direct contact and may result in ignition of clothing. Proper relationship of utensil to element will also improve efficiency.
- **Utensil Handles Should Be Turned Inward and Not Extend Over Adjacent Surface Elements**—To reduce the risk of burns, ignition of flammable materials, and spillage due to unintentional contact with the utensil, the handle of the utensil should be positioned so that it is turned inward, and does not extend over adjacent surface units.
- **Never Leave Surface Elements Unattended at High Heat Settings**—Boilovers cause smoking and greasy spillovers that may ignite, or a pan that has boiled dry may melt.
- **Do Not Immerse or Soak Removable Heating Elements**—Heating elements should never be immersed in water. Heating elements clean themselves during normal operation.
- **Glazed Cooking Utensils**—Only certain types of glass, glass/ceramic, ceramic, earthenware, or other glazed utensils are suitable for cook top service without breaking due to the sudden change in temperature. Check the manufacturer's recommendations for cook top use.
- **When flaming foods under a ventilating hood, turn the fan on.**

## SELF CLEANING OVENS

- **Clean in the self-cleaning cycle only the parts listed in this Use & Care Manual.** Before self cleaning the oven, remove the broiler pan and any utensils or foods from the oven.
- **Do Not Use Oven Cleaners**—No commercial oven cleaner or oven liner protective coating of any kind should be used in or around any part of the oven.
- **Do Not Clean Door Gasket**—The door gasket is essential for a good seal. Care should be taken not to rub, damage or move the gasket.
- The health of some birds is extremely sensitive to the fumes given off during the self-cleaning cycle of any range. Move birds to another well-ventilated room.

## IMPORTANT INSTRUCTIONS FOR CLEANING YOUR RANGE

- **Clean the range regularly to keep all parts free of grease that could catch fire.** Pay particular attention to the area underneath each surface element. Do not allow grease to accumulate.
- **Kitchen cleaners and aerosols**—Always follow the manufacturer's recommended directions for use. Be aware that excess residue from cleaners and aerosols may ignite causing damage and injury.
- **Clean Ventilating Hoods Frequently**—Grease should not be allowed to accumulate on the hood or filter. Follow manufacturer's instructions for cleaning.

## COIL COOK TOP MODELS

- **Make Sure Reflector Pans or Drip Bowls Are in Place**—Absence of these pans or bowls during cooking may subject wiring or components underneath to damage.
- **Protective Liners**—Do not use aluminum foil to line surface unit drip bowls, or reflector pans. Only use aluminum foil as recommended in this manual. Improper installation of these liners may result in risk of electric shock, or fire. Improper installation of these liners may result in risk of electric shock, or fire.

---

## Important Safety Notice

The California Safe Drinking Water and Toxic Enforcement Act requires the Governor of California to publish a list of substances known to the state to cause cancer, birth defects or other reproductive harm, and requires businesses to warn customers of potential exposure to such substances.

# PROTECTION AGREEMENTS

## In the U.S.A.

### Master Protection Agreements

Congratulations on making a smart purchase. Your new Kenmore® product is designed and manufactured for years of dependable operation. But like all products, it may require preventive maintenance or repair from time to time. That's when having a Master Protection Agreement can save you money and aggravation.

*Purchase a Master Protection Agreement now and protect yourself from unexpected hassle and expense.*

The Master Protection Agreement also helps extend the life of your new product. Here's what's included in the Agreement:

- ✓ **Expert service** by our 12,000 professional repair specialists.
- ✓ **Unlimited service and no charge** for parts and labor on all covered repairs.
- ✓ **"No-lemon" guarantee** – replacement of your covered product if four or more product failures occur within twelve months.
- ✓ **Product replacement** if your covered product can't be fixed.
- ✓ **Annual Preventive Maintenance Check** at your request – no extra charge.
- ✓ **Fast help by phone** – phone support from a Sears technician on products requiring in-home repair, plus convenient repair scheduling.
- ✓ **Power surge protection** against electrical damage due to power fluctuations.
- ✓ **Rental reimbursement** if repair of your covered product takes longer than promised.

Once you purchase the Agreement, a simple phone call is all that it takes for you to schedule service. You can call anytime day or night, or schedule a service appointment online.

Sears has over 12,000 professional repair specialists, who have access to over 4.5 million quality parts and accessories. That's the kind of professionalism you can count on to help prolong the life of your new purchase for years to come. Purchase your Master Protection Agreement today!

**Some limitations and exclusions apply.  
For prices and additional information call  
1-800-827-6655.**

### Sears Installation Service

For Sears professional installation of home appliances, garage door openers, water heaters, and other major home items, in the U.S.A. call **1-800-4-MY-HOME®**.

# ACUERDOS DE PROTECCIÓN

## En los EE.UU.

### Acuerdos maestros de protección

Lo felicitamos por haber hecho una compra inteligente. Su nuevo producto Kenmore® fue diseñado y fabricado para ofrecer muchos años de servicio confiable. Sin embargo, como todo producto, el mismo podría requerir mantenimiento preventivo o reparaciones ocasionales. Es por eso que el tener un Acuerdo maestro de protección podría ahorrarle dinero y molestias.

*Adquiera ya un Acuerdo maestro de protección y protéjase de gastos y frustraciones inesperados.*

El Acuerdo maestro de protección también ayuda a extender la vida de su producto nuevo. El Acuerdo incluye lo siguiente:

- ✓ **Servicio profesional** por nuestros 12.000 profesionales especialistas en reparación.
- ✓ **Servicio ilimitado sin cargos adicionales** por piezas y servicio en todas las reparaciones cubiertas.
- ✓ **Garantía de "no-limón"** – reemplaza su producto cubierto si ocurren cuatro o más desperfectos en los primeros doce meses.
- ✓ **Reemplazo del producto** si el mismo no puede ser reparado.
- ✓ **Verificación de mantenimiento preventivo anual** a su petición y sin cargos adicionales.
- ✓ **Pronta ayuda por teléfono** – apoyo por teléfono por un técnico de Sears en los productos que requieran reparación en casa, además de la conveniencia de hacer una cita para la reparación.
- ✓ **Protección contra picos de energía** o daños eléctricos causados por fluctuaciones de la corriente eléctrica.
- ✓ **Reembolso del alquiler** si la reparación de su producto cubierto toma más del tiempo prometido.

Una vez que adquiera este Acuerdo, una simple llamada telefónica es todo lo que necesita para hacer una cita de servicio. Usted puede llamar a cualquier hora del día o de la noche para programar una cita de servicio por Internet.

Sears cuenta con más de 12.000 profesionales especialistas de reparación con acceso a más de 4,5 millones de piezas y accesorios de calidad. Esa es la clase de profesionalismo con la que puede contar para extender la vida útil de su nueva adquisición por muchos años. ¡Adquiera su Acuerdo maestro de protección hoy!

**Algunas limitaciones y exclusiones podrían aplicarse.  
Para precios e información adicional, llame al  
1-800-827-6655.**

### Servicio de instalación Sears

Para una instalación profesional de Sears en electrodomésticos, abridores de puertas de garaje, calentadores de agua y otros artículos mayores del hogar, llame al **1-888-SU-HOGAR®**.

REV. 030509

# Range Features

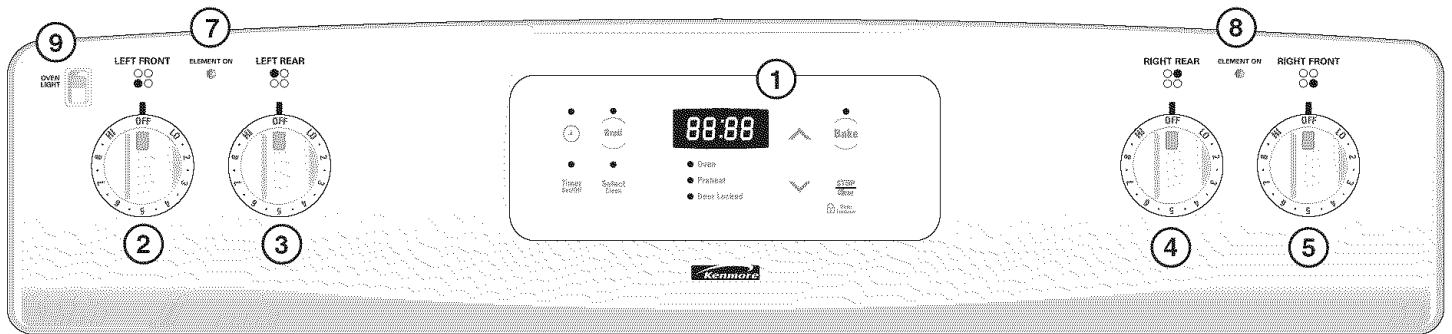

## Your Electric Range Features Include:

1. Electronic Oven Control with Kitchen Timer.
2. Single Element Control.
3. Single Element Control.
4. Single Element Control.
5. Single Element Control.
6. (not shown)
7. "ELEMENT ON" Indicator Light.
8. "ELEMENT ON" Indicator Light.
9. Manual Oven Light Switch (some models).
10. Automatic Oven Door Light Switch (some models).
11. Oven Interior Light with Shield (some models).
12. Self-Cleaning Oven interior.
13. Self-Clean Door Latch.
14. Adjustable Oven Rack(s).
15. Large 1 piece Oven Door Handle.
16. Full width Oven Door (style vary with model).
17. Storage Drawer with Drawer Handle (some models) or lower cover panel (some models).
18. Easy to clean upswept Coil Element Cooktop.
19. 6" Single Elements.
20. 8" Single Elements.
21. Removable Element Drip Bowls.
22. Broil Pan (some models).
23. Broil Pan Insert (some models).
24. Leveling Legs and Anti-tip Bracket (included).

**NOTE:** The features of your range may vary according to model type & color.

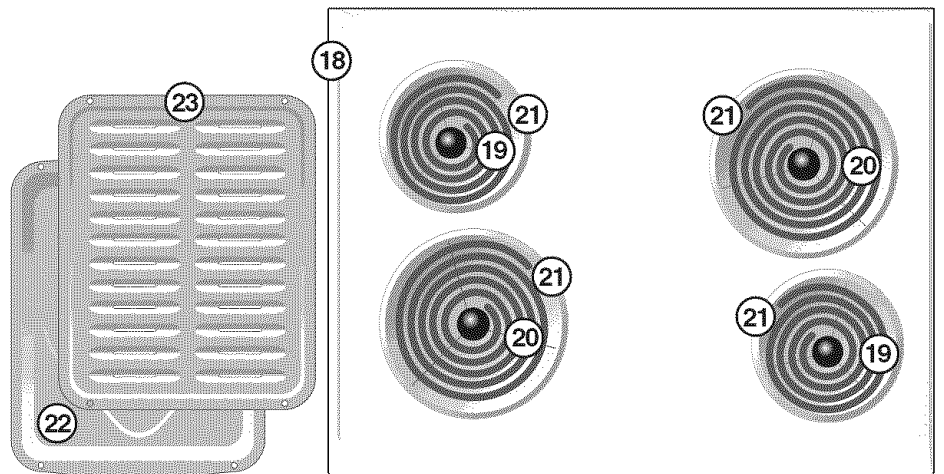
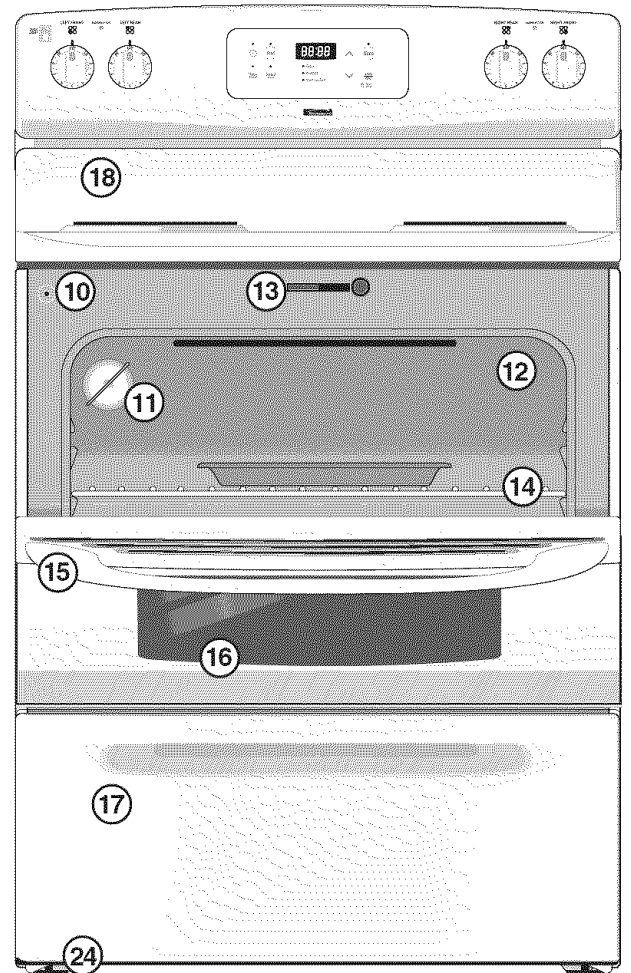

# Before Setting Oven Controls

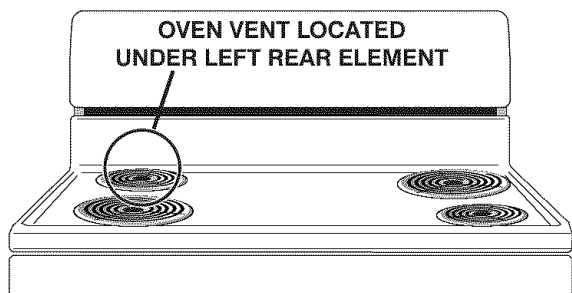

Fig. 1

## Oven Vent Location

The oven vent is located **under the left rear surface element** (See Fig. 1). When the oven is on, warm air passes through the vent. This venting is necessary for proper air circulation in the oven and good baking results. **DO NOT BLOCK OVEN VENT.**

## Removing & Replacing Oven Racks

**To remove**, pull the rack forward until it stops. Lift up front of rack and slide out. **To replace**, fit the rack onto the guides on the oven walls. Tilt the front of the rack upward and slide the rack back into place.

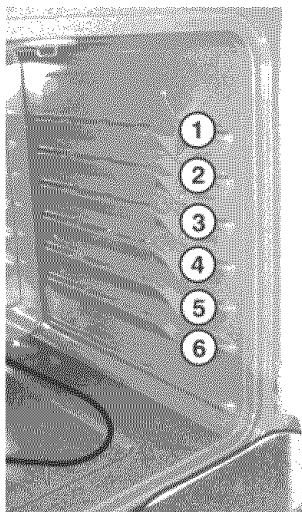

Oven with visible Bake Element - Fig. 2

## Arranging Oven Racks

**ALWAYS ARRANGE OVEN RACKS WHEN THE OVEN IS COOL (PRIOR TO OPERATING THE OVEN).** Always use oven mitts when using the oven.

For models with a visible Bake Element (Refer to Fig. 2)

For models with a hidden Bake Element\* (Refer to Fig. 3)

### Recommended Rack Positions for Broiling, Baking & Roasting:

Food	Rack Position	Rack Position*
Broiling hamburgers & steaks	1	1
Broiling meats, chicken or fish	1, 2 or 3	1, 2, or 3
Cookies, cakes, pies, biscuits & Muffins	3 or 4	3 or 4
Frozen pies, angel food cake, yeast, bread, casseroles, small cuts of meat or poultry	5 or 6	6
Turkey, roast or ham	6	7

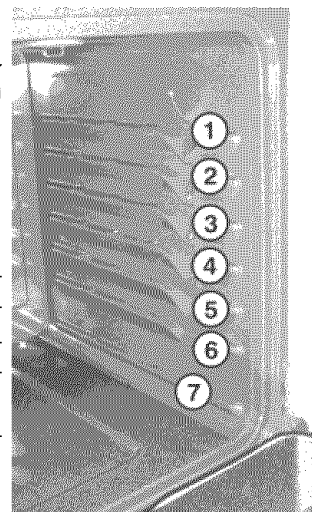

Oven with hidden Bake Element - Fig. 3\*

## Types of Oven Racks

Your range may be equipped with one or more of the oven rack types shown; **Flat Rack**, **Handle Rack** and **Offset Rack**. To maximize cooking space the Offset rack can be used in the lowest rack position to roast large cuts of meat and poultry.

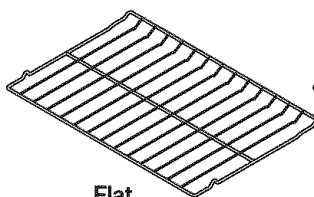

Flat Oven Rack

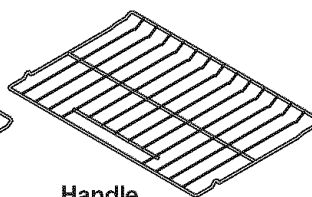

Handle Oven Rack

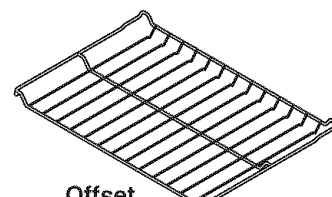

Offset Oven Rack

## Baking Layer Cakes with 1 or 2 Oven Racks

For best results when baking cakes using 2 oven racks, place cookware on rack positions 2 & 5 (for models with a visible bake element). For models with a hidden bake element place oven racks in positions 3 (Flat rack) & 6 with the Offset rack if equipped (Refer to Fig. 4).

For best results when using a single oven rack, place cookware on rack position 4 (for all models - Refer to Fig. 5).

## Air Circulation in the Oven

For best air circulation and baking results allow 2-4" (5-10 cm) around the cookware for proper air circulation and be sure pans and cookware do not touch each other, the oven door, sides or back of the oven cavity. The hot air must be able to circulate around the pans and cookware in the oven for even heat to reach around the food.

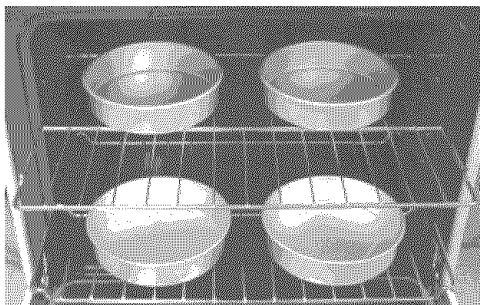

Fig. 4

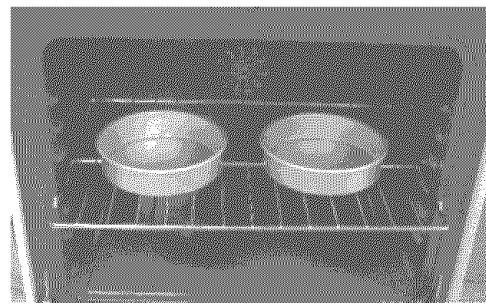

Fig. 5

# Before Setting Oven Controls (cont'd)

ELEMENT ON



## ELEMENT ON Indicator Lights

Your range is equipped with surface control indicator lights that will glow on your range—the **ELEMENT ON** indicator lights (See illustration at left).

The **ELEMENT ON** is located on the control panel and will glow when a surface element is turned ON. A quick glance at these indicator lights after cooking is an easy check to be sure ALL surface controls are turned OFF.

## Setting Surface Controls

To Operate Surface Elements (all models)

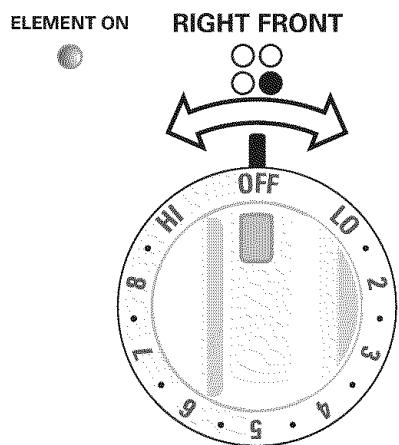

### To Operate the Surface Elements:

1. Place cooking utensil on the surface element.
2. Push in and turn the surface control knob either direction to the desired setting. Start most cooking operations on a higher setting and then turn to a lower setting to finish cooking. The control knobs do not have to be set exactly on a particular setting. Use the settings as a guide and adjust the control knob as needed.
3. When cooking is completed, turn the surface element OFF before removing the pan. Note: The surface “**ELEMENT ON**” indicator light(s) will glow when one or more elements are turned on. A quick glance at these indicator light(s) when cooking is finished is an easy check to be sure all surface elements are turned off. See chart below for recommended control settings for different types of foods.

The suggested settings found in the table below are based on cooking in medium-weight aluminum pans with lids. Settings may vary when using other types of pans.

### STANDARD SETTING FOR SURFACE ELEMENTS

Setting	Type of Cooking
HIGH (HI - 9)	Start most foods, bring water to a boil, pan broiling
MEDIUM HIGH (7 - 8)	Continue a rapid boil, fry, deep fat fry
MEDIUM (5 - 6)	Maintain a slow boil, thicken sauces and gravies, steam vegetables
MEDIUM LOW (2 - 4)	Keep foods cooking, poach, stew
LOW (LO - 1)	Keep warm, melt, simmer

### SIMMER SELECT SURFACE ELEMENT

Max. Simmer (4)	Larger quantities of food, stews and soups
Min. Simmer (LO)	Smaller quantities of food, delicate foods, melting chocolate or butter



# Surface Cooking

## Using proper cookware

The size and type of cookware used will influence the setting needed for best cooking results. Cookware should have flat bottoms that make good contact with the entire surface heating element (See Fig. 1). Check for flatness by rotating a ruler across the bottom of the cookware (See Fig. 2).

## Cookware Material Types

The cookware material determines how evenly and quickly heat is transferred from the surface element to the pan bottom. The most popular materials available are:

**ALUMINUM** - Excellent heat conductor. Some types of food will cause it to darken (Anodized aluminum cookware resists staining & pitting). If aluminum pans slide across the ceramic cooktop, they may leave metal marks which will resemble scratches. Remove these marks immediately.

**COPPER** - Excellent heat conductor but discolors easily. May leave metal marks on ceramic glass (see Aluminum above).

**STAINLESS STEEL** - Slow heat conductor with uneven cooking results. Is durable, easy to clean and resists staining.

**CAST IRON** - A poor heat conductor however will retain heat very well. Cooks evenly once cooking temperature is reached. Not recommended for use on ceramic cooktops.

**PORCELAIN-ENAMEL on METAL** - Heating characteristics will vary depending on base material. Porcelain-enamel coating must be smooth to avoid scratching ceramic cooktops.

**GLASS** - Slow heat conductor. Not recommended for ceramic cooktop surfaces because it may scratch the glass.

## CORRECT

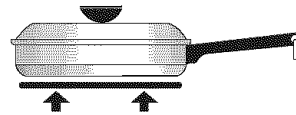

- Flat bottom and straight sides.
- Tight fitting lids.
- Weight of handle does not tilt pan. Pan is well balanced.
- Pan sizes match the amount of food to be prepared and the size of the surface element.
- Made of a material that conducts heat well.
- Easy to clean.
- Always match pot diameter to surface element diameter.

## INCORRECT

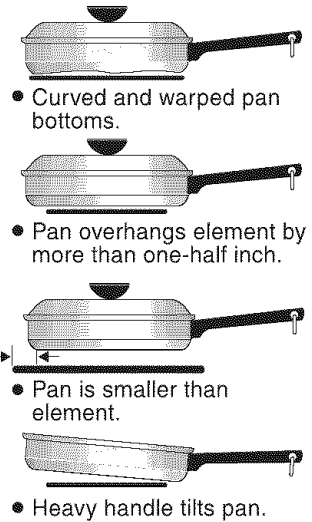

Fig. 1

Be sure to follow the recommendations for using proper cookware as illustrated in Figs. 1 & 2. For more information about the ceramic cooktop see "Cooktop Cleaning & Maintenance" in the **General Care & Cleaning** section.

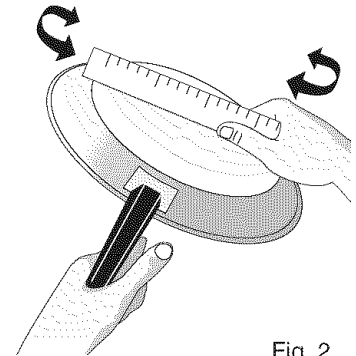

Fig. 2

# Oven Control Functions

**READ THE INSTRUCTIONS CAREFULLY BEFORE USING THE OVEN.** For satisfactory use of your oven, become familiar with the various pad functions of the oven as described below.



\*Note: The **OVEN** indicator light on the electronic display will turn ON and OFF when using the Bake feature and during preheat. This is normal and indicates that the oven is cycling to maintain the selected baking temperature. When the preheat indicator light turns OFF, your oven is ready.

## Temperature conversion

The electronic oven control is set to operate in °F (Fahrenheit) when shipped from the factory. The oven can be programmed for any temperature from 170°F to 550°F (77°C to 287°C).

**To change the temperature to °C (Celsius) or from °C to °F (control should not be in a Bake or Clean mode):**

1. Press **Broil**. "— —" appears in the display.
2. Press and hold the **▲** until "HI" appears in the display.
3. Press and hold **Broil** until °F or °C appears in the display.
4. Press the **▲** or **▼** to change °F to °C or °C to °F.
5. Press any control pad to return to normal operating mode.

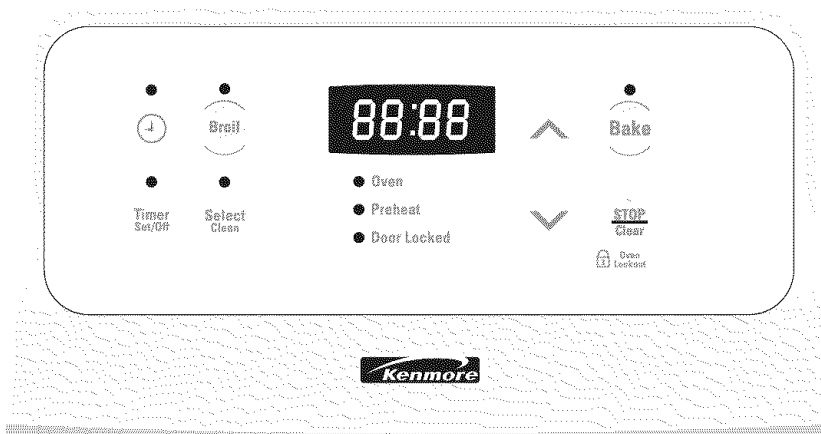

# Setting Oven Controls



**Note:** The time of day **must** first be set in order to operate the oven.





## To Set the Clock

When the range is first plugged in, or when the power supply to the range has been interrupted, the display will flash "12:00".

1. Press  once (do not hold pad down).
2. Within 5 seconds, press and hold the  or  until the correct time of day appears in the display.

**Note:** The clock cannot be changed during a Self-Clean cycle.



## To Set the Minute Timer:

1. Press .
2. Press the  to increase the time in one minute increments. Press and hold the  to increase the time in 10 minute increments. The timer can be set for any amount of time from 1 minute to 11 hours and 59 minutes.  
**Note:** If the  pad is pressed first, the timer will advance to 11 hours and 59 minutes.
3. The display shows the timer countdown in minutes until 1 minute remains. Then the display will countdown in seconds.
4. When the set time has run out, the timer will beep 3 times and will continue to beep 3 times every 60 seconds until  is pressed.



**Note:** The indicator light located above the  pad will glow while the minute timer is active.

**Note:** The minute timer does not start or stop cooking. It serves as an extra timer in the kitchen that will beep when the set time has run out. The minute timer can be used alone or during any of the other oven functions. When the minute timer is in use with any other function, the minute timer will be shown in the display. To view other functions, press the pad for that function.

## To Change the Minute Timer while it is in use:

While the timer is active and shows in the display, press and hold the  or  to increase or decrease the time.

**To Cancel the Minute Timer before the set time has run out:** Press .









**Note:** To turn the **time of day** display **OFF** or **ON** in the display press  and hold for 15 seconds (the control will beep once) and then release. This feature does not remove the set time of day from the memory of the control. When the display is turned OFF the time of day will re-appear for a few seconds any time the  pad is touched.

## Setting Oven Controls (cont'd)



### To Set or Change the Temperature for Baking

The oven can be programmed to bake at any temperature from 170°F to 550°F (77°C to 287°C).

#### To Set the Controls for Baking:

1. Press . "— — —" appears in the display.
2. Within 5 seconds, press the  or . The display will show "350°F (177°C)." By pressing and holding the  or , the temperature can then be adjusted in 5°F increments (1°C if the control is set to display Celsius).
3. As soon as the  or  pad is released, the oven will begin heating to the selected temperature. When the displayed temperature reaches the desired baking temperature, the preheat indicator light will turn OFF and the control will beep 3 times.
4. To cancel baking, press .



#### To Change the Oven Temperature after Baking has Started:

1. Press  and make sure the bake temperature is displayed.
2. Press the  or  pad to increase or decrease the set temperature.

### To Set Control for Continuous Bake or 12 Hour Energy Saving

The oven control has a built-in 12 Hour Energy Saving feature that will shut off the oven if the control is left on for more than 11 hours and 59 minutes. The oven can be programmed to override this feature for continuous baking.



#### To set control for continuous baking:

1. Press and hold  down for 5 seconds until tone is heard, " — — hr" will appear in display for continuous cooking. The current time of day will return to the display.
2. To cancel the Continuous Bake function, press  and hold for 5 seconds until tone is heard. "12hr" will appear in display indicating that the control has returned to the 12 Hour Energy Saving feature.

### To Set Control for Oven Lockout

The control can be programmed to lock the oven door and lockout the oven control pads.







#### To set Control for Oven Lockout feature:

1. Press  and hold for 3 seconds. "Loc" will appear in display, the "Door Locked" indicator light will flash and the motor driven door lock will begin to close automatically. **DO NOT open oven door** while the indicator light is flashing. Allow about 15 seconds for the oven door to lock. Once the oven door is locked, the current time of day will appear in the display.
2. To cancel the Oven Lockout feature, press  and hold for 3 seconds. The control will unlock the oven door and resume normal operation.

**Note: If any control pad is pressed while in the Oven Lockout mode, "Loc" will appear in the display until the control pad is released.**

# Setting Oven Controls (cont'd)

## To Set for Broiling:

1. Arrange the oven rack while oven is still cool. Position the rack as suggested in the **Broil Rack Position Table** below.
2. Press . " — — " will appear in display.
3. Press and hold the  or  until the desired broil setting level appears in the display. Press the  for **HI** broil or the  for **LO** broil. Most foods may be broiled at the **HI** broil setting. Select the **LO** broil setting to avoid excess browning or drying of foods that should be cooked to the well-done stage.
4. **For optimum browning, preheat broil element for 3 - 4 minutes before adding food.**
5. Place the insert on the broil pan, then place the food on the insert (See Fig. 1; some models). **DO NOT** use the broil pan without the insert or cover the insert with **aluminum foil**. The exposed fat could ignite.
6. Place the pan on the oven rack. **Open the oven door to the broil stop position when broiling** (See Fig 2).
7. Broil on one side until food is browned. Turn and broil food on 2nd side.  
**Note:** Always pull the oven rack out to the stop position before turning or removing the food.
8. When broiling is finished, press .

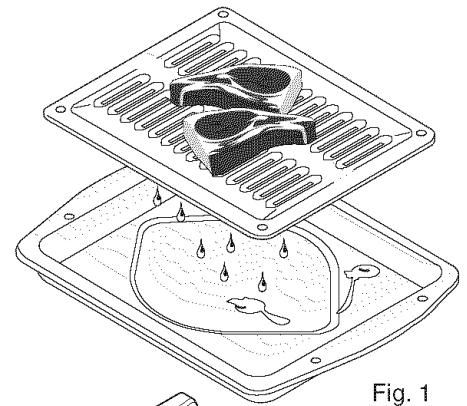

Fig. 1

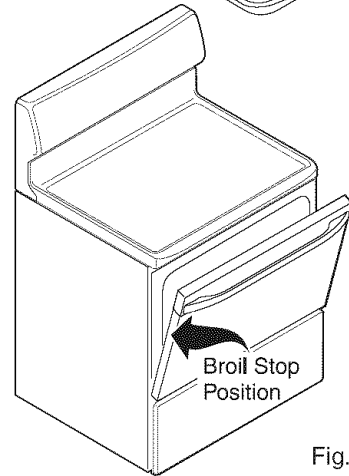

Fig. 2

## Broil Rack Position Table (Refer to Fig. 3)

Rack Position from Top	Food category
1st rack position	Medium steaks & hamburgers
2nd rack position	Fish, medium-well steaks & pork chops
3rd rack position	Well-done foods such as chicken & lobster

Note: The broiler pan and the insert allows grease to drain and be kept away from the high heat of the broiler. **DO NOT** use the pan without the insert (some models). **DO NOT** cover the insert with foil; the exposed grease could ignite.

**CAUTION** Should an oven fire occur, close the oven door and turn the oven OFF. If the fire continues, use a fire extinguisher. **DO NOT** put water or flour on the fire. Flour may be explosive.

## To Operate the Oven Light

The interior oven light will automatically turn ON when the oven door is opened. Press the Oven Light Switch located on the upper left control panel to turn the interior oven light ON and OFF whenever the oven door is closed (Fig. 4).

The interior oven light is located at the upper left rear wall of the oven interior and is covered with a glass shield held by a wire holder. The glass shield must be in place whenever the oven is in use. To change the interior oven light, see "Changing the Oven Light" in the **General Care & Cleaning** section.

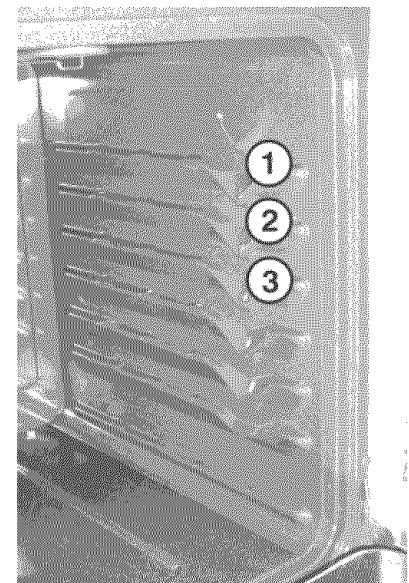

Fig. 3

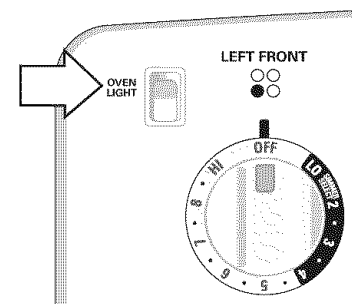

Fig. 4

# Self-Cleaning

**CAUTION** During the Self-Cleaning cycle, the outside of the range can become very hot to the touch. **DO NOT** leave small children unattended near the appliance.

**CAUTION** The health of some birds is extremely sensitive to the fumes given off during the Self-Cleaning cycle of any range. Move birds to another well-ventilated room.

**CAUTION DO NOT** line the oven walls, racks, bottom or any other part of the range with **aluminum foil**. Doing so will destroy heat distribution, produce poor baking results and cause permanent damage to the oven interior (aluminum foil will melt to the interior surface of the oven).

**CAUTION DO NOT** force the oven door open. This can damage the automatic door locking system. Use caution when opening the door after the Self-Cleaning cycle is completed. The oven may still be **VERY HOT**.

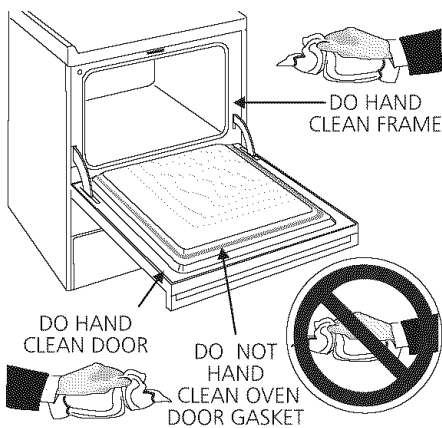

Note: See additional cleaning information for the oven door in the **General Care & Cleaning** section.

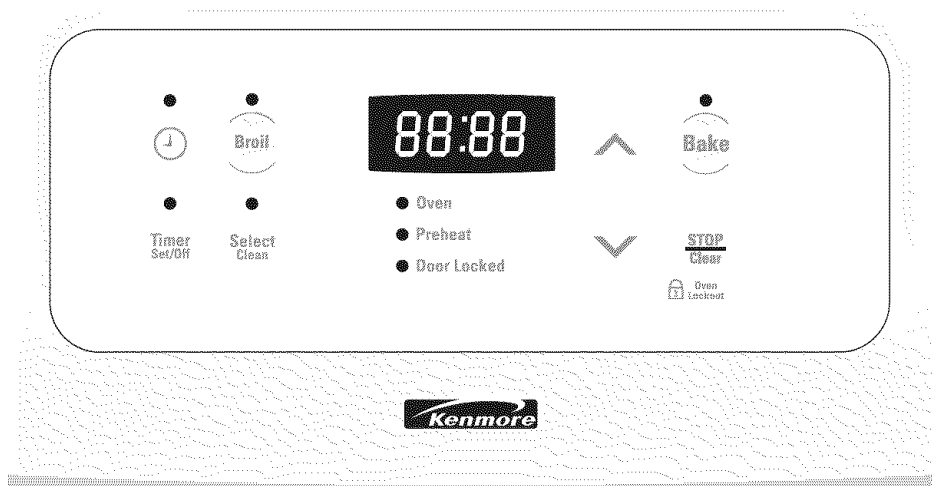
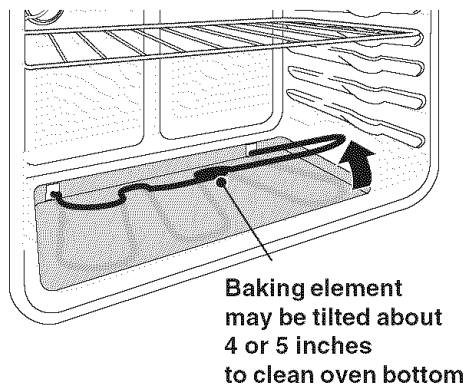

## Self-Cleaning Oven

A Self-Cleaning oven cleans itself with high temperatures (well above cooking temperatures) which eliminate soils completely or reduces them to a fine powdered ash you can wipe away with a damp cloth.

### Adhere to the following cleaning precautions:

- **DO NOT** use oven cleaners or oven protective coatings in or around any part of the Self-Cleaning oven.
- **DO NOT** clean the oven door gasket. The woven material of the oven door gasket is essential for a good seal. Care should be taken not to rub, damage or remove the gasket.
- **DO NOT** use any cleaning materials on the oven door gasket. Doing so could cause damage.
- **Remove the broiler pan and insert, all utensils and any aluminum foil. These items cannot withstand high cleaning temperatures.**
- Remove the oven racks. If they are not removed during the Self-Clean cycle their color will turn slightly blue and the finish will be dull. After the cycle is complete and the oven has cooled, rub the sides of the oven racks with wax paper or a cloth containing a small amount of salad oil (this will make the racks glide easier into the rack position).
- **Remove any excessive spillovers** in the oven cavity **before** starting the Self-Cleaning cycle. To clean, use hot, soapy water and a cloth. Large spillovers can cause heavy smoke or fire when subjected to high temperatures. **DO NOT** allow food spills with a high sugar or acid content (such as milk, tomatoes, sauerkraut, fruit juices or pie filling) to remain on the surface as they may leave a dull spot even after cleaning.
- Clean any soil from the oven frame, the door liner outside the oven door gasket and the small area at the front center of the oven bottom. These areas heat sufficiently to burn soil on. Clean with soap and water.

NOTE: Prior to setting the Self-Clean cycle, any spills remaining on the oven bottom should be removed.

Some models have an exposed Bake element in the lower oven cavity. On these models the bake element is designed to be tilted up using your hand from the front of the bake element. This will allow easier access to the oven bottom for cleaning. Be careful not to raise the element more than 4 or 5 inches from the resting position.





**CAUTION** The oven bake and broil elements may appear to have cooled after they have been turned OFF. **The elements may still be hot** and burns may occur if these elements are touched before they have cooled sufficiently.

# Self-Cleaning (cont'd)

## Starting the Select Self-Clean Cycle

For satisfactory results, use a 2 hour Self-Clean cycle for **light soils** and a 3 hour cycle for **average** or a 4 hour cycle for **heavy soils**. **NOTE:** The kitchen area should be well ventilated using an open window, ventilation fan or exhaust hood during the 1st Self-Clean cycle. This will help eliminate the normal odors associated with the 1st Self-Clean cycle.

## To Set the Controls for a Self-Clean Cycle:

1. Be sure the clock shows the correct time of day.
2. Press . "— — —" appears in the display.
3. Press the  or  once. "3:00" appears in the display for a 3 hour cycle. To change to a 2 hour cycle press .

"2:00" appears in the display or to select a 4 hour cycle press . "4:00" appears in the display.

As soon as the controls are set, the motor driven lock will begin to close automatically and the "LOCK" indicator light will flash. **DO NOT** open the oven door while the light is flashing (it takes about 15 seconds for the oven door to lock).

4. "CLn" will appear in the display during the Self-Clean cycle and the "LOCK" light will glow until the Self-Cleaning cycle is complete or cancelled and the oven temperature has cooled.

## When the Self-Clean Cycle is complete:

1. The time of day or "End" will appear in the display window and the "Clean" and "LOCK" light will continue to glow.
2. Once the oven has cooled down for about 1 HOUR and the "LOCK" light has gone out, the oven door can be opened.
3. If "End" is in the display and the Select Clean indicator light remains ON, press . The time of day will appear in the display.

**NOTE:** When the oven is cool, wipe away any residue or powdered ash with a damp cloth or paper towel.

## Stopping or Interrupting a Select Self-Cleaning Cycle

If it becomes necessary to stop or interrupt a Self-Cleaning cycle:

1. Press .
2. Once the oven has cooled down for about 1 HOUR and the "LOCK" light has gone out, the oven door can be opened.
3. Restart the Self-Clean cycle once all conditions have been corrected.

**CAUTION** To avoid possible burns use care when opening the oven door after the Self-Cleaning cycle. Stand to the side of the oven when opening the door to allow hot air or steam to escape.

**CAUTION** **DO NOT** force the oven door open. This can damage the automatic door locking system. Use caution and avoid possible burns when opening the door after the Self-Cleaning cycle has completed. The oven may still be VERY HOT.

# General Care & Cleaning

Cleaning Table

Surfaces	How to Clean
Aluminum (Trim Pieces) & Vinyl	Use hot, soapy water and a cloth. Dry with a clean cloth.
Painted and Plastic Control Knobs, Body Parts, and Decorative Trim	<i>For general cleaning</i> , use hot, soapy water and a cloth. <i>For more difficult soils and built-up grease</i> , apply a liquid detergent directly onto the soil. Leave on soil for 30 to 60 minutes. Rinse with a damp cloth and dry. <b>DO NOT</b> use abrasive cleaners on any of these materials; they can scratch. To remove control knobs, turn to the OFF position; grasp firmly and pull straight off the shaft. To replace knobs after cleaning, line up the flat sides of both the knob and the shaft; then push the knob into place.
Stainless Steel, Chrome Control Panel, Decorative Trim	<i>Before cleaning the control panel</i> , turn all controls to OFF and remove the control knobs. To remove, pull each knob straight off the shaft. Clean using hot, soapy water and a dishcloth. Rinse with a clean water using a dishcloth. Be sure to squeeze excess water from the cloth before wiping the panel; especially when wiping around the controls. Excess water in or around the controls may cause damage to the appliance. To replace knobs after cleaning, line up the flat sides of both the knob and the shaft; then push the knob into place.  Clean <b>stainless steel</b> with hot, soapy water and a dishcloth. Rinse with clean water and a cloth. <b>Do not use cleaners with high concentrations of chlorides or chlorines.</b> Do not use harsh scrubbing cleaners. Only use kitchen cleaners that are especially made for cleaning stainless steel. Always be sure to rinse the cleaners from the surface as bluish stains may occur during heating that cannot be removed.
Porcelain Enamel Broiler Pan and Insert, Door Liner, Body Parts, Warmer Drawer (some models)	Gentle scouring with a soapy scouring pad will remove most spots. Rinse with a 1:1 solution of clear water and ammonia. <i>If necessary</i> , cover difficult spots with an ammonia-soaked paper towel for 30 to 40 minutes. Rinse with clean water and a damp cloth, and then scrub with a soap-filled scouring pad. Rinse and wipe dry with a clean cloth. Remove all cleaners or the porcelain may become damaged during future heating. <b>DO NOT</b> use spray oven cleaners on the cooktop.
Oven Racks	Remove the oven racks before starting a Self-Clean cycle for cleaning. After removal, clean by using a mild, abrasive cleaner following manufacturer's instructions. Rinse with clean water and dry.  If the racks are cleaned in the Self-Clean cycle, their color will turn slightly blue and the finish will be dull. After the Self-Clean cycle is complete, and the oven has cooled, rub the sides of the racks with wax paper or a cloth containing a small amount salad oil (this will make the racks glide easier into the rack positions).
Oven door	Use soap & water to thoroughly clean the top, sides and front of the oven door. Rinse well. You may use a glass cleaner on the outside glass of the oven door. <b>DO NOT</b> immerse the door in water. <b>DO NOT spray or allow water or the glass cleaner to enter the door vents.</b> <b>DO NOT</b> use oven cleaners, cleaning powders or any harsh abrasive cleaning materials on the outside of the oven door.  <b>DO NOT</b> clean the oven door gasket. The oven door gasket is made of a woven material, on Self-Cleaning models, which is essential for a good seal. Care should be taken not to rub, damage or remove this gasket.
Surface Elements	See Surface Elements and Drip Bowls in the General Care & Cleaning section of this Use & Care Guide

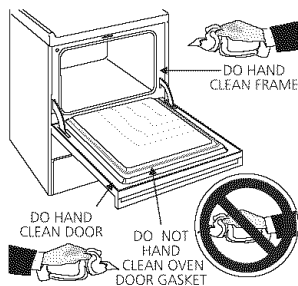
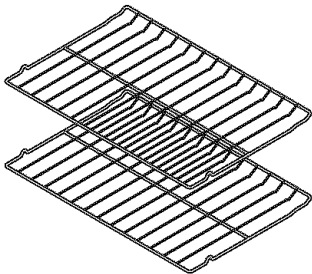



# General Care & Cleaning (cont'd)

## Surface Elements and Drip Bowls

Surface elements can be unplugged and removed to make cleaning the drip pans easier. The surface elements clean themselves when they are turned on. Food spilled on a hot element will burn off. Food spilled on a cool element may be cleaned with a damp cloth—any remaining soil will burn off the next time the element is used.

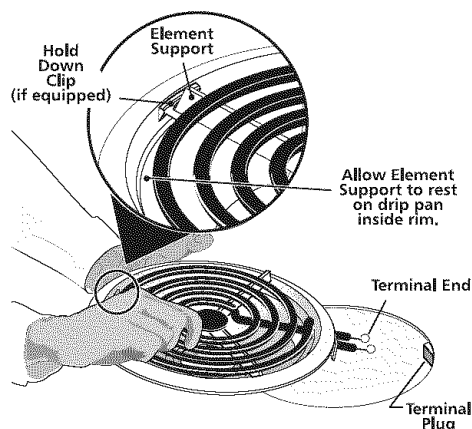

**CAUTION** Be sure the range is cool before removing elements or drip bowls. Be careful not to bend terminal ends when replacing elements after cleaning.

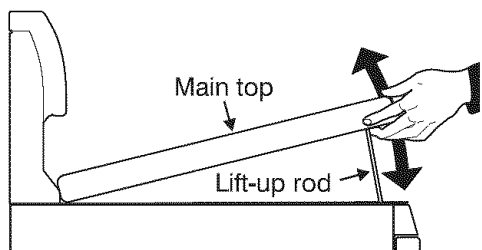

**CAUTION** When lowering the lift-up range top, grasp the sides with finger-tips only. Be careful not to pinch fingers. **DO NOT** drop or bend the range top when raising or lowering. This could damage the surface.

**CAUTION** Never immerse a surface element in water.

### To Remove the Surface Elements and Drip Bowls

1. Lift the edge of the drip bowl across from the terminal end. **Lift the surface element and drip bowl together** just enough to clear the cooktop.
2. While holding the drip bowl and surface element, gently pull the terminal end out from the terminal plug. If equipped, **DO NOT** remove the hold down clip from the drip bowl.

### To Clean Drip Bowls

Wash in hot, soapy water or in the dishwasher. Rinse and dry while still warm. Hard to remove, burned on soil can be removed by soaking the drip bowls for about 20 minutes in a lightly diluted liquid cleanser or a solution of ammonia and water (1/2 cup ammonia to 1 gallon of water). A nylon scrubber may be used after soaking. **DO NOT** use abrasive cleaners or steel wool, as they will scratch the surface. Always rinse with clean water and polish dry with a soft cloth.

### To Replace Drip Bowls and Surface Elements

1. Slide the terminal end on the element through the opening in the drip bowl.
2. Align the element support to rest on the rim inside the drip bowl. If your drip bowl is equipped with a hold down clip, align the element support opposite the terminal end with the slot in the hold down clip, and snap into place.
3. After the element is positioned in the drip bowl, line up the terminal end with the terminal plug as shown.
4. Hold the surface element and drip bowl together as level as possible and firmly push the terminal end into the terminal plug. Make sure element terminal is seated properly into terminal plug. Make sure the surface element is level to reduce the hazard of pans sliding off the element.

### To Raise the Top for Cleaning

1. Grasp the sides and lift from the front. Lift-up rods will support the top in a raised position. Only lift the top far enough to allow the support rods to snap into place.
2. Clean underneath using a clean cloth and hot, soapy water.
3. To lower the top, gently push back on each rod to release the notched support. Hold the range top and slide the lift rods down into the range frame.

# General Care & Cleaning

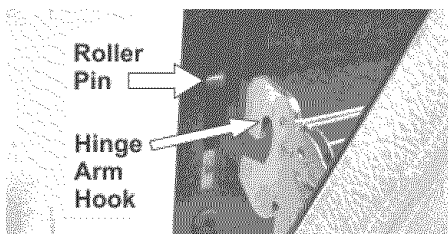
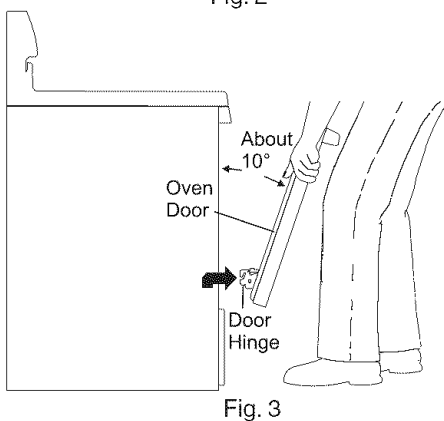
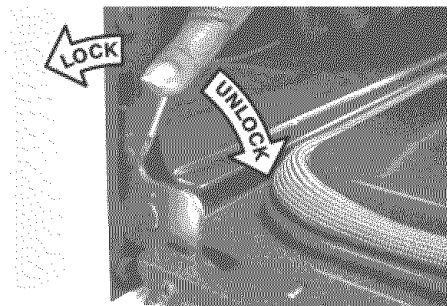
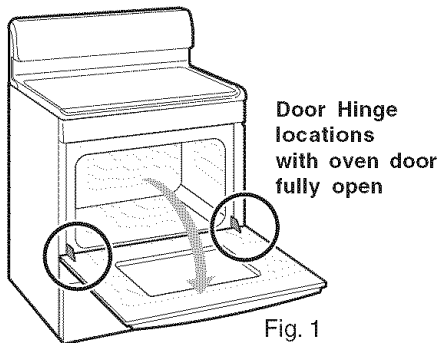

## Removing and Replacing the Lift-Off Oven Door

**CAUTION** The door is heavy. For safe, temporary storage, lay the door flat with the inside of the door facing down.

### To Remove Oven Door:

1. Open oven door completely (horizontal with floor - See Fig. 1).
2. Pull the door hinge locks on both left and right door hinges down from the oven frame completely towards the oven door (See Fig. 2). A tool such as a small flat-blade screwdriver may be required.
3. Firmly grasp both sides of oven door along the door sides (Do not use the oven door handle - See Fig. 3).
4. Close the door to the broil stop position (the oven door will stop into this position just before fully closing).
5. With the oven door in the broil stop position, lift the oven door hinge arms over the roller pins located on each side of the oven frame (See Fig. 4).

### To Replace Oven Door:

1. Firmly grasp both sides of oven door along the door sides (Do not use the oven door handle - See Fig. 3).
2. Holding the oven door at the same angle as the removal position, seat the hook of the hinge arm over the roller pins located on each side of the oven door frame (See Fig. 4). The hook of the hinge arms must be fully seated onto the roller pins.
3. Fully open the oven door (horizontal with floor - See Fig. 1).
4. Push the door hinge locks up towards and into the oven frame on both left and right oven door hinges (See Fig. 2) to the locked position.
5. Close the oven door.

### Special Door Care Instructions

**Most oven doors contain glass that can break. Read the following recommendations:**

1. Do not close the oven door until all the oven racks are fully in place.
2. Do not hit the glass with pots, pans, or any other object.
3. Scratching, hitting, jarring or stressing the glass may weaken its structure causing an increased risk of breakage at a later time.

# General Care & Cleaning

## Changing the Oven Light (some models)

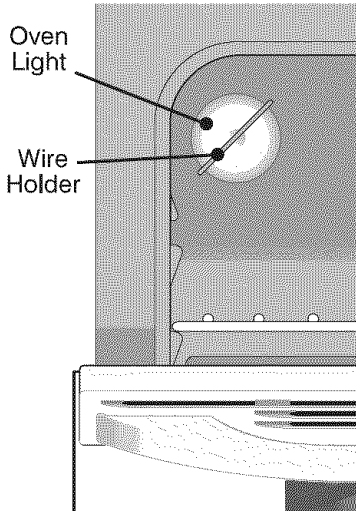

For models equipped with the interior oven light, the light bulb is located at the rear of the oven and is covered with a glass shield held by a wire holder. The glass shield must be in place whenever the oven is in use.

### To replace the oven light bulb:

1. Turn electrical power off at the main source or unplug the range.
2. Press wire holder to one side to release the glass shield.
3. Replace bulb with a new 40 watt appliance bulb.
4. Replace glass shield over bulb and snap wire holder into place.
5. Turn power back on again at the main source (or plug the range back in).
6. The clock will then need to be reset. To reset, see **Setting the Clock and Minute Timer** in this Use & Care Guide.

**CAUTION** Be sure the range is unplugged and all parts are COOL before replacing oven light. Wear a leather-faced glove for protection against possible broken glass.

## Care and Cleaning of Stainless Steel (some models)

Some models are equipped with stainless steel exterior parts. Special care and cleaning are **required** for maintaining the appearance of stainless parts. Refer to the **Care & Cleaning** table for detailed cleaning instructions.

## Adjusting the Oven Temperature

Your oven control has been precisely set at the factory. This setting may differ from your previous oven however, so your recipe times may not give you the results you expect. If you think that the oven is cooking too hot or too cool for your recipe times, you can adjust the control so that the oven cooks hotter or cooler than the temperature displayed.

### To Adjust Oven Temperature:

1. Press **Bake**.
2. Set the temperature to 550°F (287°C) by pressing and holding the **▲**.
3. Within 2 seconds, press and hold **Bake** until the 2 digit display appears. Release **Bake**. The display now indicates the amount of degrees offset between the original factory temperature setting and the current temperature setting. If the oven control has the original factory calibration, the display will read "0."
4. The temperature can now be adjusted up or down 35°F (17°C), in 5°F steps by pressing and holding the **▲** or **▼**. Adjust until the desired amount of offset appears in the display. When lowering the oven temperature, a minus sign (-) will appear before the number to indicate that the oven will be cooler by the displayed amount of degrees.
5. When you have made the desired adjustment, press **STOP Clear** to go back to the time of day display.

**Note:** Oven temperature adjustments made will not change the Self-Cleaning feature temperature.

# Before You Call

## Solutions to Common Problems

**Before you call for service**, review this list. It may save you time and expense. The list includes common occurrences that are not the result of defective workmanship or materials in this appliance.

<b>OCCURRENCE</b>	<b>POSSIBLE CAUSE/SOLUTION</b>
<b>Range is not level.</b>	<p>Poor installation. Place oven rack in center of oven. Place a level on the oven rack. Adjust leveling legs at base of range until the oven rack is level.</p> <p>Be sure floor is level and is strong and stable enough to adequately support range.</p> <p>If floor is sagging or sloping, contact a carpenter to correct the situation.</p> <p>Kitchen cabinet alignment may make range appear unlevel. Be sure cabinets are square and have sufficient room for range clearance.</p>
<b>Cannot move appliance easily. Appliance must be accessible for service.</b>	<p>Cabinets not square or are built in too tightly. Contact builder or installer to make appliance accessible.</p> <p>Carpet interferes with range. Provide sufficient space so range can be lifted over carpet.</p>
<b>Oven control beeps and displays any F code error (for example F11).</b>	<p>Electronic control has detected a fault condition. Press <b>STOP/CLEAR</b> to clear the display and stop beeping. Reprogram oven. If fault recurs, record fault number. Press <b>STOP/CLEAR</b> and call <b>1-800-4-MY-HOME®</b> for assistance (See back cover).</p>
<b>Surface element too hot or not hot enough.</b>	<p>Incorrect control setting. Make sure the correct control is on for the element to be used.</p>
<b>Surface element does not heat.</b>	<p>Lightweight or warped pans used. Use only flat, evenly balanced, medium or heavyweight cookware. Flat pans heat better than warped pans. Cookware materials and weight of the material affect heating. Heavy and medium-weight pans heat evenly. Because lightweight pans heat unevenly, foods may burn easily.</p> <p>No power to the appliance. Check steps under "Entire Appliance Does Not Operate" in this <b>Before You Call</b> checklist.</p> <p>Incorrect control setting. Make sure the correct control is set for the surface element to be used.</p>
<b>Entire appliance does not operate.</b>	<p>Make sure cord/plug is plugged correctly into outlet.</p> <p>Service wiring is not complete. Call <b>1-800-4-MY-HOME®</b> for assistance (See back cover).</p> <p>Power outage. Check house lights to be sure. Call your local electric company for service.</p>

# Before You Call

Solutions to Common Problems

## OCCURRENCE

## POSSIBLE CAUSE/SOLUTION

Oven light does not work.

Replace or tighten bulb. See **Changing Oven Light** section in this Use & Care Guide.

Oven smokes excessively during broiling.

Control(s) not set properly. Follow instructions under **Setting Oven Controls**.

Make sure oven door is opened to **broil stop position**.

Meat too close to the element. Reposition the rack to provide proper clearance between the meat and the element. Preheat broil element for searing.

Meat not properly prepared. Remove excess fat from meat. Cut remaining fatty edges to prevent curling, but do not cut into lean.

Insert on broiler pan wrong side up and grease not draining. Always place grid on the broiler pan with ribs up and slots down to allow grease to drip into pan.

Grease has built up on oven surfaces. Regular cleaning is necessary when broiling frequently. Old grease or food spatters cause excessive smoking.

Poor baking results.

Many factors affect baking results. Make sure the proper rack position is used. Center food in the oven and space pans to allow air to circulate. Allow the oven to preheat to the set temperature before placing food in the oven. Try adjusting the recipe's recommended temperature or baking time. If you feel the oven is too hot or cool, see **Adjusting Your Oven Temperature** in this Use & Care Guide.

Self-Cleaning cycle does not work.

Control(s) not set properly. Follow instructions under **Self-Cleaning**.

Self-Cleaning cycle was interrupted. Follow steps under "Stopping or Interrupting a Self-Cleaning Cycle" under **Self-Cleaning**.

Soil not completely removed after Self-Cleaning cycle.

Failure to clean bottom, front top of oven, frame of oven or door area outside oven seal. These areas are not in the self-cleaning area, but get hot enough to burn on residue. Clean these areas before the self-cleaning cycle is started. Burned-on residue can be cleaned with a stiff nylon brush and water or a nylon scrubber. Be careful not to damage the oven gasket.

Flames inside oven or smoking from vent.

Excessive spillovers in oven. Set Self-Clean cycle for a longer cleaning time.

Excessive spillovers in oven. This is normal, especially for high oven temperatures, pie spillovers or large amounts of grease on bottom of oven. Wipe up excessive spillovers before starting cycle. If flames or excessive smoke are present, stop the self-clean cycle and follow steps under "Stopping or Interrupting a Self-Cleaning Cycle" in the **Self-Cleaning** section.

Drip bowls are pitting or rusting (Coil cooktop models only).

Foods with acids, such as tomatoes, if allowed to stand in/on bowls will cause corrosion. Remove and wash drip bowls as soon as possible after a spillover

Normal environment. Houses along sea coast are exposed to salt air. Protect bowls as much as possible from direct exposure to salt air.

Drip bowls turning color or distorted (Coil cooktop models only).

Bottom surface of cookware extends beyond surface elements and touches cooktop surface. This can cause high enough temperatures to discolor the drip bowls. **DO NOT** use cookware of this type. Pan sizes should be matched to the size of the element. Replacement drip bowls may be purchased from your dealer.

# Get it fixed, at your home or ours!

## Your Home

For repair – **in your home** – of **all** major brand appliances, lawn and garden equipment, or heating and cooling systems, **no matter who made it, no matter who sold it!**

For the replacement parts, accessories and owner's manuals that you need to do-it-yourself.

For Sears professional installation of home appliances and items like garage door openers and water heaters.

**1-800-4-MY-HOME® (1-800-469-4663)**

Call anytime, day or night (U.S.A. and Canada)

[www.sears.com](http://www.sears.com)    [www.sears.ca](http://www.sears.ca)

---

## Our Home

For repair of carry-in items like vacuums, lawn equipment, and electronics, call or go on-line for the location of your nearest

**Sears Parts & Repair Center.**

**1-800-488-1222**

Call anytime, day or night (U.S.A. only)

[www.sears.com](http://www.sears.com)

---

To purchase a protection agreement (U.S.A.)  
or maintenance agreement (Canada) on a product serviced by Sears:

**1-800-827-6655** (U.S.A.)

**1-800-361-6665** (Canada)

---

Para pedir servicio de reparación  
a domicilio, y para ordenar piezas:

**1-888-SU-HOGAR®**

(1-888-784-6427)

Au Canada pour service en français:

**1-800-LE-FOYER<sup>MC</sup>**

(1-800-533-6937)

[www.sears.ca](http://www.sears.ca)

The Sears logo is displayed in a large, bold, serif font. The word "Sears" is written in a dark color, with a thin, curved line underneath the letters "e" and "a".

## Free Manuals Download Website

<http://myh66.com>

<http://usermanuals.us>

<http://www.somanuals.com>

<http://www.4manuals.cc>

<http://www.manual-lib.com>

<http://www.404manual.com>

<http://www.luxmanual.com>

<http://aubethermostatmanual.com>

Golf course search by state

<http://golfingnear.com>

Email search by domain

<http://emailbydomain.com>

Auto manuals search

<http://auto.somanuals.com>

TV manuals search

<http://tv.somanuals.com>