

**Use & Care Guide**  
**Guía de uso y cuidada**  
**English / Español**

**Model/Modelos: 790.7433, 7434\***

# Kenmore®

## Gas Range

## Estufa de gas

\* = color number, número de color

P/N 807189701 Rev A

Sears Brands Management Corporation  
Hoffman Estates, IL 60179 U.S.A.

[www.kenmore.com](http://www.kenmore.com)  
[www.sears.com](http://www.sears.com)

Sears Canada, Inc.  
Toronto (Ontario) Canada M5B 2B8  
[www.sears.ca](http://www.sears.ca)



# Table of Contents

Please carefully read and save these instructions .....	2	Setting Surface Controls .....	13
Kenmore One Year Limited Warranty .....	2	Setting Surface Burners .....	13
Before Setting Oven Controls .....	9	Oven Controls .....	14
Oven Vent Location .....	9	Minimum and Maximum Control Settings .....	14
Before Setting Surface Controls .....	10	Warmer Drawer .....	26
Using Proper Cookware .....	11	Self Clean .....	28
Cookware Material Types .....	11	Care & Cleaning .....	30
Setting Proper Burner Flame Size .....	11	Before You Call .....	34
Home Canning .....	12	Oven Baking .....	34
		Solutions to Common Problems .....	35

---

## Please carefully read and save these instructions

This Use & Care Guide contains operating instructions for your appliance and feature information for several models. Your product may not have all the described features. The graphics shown are representative. The graphics on your appliance may not look exactly like those shown. Common sense and caution must be practiced with installing, operating and maintaining any appliance.

## Kenmore One Year Limited Warranty

When installed, operated and maintained according to all supplied instructions, if this appliance fails due to a defect in material and workmanship within one year from the date of purchase, call 1-800-4-MY-HOME® to arrange for free repair.

If this appliance is ever used for other than private family purposes, this warranty applies for only 90 days from the date of purchase.

### This warranty covers **ONLY** defects in material and workmanship. Sears will **NOT** pay for:

1. Cracks in a ceramic glass cooktop that are not a result of thermal shock.
2. Stains and scratches on a ceramic glass cooktop resulting from accident or improper operation or maintenance.
3. Expendable items that can wear out from normal use, including but not limited to filters, belts, incandescent light bulbs and bags.
4. A service technician to instruct the user in correct product installation, operation or maintenance.
5. A service technician to clean or maintain this product.
6. Damage to or failure of this product if it is not installed, operated or maintained according to all instructions supplied with the product.
7. Damage to or failure of this product resulting from accident, abuse, misuse or use for other than its intended purpose.
8. Damage to or failure of this product caused by the use of detergents, cleaners, chemicals or utensils other than those recommended in all instructions supplied with the product.
9. Damage to or failure of parts or systems resulting from unauthorized modifications made to this product.

### Disclaimer of implied warranties; limitation of remedies

Customer's sole and exclusive remedy under this limited warranty shall be product repair as provided herein. Implied warranties, including warranties of merchantability or fitness for a particular purpose, are limited to one year or the shortest period allowed by law. Sears shall not be liable for incidental or consequential damages. Some states and provinces do not allow the exclusion or limitation of incidental or consequential damages, or limitation on the duration of implied warranties of merchantability or fitness, so these exclusions or limitations may not apply to you.

This warranty applies only while this appliance is used in the United States or Canada\*.

This warranty gives you specific legal rights, and you may also have other rights which vary from state to state.

\* In Canada, in-home repair service is not available in all areas, nor will this warranty cover user or servicer travel and transportation expenses if this product is located in a remote area (as defined by Sears Canada Inc.) where an authorized servicer is not available.

**Sears Brands Management Corporation, Hoffman Estates, IL 60179**

**Sears Canada Inc., Toronto, Ontario, Canada M5B 2C3**

All rights reserved. Printed in the USA.

# IMPORTANT SAFETY INSTRUCTIONS

Read all instructions before using this appliance.

This manual contains important safety symbols and instructions. Pay attention to these symbols and follow all instructions given.

Do not attempt to install or operate your appliance until you have read the safety precautions in this manual. Safety items throughout this manual are labeled with a **WARNING** or **CAUTION** statement based on the hazard type.

## DEFINITIONS

**⚠** This is the safety alert symbol. It is used to alert you to potential personal injury hazards. Obey all safety messages that follow this symbol to avoid possible injury or death.

**⚠ WARNING** - Indicates a potentially hazardous situation which, if not avoided, may result in death or serious injury.

**⚠ CAUTION** - Indicates a potentially hazardous situation which, if not avoided, may result in minor or moderate injury.

**Important:** Indicates installation, operation, maintenance, or valuable information that is not hazard related.

Air curtain or other overhead range hoods, which operate by blowing a downward air flow on to a range, shall not be used in conjunction with gas ranges other than when the hood and range have been designed, tested and listed by an independent test laboratory for use in combination with each other.

**⚠ WARNING** Do Not Leave Children Alone - Children should not be left alone or unattended in the area where appliance is in use. They should never be allowed to sit or stand on any part of the appliance, including the storage drawer, lower broiler drawer, warmer drawer, or lower double oven.

**⚠ WARNING** If the information in this manual is not followed exactly, a fire or explosion may result causing property damage, personal injury or death.

## FOR YOUR SAFETY:

- Do not store or use gasoline or other flammable vapors and liquids in the vicinity of this or any other appliance.
- WHAT TO DO IF YOU SMELL GAS:
  - Do not try to light any appliance.
  - Do not touch any electrical switch; do not use any phone in your building.
  - Immediately call your gas supplier from a neighbor's phone. Follow the gas supplier's instructions.
  - If you cannot reach your gas supplier, call the fire department.
- Installation and service must be performed by a qualified installer, servicer or the gas supplier.

**⚠ WARNING** Never cover any slots, holes, or passages in the oven bottom or cover an entire oven rack with materials, such as aluminum foil. Doing so blocks air flow through the oven and may cause carbon monoxide poisoning. Aluminum foil linings may trap heat, causing a fire hazard.

**⚠ WARNING** Storage In or On Appliance—Flammable materials should not be stored in an oven, near surface units or in the storage drawer, warmer drawer or lower oven. This includes paper, plastic, and cloth items, such as cookbooks, plastic ware, and towels, as well as flammable liquids. Do not store explosives, such as aerosol cans, on or near the range.

Save these instructions for future reference.

# IMPORTANT SAFETY INSTRUCTIONS

Read all instructions before using this appliance.

## **⚠ WARNING**

### **Tip Over Hazard**

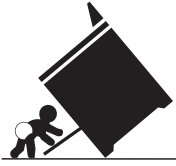

- A child or adult can tip the range and be killed.
- Verify the anti-tip device has been installed to floor or wall.

- Ensure the anti-tip device is re-engaged to floor or wall when the range is moved.
- Do not operate the range without the anti-tip device in place and engaged.
- Failure to follow these instructions can result in death or serious burns to children and adults.

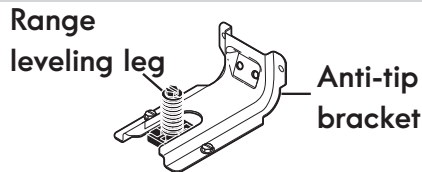

To check if the anti-tip bracket is installed properly, use both arms and grasp the rear edge of the range back. Carefully attempt to tilt range forward. When properly installed, the range should not tilt forward.

Refer to the anti-tip bracket installation instructions supplied with your range for proper installation.

**⚠ WARNING** Stepping, leaning, or sitting on the door or drawers of a range can result in serious injuries and also cause damage to the appliance. Do not allow children to climb or play around the range. The weight of a child on an open over door may cause the range to tip, resulting in serious burns or other injury.

**⚠ CAUTION** Wear proper apparel. Loose-fitting or hanging garments should never be worn while using this appliance. Do not let clothing or other flammable materials come into contact with hot surfaces.

**⚠ CAUTION** Do not heat unopened food containers. Build-up of pressure may cause container to burst and result in injury.

**⚠ CAUTION** When heating fat or grease, watch it closely. Grease may catch fire if it becomes too hot.

**⚠ CAUTION** Do not use water or flour on grease fires. Smother fire or flame or use dry chemical or foam-type extinguisher. Cover the fire with a pan lid or use baking soda.

**⚠ CAUTION** Use dry potholders. Moist or damp potholders on hot surfaces may result in burns from steam. Do not let potholders touch hot cooking areas. Do not use towels or other bulky cloths.

**⚠ CAUTION** Do not store items of interest to children in the cabinets above a range or on the backguard of the range. Children climbing on the range to reach items could be seriously injured.

**Important:** Important Safety Notice - The California Safe Drinking Water and Toxic Enforcement Act requires the governor of California to publish a list of substances known to cause cancer, birth defects, or other reproductive harms, and it requires businesses to warn customers of potential exposures to such substances.

Save these instructions for future reference.

# IMPORTANT SAFETY INSTRUCTIONS

Read all instructions before using this appliance.

**⚠ CAUTION** Read and follow the below instructions and precautions for unpacking, installing, and servicing your appliance:

- Remove all tape and packaging before using the range. Destroy the carton and plastic bags after unpacking the range. Never allow children to play with packaging material.
- Proper Installation—Be sure your appliance is properly installed and grounded by a qualified technician in accordance with the National Fuel Gas Code ANSI Z223.- latest edition, or in Canada CAN/CGA B149.1, and CAN/CGA B149.2, and the National Electrical Code ANSI/NFPA No.70-latest edition, or in Canada CSA Standard C22.1, Canadian Electrical Code, Part 1, and local code requirements. Install only per installation instructions provided in the literature package for this range.
- User Servicing—Do not repair or replace any part of the appliance unless specifically recommended in the manuals. All other servicing should be done only by a qualified technician. This reduces the risk of personal injury and damage to the range.
- Ask your dealer to recommend a qualified technician and an authorized repair service. Know how to disconnect the power to the range at the circuit breaker or fuse box in case of an emergency.
- Never modify or alter the construction of an range by removing the leveling legs, panels, wire covers, anti-tip brackets/screws, or any other part of the range.
- Remove the oven door from any unused range if it is to be stored or discarded.
- For electric ignition models only--Do not attempt to operate the range during a power failure. If the power fails, always turn off the range. If the range is not turned off and the power resumes, the range will begin to operate again. Once the power resumes, reset the clock and oven function.
- Cold temperatures can damage the electronic control. When using this appliance for the first time, or when the appliance has not been used for an extended period of time, be sure the appliance has been in temperatures above 32°F (0°C) for at least 3 hours before turning on the power to the appliance.
- Be sure to have an appropriate foam-type fire extinguisher available, visible, and easily located near the appliance.

## IMPORTANT INSTRUCTIONS FOR USING YOUR OVEN

- Never use your appliance for warming or heating the room. Doing so may result in carbon monoxide poisoning.
- Use care when opening oven door, lower oven door, or warmer drawer (some models). Stand to the side of the range when opening the door of a hot oven. Let hot air or steam escape before you remove or replace food in the oven.
- Keep oven vent ducts unobstructed. The oven vent is located below the backguard. Touching surfaces in this area when the oven is on may cause severe burns. Do not place plastic or heat-sensitive items on or near the oven vent. These items can melt or ignite.
- Do not cook food on the oven bottom. Always cook in proper bakeware and always use the oven racks.

Save these instructions for future reference.

# IMPORTANT SAFETY INSTRUCTIONS

Read all instructions before using this appliance.

- Placement of Oven Racks - Always place oven racks in desired location while oven is cool. If rack must be moved while oven is hot, use extreme caution and do not let potholder contact hot heating element in oven. Use potholders and grasp the rack with both hands to reposition. Remove all bakeware and utensils before moving the rack.
- Do not use a broiler pan without its insert. Broiler pans and inserts allow dripping fat to drain away from the high heat of the broiler. Do not cover the broiler insert with aluminum foil; exposed fat and grease could ignite.
- Protective Liners - Do not use aluminum foil to line oven bottoms, except as suggested in the manual. Improper installation of these liners may result in a risk of electric shock, or fire.

## IMPORTANT INSTRUCTIONS FOR USING YOUR COOKTOP

**⚠ WARNING** Use Proper Flame Size — Adjust flame size so it does not extend beyond the edge of the utensil. The use of undersized utensils will expose a portion of the burner flame to direct contact and may result in ignition of clothing. Proper relationship of utensil to flame will also improve efficiency.

- Know which knob controls each surface heating unit. Place a pan of food on the surface element unit before turning it on, and turn the element off before removing the pan.
- When flaming foods under a ventilating hood, turn the fan on.
- Use proper pan size — This appliance is equipped with one or more surface units of different sizes. Select utensils having flat bottoms large enough to cover the surface unit heating element. The use of undersized utensils will expose a portion

of the heating element to direct contact and may result in ignition of clothing. Proper relationship of utensil to element will also improve efficiency.

- Utensil handles should be turned inward and not extend over adjacent surface elements — To reduce the risk of burns, ignition of flammable materials, and spillage due to unintentional contact with the utensil, the handle of the utensil should be positioned so that it is turned inward, and does not extend over adjacent surface units.
- Never leave surface elements unattended at high heat settings — Boilovers cause smoking and greasy spillovers that may ignite, or a pan that has boiled dry may melt.
- Glazed cooking utensils — Only certain types of glass, glass/ceramic, ceramic, earthenware, or other glazed utensils are suitable for cook top service without breaking due to the sudden change in temperature. Check the manufacturer's recommendations for cook top use.
- Improper cookware may break due to sudden changes in temperature. Check the cookware manufacturer's recommendations for cooktop use.
- Do not use decorative surface burner covers. If an element is accidentally turned on, the decorative cover will become hot and possibly melt. Burns will occur if the hot covers are touched. Damage may also be done to the cooktop.
- Always turn knob to the full LITE position when igniting top burners. Visually check that burner has lit. Then adjust the flame so it does not extend beyond the edge of the utensil.

Save these instructions for future reference.

# IMPORTANT SAFETY INSTRUCTIONS

Read all instructions before using this appliance.

## IMPORTANT INSTRUCTIONS FOR CLEANING YOUR RANGE

**⚠ CAUTION** Before manually cleaning any part of the range, be sure all controls are turned off and the range is cool. The range may be hot and can cause burns.

- Clean the range regularly to keep all parts free of grease that could catch fire. Pay particular attention to the area around each surface element. Do not allow grease to accumulate.
- Always follow the manufacturer's recommended directions for use of kitchen cleaners and aerosols. Be aware that excess residue from cleaners and aerosols may ignite causing damage and injury.
- Clean ventilating hoods frequently. Grease should not be allowed to accumulate on the hood or filter. Follow the manufacturer's instructions for cleaning hoods.

## IMPORTANT INSTRUCTIONS FOR CLEANING YOUR SELF-CLEANING OVENS

- Clean only the parts listed in this manual. Before using self-clean, remove the broiler pan, any food, utensils, and bakeware from the oven. Remove oven racks unless otherwise instructed.
- Do Not Use Oven Cleaners. No commercial oven cleaner or oven liner protective coating of any kind should be used in or around any part of the oven.
- Do Not Clean Door Gasket. The door gasket is essential for a good seal. Care should be taken not to rub, damage, or move the gasket.
- Some birds are extremely sensitive to the fumes given off during the self-clean cycle of any oven. Move birds to another well-ventilated room.

**⚠ CAUTION** DO NOT TOUCH SURFACE HEATING UNITS, OR SURFACE COOKING ELEMENTS, AREAS NEAR THESE SURFACE HEATING UNITS, OR INTERIOR SURFACE OF THE OVEN. Both surface heating and oven heating elements may be hot even though they are dark in color. Areas near surface cooking units may become hot enough to cause burns. During and after use, do not touch, or let clothing or other flammable materials touch these areas until they have had sufficient time to cool. Among these areas are the cook top, surfaces facing the cook top, the oven vent openings and surfaces near these openings, oven door and oven door window.

## CONVERSION TO L.P. GAS

**⚠ WARNING** Personal injury or death from electrical shock may occur if the conversion to L.P. gas is not made by a qualified installer or electrician.

**⚠ WARNING** Any additions, changes or conversions required in order for this appliance to satisfactorily meet the application needs must be made by a qualified technician.

This appliance allows for conversion to Liquefied Petroleum (L.P.) Gas.

If L.P. conversion is needed, contact your local L.P. Gas provider for assistance. The L.P. conversion kit is provided with this appliance and is located on the lower REAR (back side) panel of the range. Before installing the kit be sure to read the L.P. Installation Instructions and follow them carefully when making the installation.

Save these instructions for future reference.

# IMPORTANT SAFETY INSTRUCTIONS

Read all instructions before using this appliance.

## GROUNDING INSTRUCTIONS

**⚠ WARNING** Avoid fire hazard or electrical shock. Do not use an adapter plug, an extension cord, or remove grounding prong from electrical power cord. Failure to follow this warning can cause serious injury, fire or death.

This appliance is equipped with a 3-prong grounding plug for your protection against shock hazard and should be plugged directly into a properly grounded receptacle. Do not cut or remove the grounding prong from this plug.

For personal safety, the range must be properly grounded. For maximum safety, the power cord must be plugged into an electrical outlet that is correctly polarized and properly grounded.

If a 2-prong wall receptacle is the only available outlet, it is the personal responsibility of the consumer to have it replaced with a properly grounded 3-prong wall receptacle installed by a qualified electrician.

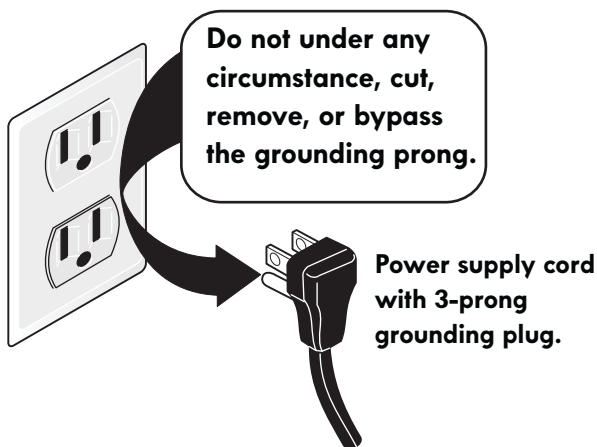

Figure 1: Grounding type wall receptacle

See the installation instructions packaged with this range for complete installation and grounding instructions.

## PRODUCT RECORD

In this space below, record the date of purchase, model and serial number of your product. You will find the model and serial number printed on an identification plate. See [Figure 2](#) for serial plate location.

Model No. \_\_\_\_\_

Serial No. \_\_\_\_\_

Date of Purchase \_\_\_\_\_

Save sales receipt for future reference.

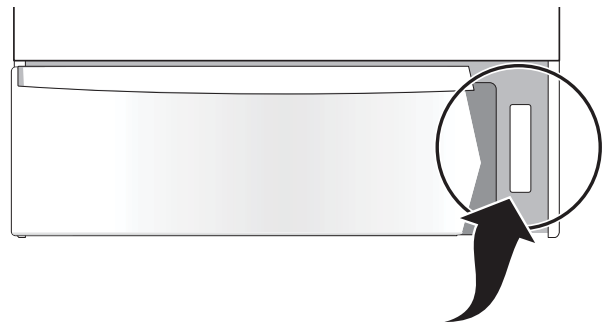

Figure 2: Serial plate location

To locate the serial plate, open storage drawer (some models) or warmer drawer (some models). The serial plate is attached to the lower right oven frame.

Save these instructions for future reference.



# Before Setting Oven Controls

## Oven Vent Location

The oven vent is located below the control panel (See [Figure 3](#)). When the oven is on, warm air passes through this vent. This venting is necessary for proper air circulation in the oven and good baking results. Do not block oven vent.

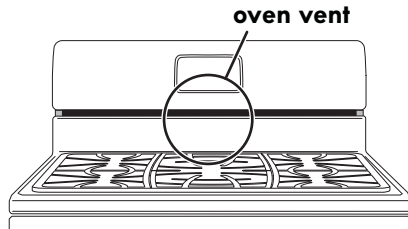

**Figure 3: Do not block oven vent location**

**⚠ WARNING** Do not line the oven walls, racks, bottom or any other part of the range with aluminum foil. Doing so will destroy heat distribution, produce poor baking results and cause permanent damage to the oven interior. Aluminum foil will melt to the interior of the oven.

**⚠ CAUTION** Always use pot holders or oven mitts when using the oven. When cooking, the oven interior and exterior, as well as the oven racks, will become very hot which can cause burns.

### Removing, replacing, and arranging flat or offset oven racks

**To Arrange** - Always arrange the oven racks when the oven is cool (prior to operating the oven).

**To Remove** - Pull the oven rack straight forward until it reaches the stop position. Lift up front of oven rack slightly and slide out.

**To Replace** - Place the oven rack on the rack guides on both sides of oven walls. Tilt the front of oven rack upward slightly and slide the oven rack back into place. Be sure oven racks are level before using.

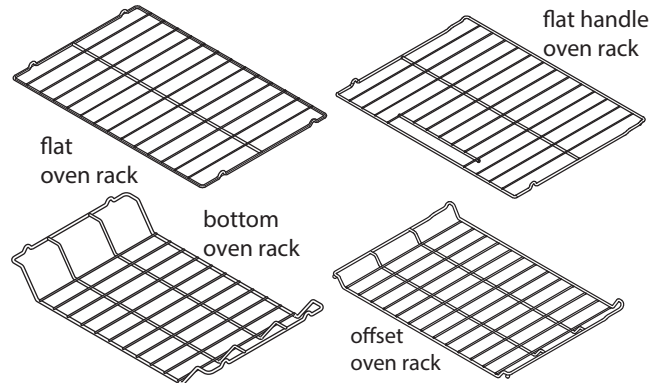

**Figure 4: Oven rack types**

### Oven Rack Descriptions

- Flat oven racks (or the flat handle oven rack) may be used for most cooking needs and may be placed in most oven rack positions.
- The offset oven rack (some models) provides additional stepdown positions from the standard flat rack design. The offset design positions the base of the rack about 1/2 of a rack position lower than the flat rack and may be used in most oven rack positions.
- To maximize oven cooking space, place the bottom oven rack (some models) in the lowest rack position for baking or roasting large cuts of meat.

### Air Circulation in the Oven

For best baking results allow 2-4" (5-10 cm) around the cookware for proper air circulation and be sure pans and cookware do not touch each other, the oven door, sides or back of the oven cavity. Hot air must be able to circulate around the cookware in the oven for even heat to reach around the food.

# Before Setting Surface Controls

## Check Burner Cap Placement Before Operating the Surface Burners

**⚠ WARNING** To prevent flare-ups and avoid creation of harmful by-products, do not use the cooktop without all burner caps properly installed to insure proper ignition and gas flame size.

It is very important to be sure that all surface burner caps and burner grates are properly installed and in the correct locations before operating the cooktop burners.

### Important notes:

- Always keep surface burner caps in place whenever using a surface burner.
- When placing the burner caps, be sure that all burner caps are seated firmly and rest level on top of burner heads.
- For proper flow of gas and ignition of burners do not allow spills, food, cleaning agents or any other material to enter the gas orifice port opening.

On round style burners, the burner cap lip (See Figure 5) should fit snug into the center of burner head and rest level.

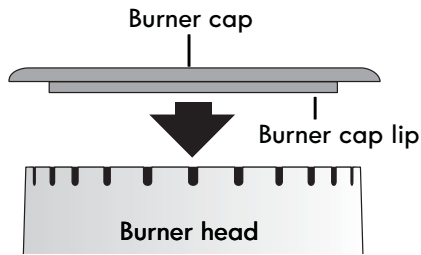

Figure 5: Burner cap lip placement

Refer to Figure 6 for correct and incorrect burner cap placement.

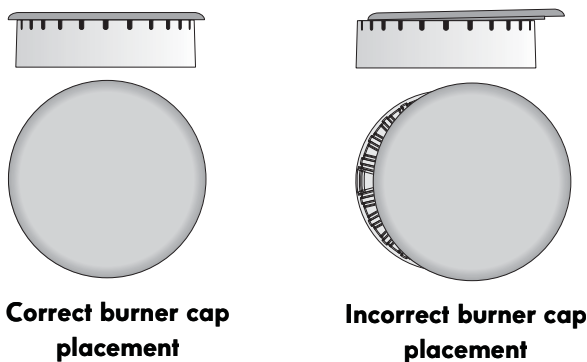

Figure 6: Burner cap placement

Once in place, you may check the fit by gently sliding the burner cap from side to side to be sure it is centered and firmly seated (See Figure 7). When the burner cap lip makes contact inside the center of the burner head you will be able to hear the burner cap click. Please note that the burner cap should not move off the center of the burner head when sliding from side to side.

Check and be sure that all oval style (some models) burner caps are correctly in place on oval burner heads.

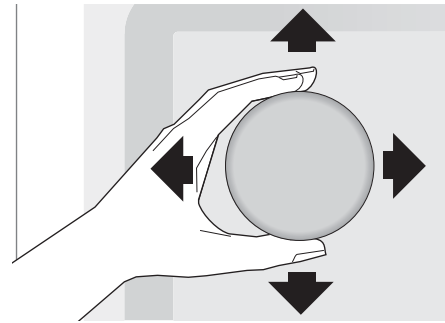

Figure 7: Checking the fit

## Installing Burner Grates

**⚠ CAUTION** Surface elements may appear to have cooled after they have been turned off. The surface element may still be hot and burns may occur if the surface element is touched before it has cooled sufficiently.

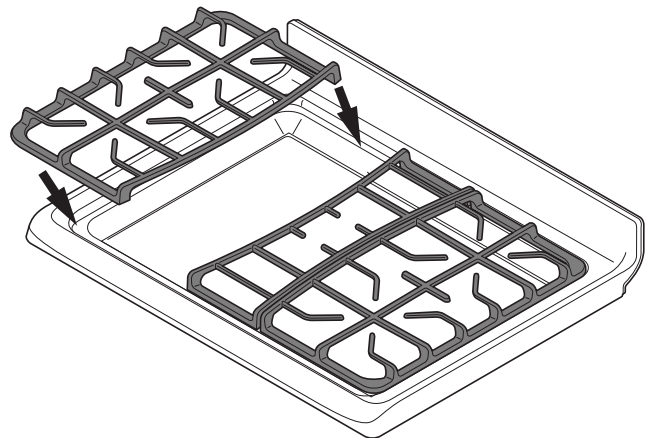

Figure 8: Burner grates placement

Make sure the burner grates are properly placed on the cooktop before using the surface burners. The grates are designed to rest inside the recess on the cooktop.

To install burner grates, place grates flat-side down and align into the cooktop recess. Grates should rest flush against each other and against the sides of the recess (See Figure 8).

## Using Proper Cookware

**⚠ CAUTION** Do not place flammable items such as plastic salt and pepper shakers, spoon holders or plastic wrappings on the cooktop when it is in use. These items could melt or ignite. Potholders, towels or wooden spoons could catch fire if placed too close to the range cooktop.

### Important:

Do not place aluminum foil, or any material that can melt on the range cooktop. If these items melt they may damage the cooktop.

For best cooking results, cookware should have flat bottoms that rest level on the surface burner grate. Before using cookware, check for flatness by rotating a ruler across the bottom of the cookware (See [Figure 9](#)).

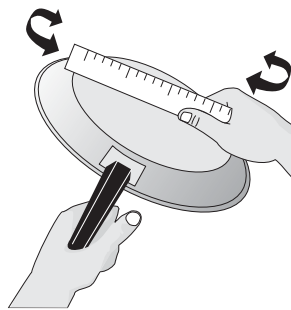

Figure 9: Testing cookware

### Important:

The size and type of utensil used, and the amount and type of food being cooked will influence the burner flame setting needed for best cooking results.

## Cookware Material Types

The cookware material determines how evenly and quickly heat is transferred from the surface element to the pan bottom. The most popular materials available are:

**Aluminum** - Excellent heat conductor. Some types of food will cause it to darken (Anodized aluminum cookware resists staining and pitting).

**Copper** - Excellent heat conductor but discolors easily (See Aluminum).

**Stainless** - Slow heat conductor with uneven cooking results. Is durable, easy to clean and resists staining.

**Cast Iron** - A slow heat conductor however will retain heat very well. Cooks evenly once cooking temperature is reached.

**Porcelain-enamel on metal** - Heating characteristics will vary depending on base material.

**Glass** - Slow heat conductor.

## Setting Proper Burner Flame Size

**⚠ CAUTION** Never extend the flame beyond the outer edge of the cooking utensil. A higher flame wastes energy, and increases your risk of being burned by the flame.

The color of the flame is the key to proper burner adjustment. A good flame is clear, blue and hardly visible in a well-lighted room. Each cone of flame should be steady and sharp. Adjust or clean burner if flame is yellow-orange.

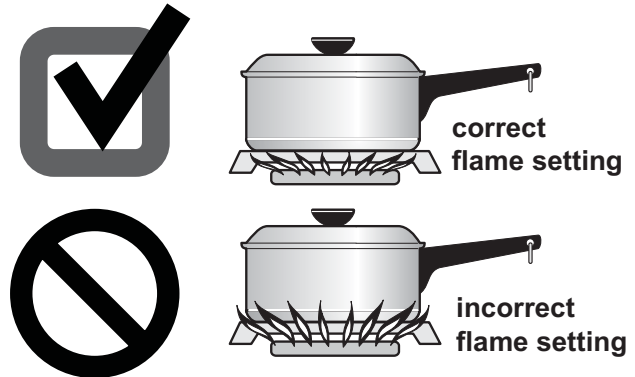

Figure 10: Correct and incorrect flame settings

For most cooking: start on the highest setting and then turn to a lower setting to complete the process. Use the recommendations in [Table 1](#) as a guide for determining proper flame size for various types of cooking.)

For deep fat frying: use a thermometer and adjust the surface knob accordingly. If the fat is too cool, the food will absorb the fat and be greasy. If the fat is too hot, the food will brown so quickly that the center will be under cooked. Do not attempt to deep fat fry too much food at once as the food will neither brown or cook properly.

Table 1: Flame size recommendations

Flame Size*	Type of Cooking
High flame	Start most foods; bring water to a boil; pan broiling
Medium flame	Maintain a slow boil; thicken sauces; gravies; steaming
Low flame	Keep foods cooking; poach; stewing

\*These settings are based for medium-weight metal or aluminum pans with lids. Settings may vary when using cookware made from different materials.

## **Home Canning**

**⚠ CAUTION** Canning can generate large amounts of steam. Use extreme caution to prevent burns. Always raise the lid to vent steam away from you. Safe canning requires that harmful micro-organisms are destroyed and the jars are sealed completely. When canning in a water bath canner, a gentle but steady boil must be maintained continuously for the required time.

Be sure to read and observe all the following points when home canning with your appliance. Check with the United States Department of Agriculture (USDA) Web site and be sure to read all the information they have available as well as follow their recommendations for home canning procedures.

- Use only quality flat bottom canners when home canning. Use a straight-edge to check canner bottom.
- Use only a completely flat bottom canner with no ridges that radiate from the bottom center when home canning. Heat is spread more evenly when the bottom surface is flat.
- Make sure the diameter of the canner does not exceed 1 inch beyond the surface element markings or burner. It is recommended to use smaller diameter canners on electric coil and ceramic glass cooktops and to center canners on the burner grates.
- Start with hot tap water to bring water to boil more quickly.
- Use the highest heat setting when first bringing the water to a boil. Once boiling is achieved, reduce heat to lowest possible setting to maintain that boil.
- Use tested recipes and follow instructions carefully. Check with your local Cooperative Agricultural Extension Service or a manufacturer of glass jars for the latest canning information.
- It is best to can small amounts and light loads.
- Do not leave water bath or pressure canners on high heat for an extended amount of time.
- Alternate surface units between each batch to allow the units and surrounding surfaces to cool down. Try to avoid canning on the same burner unit all day.

# Setting Surface Controls

## Setting Surface Burners

Your gas appliance may be equipped with different sized surface burners. The ability to heat food quicker and in larger volumes increases as the burner size increases. It is important to select cookware that is suitable for the amount and type of food being prepared.

The smaller **SIMMER** burner (on some models) is best suited for simmering delicate sauces, etc.

The standard size burners may be used for most surface cooking needs. Some models are equipped with a center burner.

The larger **POWER** burners (on some models) or **TURBO BOIL** burner (on some models) are recommended for bringing large quantities of liquid to temperature and when preparing larger quantities of food.

### To set surface burners:

**⚠ CAUTION** Do not place flammable items such as plastic salt and pepper shakers, spoon holders or plastic wrappings on the cooktop when it is in use. These items could melt or ignite. Potholders, towels or wooden spoons could catch fire if placed too close to the range cooktop.

**⚠ CAUTION** Do not place aluminum foil, or any material that can melt on the range cooktop. If these items melt they may permanently damage the cooktop surface.

**⚠ CAUTION** When operating the oven, it is possible for residual heat from the oven to build-up and over time to eventually transfer to the surface control knobs located directly above the oven door.

1. Place cooking utensil on center of surface burner grate. Be sure the cooking utensil sets stable on the burner grate.
2. Push the desired surface control knob in and turn counterclockwise out of the OFF position (See [Figure 11](#)).
3. Release the surface control knob and rotate to the LITE position. Visually check that the burner has lit.
4. Once the burner has a flame, push the control knob in and turn counterclockwise to the desired flame size. Use the control knob markings and adjust the flame as needed.

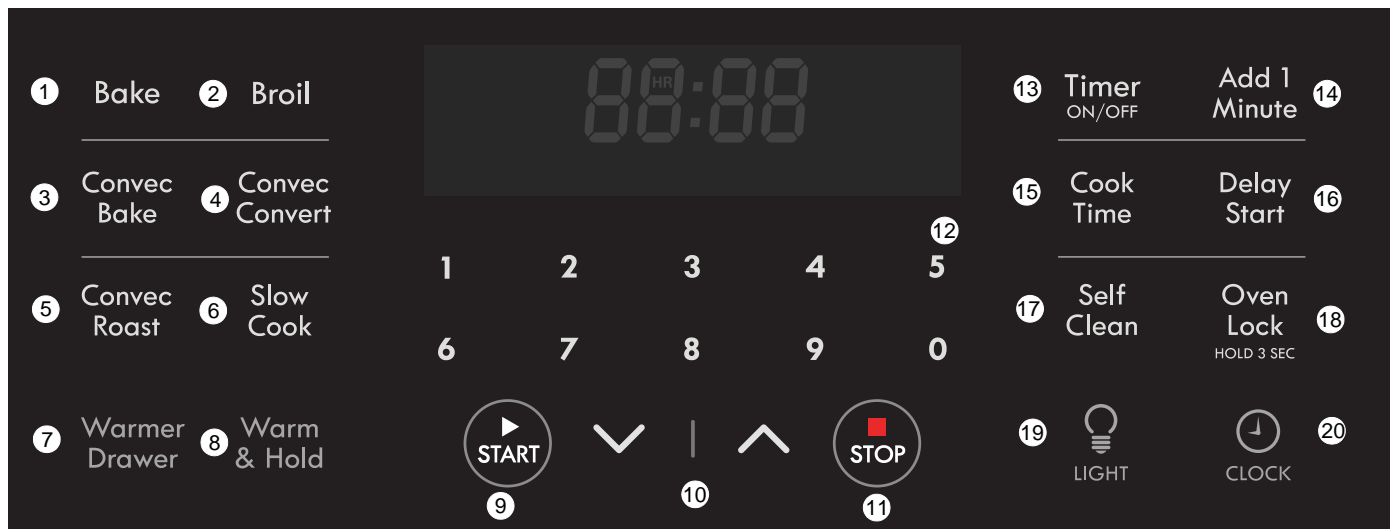

Figure 11: Surface control knob

### Important notes:

- Do not cook with the surface control knob left in the LITE position. The electronic ignitor will continue to spark if the control knob setting remains in the LITE position.
- When setting any surface control knob to the LITE position, all electronic surface ignitors will spark at the same time. However, only the surface burner you are setting will ignite.
- Never place or straddle a cooking utensil over two different surface cooking areas at the same time. This can cause uneven heating results.
- In the event of an electrical power outage, the surface burners can be lit manually. Use caution when lighting surface burners manually. To light a surface burner, hold a lit match to the burner head, then slowly turn the surface control knob to LITE. After burner lights push in and turn knob to desired setting.

# Oven Controls



1. **Bake** - Use to start a normal Bake function.
2. **Broil** - Use to select Broil function.
3. **Convec Bake** - Use to select Conv Bake function.
4. **Convec Convert** - Use to select Conv Convert function.
5. **Convec Roast** - Use to select Conv Roast function.
6. **Slow Cook** - Use to select Slow Cook function.
7. **Warmer Drawer** - Use to select warmer drawer function.
8. **Warm & Hold** - Use to keep cooked food warm and at serving temperature for up to 3 hours.
9. **START** - Use to start oven functions.
10. **Up / Down** arrows - Use with the function keys to adjust settings and adjust temperature and times.
11. **STOP** - Use to cancel any oven function previously entered except clock and timer.
12. **0-9 keypad** - Use to enter oven temperatures and times.
13. **Timer ON/Off** - Use to set and cancel the timer.
14. **Add 1 Minute** - Use to add one minute to the timer. This works with the kitchen timer and does not affect any cook time or start time functions.
15. **Cook Time** - Use to set a specific amount of time needed for cooking. Automatically cancels cooking process at end of set time.
16. **Delay Start** - Use with Bake, Conv Bake, Conv Concert, and Self Clean functions to program a delayed start time.
17. **Self Clean** - Use to select 2, 3, or 4 hr Self-Clean cycle.
18. **Oven Lock** - Use to lock oven door and oven functions.
19. **LIGHT** - Use to turn internal oven light on and off.
20. **CLOCK** - Use to set time of day.

## Minimum and Maximum Control Settings

All of the features listed have minimum and maximum time and temperature settings that may be entered into the control. An entry acceptance beep will sound each time a key is touched. An entry error tone (three short beeps) will sound if the entry of the temperature or time is below the minimum allowable setting or above the maximum setting for the cooking feature. The error tone will also sound any time a key is pressed if the entry is determined to be an invalid selection.

### Important note:

The oven control works with both the numeric keypad and the Up / Down arrow keys. For cooking functions (Bake, Broil, Convec Bake, Convec Convert, Convec Roast, and Slow Cook) as well as for the Timer ON/OFF and the CLOCK functions, you may press the **Up / Down arrows** to adjust the temperature in addition to (or instead of) using the digital keys. Regardless of the method you choose, always press the **START** key to start the desired function.

Please be aware that the Up / Down arrow keys will not operate with the following functions: Warmer Drawer, Add 1 Minute, and Warm & Hold. If an arrow key is pressed in an attempt to program any given function that is invalid, the control will sound a triple beep.

Table 2: Minimum and maximum control settings

Feature	Min. Temp or Time	Max. Temp or Time
Bake	170°F (77°C)	550°F (288°C)
Broil	400°F (205°C)	550°F (288°C)
Timer	1 minute	11 hrs. 59 mins.
Self Clean	2 Hours	4 Hours
Warm & Hold	170°F (77°C)	3 Hours
Cook Time	1 Minute	11:59
Delay Time 12 Hr.	1:00	12:59
Delay Time 24 Hr.	0:00	23:59
Convec Bake	170°F (77°C)	550°F (288°C)
Convec Convert	170°F (77°C)	550°F (288°C)
Convec Roast	170°F (77°C)	550°F (288°C)
Clock 12 Hr.	1:00	12:59
Clock 24 Hr.	0:00	23:59
Slow Cook	LO 225°F (77°C)	HI 275°F (134°C)



### Setting Clock

When the appliance is first powered up, **12:00** will flash in the display (See [Figure 12](#)). The time of day must first be set before operating the oven.



Figure 12: 12:00 in display before setting the clock

To set clock to 1:30:

1. Press .
2. Enter **1 3 0** using numeric keypad or press the **Up / Down arrow** keys until 130 appears in the display.
3. Press .

### Important note:

The clock cannot be changed when a Cook Time, Self Clean, Delay Start, or cooking feature is active.

### Setting Timer

The minute timer allows you to track your cooking times without interfering with the cooking process. The timer may be set from a minimum time of 1 minute to a maximum of 11 hours and 59 minutes.

To set timer for 5 minutes:

1. Press **Timer ON/OFF**.
2. Enter **5** using numeric keypad or press the **Up arrow** key until **5** appears in the display.
3. Press  to start the timer. When set time ends, **END** will show in the display and the control will sound a beep three times every 30 seconds until **Timer ON/OFF** key is pressed.

To cancel the timer when active, press **Timer ON/OFF** again.

### Important note:

- The timer does not start or stop the cooking process. It serves as an extra minute timer that will beep when the set time has run out. The timer may be used alone or while using any of the other oven functions.
- When timer is set for more than 1 hour it will display hours and minutes until 1 hour remains. When less than 1 hour remains, the display counts down in minutes and seconds. With less than 1 minute remaining, only seconds will display.
- If the timer is active during a cooking process, the timer will show in the display. To view the status of any other active oven function, press the key of the cooking function once and it will appear in the display for a few seconds.

### Add 1 Minute

Use the Add 1 Minute feature to set additional minutes to the timer. Each press of the key will add 1 additional minute. If **Add 1 Minute** is pressed when the timer is not active, the timer will activate and begin counting down from 1 minute.

To add 2 minutes to the timer:

Press **Add 1 Minute** twice.

## Oven Controls

### Setting 12 Hour or 24 Hour Display Mode

The clock display mode allows you to select 12 hr or 24 hr modes. The factory pre-set clock display mode is 12 hours.

To set 12 hr or 24 hr display mode:



1. Press and hold  for 6 seconds.
2. Press the **Up / Down arrow** keys to toggle between **12 Hr day** or **24 Hr day** display modes (See [Figure 13](#)).
3. Press  to accept the choice.



Figure 13: 12 Hr dAY and 24 Hr dAY settings

### Changing Between Continuous Bake Setting or 12 Hour Energy Saving

The oven control has a factory preset built-in 12 Hour Energy Saving feature that will turn off the oven if the oven is left on for more than 12 hours. The control may be programmed to override this feature to bake continuously.

To change between continuous bake or 12 hour energy saving feature:

1. Press and hold **Timer ON/OFF** for 6 seconds
2. Press the **Up / Down arrow** keys to toggle between **12 Hour OFF** or **Stay On** feature (See [Figure 14](#)).
3. Press  to accept choice



Figure 14: 12 hr energy saving (L) and continuous setting (R)

### Changing Temperature Display to Fahrenheit (°F) or Celsius (°C)

The electronic oven control is set to display °F when shipped from the factory. The display may be changed to show either °F or °C oven temperatures.

To change temperature display mode from °F to °C or from °C to °F:

1. Press and hold **Broil** for 6 seconds.
2. Once **F** (or **C**) appears in the display, press the **Up / Down arrow** keys to toggle between Fahrenheit and Celsius temperature display modes (See [Figure 15](#)).
3. Press  to accept the choice.

**Important note:**

The oven temperature display cannot be changed during the cooking process or if a Delay Start has been set or Self Clean is active.



Figure 15: Display showing Fahrenheit and Celsius

### Setting Silent or Audible Control mode

Silent mode allows the oven control to operate without audible tones. The control may be programmed for silent operation and later reset to operate with all the normal audible tones.

To set for silent or audible mode:

1. Press and hold **Delay Start** for 6 seconds.
2. Press the **Up / Down arrow** keys to toggle between **bEEP On** or **bEEP OFF** (See [Figure 16](#)).
3. Press  to accept the choice.



Figure 16: Display showing audible and silent operation



## Setting Oven Lockout

The control may be programmed to lock the oven door and lock the oven control keys.

### To activate the oven lockout features:

1. Be sure oven door is completely closed.
2. Press and hold the **Oven Lock** key for 3 seconds. The motor driven door latch mechanism will begin locking the oven door automatically. Do not open the oven door. Allow about 15 seconds for the oven door to completely lock. Once door is locked, the word **DOOR** with a lock icon will appear in the display.

### To cancel the oven lockout feature:

1. Press and hold the **Oven Lock** key for 3 seconds. The motor door latch will begin unlocking the oven door automatically. Do not open the oven door. Allow about 15 seconds for the oven door to completely unlock.
2. When the word **DOOR** with a lock icon no longer displays, the oven door may be opened and the oven control keypad will be available for use.

### Important note:

- To avoid damage to the oven door latching mechanism, do not attempt to open or close the oven door whenever the word **DOOR** with a lock icon is displayed.
- If a control key is pressed when oven lockout is active, the control will triple beep indicating the key action is not available when the oven lockout feature is active.

## Operating Oven Lights

The interior oven lights will automatically turn on when the oven door is opened. Oven lights will not operate during a self clean cycle.

Press  to turn the interior oven lights on and off whenever the oven door is closed.

The interior oven lights are located on the rear wall of the oven interior and are covered with a glass shield. The glass shield protects the bulb from high temperatures and should always be in place whenever the oven is in use.

To replace the interior oven light, see [“Replacing Oven Light \(some models\)”](#) on [page 32](#).

## Oven Controls

### Setting Bake

Use the bake feature whenever the recipe calls for baking using normal temperatures. A reminder tone will sound indicating when the set bake temperature is reached and to place the food in the oven.

Bake may be set for any oven temperature between 170°F (77°C) to 550°F (288°C).

#### To set Bake for oven temperature of 425°F:

**⚠ CAUTION** Always use pot holders or oven mitts when using the oven. When cooking the oven interior, oven racks, and cooktop will become very hot which can cause burns.

1. Press **Bake**.
2. Enter **4 2 5** using numeric keypad or press the **Up arrow** key until **4 2 5** appears in the display.
3. Press **START**. The word **BAKE** will appear on the display.

To cancel Bake at any time, press **STOP**.

### Radiant bake rack positions:

- Fully preheat the oven before baking items like cookies, biscuits, and breads.
- When using any single rack, position the rack so that the food is in the center of the oven.
- When baking using two oven racks, position bakeware as shown in [Figure 17](#). Allow at least 2 inches (5 cm) of space between bakeware for proper air circulation.
- Dark or dull pans absorb more heat than shiny bakeware, resulting in dark or overbrowning of foods. It may be necessary to reduce the oven temperature or cook time to prevent overbrowning of some foods. Dark pans are recommended for pies. Shiny pans are recommended for cakes, cookies, and muffins.
- Glass cookware is a slow heat conductor. May require reducing oven temperature.
- Minimize opening of the oven door. Opening the door will reduce the temperature in the oven.
- For batter and dough-based baked goods such as cakes, pastries, and breads, use the regular bake function for best results.

### Important note:

The oven will bake no longer than 12 hours. If you wish to bake for a longer period, see [“Setting Cook Time”](#) on [page 19](#) for detailed information.

### Baking tips

- Fully preheat the oven before cooking items like cookies, biscuits, and breads.
- When using any single rack, position the rack so that the food is in the center of the oven.
- For best results when baking cakes or cookies using two oven racks, place racks in positions 3 and 5 (See [Figure 18](#)).
- Dark or dull bakeware absorbs more heat than shiny bakeware. It may be necessary to reduce oven temperature and cook time to prevent overbrowning of some foods. Dark bakeware is recommended for pies. Shiny bakeware is recommended for cakes, cookies, and muffins.
- For best results when baking cakes or cookies using two oven racks, place pans as shown in [Figure 17](#).

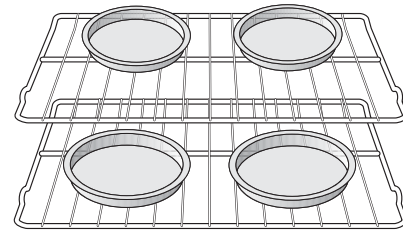

Figure 17: Baking on multiple levels

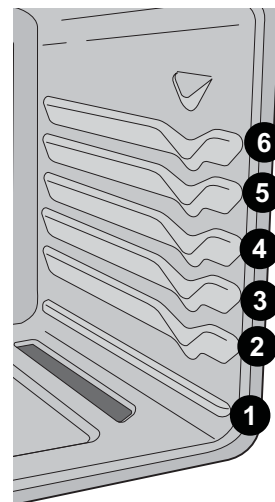



Figure 18: Oven rack positions

## Setting Cook Time

Use Cook Time to set the amount of time needed for baking. The oven will turn on immediately and stop automatically after the set cook time ends.

**To program oven to bake with oven default temperature of 350°F and to shut-off after 30 minutes:**

**⚠ WARNING** Food Poisoning Hazard. Do not let food sit for more than one hour before or after cooking. Doing so can result in food poisoning or sickness. Foods that can easily spoil such as milk, eggs, fish, meat, or poultry should be chilled in the refrigerator first. Even when chilled, they should not stand in the oven for more than 1 hour before cooking begins and should be removed promptly when finished cooking.

1. Press **Cook Time**.
2. Enter **3 0** using numeric keypad or press the **Up arrow** key until **3 0** appears in the display.
3. Press  to accept.
4. Press **Bake**.
5. Press . The word **BAKE** will appear on the display.

**When the programmed cook time ends:**

**End** will appear in the display window and the oven will shut-off automatically (See [Figure 19](#)). The oven control will beep three times every 30 seconds as a reminder until  is pressed.





**Figure 19: Display showing cooking has ended**

### Important note:

- The Cook Time feature may be set with Bake, Conv Bake, Conv Roast, and Slow Cook. Cook Time or Delay Start will not operate with the Broil function.
- The maximum Cook Time setting is 11 hours and 59 minutes unless oven is set for continuous cooking.

**To change the oven temperature or cook time after baking has started:**

1. Press **Bake** (for oven temperature) or **Cook Time**.

Press  or  and release when the desired temperature or cook time setting appears in the display. When the cook time runs out, **End** will appear in the display. The oven control will beep three times every minute until  is pressed.



## Setting Delay Start

Delay Start sets a delayed starting time to oven cooking or cleaning functions. Prior to setting a delay start, be sure the time of day is set correctly.

**To program oven for a Delay Start beginning at 5:30, to shut-off automatically after 50 minutes and for baking at 375°F:**

**⚠ WARNING** Food Poisoning Hazard. Do not let food sit for more than one hour before or after cooking. Doing so can result in food poisoning or sickness. Foods that can easily spoil such as milk, eggs, fish, meat, or poultry should be chilled in the refrigerator first. Even when chilled, they should not stand in the oven for more than 1 hour before cooking begins and should be removed promptly when finished cooking.

**⚠ CAUTION** Always use pot holders or oven mitts when using the oven. When cooking the oven interior, oven racks, and cook-top will become very hot which can cause burn

1. Press **Cook Time**.
2. Enter **5 0** using numeric keypad or press the **Up arrow** key until **5 0** appears in the display.
3. Press  to accept.
4. Press **Delay Start**.
5. Enter **5 3 0** using numeric keypad or press the **Up arrow** key until **5 3 0** appears in the display.
6. Press  to accept.
7. Press **Bake**.
8. Enter **3 7 5** using numeric keypad or press the **Up arrow** key until **3 7 5** appears in the display.
9. Press .

**When the programmed cook time ends:**

**End** will appear in the display window and the oven will shut off automatically (See [Figure 19](#)). The oven control will beep three times every 30 seconds as a reminder until  key is pressed.

### Important note:

Delay Start may be set using a 24 hr clock. To set clock for 24 Hr operation, see [“Setting 12 Hour or 24 Hour Display Mode”](#) on [page 16](#) for more information. The Delay Start feature may be used with Conv Bake, Conv Roast, Conv Convert, Bake, and Slow Cook functions and Self Clean. Delay Start or Cook Time will not operate with the Broil function.

## Oven Controls

### Convec Bake

Benefits of convection cooking include:

- Foods can cook up to 25 to 30% faster.
- Multiple rack baking.
- When using convection, use cookware or pans with low sides. This allows the air to circulate around the food evenly.

Convection functions use a fan to circulate the oven's heat uniformly and continuously around the oven. This improved heat distribution allows for fast, even cooking and browning results. It also gives better baking results when using two oven racks at the same time. Heated air flows around the food from all sides, sealing in juices and flavors. Breads and pastry brown more evenly. Most foods baked in a standard pan will cook faster and more evenly with the convection feature. Convec Bake may be set for any oven temperature between 300°F (148°C) and 550°F (288°C).

To set Convec. Bake with a default oven set temperature of 350°F:

1. Press **Conv Bake**.
2. Press .

To cancel Conv Bake at any time press .

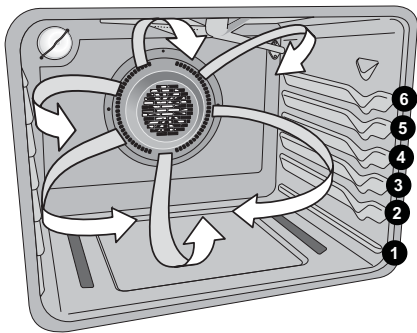

Figure 20: Air movement using convection

#### Important notes:

- The convection fan on a gas range will not begin rotating until Convec Bake has been into the cycle for six minutes.
- If the oven door is opened when Convec Bake is active, the convection fan will stop rotating until the oven door is closed.
- When using Convec Bake, cook time reductions may vary depending on the amount and type of food being cooked.

#### Suggestions for Convec Bake:

- For optimum cooking results, it is recommended to preheat the oven when baking foods such as cookies, biscuits, and breads.

- Reduce oven temperature 25°F from recipe's recommended oven temperature. Follow the remainder of the recipe's instructions using the minimum recommended cook time.
- For best results when using a single oven rack, place rack in position 2 or 3 (See [Figure 20](#)). When using two oven racks, place in positions 1 and 4. When using three oven racks, place in positions 1, 3, and 6 (use offset rack only in position 6).
- Dark or dull pans absorb more heat than shiny bakeware resulting in dark or overbrowning of foods. It may be necessary to reduce the oven temperature or cook time to prevent overbrowning of some foods. Dark pans are recommended for pies. Shiny pans are recommended for cakes, cookies, and muffins.

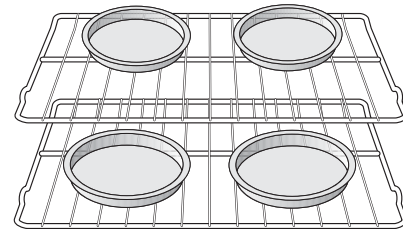

Figure 21: Baking on multiple levels

#### Baking tips

- Fully preheat the oven before cooking items like cookies, biscuits, and breads.
- When using any single rack, position the rack so that the food is in the center of the oven.
- For best results when baking cakes or cookies using two oven racks, place racks in positions 3 and 5 (See [Figure 20](#)).
- Dark or dull bakeware absorbs more heat than shiny bakeware. It may be necessary to reduce oven temperature and cook time to prevent overbrowning of some foods. Dark bakeware is recommended for pies. Shiny bakeware is recommended for cakes, cookies, and muffins.
- Use cookware or pans with low sides. This allows the air to circulate around the food evenly.
- Glass cookware may require reduced temperatures.

## Setting Conv Roast

The Conv Roast function combines a cook cycle with the convection fan to roast meats and poultry. Meats cooked using the Conv Roast function will be juicier, and poultry will be crisp on the outside while staying tender and moist on the inside.

Conv Roast may be set for any oven temperature between 170°F (77°C) and 550°F (288°C).

### Suggestions for Conv Roast:

- Preheating is not necessary when roasting foods using Conv Roast. Since Conv Roast cooks food faster, reduce the cook time by 25% from the recommended cook time of your recipe. If necessary, increase cooking time until the desired doneness is obtained.
- The broiler pan will catch grease drippings, and the grid will help prevent splatters. The roasting rack will hold the meat. Use the offset rack on rack position 1.
- Do not cover foods when dry roasting because this will prevent the meat from browning properly.

### To set Conv Roast with a default oven set temperature of 350°F:

1. Press Conv Roast.
2. Press .

To cancel Conv Roast at any time press .

### Important note:

- After 6 minutes, the convection fan will begin rotating once Conv Bake, Conv Roast, or Conv Convert has been activated.
- If the oven door is opened when any convection function is active, the convection fan will stop rotating until the oven door is closed.
- It is not recommended to roast chicken on a roasting rack. Use a deep pan instead.

## Setting Conv Convert

Pressing the Conv Convert key automatically converts the cooking temperature entered for any standard baking recipe to the lower temperature required for convection baking.

When Conv Convert is used with a timed Conv Bake setting of 20 minutes or more, the Conv Convert function will display a **CF** message as a reminder to check food when the bake time is 75% complete (See [Figure 22](#)). At this time the oven control will sound one long beep at regular intervals until the set cook time has finished.





Figure 22: Check Food reminder shown in display.

### To add Conv Convert to Conv Bake function using default oven set temperature of 350°F:

1. Press **Conv Bake**.
2. Press **Conv Convert**.



To cancel Conv Convert at any time, press .

### To program oven for Conv Convert with oven default temperature of 350°F and to shut-off after 30 minutes:

1. Press **Conv Bake**.
2. Press  to accept.
3. Press **Cook Time**.
4. Enter **3 0** using numeric keypad or press the **Up arrow** key until **3 0** appears in the display.
5. Press .
6. Press **Conv Convert**.

To cancel Conv Convert at any time, press .

### To program oven for Conv Convert with recipe temperature of 425°F and to shut-off after 30 minutes:

1. Press **Conv Bake**.
2. Enter **4 2 5** using numeric keypad or press the **Up arrow** key until **4 2 5** appears in the display.
3. Press  to accept.
4. Press **Cook Time**.
5. Enter **3 0** using numeric keypad or press the **Up arrow** key until **3 0** appears in the display.
6. Press .
7. Press **Conv Convert**. Set bake temperature will convert to a lower temperature and begin baking process.

To cancel Conv Convert at any time press .

### Important note:

- Conv Convert may only be used with the Conv Bake function and with a minimum of 20 minutes cook time.
- When using Conv Convert feature, Cook Time reductions may vary depending on the oven set temperature.
- The convection fan will begin rotating once Conv Bake, Conv Roast, or Conv Convert has been activated.
- If the oven door is opened when any convection function is active, the convection fan will stop rotating until the oven door is closed.



## Oven Controls

### Setting Broil

Use the Broil function to cook meats that require direct exposure to radiant heat for optimum browning results. The Broil feature is factory preset to broil at 550°F. The Broil function temperature may be set at any temperature between 400°F (205°C) and 550°F (288°C).

The suggested broil settings are recommendations only (See Table 3). Depending on cooking preferences, you can increase or decrease cooking times or move food to a different rack position. If the food you are broiling is not listed in the table, follow the instructions provided in your cookbook and watch the item closely.

#### To set Broil with the default broil oven temperature of 550°F:

1. Arrange the oven racks when cool. For optimum browning results, preheat oven for 5 minutes before adding food.
2. Position bakeware in oven to the preferred rack position (See Figure 24).
3. Press **Broil**.
4. Press . To set to a lower broil temperature, press and hold the **Down arrow** key until the desired temperature is reached. The lowest setting the oven control will accept for Broil is 400°F. To adjust the Broil temperature, press **Broil** again and then the **Up or Down** arrow key to set the desired temperature.
5. Broil on one side until food is browned; turn an broil other side until done to your satisfaction.
6. When finished broiling, press .
7. To cancel Broil at any time, press **STOP**.

**CAUTION** Always use pot holders or oven mitts when using the oven. When cooking, the oven interior, oven racks, and cook-top will become very hot which can cause burns.

**WARNING** Should an oven fire occur, close the oven door and turn the oven off. If the fire continues, use a fire extinguisher. Do not put water or flour on fire. Flour may be explosive.

#### Important notes:

- Always arrange oven racks when the oven is cool.
- For best results when broiling, use a broil pan with broil pan insert designed to drain the fat from the food and help avoid spatter and reduce smoking. To purchase them, call Sears at 1-800-4-MY-HOME (1-800-4663) and order broil pan kit 5304442087.
- When broiling, always pull the oven rack out to the stop position before turning or removing food.

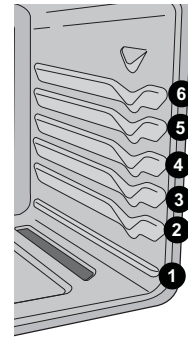
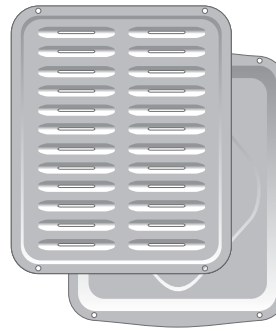

Figure 23: Broiler pan/insert

Figure 24: Rack positions

Table 3: Suggested Broil Settings<sup>1</sup>

Food	Rack Position	Setting	Cook time in minutes		Doneness
			1st side	2nd side	
Steak, 1 inch thick	6th	550°F	8	6	Medium
Steak, 1 inch thick	5th or 6th	550°F	10	8	Medium-well
Steak, 1 inch thick	5th or 6th	550°F	11	10	Well
Pork Chops, 3/4 inch thick	5th	550°F	12	8	Well
Chicken, bone-in	5th	450°F	25	15	Well
Chicken, boneless	5th	450°F	10	8	Well
Fish	5th	550°F	as directed		Well
Shrimp	4th	550°F	as directed		Well
Hamburger, 1 inch	5th or 6th	550°F	12	10	Medium

1. For steaks, cook times are suggestions and should only be used as a guide.

## Setting Slow Cook

The Slow Cook feature cooks foods more slowly and at lower oven temperatures for longer periods of time. Slow Cook is ideal for roasting beef, pork and poultry. Slow cooking meats may result in the exterior of meats becoming dark but will not burn the outside as it seals in the meat's juices.

Two Slow Cook settings are available: high (Hi) and low (Lo). The high setting is best for cooking foods between 4 and 5 hours. The low setting is best for cooking foods up to 9 hours or longer.

### Some tips for best results when using Slow Cook:

- Completely thaw all frozen foods before cooking.
- When using a single oven rack, place in oven rack position 2 or 3. Position racks to accommodate the size of various bakeware when cooking multiple food items.
- Do not open the oven door often or leave the door open when checking foods. If the oven heat escapes often, the Slow Cook time may need to be extended.
- Cover to keep foods moist or use a loose or vented type cover to allow foods to turn crisp or brown.
- Roasts may be left uncovered so browning can occur. Cook times will vary depending on the weight, fat content, bone, and the shape of the roast. Preheating the oven will not be necessary when using the Slow Cook feature.
- Add any cream or cheese sauces during the last hour of cooking.

### Important note:

- Slow Cook may be used with additional settings of Cook Time and Delay Start.
- The maximum cook time for Slow Cook function is 11 hours and 59 minutes unless the control has been changed to the continuous bake mode.

### To set Slow Cook:

**⚠ WARNING** Food poisoning hazard. Do not let food sit for more than one hour before or after cooking. Doing so can result in food poisoning or sickness. Foods that can easily spoil such as milk, eggs, fish, meat or poultry, should be chilled in the refrigerator first. Even when chilled, they should not stand in the oven for more than 1 hour before cooking begins, and should be removed promptly when finished cooking.

1. Position bakeware in oven and close oven door.
2. Press **Slow Cook**. **HI** will appear in the display, indicating the default temperature setting is for high.
3. If a low setting is needed, press **Slow Cook** again or press the **Down arrow** key to select the low setting.
4. Press  to activate Slow Cook.

To cancel Slow Cook at any time, press .

## Warm & Hold™

Warm & Hold should only be used with foods that are already at serving temperatures. Warm & Hold will keep cooked foods warm and ready for serving for up to 3 hours after cooking has finished. After 3 hours the Warm & Hold will shut-off automatically. Warm & Hold will keep the oven temperature at 170° F (77°C).



### To set Warm & Hold:

1. If needed, arrange oven racks and place cooked food in oven.
2. Press **Warm & Hold**. **Hold WARM** will appear in the display. (If no other keys are touched within 25 seconds the request for Warm & Hold will clear.)
3. Press . Warm & Hold will automatically turn on and then turn off after 3 hours unless cancelled.

To turn Warm & Hold off at any time, press .

### To add Warm & Hold to turn ON after baking 45 minutes with a set temperature of 425°F:

**⚠ WARNING** Food poisoning hazard. Do not let food sit for more than one hour before or after cooking. Doing so can result in food poisoning or sickness. Foods that can easily spoil such as milk, eggs, fish, meat or poultry, should be chilled in the refrigerator first. Even when chilled, they should not stand in the oven for more than 1 hour before cooking begins, and should be removed promptly when finished cooking.

1. Press **Cook Time**.
2. Enter **4 5** using numeric keypad.
3. Press .
4. Press **Bake** and enter **425** on numeric keypad.
5. Press  to accept.
6. Press **Warm & Hold**. **Hold WARM** will appear in the display.
7. Press  to accept. When the cook time is over, Warm & Hold will automatically turn on. The Warm & Hold function will automatically turn off after 3 hours.

### Important note:

- Warm & Hold will maintain the oven temperature at 170° F (77°C) for 3 hours.
- Warm & Hold may be set when finished cooking or may be added to automatically turn on after cooking using Cook Time. Delay Start may also be added.

## Oven Controls

### Setting the Sabbath feature (for use on the Jewish Sabbath and Holidays)

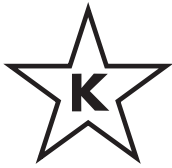

For further assistance, guidelines for proper usage, and a complete list of models with the Sabbath feature, please visit the web at [www.star-k.org](http://www.star-k.org).

This appliance provides special settings for use when observing the Jewish Sabbath/Holidays. Sabbath mode disables all audible tones or visual display changes on the oven control. Bake heating is the only cooking feature available while in the Sabbath mode. Oven controls are locked during Sabbath mode.

You must first set the Bake feature and temperature(s) needed for the oven, the Cook Time, and the Delay Start options (if needed). Any settings made prior to setting the Sabbath mode will be visible in the displays. The Cook Time option, if set prior to the Sabbath mode, will give one audible alert at the end of Cook Time.

The Sabbath mode will override the factory preset 12 hour energy saving mode, and the appliance will stay on until the cooking features are cancelled. If any of the cooking features are cancelled when the appliance is in the Sabbath mode, no audible or visual indicators will be available to verify the cancellation.

If the oven interior lights are needed, be sure to activate them prior to setting the Sabbath mode. Once the oven light is turned on and the Sabbath mode is active, the oven light will remain on until the Sabbath mode is turned off and the oven lights are turned off. The oven door will not activate the interior oven lights when the oven door is opened or closed.

It is recommended that any oven temperature modification made within an active Sabbath mode be followed with two presses of the **START** key. This will insure the oven remains on even if an attempt is made to set the oven temperature outside of its temperature range. If the oven temperature is set outside of the temperature range, the oven will default to the nearest available temperature. Try to set the desired oven temperature again.

**⚠ WARNING** Food poisoning hazard. Do not let food sit for more than one hour before or after cooking. Doing so can result in food poisoning or sickness. Foods that can easily spoil such as milk, eggs, fish, meat or poultry, should be chilled in the refrigerator first. Even when chilled, they should not stand in the oven for more than 1 hour before cooking begins, and should be removed promptly when finished cooking.

To program oven to Bake with default oven temperature of 350°F and activate the Sabbath feature:





1. Be sure the clock is set with the correct time of day.
2. Arrange oven racks, place bakeware in oven, and close oven door.
3. Press **Bake**.
4. Press .
5. If Cook Time or Delay Start are not needed, skip this step and continue to step 6. If a Cook Time or Delay Start are desired, enter the times at this point. Refer to the “[Setting Cook Time](#)” and “[Setting Delay Start](#)” on [page 19](#) for detailed instructions.
6. Press and hold **Cook Time** and **Delay Start** simultaneously for about 3 seconds to set the Sabbath feature. Once the feature is set, **SAb** will appear in the display indicating the oven is properly set for the Sabbath feature (See [Figure 25](#)).



Figure 25: Oven set for Sabbath baking.

#### Important note:

- Do not attempt to activate any other oven function except Bake while the Sabbath feature is active. The following keys will function correctly when the Sabbath feature is active: 0-9 number keypad, Bake, , and . All other keys should not be used once the Sabbath feature is active.
- You may change the oven temperature once baking has started. Press **Bake**, use the numeric keypad to enter the oven temperature change (170°F to 550°F), and press  (for Jewish Holidays only).
- Remember that the oven control will no longer provide audible tones or display any further changes when the Sabbath feature is active.
- Remember the oven will shut-off automatically after completing a Cook Time, Delay Start, or Warm & Hold and therefore may only be used once during the Sabbath/Jewish Holidays.
- If a Delay Start time longer than 11 hours and 59 minutes is desired, set the oven control for the 24 hour day display mode setting. For detailed instructions see “” on [page 16](#).



**To turn the oven off and keep the Sabbath feature active:**

Press .

**To turn off the Sabbath feature:**

Press and hold both **Cook Time** and **Delay Start** simultaneously for at least 3 seconds to turn the Sabbath feature off. The control will provide an acceptance tone, and **SAb** will disappear from the display. The oven is no longer programmed for the Sabbath feature.

**What to do during a power failure or power interruption after the Sabbath feature was activated:**

Should you experience a power failure or interruption, the oven will shut-off. When power is restored the oven will not turn back on automatically. The oven will remember that it is set for the Sabbath, and the oven display will show the message **SF** for Sabbath failure (See [Figure 26](#)).



**Figure 26: Display showing Sabbath failure**

The food may be safely removed from the oven while still in the Sabbath feature, however the oven cannot be turned back on until after the Sabbath/Holidays. After the Sabbath observance, turn off the Sabbath feature. Press and hold both **Cook Time** and **Delay Start** keys for at least 3 seconds simultaneously to turn the Sabbath feature off. **SF** will disappear from the display, and the oven may be used with all normal functions.

**Adjusting Oven Temperatures**

Your appliance has been factory calibrated and tested to ensure accurate baking temperatures. For the first few uses, follow your recipe times and temperature recommendations carefully. If you think the oven is cooking too hot or too cool for your recipe times, you may adjust the control so the oven cooks hotter or cooler than the oven temperature displayed.

The oven temperature may be increased as much as +35°F (+19°C) or decreased -35°F (-19°C) from the factory calibrated settings.

**To increase (+) or decrease (-) the oven temperature by 20°F:**

1. Press and hold **Bake** until the control produces an audible tone (about 6 seconds). The factory offset temperature of 0 (zero) should appear in the display.
2. Enter **2 0** using numeric keypad.
3. To offset the oven temperature by -20°F, press the Down arrow key until the display reads **-20**.
4. Press  to accept change.

**Important note:**

- Oven temperature adjustments will not change the Broil or Self Clean function temperatures.
- Do not use oven thermometers such as those found in grocery stores to check the temperature settings inside your oven. These oven thermometers may vary as much as 20 to 40°F degrees from actual temperatures.
- The oven temperature adjustment may be made if your oven control is set to display temperatures in °C (Celsius). Minimum and maximum settings for Celsius range from plus (+)19°C to minus (-) 19°C.

**Restoring Factory Default Settings**

Your appliance was set with predetermined (default) oven control settings. Over time, users may have made changes to these settings. The following options may have been modified since the appliance was new:

- 12 or 24 hr display mode
- Continuous bake or 12 hour energy savings mode
- Silent or audible control
- Oven temperature display (Fahrenheit or Celsius)
- Oven temperature adjustments (UPO)

**To restore oven control to factory default settings:**

**⚠ CAUTION** If you choose to restore any of the options to a factory default setting using this method, all of the above user settings will be restored to the factory default settings. This includes the oven temperature offset that will reset to (0) zero.

1. Press and hold **7** on numeric keypad until acceptance tone sounds (about 6 seconds).
2. Press . The control has been reset with the default settings.

## Oven Controls

### Warmer Drawer

#### Warm & Ready™ Drawer

The purpose of the warmer drawer is to keep hot cooked foods at serving temperatures. Examples are vegetables, gravies, meats, casseroles, biscuits, rolls, and pastries. It is not recommended to heat cold food in the warmer drawer; always start with hot food.

The warmer drawer may also be used to warm dinner plates. All food placed in the warmer drawer should be covered with a lid or aluminum foil to maintain quality.

#### Important note:

Do not use plastic wrap to cover food. Plastic may melt onto the drawer and be very difficult to clean up. Use only utensils and cookware recommended by the manufacturer for use in the keep warm drawer.

#### Arranging Warmer Drawer Rack Positions

**⚠ WARNING** Storage In or On Appliance—Flammable materials should not be stored in an oven, near surface units or in the storage drawer, warmer drawer or lower oven. This includes paper, plastic, and cloth items, such as cookbooks, plastic ware, and towels, as well as flammable liquids. Do not store explosives, such as aerosol cans, on or near the range.

**⚠ WARNING** Do Not Leave Children Alone - Children should not be left alone or unattended in the area where appliance is in use. They should never be allowed to sit or stand on any part of the appliance, including the storage drawer, lower broiler drawer, warmer drawer, or lower double oven.

**⚠ CAUTION** Always use potholders or oven mitts when removing food from the warmer drawer as cookware and plates will be hot and you can be burned.

The keep warmer drawer rack may be used in two ways:

- In the upright position (See [Figure 27](#)) to allow low profile food items to be placed both under and on top of the rack (for example, rolls or biscuits on top of the rack and a casserole dish underneath).

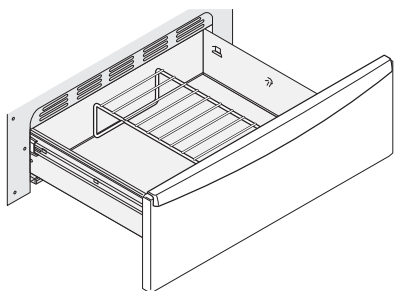

Figure 27: Upright position

- In the downward position (See [Figure 28](#)) to allow for light weight food items and empty cookware (for example, rolls, pastries, and dinner plates) on the rack.

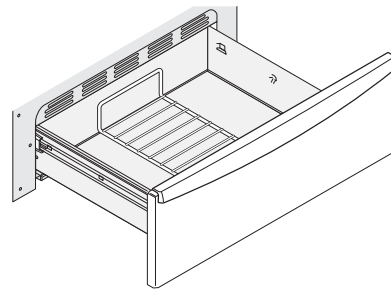

Figure 28: Downward position

#### Warmer Drawer Indicator Light

The indicator light is located above the warmer drawer thermostat control knob. It turns on when the control is set and stays on until the control is turned off.

#### Setting Warmer Drawer

##### To set warmer drawer:

**⚠ WARNING** Food Poisoning Hazard. Do not let food sit for more than one hour before or after cooking. Doing so can result in food poisoning or sickness. Foods that can easily spoil such as milk, eggs, fish, meat, or poultry should be chilled in the refrigerator first. Even when chilled, they should not stand in the oven for more than 1 hour before cooking begins and should be removed promptly when finished cooking.

**⚠ CAUTION** Always use potholders or oven mitts when removing food from the warmer drawer as cookware and plates will be hot and you can be burned.

1. Open warmer drawer when cool and arrange warmer drawer rack as needed.
2. For best results, close the warmer drawer and preheat the drawer before adding food or plates. An empty warmer drawer will fully preheat in approximately 15 minutes.
3. Place food in warmer drawer that is already at serving temperature on warmer drawer rack. Dinner plates may be warmed also.
4. Press **Warmer Drawer**, and then press **START**. The drawer will heat to 195°F.
5. Always turn warmer drawer control off after use by pressing **Warmer Drawer**.

**Important notes:**

- Always start with hot food when using the warmer drawer. Do not heat cold food in the warmer drawer.
- Self Clean can not be set when the warmer drawer is active.
- The warmer drawer is equipped with a catch that may require extra force to open and close the drawer.

**Removing and Replacing the Warmer Drawer****To remove the warmer drawer:**

**⚠ WARNING** Electrical shock hazard can occur and result in serious injury or death. Disconnect appliance from electric power before cleaning and servicing the warmer drawer.

1. Turn power OFF to the appliance before removing the warmer drawer.
2. Open the warmer drawer completely.
3. On left warmer drawer rail, locate black release lever and press up with finger while pulling out slightly on the oven drawer handle. On right warmer drawer rail, locate black release lever and press down with finger while pulling out slightly on the warmer drawer handle (See Figure 29).

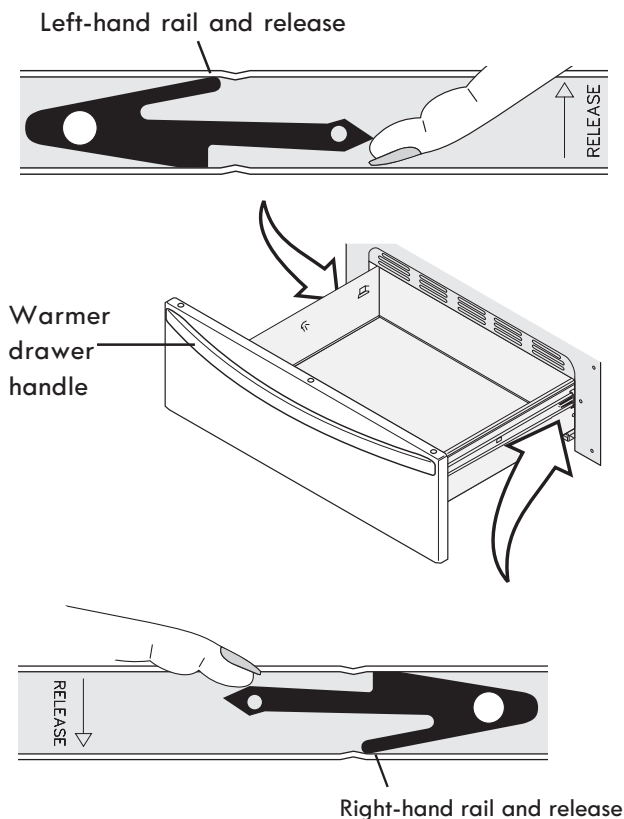
**Figure 29: Removing the warmer drawer**

4. The warmer drawer should now be released from the rails. Remove warmer oven drawer (using level and square motion) completely out and away from the appliance.

**To replace the warmer drawer:**

1. Pull the bearing glides to the front of the outer compartment glide channels until they snap into place (See Figure 30).

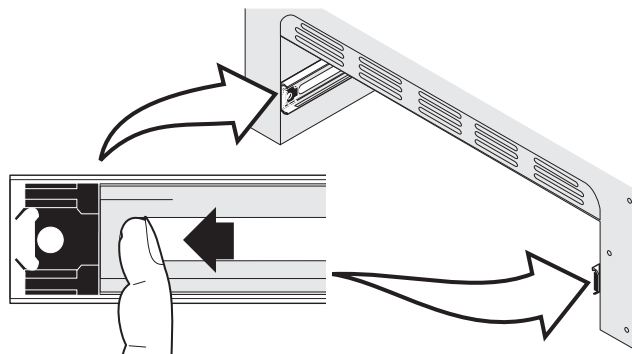
**Figure 30: Bearing glide placement**

2. Carefully line up both sides of the warmer drawer glide rails to the outer compartment glide channels located inside the empty warmer drawer compartment (See Figure 31).

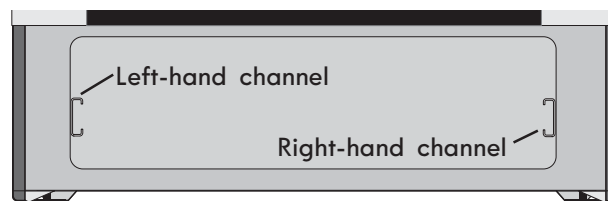
**Figure 31: Channel alignment**

3. While holding the warmer drawer level and square using the warmer drawer handle, push (do not force) the warmer drawer all the way into the outer compartment glide channels all the way into the range. Open the warmer drawer again to verify the glides have seated.
4. If you do not hear the levers "click" or the bearing glides do not feel seated remove the warmer drawer and repeat Steps 1 through 3 again. This will minimize possible damage to the bearing glides.

## Oven Controls

### Self Clean

A self cleaning oven cleans itself with high temperatures (well above normal cooking temperatures), which eliminate soils completely or reduces them to a fine powdered ash you can wipe away afterwards with a damp cloth.

The Self Clean function on this model can be programmed for any duration between 2 and 4 hours. Use numeric keypad or the **Up / Down arrow** keys. Each time an arrow key is pressed, the time is changed by 1 minute up or down. Press **START**.

**Read before starting Self Clean.** Be sure to read all following caution and important statements before starting a self clean cycle.

**⚠ CAUTION** Do not leave small children unattended near appliance. During self clean cycle, the outside of the oven can become very hot and cause burns if touched.

**⚠ CAUTION** Do not line the oven walls, racks, oven bottom, or any part of the range with aluminum foil. This will cause permanent damage to the oven interior and destroy heat distribution, and will melt to the oven interior.

**⚠ CAUTION** Do not force the oven door open. This will damage the automatic door locking system. Use caution when opening the oven door after the self clean cycle ends. The oven may still be very hot and cause burns. To avoid possible burns, stand to side of oven when opening door to allow steam or hot air to escape.

**⚠ CAUTION** The health of some birds is extremely sensitive to fumes given off during the self clean cycle of any range. Move birds to a well ventilated room.

#### Important notes:

- Completely remove all oven racks and any accessories from oven cavity to avoid damage to oven racks. If the oven racks are not removed they may discolor. Remove all items from the oven and cooktop including cookware, utensils, and any aluminum foil. Aluminum foil will not withstand high temperatures from a self clean cycle and will melt.
- Do not use oven cleaners or oven protective coatings in or around any part of the oven interior. Clean any soil from the oven frame, the door liner outside the oven door gasket, and the small area at the front center of the oven bottom (See [Figure 32](#)). These areas heat sufficiently to burn soil on. Clean using soap and water prior to starting Self Clean.

- Remove any excessive spills. Any spills on the oven bottom should be wiped up and removed before starting a Self Clean cycle. To clean use hot, soapy water and a cloth. Large spills can cause heavy smoke or fire when subjected to high temperatures. Do not allow food spills with high sugar or acid content (such as milk, tomatoes, sauerkraut, fruit juices, or pie fillings) to remain on the surface as they may leave a dull spot even after cleaning.

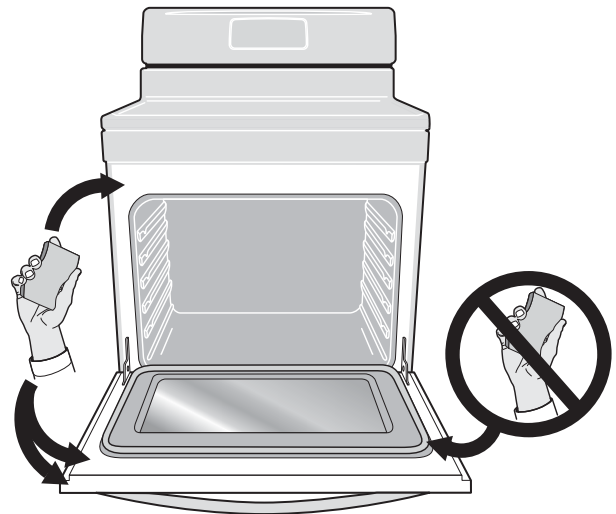

**Figure 32: Areas to clean and to avoid**

- Do not clean the oven door gasket. The woven material in the gasket is essential for a good seal. Care should be taken not to rub, damage, or remove the oven door gasket. Doing so could cause damage to the door gasket and compromise the performance of the oven.

#### Important notes:

- The kitchen area should be well ventilated using an open window, ventilation fan, or exhaust hood during the first Self Clean cycle. This will help eliminate the normal odors.
- Do not attempt to open the oven door when the OVEN LOCK indicator light is flashing. Allow about 15 seconds for the motorized door latch mechanism to completely lock or unlock the oven door.
- When the clean time finishes, the oven door will remain locked until the range has cooled sufficiently. In addition to the clean time that was programmed, you must allow about 1 additional hour for the oven to cool before you will be able to open the oven door.

## Setting Self Clean

### To set self clean:

1. Be sure the oven is empty and all oven racks are removed. Remove all items from the oven. Be sure oven door is completely closed.
2. Press **Self Clean** and the default 3 hour clean time will appear in the display. You may accept the default 3 hour clean time by going to step 3, or choose a different clean time. Press **Self Clean** and use the numeric keypad or **Up / Down arrow** keys to select any time between 2 hours and 4 hours. Once you have the desired clean time selected, proceed to Step 3.
3. Press  to activate Self Clean.

As soon as Self Clean becomes active, a motor driven lock mechanism will begin locking the oven door automatically. Do not attempt to open the oven door (allow 15 seconds for the lock mechanism to lock the oven).

Once the oven door has locked, **CLEAN** will appear in the display indicating Self Clean has started.



### When Self Clean is finished:

**CAUTION** Use caution when opening the oven door after self cleaning. The oven may still be very hot and can cause burns. To avoid possible burns stand to the side of the oven when opening the oven door to allow hot air or steam to escape.

1. **CLEAN** message will turn off, and **Hot** will appear in display window.
2. Once the oven has cooled down (about 1 hour) and **Hot** is no longer displayed, the oven door may be opened.
3. When the oven interior has completely cooled, wipe away any residue or powdered ash with a damp cloth or paper towel.

## Setting Delay Start Self Clean

### To start a delay Self Clean with default clean time of 3 hours and a start time of 9:00 o'clock:

1. Be sure the clock is set with the correct time of day, the oven is empty, and all oven racks are removed. Be sure oven door is completely closed.
2. Press **Delay Start**.
3. Using numeric keypad, enter **9 0 0** or press the **Up arrow** key until **9 0 0** appears in the display.
4. Press  to accept
5. Press **Self Clean**.
6. Press .

### If it becomes necessary to stop Self Clean when active:

1. Press .
2. If Self Clean has heated the oven to a high temperature, allow enough time for the oven to cool.
3. Before restarting Self Clean, be sure to read important notes below.

### Important note:

- If your clock is set with the (default) 12 hr display mode, the Delay Start for a Self Clean can only be programmed to start up to 11 hours and 59 minutes after the time showing in the display (be sure to set the clock to current time before programming a delay start). To set a Delay Start Self Clean to begin 12 or more hours (maximum is 23 hours and 59 minutes) after the time of setting, be sure to first set the control in the 24 Hr display mode.
- If Self Clean was active and then interrupted by a power failure or cancelled before the oven was thoroughly cleaned, it may be necessary to run another Self Clean cycle.
- If the oven temperature was high enough when Self Clean was interrupted the oven control may not allow another Self Clean cycle to be set for up to 4 hours.

# Care & Cleaning

Table 4: Cleaning recommendations

Surface Type	Recommendation
Control knobs Painted body parts Painted decorative trim Aluminum, plastic, or vinyl trim	For general cleaning, use hot, soapy water and a cloth. For more difficult soils and built-up grease, apply a liquid detergent directly onto the soil. Leave on soil for 30-60 minutes. Rinse with a damp cloth and dry. Do not use abrasive cleaners on any of these materials; they can scratch. To remove control knobs, turn to OFF position. Grasp firmly and pull straight off the shaft. To replace knobs after cleaning, line up the flat sides of both knob and shaft, then push knob into place.
Control panel Control keypad membrane Decorative trim (some models)	Before cleaning the control panel, turn all controls off, activate oven lockout (on some models), and if needed remove any knobs from panel. Do not use abrasive cleaners on any of these materials; they can scratch. Clean using hot, soapy water and a cloth or sponge. Be sure to squeeze excess water from cloth or sponge before wiping control panel, especially when wiping around the controls area. Excess water in or around the controls may cause damage to the appliance. When rinsing, use clean water and a cloth or sponge and be sure to squeeze excess water from cloth or sponge before wiping the control panel.
Porcelain enamel parts and door liner	Gentle scrubbing with a soapy non-abrasive scouring pad will remove most spots. Rinse with a 1:1 solution of clear water and ammonia. If necessary, cover difficult spots with an ammonia-soaked paper towel for 30 to 40 minutes. Rinse with clean water and a damp cloth, and then scrub with a soap-filled non-abrasive scouring pad. Rinse and wipe dry with a clean cloth. Do not allow food spills with high sugar or acid content (milk, tomatoes, sauerkraut, fruit juices, or pie filling) to remain on the surface; they may cause a dull spot even after cleaning.
Oven interior	For oven interior remove excessive spillovers from oven cavity bottom before starting Self Clean. Clean any soils from oven frame and door liner outside the oven door gasket. For very important cleaning precautions, be sure to read all the "Self Clean" instructions on <a href="#">page 28</a> .
Oven racks	Remove oven racks from oven cavity before starting Self Clean. Clean by using a mild, non-abrasive cleaner following manufacturer's instructions. Rinse with clean water, dry, and then replace in oven.
Oven door	Use soap and water to thoroughly clean the top, sides, and front of the oven door. Rinse well. You may use a glass cleaner on the outside glass of the oven door. Do not immerse the door in water. Do not spray or allow water or the glass cleaner to enter the door vents. Do not use oven cleaners, cleaning powders, or any harsh abrasive cleaning materials on the outside of the oven door.
Cooktop surface Surface burners Burner grates	Do not use spray oven cleaners on the cooktop. See " <a href="#">Cleaning the Cooktop and Surface Burners</a> " instructions on <a href="#">page 31</a> .
Stainless Steel (some models)	Only use cleaners and polishes that are specifically manufactured for cleaning stainless steel. Always rub in direction of metal grain to avoid damaging. Do not use cleaners with high concentrations of chlorides or chlorine. Do not use harsh scrubbing cleaners. Polish with a lint-free cloth. Always be sure to wipe excess cleaner/polish off from the metal surface as bluish stains may occur during future oven heating that cannot be removed. Clean heavier soils with hot, soapy water and a cloth or sponge. Rinse and dry using clean water and a cloth.

## General Cleaning

Refer to [Table 4](#) in this chapter for more detailed information about cleaning specific parts of the range.

**⚠ CAUTION** Before manually cleaning any part of the range, be sure all controls are turned off and the range is cool. The range may be hot and can cause burns.

**⚠ CAUTION** Ammonia must be rinsed before operating the oven. Provide adequate ventilation.

### Aluminum Foil and Utensils

**⚠ WARNING** Never cover any slots, holes, or passages in the oven bottom or cover an entire oven rack with materials such as aluminum foil. Doing so blocks air flow through the oven and may cause carbon monoxide poisoning. Aluminum foil linings may trap heat, causing a fire hazard.

**⚠ WARNING** Protective Liners — Do not use aluminum foil to line the oven bottom. Only use aluminum foil as recommended in this manual. Improper installation of these liners may result in risk of electric shock, or fire.

- Aluminum foil - Use of aluminum foil on a hot cooktop can damage the cooktop. Do not use thin aluminum cooking utensils or allow aluminum foil to touch the surface burners under any circumstances.
- Aluminum utensils - The melting point of aluminum is much lower than that of other metals. Care must be taken when aluminum pots or pans are used on the cooktop. If aluminum pans are allowed to boil dry when using the cooktop, the utensil will be damaged or destroyed.

## Cleaning the Cooktop and Surface Burners

**⚠ CAUTION** To avoid possible burns, do not attempt any of the cooktop cleaning instructions provided before turning OFF all of the surface burners and allow them to completely cool.

**⚠ CAUTION** Any additions, changes or conversions required in order for this appliance to satisfactorily meet the application needs must be made by an authorized qualified agency.

Routinely clean the cooktop. Wipe with a clean, damp cloth and wipe dry to avoid scratches.

Keeping the surface burner head ports and slots clean will prevent improper ignition and an uneven flame.

### Cleaning Recessed and Contoured Areas of Cooktop

If a spill occurs on or in the recessed or contoured areas, blot up spill with an absorbent cloth. Rinse with a clean, damp cloth and wipe dry.

### To clean surface burner grates:

- Clean only after the grates are completely cool.
- Use nonabrasive plastic scrubbing pad and mild abrasive cleanser or clean in the dishwasher.
- Food soils containing acids may affect the finish. Clean immediately after the grates are cool.
- Thoroughly dry grates immediately following cleaning.

### To clean burner caps:

- Remove caps from burner heads after they have cooled.
- Clean heavy soils with a plastic scrubbing pad and absorbent cloth.
- Thoroughly dry burner caps immediately following cleaning including the bottom and inside of cap.
- Do not use abrasive cleaners. They can scratch porcelain.
- Do not clean burner caps in the dishwasher.
- Do not operate surface burners without burner caps properly in place. Read important notes.

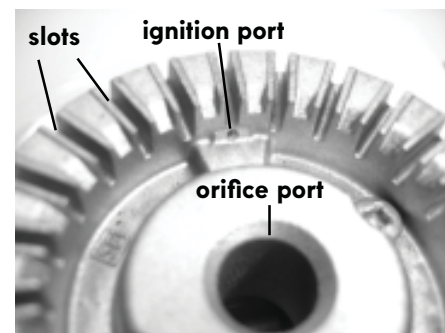

Figure 33: Cooktop burner head

### Cleaning Surface Burner Heads

For proper gas flow it may be necessary to clean the burner head and slots. To clean, first use a clean damp cloth to soak up any spills. Remove any food from between the burner slots using a small nonabrasive brush like a toothbrush and afterwards wipe up using a damp cloth. For stubborn soils located in the slots, use a small-gauge wire or needle to clean.

Any spill on or around the electrode must be carefully cleaned. Take care not to hit the electrode with any thing hard or it could be damaged.

## Care & Cleaning

### To clean the burner head ignition ports:

Each burner head has a small ignition port located as shown. Should you experience ignition problems it may be that this port hole is partially blocked with soil. With the burner head in place, use a small wire gauge needle or the end of a paper clip to clear the ignition port (Refer to [Figure 33](#); round style shown; oval burner on some models not shown).

### Important notes:

- The surface burner heads are secured to the cooktop and must be cleaned in place on the cooktop.
- Always keep the surface burner caps in place whenever a surface burner is in use.
- When replacing the burner caps, be sure the burner caps are seated firmly on top of the burner heads.
- For proper flow of gas and ignition of burners do not allow spills, food, cleaning agents or any other material to enter the gas orifice port opening.

### Replacing Oven Light (some models)

The oven light is located at the rear of the oven cavity and is covered with a glass shield held by a wire holder. The glass shield protects the light bulb and must be in place whenever the oven is in use.

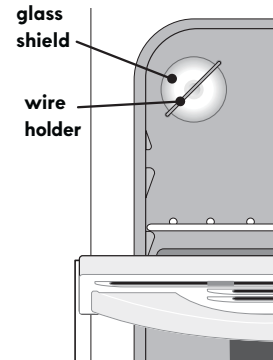

**Figure 34: Replacing the oven light**

### To replace the interior oven light bulb:

**⚠ CAUTION** Be sure the range is unplugged and all parts are cool before replacing oven light. Wear a leather-faced glove for protection against possible broken glass.

1. Turn electrical power off at the main source or unplug the range.
2. Press wire holder to one side to release the glass shield that covers the light bulb.
3. Replace light with a new 40 watt appliance bulb.
4. Replace glass shield over bulb and snap wire holder back into place.
5. Turn power on at the main source (or plug the appliance in).
6. The clock will then need to be reset. To reset, see [“Setting Clock”](#) on [page 15](#).



### Removing and Replacing the Lift-Off Oven Door

**⚠ CAUTION** To avoid possible injury when removing or replacing the oven door, follow the instructions below carefully and always hold the oven door with both hands positioned away from the door hinge area.

**⚠ CAUTION** The door is heavy. For safe, temporary storage, lay the door flat with the inside of the door facing down.

#### To remove the oven door:

1. Open oven door completely (horizontal with floor - [Figure 35](#)).
2. Pull the door hinge locks on both left and right door hinges down from the oven frame completely towards the oven door ([Figure 36](#)). A tool such as a small flat-blade screwdriver may be required.
3. Firmly grasp both sides of oven door along the door sides (Do not use the oven door handle - [Figure 37](#)).
4. Close the door to the stop position (the oven door will stop into this position just before fully closing).
5. With the oven door in the stop position, lift the oven door hinge arms over the roller pins located on each side of the oven frame ([Figure 38](#)).

#### To replace oven door:

1. Firmly grasp both sides of oven door along the door sides (Do not use the oven door handle - [Figure 37](#)).
2. Holding the oven door at the same angle as the removal position, seat the hook of the hinge arm over the roller pins located on each side of the oven door frame ([Figure 38](#)). The hook of the hinge arms must be fully seated onto the roller pins.
3. Fully open the oven door (horizontal with floor - [Figure 35](#)).
4. Push the door hinge locks up towards and into the oven frame on both left and right oven door hinges ([Figure 36](#)) to the locked position; then, close the oven door.

### Special Care Instructions

Most oven doors contain glass that can break. Follow these recommendations:

- Do not close the oven door until all the oven racks are fully in place inside the oven cavity.
- Do not hit the glass with pots, pans, or any other object.
- Scratching, hitting, jarring, or stressing the glass may weaken its structure causing an increased risk of breakage at a later time.

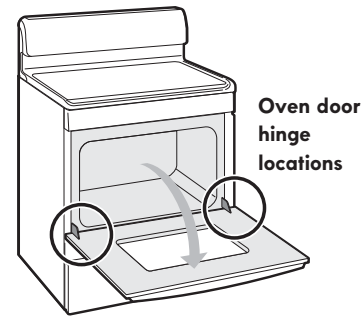

Figure 35: Oven hinge locations

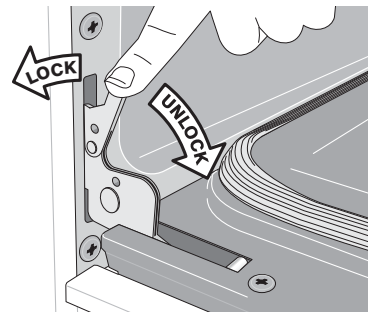

Figure 36: Hinge lock/unlock positions

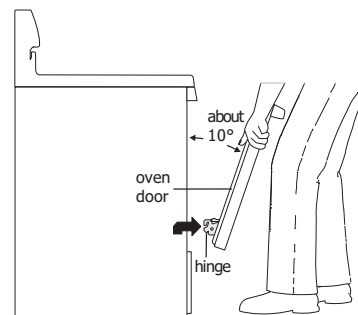

Figure 37: How to remove door

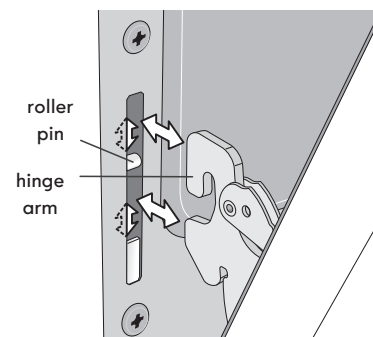

Figure 38: Hinge pin locations





# Before You Call

## Oven Baking

For best cooking results, heat the oven before baking cookies, breads, cakes, pies, pastries, et cetera. There is no need to preheat the oven for roasting meat or baking casseroles.

The cooking times and temperatures needed to bake a product may vary slightly from your previously owned appliance.

### Baking Problems and Solutions

Baking Problems	Causes	Corrections
Cookies and biscuits burn on the bottom. 	<ul style="list-style-type: none"> <li>• Cookies and biscuits put into oven before the preheating time is completed.</li> <li>• Oven rack is overcrowded.</li> <li>• Dark pans absorb heat too fast.</li> </ul>	<ul style="list-style-type: none"> <li>• Allow oven to preheat to desired temperature before placing food in oven.</li> <li>• Choose pan sizes that will permit 2" to 4" of air space (5.1 cm or 10.2 cm) on all sides when placed in the oven.</li> <li>• Use a medium weight baking sheet.</li> </ul>
Cakes too dark on top or bottom 	<ul style="list-style-type: none"> <li>• Cakes put in oven before preheating time is completed.</li> <li>• Rack position too high or too low.</li> <li>• Oven too hot.</li> </ul>	<ul style="list-style-type: none"> <li>• Allow oven to preheat to the selected temperature before placing food in the oven.</li> <li>• Use proper rack position for baking needs.</li> <li>• Set oven temperature 25°F (12°C) lower than recommended.</li> </ul>
Cakes not done in center 	<ul style="list-style-type: none"> <li>• Oven too hot.</li> <li>• Incorrect pan size.</li> <li>• Pan not centered in oven.</li> <li>• Glass cookware slow heat conductor.</li> </ul>	<ul style="list-style-type: none"> <li>• Set oven temperature 25°F (12°C) lower than recommended.</li> <li>• Use pan size suggested in recipe.</li> <li>• Use proper rack position and place pan so there is 5.1 cm to 10.2 cm (2" to 4") of space on all sides of pan.</li> <li>• Reduce temperature and increase cook time or use shiny bakeware.</li> </ul>
Cakes not level. 	<ul style="list-style-type: none"> <li>• Oven not level.</li> <li>• Pan too close to oven wall or rack overcrowded.</li> <li>• Pan warped.</li> </ul>	<ul style="list-style-type: none"> <li>• Place a marked glass measuring cup filled with water on the center of the oven rack. If the water level is uneven, refer to the installation instructions for leveling the oven.</li> <li>• Be sure to allow 5.1 cm to 10.2 cm (2" to 4") of clearance on all sides of each pan in the oven.</li> <li>• Do not use pans that are dented or warped.</li> </ul>
Foods not done when cooking time is over. 	<ul style="list-style-type: none"> <li>• Oven too cool.</li> <li>• Oven overcrowded.</li> <li>• Oven door opened too frequently.</li> </ul>	<ul style="list-style-type: none"> <li>• Set oven temperature 25°F (12°C) higher than suggested and bake for the recommended time.</li> <li>• Be sure to remove all pans from the oven except the ones to be used for baking.</li> <li>• Open oven door only after shortest recommended baking time.</li> <li>• Make sure to allow 2" to 4" of clearance between all pans and racks, allowing for even air flow.</li> </ul>

---

## Solutions to Common Problems

Before you call for service, review the following list. It may save you time and expense. Possible solutions are provided with the problem listed:

Problem	Solution
Poor baking results	<ul style="list-style-type: none"> <li>Many factors affect baking results. Make sure the proper oven rack position is used. Center food in the oven and space pans to allow air to circulate. Allow the oven to preheat to the set temperature before placing food in the oven. Try adjusting the recipe's recommended temperature or baking time. If you feel the oven is too hot or cool, see <a href="#">"Adjusting Oven Temperatures"</a> on <a href="#">page 25</a>.</li> </ul>
Appliance is not level.	<ul style="list-style-type: none"> <li>Be sure floor is level, strong, and stable enough to adequately support range.</li> <li>If floor is sagging or sloping, contact a carpenter to correct the situation.</li> <li>Poor installation. Place oven rack in center of oven. Place a level on the oven rack. Adjust leveling legs at base of appliance until the rack is level.</li> <li>Kitchen cabinet alignment may make range appear not level. Be sure cabinets are square and have sufficient room for appliance clearance.</li> </ul>
Cannot move appliance easily. Appliance must be accessible for service.	<ul style="list-style-type: none"> <li>Cabinets not square or are built in too tightly. Contact builder or installer to make appliance accessible.</li> <li>Carpet interferes with appliance. Provide sufficient space so appliance can be lifted over carpet.</li> <li>Gas line is hard-plumbed. Have a flexible CSA International approved metal appliance connector installed.</li> </ul>
Entire appliance does not operate.	<ul style="list-style-type: none"> <li>Make sure power cord is plugged properly into outlet.</li> <li>Electrical power outage. Check house lights to be sure. Call your local electric company for service outage information.</li> <li>Service wiring is not complete. Call 1-800-4-MY-HOME® for assistance (See back cover).</li> </ul>
Oven portion of appliance does not operate.	<ul style="list-style-type: none"> <li>Be sure regulator gas valve is turned to <b>ON</b>. See installation instructions.</li> <li>The time of day is not set. The time of day must first be set in order to operate the oven. See <a href="#">"Setting Clock"</a> on <a href="#">page 15</a>.</li> <li>Be sure the oven controls are set properly for the desired function. See the <a href="#">"Oven Controls"</a> chapter starting on <a href="#">page 14</a> and review instructions for the desired cooking function in this manual or see "Entire appliance does not operate" in this checklist.</li> </ul>
Oven light does not work.	<ul style="list-style-type: none"> <li>Be sure the oven light is secure in the socket. Also see <a href="#">"Replacing Oven Light (some models)"</a> on <a href="#">page 32</a>.</li> </ul>
Oven smokes excessively when broiling.	<ul style="list-style-type: none"> <li>Incorrect setting. Follow the <a href="#">"Setting Broil"</a> instructions on <a href="#">page 22</a>.</li> <li>Be sure oven door is closed when broiling.</li> <li>Meat too close to the broiler. Reposition the broil rack to provide proper clearance between the meat and the broiler. Preheat the broiler for searing.</li> <li>Meat not properly prepared. Remove excess fat from meat. Cut remaining fatty edges to prevent curling, but do not cut into lean.</li> <li>Grease has built up on oven surfaces. Regular cleaning is necessary when broiling frequently. Old grease or food spatters cause excessive smoking.</li> </ul>

---

## Before You Call

---

Flames inside oven or smoking from oven vent.	<ul style="list-style-type: none"><li>Excessive spillovers in oven. For example, this will happen for pie spillovers or large amounts of grease left on the oven bottom. Wipe up excessive spillovers before starting oven. If flames or excessive smoke are present, follow the <a href="#">“Setting Broil”</a> instructions on <a href="#">page 22</a>.</li></ul>
Oven control panel beeps and displays any F code error.	<ul style="list-style-type: none"><li>Oven control has detected a fault or error condition. Press <b>STOP</b> to clear the error code. Try Bake or Broil function. If the F code error repeats, remove power from appliance, wait 5 minutes, and then repower appliance and set clock with the correct time of day. Try Bake or Broil function again. If the fault recurs, press <b>STOP</b> to clear and call 1-800-4-MY-HOME® for assistance (See back cover).</li></ul>
Self Clean does not work.	<ul style="list-style-type: none"><li>Oven control not set properly. Review the <a href="#">“Self Clean”</a> instructions on <a href="#">page 28</a>.</li></ul>
Soil not completely removed after Self Clean.	<ul style="list-style-type: none"><li>Self Clean was interrupted. Review the <a href="#">“Self Clean”</a> instructions on <a href="#">page 28</a>.</li><li>Excessive spillovers on oven bottom. Remove before starting Self Clean.</li><li>Failure to clean soil from the oven frame, the door liner outside the oven door gasket and the small area at the front center of the oven bottom. These areas are not in the self-cleaning area, but get hot enough to burn on residue. Clean these areas before the self-cleaning cycle is started. Burned-on residue can be cleaned with a stiff nylon brush and water or a nylon scrubber. Be careful not to damage the oven gasket.</li></ul>
Oven racks discolored.	<ul style="list-style-type: none"><li>Oven racks left in oven cavity during Self Clean. Always remove oven racks from oven cavity before starting a self-clean cycle. Clean by using a mild, abrasive cleaner following manufacturer's instructions. Rinse with clean water, dry and replace in oven.</li></ul>
Convection fan does not rotate.	<ul style="list-style-type: none"><li>Allow 6 minutes for convection fan to start rotating after setting Convection.</li><li>Oven door is open. Convection fan will turn off if oven door is opened when Convection is active. Close oven door.</li></ul>
Surface burners do not ignite.	<ul style="list-style-type: none"><li>Surface control knob was not completely turned to LITE. Push in and turn the surface control knob to LITE until burner ignites and then turn control knob to desired flame size.</li><li>Burner ports are clogged. With the burner OFF, use a small-gauge wire or needle to burner head slots and ignition ports. See <a href="#">“Cleaning the Cooktop and Surface Burners”</a> in the Care &amp; Cleaning section on <a href="#">page 31</a> for additional cleaning instructions.</li><li>Range power cord is disconnected from outlet (electric ignition models only). Be sure power cord is securely plugged into the power outlet.</li><li>Electrical power outage. Burners may be lit manually. See <a href="#">“Setting Surface Burners”</a> on <a href="#">page 13</a>.</li></ul>
Surface burner flame uneven or only part way around burner cap.	<ul style="list-style-type: none"><li>Burner slots or ports are clogged. With the surface burner OFF, clean ports with a small-gauge wire or needle.</li><li>Moisture is present after cleaning. Lightly fan the flame and allow burner to operate until flame is full.</li><li>Burner caps are not seated properly. Check that all burner caps are level and seated correctly on burner heads. See <a href="#">“Cleaning the Cooktop and Surface Burners”</a> in the Care &amp; Cleaning section on <a href="#">page 31</a> for additional cleaning instructions.</li></ul>
Surface burner flame is too high.	<ul style="list-style-type: none"><li>Surface control knob is set too high. Adjust to lower flame setting.</li><li>Burner caps are not seated properly. Check that all surface burner caps are level and seated correctly on surface burner heads. See <a href="#">“Cleaning the Cooktop and Surface Burners”</a> in the Care &amp; Cleaning section on <a href="#">page 31</a> for additional cleaning instructions.</li><li>Incorrect L.P. conversion. Refer to L.P. conversion kit instructions to correct.</li></ul>

---

---

Surface burner flame is orange.

- Dust particles in main gas line. Allow the burner to operate a few minutes until flame turns blue. In coastal areas, a slightly orange flame is unavoidable due to salt content in air.
  - Incorrect L.P. conversion. Refer to L.P. conversion kit instructions to correct.
-

## Before You Call

### Master Protection Agreements

*Congratulations on making a smart purchase.* Your new Kenmore® product is designed and manufactured for years of dependable operation. But like all products, it may require preventive maintenance or repair from time to time. That's when having a Master Protection Agreement can save you money and aggravation.

The Master Protection Agreement also helps extend the life of your new product. Here's what the Agreement\* includes:

- ☑ **Parts and labor** needed to help keep products operating properly **under normal use**, not just defects. Our coverage goes **well beyond the product warranty**. No deductibles, no functional failure excluded from coverage – **real protection**.
- ☑ **Expert service** by a force of more than **10,000 authorized Sears service technicians**, which means someone you can trust will be working on your product.
- ☑ **Unlimited service calls and nationwide service**, as often as you want us, whenever you want us.
- ☑ **"No-lemon" guarantee** – replacement of your covered product if four or more product failures occur within twelve months.
- ☑ **Product replacement** if your covered product can't be fixed.
- ☑ **Annual Preventive Maintenance Check** at your request – no extra charge.
- ☑ **Fast help by phone** – we call it **Rapid Resolution** – phone support from a Sears representative on all products. Think of us as a "talking owner's manual".
- ☑ **Power surge protection** against electrical damage due to power fluctuations.
- ☑ **\$250 Food Loss Protection** annually for any food spoilage that is the result of mechanical failure of any covered refrigerator or freezer.
- ☑ **Rental reimbursement** if repair of your covered product takes longer than promised.
- ☑ **25% discount** off the regular price of any non-covered repair service and related installed parts.

Once you purchase the Agreement, a simple phone call is all that it takes for you to schedule service. You can call anytime day or night, or schedule a service appointment online.

The Master Protection Agreement is a risk free purchase. If you cancel for any reason during the product warranty period, we will provide a full refund. Or, a prorated refund anytime after the product warranty period expires. Purchase your Master Protection Agreement today!

**Some limitations and exclusions apply. For prices and additional information in the U.S.A. call 1-800-827-6655.**

**\* Coverage in Canada varies on some items. For full details call Sears Canada at 1-800-361-6665.**

### Sears Installation Service

*For Sears professional installation* of home appliances, garage door openers, water heaters, and other major home items, in the U.S.A. or Canada call **1-800-4-MY-HOME®**.

### Acuerdos maestros de protección

*Enhorabuena por haber hecho una compra inteligente.* Su nuevo producto Kenmore® está diseñado y fabricado para brindarle años de funcionamiento fiable. Pero, como cualquier producto, puede necesitar mantenimiento preventivo o reparaciones periódicas. Es por eso que tener un Acuerdo maestro de protección podría ahorrarle dinero y molestias.

El Acuerdo maestro de protección también sirve para prolongar la durabilidad de su nuevo producto. El acuerdo\* incluye lo siguiente:

- ☑ **Piezas y mano de obra** necesarias para contribuir a mantener el funcionamiento adecuado de los productos **utilizados en condiciones normales de uso**, no sólo en caso de defectos de los productos. Nuestra cobertura va **mucho más allá que la garantía del producto**. No se aplican deducibles ni exclusiones por fallas del funcionamiento: es decir, **verdadera protección**.
- ☑ **Servicio técnico por expertos** (más de **10000 técnicos autorizados de Sears**), lo cual significa que quien repare o realice el mantenimiento de su producto será un profesional de confianza.
- ☑ **Servicio técnico a escala nacional y número ilimitado de llamadas de solicitud de servicio técnico**: se puede poner en contacto con nosotros cuantas veces lo desee y cuando lo desee.
- ☑ **Garantía "sin sorpresas"**: se reemplaza el producto cubierto por el acuerdo si ocurren cuatro o más fallas del producto en un periodo de 12 meses.
- ☑ **Reemplazo del producto**: en caso de que no se pueda reparar el producto cubierto por el acuerdo.
- ☑ **Revisión anual preventiva de mantenimiento del producto**: puede solicitarla en cualquier momento, sin costo alguno.
- ☑ **Rápida asistencia telefónica**, la cual denominamos **Solución rápida**: es decir, asistencia telefónica a través de cualquiera de nuestros representantes de Sears, sobre cualquiera de nuestros productos. Piense en nosotros como en un "manual parlante del usuario".
- ☑ **Protección contra fallas eléctricas**, contra daños debidos a fluctuaciones de la corriente eléctrica.
- ☑ **\$250 al año para cubrir cualquier posible deterioro de alimentos** que haya tenido que desechar debido a una falla mecánica de cualquiera de nuestros refrigeradores o congeladores cubiertos por este acuerdo.
- ☑ **Devolución de gastos de alquiler de electrodomésticos** si la reparación de su producto asegurado toma más que el tiempo prometido.
- ☑ **25% de descuento** aplicable tanto a los costos del servicio de reparación, como de las piezas instaladas relacionadas que no hayan quedado cubiertos por este acuerdo.

Una vez que haya realizado el pago de este acuerdo, bastará una simple llamada telefónica para concertar una visita de servicio. Puede llamar a cualquier hora del día o de la noche, o bien concertar una visita de servicio por Internet.

La adquisición del Acuerdo maestro de protección es una inversión exenta de riesgos. Si por cualquier motivo decide cancelar dicho acuerdo durante el periodo de garantía del producto, le haremos un reintegro total del valor. O bien un importe proporcional si cancela el acuerdo en cualquier otro momento posterior al vencimiento del periodo de garantía del producto. ¡Adquiera hoy mismo su Acuerdo maestro de protección!

**Algunas limitaciones y exclusiones podrían aplicarse. Para solicitar precios e información adicional, llame al 1-800-827-6655 (en los EE.UU.).**

**\* La cobertura en Canadá varía en el caso de algunos artículos. Para obtener detalles completos al respecto, llame al 1-800-361-6665 de Sears de Canadá.**

### Servicio de instalación de Sears

*Para solicitar la instalación por profesionales de Sears* de electrodomésticos, abridores de puertas de garaje, calentadores de agua y otros artículos de uso prioritario en el hogar, **llame al 1-800-4-MY-HOME** en los EE.UU. o Canadá.

# Get it fixed, at your home or ours!

## Your Home

For troubleshooting, product manuals and expert advice:



[www.managemylife.com](http://www.managemylife.com)

For repair – **in your home** – of **all** major brand appliances, lawn and garden equipment, or heating and cooling systems, **no matter who made it, no matter who sold it!**

For the replacement parts, accessories and owner's manuals that you need to do-it-yourself.

For Sears professional installation of home appliances and items like garage door openers and water heaters.

**1-800-4-MY-HOME<sup>®</sup>** (1-800-469-4663)

Call anytime, day or night (U.S.A. and Canada)

[www.sears.com](http://www.sears.com)      [www.sears.ca](http://www.sears.ca)

## Our Home

For repair of carry-in items like vacuums, lawn equipment, and electronics, call anytime for the location of your nearest

**Sears Parts & Repair Service Center**

**1-800-488-1222** (U.S.A.)      **1-800-469-4663** (Canada)

[www.sears.com](http://www.sears.com)      [www.sears.ca](http://www.sears.ca)

To purchase a protection agreement on a product serviced by Sears:

**1-800-827-6655** (U.S.A.)      **1-800-361-6665** (Canada)

Para pedir servicio de reparación a domicilio, y para ordenar piezas:

**1-888-SU-HOGAR<sup>®</sup>**

(1-888-784-6427)

[www.sears.com](http://www.sears.com)

Au Canada pour service en français:

**1-800-LE-FOYER<sup>MC</sup>**

(1-800-533-6937)

[www.sears.ca](http://www.sears.ca)

The Sears logo, consisting of the word "sears" in a lowercase, serif font.

® Registered Trademark / <sup>TM</sup> Trademark of KCD IP, LLC in the United States, or Sears Brands, LLC in other countries

© Marca Registrada / <sup>TM</sup> Marca de Fábrica de KCD IP, LLC en Estados Unidos, o Sears Brands, LLC in otros países

<sup>MC</sup> Marque de commerce / <sup>MD</sup> Marque déposée de Sears Brands, LLC

## Free Manuals Download Website

<http://myh66.com>

<http://usermanuals.us>

<http://www.somanuals.com>

<http://www.4manuals.cc>

<http://www.manual-lib.com>

<http://www.404manual.com>

<http://www.luxmanual.com>

<http://aubethermostatmanual.com>

Golf course search by state

<http://golfingnear.com>

Email search by domain

<http://emailbydomain.com>

Auto manuals search

<http://auto.somanuals.com>

TV manuals search

<http://tv.somanuals.com>