

Use & Care Guide
Guía de uso y cuidada
English / Español

Model/Modelos: 790. 9021*

Kenmore®

Electric Range

Estufa eléctrica

* = color number, código de color

P/N 316902006 Rev A

Sears Brands Management Corporation
Hoffman Estates, IL 60179 U.S.A.

www.kenmore.com
www.sears.com



Table of Contents

Appliance Warranty	2	Setting Timer	12
Important Safety Instructions	3-6	Oven Lockout	13
Product Record/Serial Plate Location	6	Setting Bake	13
Before Setting Oven Controls	7	Broil	14
Removing, replacing and arranging oven racks	7	Adjusting Oven Temperature	15
Before Setting Surface Controls	8-9	Select Clean	16-17
Using proper cookware	8	Care & Cleaning	18-22
Cookware material types	9	Cleaning recommendation table	18
Home canning	9	General cleaning	19
Setting Surface Controls	10	Surface elements and drip bowls	20
Surface element settings	10	Replacing oven light	21
Oven Control Features	11	Removing and replacing lift-off oven door	22
Setting Oven Controls	11-15	Before You Call - Solutions to common problems	23-25
Setting Clock	11	Master Protection Agreement	27
Changing oven temperature display (F° or C°)	12	Sears Service	back cover

Kenmore Limited Warranty

When installed, operated and maintained according to all instructions supplied with the product, if this appliance fails due to a defect in material and workmanship within one year from the date of purchase, call 1-800-4-MY-HOME® to arrange for free repair. This warranty applies for only 90 days from the date of purchase if this appliance is ever used for other than private family purposes.

This warranty covers only defects in material and workmanship. Sears will NOT pay for:

1. Cracks in a ceramic glass cooktop that are not a result of thermal shock.
2. Stains and scratches on a ceramic glass cooktop resulting from failure to maintain it properly according to all instructions supplied with the product.
3. Expendable items that can wear out from normal use, including but not limited to filters, belts, light bulbs, and bags.
4. A service technician to instruct the user in correct product installation, operation or maintenance.
5. A service technician to clean or maintain this product.
6. Damage to or failure of this product if it is not installed, operated or maintained according to all instructions supplied with the product.
7. Damage to or failure of this product resulting from accident, abuse, misuse or use for other than its intended purpose.
8. Damage to or failure of this product caused by the use of detergents, cleaners, chemicals or utensils other than those recommended in all instructions supplied with the product.
9. Damage to or failure of parts or systems resulting from unauthorized modifications made to this product.

Disclaimer of implied warranties; limitation of remedies

Customer's sole and exclusive remedy under this limited warranty shall be product repair as provided herein. Implied warranties, including warranties of merchantability or fitness for a particular purpose, are limited to one year or the shortest period allowed by law. Sears shall not be liable for incidental or consequential damages. Some states and provinces do not allow the exclusion or limitation of incidental or consequential damages, or limitation on the duration of implied warranties of merchantability or fitness, so these exclusions or limitations may not apply to you.

This warranty applies only while this appliance is used in the United States or Canada.

This warranty gives you specific legal rights, and you may also have other rights which vary from state to state.

Sears Brands Management Corporation, Hoffman Estates, IL 60179 U.S.A.

Sears Canada Inc., Toronto, Ontario, Canada M5B 2B8

Important Safety Instructions

Read all instructions before using this appliance.

This manual contains important safety symbols and instructions. Please pay attention to these symbols and follow all instructions given.

Definitions

⚠ This is the safety alert symbol. It is used to alert you to potential personal injury hazards. Obey all safety messages that follow this symbol to avoid possible injury or death.

Do not attempt to install or operate your appliance until you have read the safety precautions in this manual. Safety items throughout this manual are labeled with a WARNING or CAUTION statement based on the risk type.

⚠ WARNING - indicates a potentially hazardous situation which, if not avoided, may result in death or serious injury.

⚠ CAUTION - indicates a potentially hazardous situation which, if not avoided, may result in minor or moderate injury.

- **Remove all tape and packaging before using the range.**
Destroy the carton and plastic bags after unpacking the range. Never allow children to play with packaging material.
- **Proper installation—Be sure your appliance is properly installed and grounded by a qualified technician in accordance with the National Electrical Code ANSI/NFPA No. 70 latest edition and local electrical code requirements.** Install only per installation instructions provided in the literature package for this range.
- **User servicing—Do not repair or replace any part of the appliance unless specifically recommended in the manuals.** All other servicing should be done only by a qualified technician. This may reduce the risk of personal injury and damage to the range.

Ask your dealer to recommend a qualified technician and an authorized repair service. Know how to disconnect the power to the range at the circuit breaker or fuse box in case of an emergency.

⚠ WARNING

- All ranges can tip.
- Injury to persons could result.
- Install anti-tip device packed with range.
- See Installation Instructions.



To reduce the risk of tipping, the range must be secured by properly installed anti-tip bracket provided with the range. To check if the bracket is installed properly, visually check that rear leveling leg is inserted into and fully secured by the anti-tip bracket by removing lower front panel or storage drawer from the range.



For models equipped with a warmer drawer or lower oven, grasp the top rear edge of the range and carefully attempt to tilt it forward. Refer to the installation instructions for proper anti-tip bracket installation.

- **Never modify or alter the construction of a range by removing the leveling legs, panels, wire covers, anti-tip brackets/screws, or any other part of the range.**
- Remove the oven door from any unused range if it is to be stored or discarded.
- **Do not attempt to operate the range during a power failure.** If the power fails, always turn off the range. If the range is not turned off and the power resumes, the range will begin to operate again. Once the power resumes, reset the clock and oven function.

⚠ WARNING Stepping, leaning or sitting on the door or drawers of a range can result in serious injuries and also cause damage to the appliance. **DO NOT** allow children to climb or play around the range. The weight of a child on an open oven door may cause the range to tip, resulting in serious burns or other injury.

⚠ WARNING Storage in or on appliance — flammable materials should not be stored in an oven, near surface units or in the storage drawer, warmer drawer or lower oven. This includes paper, plastic and cloth items, such as cookbooks, plasticware and towels, as well as flammable liquids. Do not store explosives, such as aerosol cans, on or near the range.

Save these instructions for future reference.

Important Safety Instructions

⚠ WARNING NEVER cover any slots, holes or passages in the oven bottom or cover an entire oven rack with materials such as aluminum foil. Aluminum foil linings may trap heat, causing a fire hazard.

⚠ WARNING DO NOT LEAVE CHILDREN ALONE — children should not be left alone or unattended in the area where appliance is in use. They should never be allowed to sit or stand on any part of the appliance, including the storage drawer, lower broiler drawer, warmer drawer or lower double oven.

⚠ CAUTION Do not store items of interest to children in the cabinets above a range or on the backguard of the range. Children climbing on the range to reach items could be seriously injured.

⚠ CAUTION DO NOT TOUCH SURFACE HEATING UNITS, OR SURFACE COOKING ELEMENTS, AREAS NEAR THESE SURFACE HEATING UNITS, OR INTERIOR SURFACE OF THE OVEN. Both surface heating and oven heating elements may be hot even though they are dark in color. Areas near surface cooking units may become hot enough to cause burns. During and after use, do not touch, or let clothing or other flammable materials touch these areas until they have had sufficient time to cool. Among these areas are the cook top, surfaces facing the cook top, the oven vent openings and surfaces near these openings, oven door and oven door window.

⚠ CAUTION Wear proper apparel — loose-fitting or hanging garments should never be worn while using the appliance. Do not let clothing or other flammable materials contact hot surfaces.

⚠ CAUTION DO NOT USE WATER OR FLOUR on grease fires — smother the fire with a pan lid, or use baking soda, a dry chemical or foam-type extinguisher.

⚠ CAUTION When heating fat or grease, watch it closely. Fat or grease may catch fire if allowed to become too hot.

⚠ CAUTION Use dry potholders — moist or damp potholders on hot surfaces may result in burns from steam. Do not let potholders touch hot heating elements. Do not use a towel or other bulky cloth instead of a potholder.

⚠ CAUTION Do not heat unopened food containers — buildup of pressure may cause container to burst and result in injury.

Important Safety Notice

The California Safe Drinking Water and Toxic Enforcement Act requires the Governor of California to publish a list of substances known to the state to cause cancer, birth defects or other reproductive harm, and requires businesses to warn customers of potential exposure to such substances.

IMPORTANT INSTRUCTIONS FOR USING YOUR OVEN

⚠ WARNING Protective Liners — DO NOT USE ALUMINUM FOIL to line the oven bottom. Only use aluminum foil as recommended in this manual. Improper installation of these liners may result in risk of electric shock, or fire.

- **Use care when opening oven door, warmer drawer or lower oven door** — Stand to the side of the range when opening the door of a hot oven. Let hot air or steam escape before you remove or replace food in the oven.
- **Keep oven vent ducts unobstructed.** The oven vent is located below the backguard. Touching the surfaces in this area when the oven is operating may cause severe burns. Also, do not place plastic or heat-sensitive items on or near the oven vent. These items could melt or ignite.
- **Placement of interior oven racks.** Always place oven racks in desired location while oven is cool. If rack must be moved while oven is hot use extreme caution. Use potholders and grasp the rack with both hands to reposition. Do not let potholders contact the hot heating elements in the oven. Remove all utensils from the rack before moving.
- **Do not use the broiler pan without its insert.** The broiler pan and its insert allow dripping fat to drain and be kept away from the high heat of the broiler.
- **Do not cover the broiler insert with aluminum foil.** Exposed fat and grease could ignite.

Save these instructions for future reference.

Important Safety Instructions

IMPORTANT INSTRUCTIONS FOR USING YOUR COOKTOP

- Know which knob controls each surface heating unit.
Place a pan of food on the surface element unit before turning it on, and turn the element off before removing the pan.
- Use proper pan size — This appliance is equipped with one or more surface units of different sizes. Select utensils having flat bottoms large enough to cover the surface unit heating element. The use of undersized utensils will expose a portion of the heating element to direct contact and may result in ignition of clothing. Proper relationship of utensil to element will also improve efficiency.
- Utensil handles should be turned inward and not extend over adjacent surface elements — To reduce the risk of burns, ignition of flammable materials, and spillage due to unintentional contact with the utensil, the handle of the utensil should be positioned so that it is turned inward, and does not extend over adjacent surface units.
- Never leave surface elements unattended at high heat settings — Boilovers cause smoking and greasy spillovers that may ignite, or a pan that has boiled dry may melt.
- Glazed cooking utensils — Only certain types of glass, glass/ceramic, ceramic, earthenware, or other glazed utensils are suitable for cook top service without breaking due to the sudden change in temperature. Check the manufacturer's recommendations for cook top use.
- When flaming foods under a ventilating hood, turn the fan on.

COIL COOK TOP MODELS

⚠ CAUTION Protective liners — Do not use aluminum foil to line surface unit drip bowls, or reflector pans. Only use aluminum foil as recommended in this manual. Improper installation of these liners may result in risk of electric shock, or fire.

- Make sure reflector pans or drip bowls are in place — Absence of these pans or bowls during cooking may subject wiring or components underneath to damage.

Save these instructions for future reference.

Important Safety Instructions

IMPORTANT INSTRUCTIONS FOR CLEANING YOUR RANGE

⚠ CAUTION Before manually cleaning any part of the range, be sure all controls are turned OFF and the range is COOL. **The range may be hot** and can cause burns.

- **Clean the range regularly to keep all parts free of grease that could catch fire.** Pay particular attention to the area around each surface element. Do not allow grease to accumulate.
- **Kitchen cleaners and aerosols — Always follow the manufacturer's recommended directions for use.** Be aware that excess residue from cleaners and aerosols may ignite causing damage and injury.
- **Clean ventilating hoods frequently — Grease should not be allowed to accumulate on the hood or filter.** Follow the manufacturer's instructions for cleaning hoods.

Product Record

In this space below, record the date of purchase, model and serial number of your product. You will find the model and serial number printed on an identification plate. **See bottom of this page** for serial plate location.

Model No. 790.

Serial No. _____

Date of Purchase _____

Save sales receipt for future reference.

Serial Plate Location

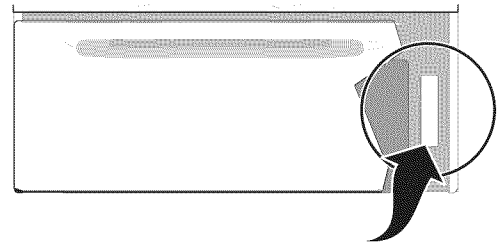

To locate the serial plate open the storage drawer. The serial plate is attached to the lower right oven frame.

Save these instructions for future reference.

Before Setting Oven Controls

Oven vent location

The oven vent is located **under the left rear surface element** (See Fig. 1). When the oven is on, warm air passes through this vent. This venting is necessary for proper air circulation in the oven and good baking results. Do not block oven vent.

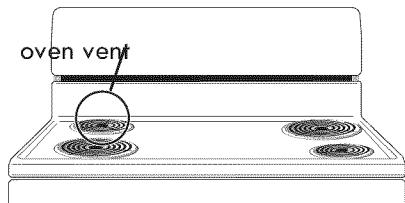

Fig. 1

Removing, replacing and arranging racks

CAUTION Always use pot holders or oven mitts when using the oven. When cooking, the oven interior and exterior, oven racks and cooktop will become very hot which can cause burns.

WARNING Protective Liners — **DO NOT USE ALUMINUM FOIL** to line the oven bottom. Only use aluminum foil as recommended in this manual. Improper installation of these liners may result in risk of electric shock, or fire.

Arranging - always arrange the oven racks when the oven is cool (prior to operating the oven).

To remove - pull the rack forward until it stops. Lift up front of rack and slide out.

To replace - fit oven rack onto the rack guides on both sides of oven walls. Tilt the front of oven rack upward and slide the rack back into place. Be sure oven racks are level before using.

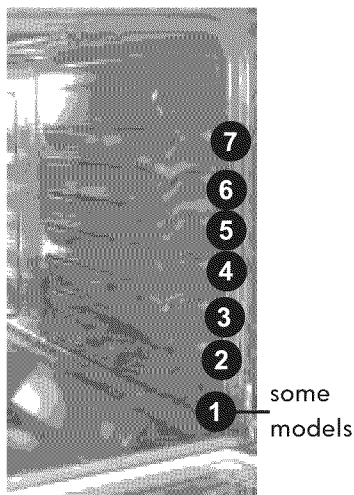
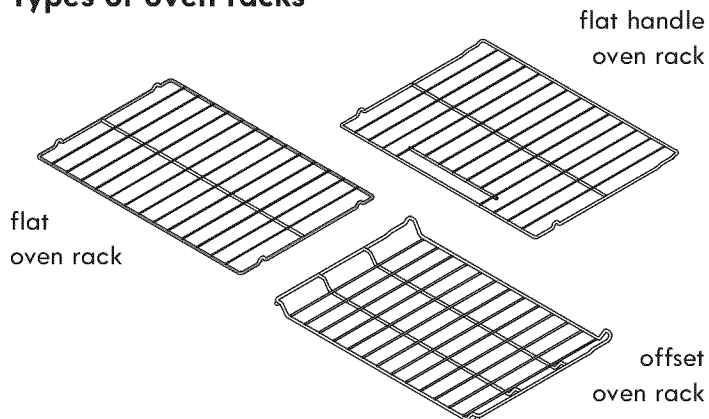

Fig. 2

Recommended oven rack positions by food type:

Food type	Position
Broiling	See broil
Cookies, cakes, pies, biscuits & muffins	4 or 5
Frozen pies, angel food cake, yeast, bread and casseroles	2 or 3
Small cuts of meat or poultry	1 or 2
Turkey, roast or ham	1 or 2

Types of oven racks



The flat oven rack or flat handle oven rack (on some models) may be used for most cooking needs.

The offset oven rack (on some models) will place the base of the rack about 1/2 of a rack position lower than a flat oven rack. This feature provides several additional possible oven rack positions.

Air circulation in the oven

For best baking results allow 2-4" (5-10 cm) around the cookware for proper air circulation and be sure pans and cookware do not touch each other, the oven door, sides or back of the oven cavity. Hot air must be able to circulate around the pans and cookware in the oven for even heat to reach around the food.

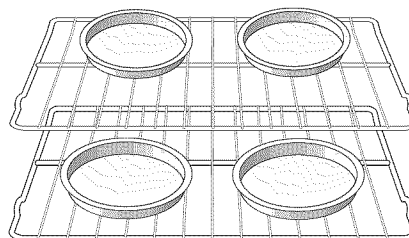

Baking layer cakes with 1 or 2 oven racks

For best results when baking cakes or cookies using 2 oven racks, place cookware on rack positions 2 and 5 (6 using the offset oven rack on some models). For best results when baking cakes or cookies using a single oven rack, place cookware on rack in positions 2, 3 or 4 (See Fig. 2).

Before Setting Surface Controls

About the surface elements

The element temperature rises gradually and evenly. As the temperature rises, the element will glow red.

For efficient cooking, turn OFF the surface element just before cooking is complete. This will allow residual heat to complete the cooking process.

CAUTION Surface elements may appear to have cooled after they have been turned off. **The surface element may still be hot** and burns may occur if the surface element is touched before it has cooled sufficiently.

CAUTION Do not place plastic items such as salt and pepper shakers, spoon holders or plastic wrappings on top of the range when it is in use. These items could melt or ignite. Potholders, towels or wooden spoons could catch fire if placed too close to the surface elements.

CAUTION Do not use aluminum foil to line surface unit drip bowls, or reflector pans. Only use aluminum foil as recommended in this manual. Improper installation of these liners may result in risk of electric shock, or fire.

Do not place aluminum foil or ANY material that could melt on the surface elements.

Make sure reflector pans or drip bowls are in place — Absence of these pans or bowls during cooking may subject wiring or components underneath to damage.

Element On indicator lights

The **ELEMENT ON** indicator lights are marked on the control panel and will glow when a surface cooking element is turned ON. A quick glance at these indicator lights after cooking is an easy check to be sure ALL surface controls are turned OFF.

ELEMENT ON



Using proper cookware

The size and type of cookware used will influence the surface element power level setting needed for best cooking results. Be sure to follow the recommendations for using proper cookware as illustrated in both Figs. 1 & 2.

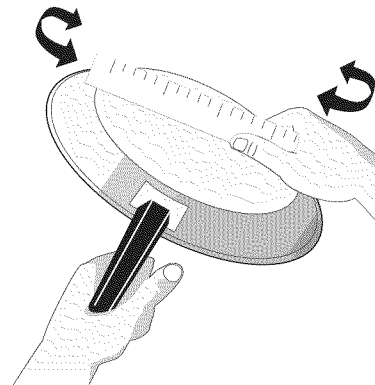
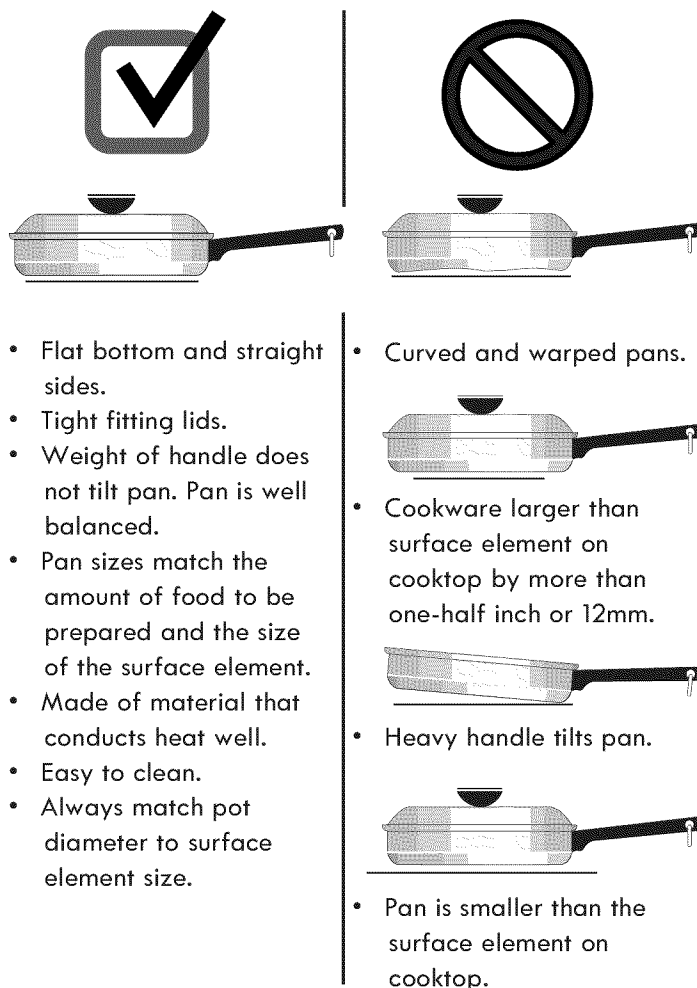

Fig. 1

Check for flatness by rotating a ruler across the bottom of the cookware (See Fig. 1). Cookware should have flat bottoms that make good contact with the entire surface heating element (See Fig. 2).



- Flat bottom and straight sides.
- Tight fitting lids.
- Weight of handle does not tilt pan. Pan is well balanced.
- Pan sizes match the amount of food to be prepared and the size of the surface element.
- Made of material that conducts heat well.
- Easy to clean.
- Always match pot diameter to surface element size.
- Curved and warped pans.
- Cookware larger than surface element on cooktop by more than one-half inch or 12mm.
- Heavy handle tilts pan.
- Pan is smaller than the surface element on cooktop.

Fig. 2

Before Setting Surface Controls

Cookware material types

The cookware material determines how evenly and quickly heat is transferred from the surface element to the pan bottom. The most popular materials available are:

Aluminum - Excellent heat conductor. Some types of food will cause it to darken (Anodized aluminum cookware resists staining & pitting).

Copper - Excellent heat conductor but discolors easily.

Stainless - Slow heat conductor with uneven cooking results. Is durable, easy to clean and resists staining.

Cast Iron - A slow heat conductor however will retain heat very well. Cooks evenly once cooking temperature is reached.

Porcelain-enamel on metal - Heating characteristics will vary depending on base material.

Glass - Slow heat conductor.

Home Canning

Be sure to read and observe all the following points when home canning with your appliance. Check with the USDA (United States Department of Agriculture) website and be sure to read all the information they have available as well as follow their recommendations for home canning procedures.

- Use only quality flat bottom canners when home canning. Use a straight-edge to check canner bottom.
- Use only a completely flat bottom canner with no ridges that radiate from the bottom center when home canning using a ceramic cooktop.
- Make sure the diameter of the canner does not exceed 1 inch beyond the surface element markings or burner. It is recommended to use smaller diameter canners on electric coil and ceramic glass cooktops.
- Start with hot tap water to bring water to boil more quickly.
- Use the highest heat setting when first bringing the water to a boil. Once boiling is achieved, reduce heat to lowest possible setting to maintain that boil.
- NEVER place or straddle a cooking utensil over 2 different surface cooking areas at the same time. This will cause uneven heating results and may cause the ceramic cooktop to fracture.

Setting Surface Controls

Surface element settings

The size and type of utensil used, and the amount and type of food being cooked will influence the surface element power level setting needed for best cooking results.

The suggested settings found in Fig. 1 below are based when cooking with medium-weight aluminum pans with lids. Settings may vary when using other types of pans.

Suggested settings for surface elements

Settings	Type of cooking
High (HI - 9)	Start most foods, bring water to a boil, pan broiling
Medium high (7 - 8)	Continue a rapid boil, fry, deep fat fry
Medium (5 - 6)	Maintain a slow boil, thicken sauces and gravies or steam vegetables
Medium Low (2 - 4)	Keep foods cooking, poach, stew
Low (LO - 1)	Keep warm, melt, simmer

Fig. 1

⚠ CAUTION Surface elements may appear to have cooled after they have been turned off. **The surface element may still be hot** and burns may occur if the surface element is touched before it has cooled sufficiently.

⚠ CAUTION Do not place plastic items such as salt and pepper shakers, spoon holders or plastic wrappings on top of the range when it is in use. These items could melt or ignite. Potholders, towels or wooden spoons could catch fire if placed too close to the surface elements.

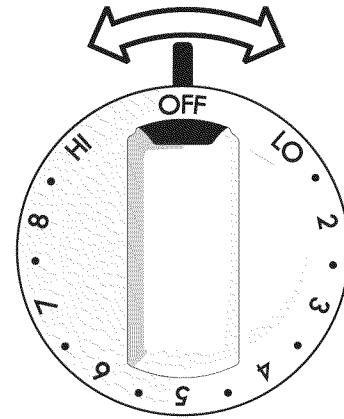

Fig. 2

To operate the single radiant element:

1. Place correctly sized cookware on surface element.
2. Push in and turn the surface control knob in either direction to the desired setting (See Fig. 2).
3. When cooking is complete, turn the surface element OFF before removing the cookware.

Important notes:

- The surface control knobs do not have to be set exactly on a particular spot. Use the graphics provided as a guide and adjust the control knob as needed. Refer to Fig. 1 for suggested power level settings.
- Start most cooking operations on a higher setting and then turn to a lower setting to finish cooking.
- The ELEMENT ON indicator light(s) will glow when one or more surface elements are turned ON. A quick glance at this indicator light when finished surface cooking is an easy check to be sure all surface controls are turned OFF.

Oven Control Functions

For satisfactory use of your oven, become familiar with the various key pad functions and features of the oven.

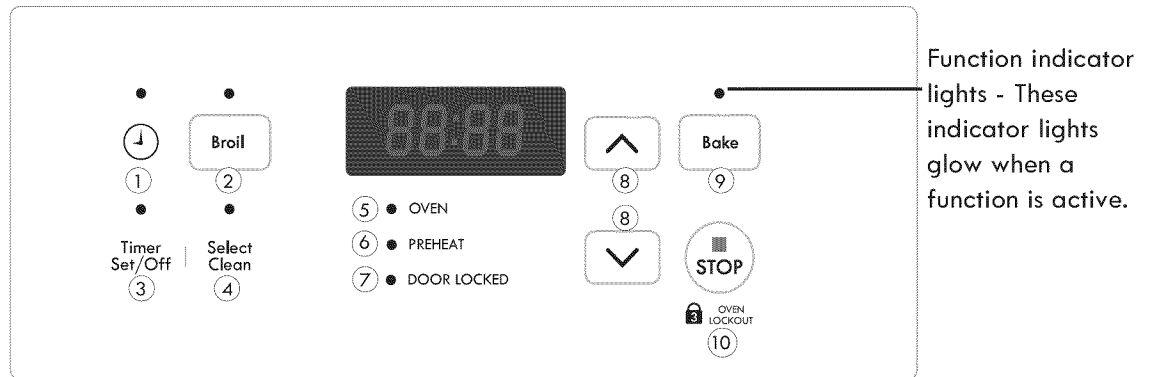

Oven control keypads



1. **Clock** - Use to set the time of day.
2. **Broil** - Use to select variable broil function.
3. **Timer Set/Off** - Use to set or cancel the timer. Timer Set/Off is used to set the continuous bake feature.
4. **Select Clean** - Use to select a 2, 3 or 4 hour Self-Clean cycle time.
5. **OVEN indicator light** - The OVEN light will glow each time the oven turns on to maintain the set oven temperature.
6. **PREHEAT indicator light** - The PREHEAT light will glow when the oven is first set for cooking and remain on until the oven reaches the set temperature.
7. **DOOR LOCKED indicator light** - The DOOR LOCKED light will glow when the oven door locks or unlocks, oven lockout is active or when Select Clean is active.
8. **Up / Down arrow key pads** - Use with the function key pads to accept settings and to adjust temperature and times.
9. **Bake** - Use to select Bake function.
10. **STOP** - Use to cancel any active oven function except clock or timer. Use to activate or cancel **OVEN LOCKOUT**.

Setting Oven Controls

Setting Clock

When the appliance is first powered up or when the power supply to the appliance has been interrupted, 12:00 will flash in the display (See Fig. 1). The time of day must first be set before operating the oven.

To set the clock:

1. Press  key pad once (do not hold key pad down).
2. Within 5 seconds, press and continue pressing the  or  key pad until the correct time of day appears in the display. Release key pad.

Important note:

The time of day cannot be changed when the oven is set for cooking or when Select Clean is active.

Operating oven light (on some models)

The interior oven light will automatically turn ON when the oven door is opened.

Press the interior oven light rocker switch located on the top left-hand control panel to turn the interior oven light ON and OFF whenever the oven door is closed.

The interior oven light is located at the upper left rear wall of the oven interior and is covered with a glass shield held by a wire holder. The glass shield protects the bulb from high temperatures and should always be in place whenever the oven is in use.



To change the interior oven light, see **Changing oven light** in the Care & Cleaning section.

Setting Oven Controls

Changing temperature display (°F or °C)

The electronic oven control is set to display °F (Fahrenheit) when shipped from the factory. The display may be changed to show either Fahrenheit or Celsius oven temperatures.

To change temperature display mode from °F to °C (Celsius) or from °C to °F (Fahrenheit):

1. Press **Broil** key pad. — — appears in the display.
2. Press and hold  until **HI** appears in display.
3. Press and hold **Broil** key pad until **F** or **C** appears in the display.
4. Press either  or  key pad to toggle between **F** (Fahrenheit) or **C** (Celsius) mode choices. Release key pad when desired mode is displayed.
5. To accept selection, press any control key pad once. The display will return to the time of day.

Important note:

The temperature display mode cannot be changed when the oven is set for cooking or Select Clean is active.

Changing between continuous bake setting or 12-Hour Energy Saving feature

The oven control has a factory preset 12-Hour Energy Saving feature that will turn the oven off automatically if the oven is left on for more than 12 hours. The control may be programmed to override this feature to continuously bake.

To change to continuous bake mode:

Press and hold **Timer Set/Off** key pad until the control beeps once (about 6 seconds). - - hr will appear in display indicating the control is now set for continuous bake setting.

To change to 12-Hour Energy Saving feature:

Press and hold **Timer Set/Off** key pad until the control beeps once (about 6 seconds). 12hr will now appear in display indicating the control is set for 12-Hour Energy Saving feature.



Important note:

Changing between continuous bake or the 12-Hour Energy saving mode does not change how the cooktop controls operate.



Setting Timer

The timer allows you to track your cooking times without interfering the cooking process. The timer may be set from 1 minute up to 11 hours and 59 minutes.

To set the timer:

1. Press **Timer Set/Off** key pad.
2. Press the  to increase the time in one minute increments. Press and hold  to increase the time in 10 minute increments. Release  when the desired time appears in the display. The timer will begin to count down.
3. When the set time has run out, the Timer will sound with 3 beeps and will continue to beep 3 times every 60 seconds until **Timer Set/Off** key pad is pressed.

To change time remaining in Timer:

While the timer is active, press and hold the  or  key pad to increase or decrease any time remaining.

To cancel the Timer before the set time has run out:

Press **Timer Set/Off** key pad once.

Important notes:

- The timer does not start or stop the cooking process. It serves as an extra timer in the kitchen that will beep when the set time has run out. The timer may be used alone or when any other oven function is active.
- The indicator light located above the **Timer Set/Off** key pad will glow when the timer is active.
- The timer will display hours and minutes until 1 hour remains. When less than 1 hour remains, the display will count down in minutes and seconds. Once the timer has less than 1 minute remaining only seconds will display.
- If the timer is active when oven cooking, the minute timer will show in the display by default. To view information of any other **active** oven function, press the key pad once for the active function to view status.

Setting Oven Controls

Oven Lockout

The control may be programmed to lockout the oven control key pads and oven door.



To activate OVEN LOCKOUT feature:

1. Be sure oven door is completely closed.
2. Press and hold  key pad for 3 seconds. **Loc** will appear in the display. The **DOOR LOCKED** indicator light will flash and the motor driven door latch mechanism will begin locking the oven door automatically. Do not open the oven door at this time. Allow about 15 seconds for the oven door to completely lock. Once the oven door is locked, the time of day will appear in the display.

To cancel OVEN LOCKOUT feature:

1. Press and hold  key pad for 3 seconds. The **DOOR LOCKED** indicator light will flash and the motor driven door latch mechanism will begin to unlock the oven door. Do not open the oven door at this time. Allow about 15 seconds for the oven door to completely unlock.
2. The oven control key pads will be available and the oven door may be opened.

Important notes:







- To avoid possible damage to the oven door latch mechanism, **do not** attempt to open or close the oven door whenever the **DOOR LOCKED** indicator light is flashing.
- If a control key pad is pressed when OVEN LOCKOUT is active, **Loc** will appear in the display as a reminder that the key pad action is not available when the OVEN LOCKOUT feature is active.

Setting Bake

Use the bake function whenever the recipe calls for baking using normal temperatures. A reminder tone will sound when the set bake temperature is reached. Bake may be programmed for any temperature from 170°F to 550°F (77°C to 287°C). The factory preset bake temperature is 350°F (177°C).

CAUTION Always use pot holders or oven mitts when using the oven. When cooking, the oven interior, oven racks and cooktop will become very hot which can cause burns.



To set Bake:

1. Arrange oven racks and close oven door.
2. Press **Bake** key pad. — — —° appears in display.
3. Within 5 seconds, press  or . The display will show the default oven temperature of 350°F (177°C). By pressing  or , the oven temperature may be adjusted in 5°F increments (1°C if the control is set to display Celsius).
4. As soon as the  or  key pad is released, the oven will begin heating to the selected temperature. When the oven temperature reaches the set temperature, the PREHEAT indicator light will turn off and the oven control will beep 3 times.

To cancel bake at anytime:

Press .

To change the oven temperature after Bake has started:

1. Press **Bake** key pad. The current set oven temperature will display.
2. Press the  or  pad to increase or decrease the current set temperature to the new oven temperature.

Important notes:

- The oven will bake no longer than 12 hours. If you wish to continuously bake, see Changing between continuous bake setting or 12-Hour Energy Saving mode for detailed information.
- Dark or dull pans absorb more heat than shiny bakeware resulting in dark or overbrowning of foods. It may be necessary to reduce the oven temperature or cook time to prevent overbrowning of some foods. Dark pans are recommended for pies. Shiny pans are recommended for cakes, cookies and muffins.





Setting Oven Controls

Broil

Use the broil function to cook meats that require direct exposure to flame heat for optimum browning results. The Broil function is factory preset to broil at 550°F.

The suggested broil settings table (See Fig. 3) is provided for recommendations only. Increase or decrease broiling times, or move to a different rack position to suit for doneness. If the food you are broiling is not listed in the table, follow the instructions provided in your cookbook and watch the item closely.

To set Broil:

1. Arrange the oven racks when cool. For optimum browning results, preheat oven for 5 minutes before adding food.
2. Position cookware in oven. **Leave oven door open** at broil stop position when broiling (See Fig. 2).
3. Press **Broil** key pad. — — will appear in display.
4. Press  or  key pad until the desired broil setting level appears in the display. Press  for HI broil or  for LO broil setting. Most foods may be broiled at the HI broil setting. Select the LO broil setting to avoid excess browning or drying of foods that should be cooked to the well-done stage.
5. Broil on one side until food is browned. Turn and broil food on 2nd side.
6. When finished broiling press .

To cancel Broil at anytime press .

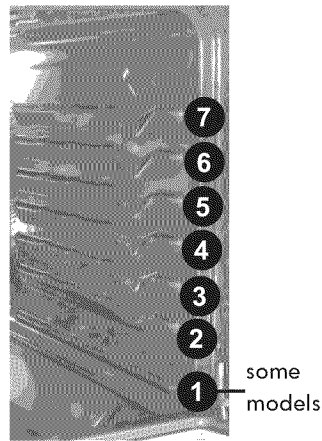

Fig. 1

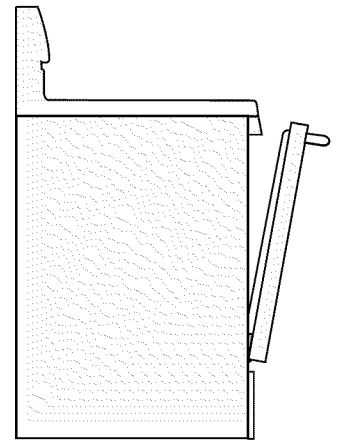

Fig. 2

⚠ WARNING Should an oven fire occur, close the oven door and turn the oven OFF. If the fire continues, use a fire extinguisher. **DO NOT** put water or flour on the fire. Flour may be explosive.

⚠ CAUTION Always use pot holders or oven mitts when using the oven. When cooking, the oven interior, exterior, oven racks and cooktop will become very hot which can cause burns

Important notes:

- Always arrange oven racks when the oven is cool.
- For best results when broiling, use a quality broil pan along with a broil pan insert. A broil pan is designed to drain the fat from the food, help avoid spatter and reduce smoking.
- When broiling, always pull the oven rack out to the stop position before turning or removing food.
- Cook Time or Delay Start will not operate with the Broil function.

Suggested broil settings table (electric oven)

Food	Rack position (See Fig. 1)	Setting	Cook time in minutes		Doneness
			1st side	2nd side	
Steak 1" thick	6th or 7th*	Hi	6	4	Medium
Steak 1" thick	6th or 7th*	Hi	7	5	Medium-well
Steak 1" thick	6th or 7th*	Hi	8	7	Well
Pork chops 3/4" thick	6th	Hi	8	6	Well
Chicken-bone in	5th	Lo	20	10	Well
Chicken-boneless	6th	Lo	8	6	Well
Fish	6th	Hi	- as directed -		Well
Shrimp	5th	Hi	- as directed -		Well
Hamburger 1" thick	6th or 7th*	Hi	9	7	Medium
Hamburger 1" thick	6th	Hi	10	8	Well

Cook times given are approximate and should be used only as a guide.

*Use the off-set rack only in rack position 7 (on some models).

Fig. 3





Setting Oven Controls

Adjusting Oven Temperature



Your appliance has been factory calibrated and tested to ensure an accurate baking temperature. For the first few uses, follow your recipe times and temperature recommendations carefully. If you think the oven is cooking too hot or too cool for your recipe times, you may adjust the control so the oven cooks hotter or cooler than the oven temperature displayed.

The oven temperature may be increased as much as +35°F (+19°C) or decreased -35°F (-19°C) from the factory calibrated settings.

To adjust oven temperature:

1. Press **Bake** key pad.
2. Set the oven temperature to 550°F (287°C) by pressing and holding the  key pad. Release when 550°F appears in display (287°C if control is set for Celsius display mode).
3. Within 2 seconds, press and hold **Bake** key pad until numeric digit(s) appear. Release **Bake** keypad. The display now indicates the amount of degrees offset from the original factory temperature setting and the current temperature setting. If the control still has the original factory calibration, the display will read 0.
4. The temperature may be adjusted up or down 35°F (19°C), in 5°F increments by pressing and holding the  or  key pads. Adjust until the desired amount of temperature offset appears in the display and release key pad.
5. Press  to accept and return to normal operation.

Important notes:

- Oven temperature adjustments made will not change the Broil or Select Clean operating temperatures.
- **DO NOT USE** oven thermometers such as those found in grocery stores to check the temperature settings inside your oven. These oven thermometers may vary as much as 20 to 40°F degrees from actual temperatures.
- The oven temperature adjustment may be made if your oven control has been set to display °C (Celsius) temperatures. Minimum and maximum settings for Celsius is plus (+) or minus (-) 19°C.
- If the display mode is set for Celsius, adjustments made will be in 1°C increments each press of the  or  key pads.

Select Clean

A self-cleaning oven cleans itself with high temperatures (well above normal cooking temperatures) which eliminate soils completely or reduces them to a fine powdered ash you can wipe away afterwards with a damp cloth.

The Select Clean function allows you to select 3 different cleaning times from 2, 3 or 4 hours. A 3-hour cleaning time is best used for normal cleaning; 2-hour time for light soils and a 4-hour clean time for heavier stubborn soils.

Read before starting Select Clean

Be sure to read all the following caution and important statements **BEFORE** starting a self-clean cycle:

⚠ CAUTION **DO NOT** leave small children unattended near the appliance. During the self-cleaning cycle, the outside of the range can become very hot to touch and can cause burns.

⚠ CAUTION **DO NOT** line the oven walls, racks, bottom or any other part of the range with aluminum foil. Doing so will destroy heat distribution, produce poor baking results and cause permanent damage to the oven interior. Aluminum foil will melt to the interior of the oven.

⚠ CAUTION The health of some birds is extremely sensitive to the fumes given off during the self-cleaning cycle of any range. Move birds to another well-ventilated room.

⚠ CAUTION **DO NOT** force the oven door open. This can damage the automatic door locking system.

⚠ CAUTION Use caution when opening the oven door after self-cleaning. **The oven may still be VERY HOT** and can cause burns. To avoid possible burns stand to the side of the oven when opening the oven door to allow hot air or steam to escape.

Important notes:

- Completely remove **ALL OVEN RACKS** and **ANY ACCESSORIES FROM OVEN CAVITY** to avoid damage to oven racks. If the oven racks are not removed they may discolor.
- Remove ALL items from the oven and cooktop including cookware, utensils and **ANY ALUMINUM FOIL**. Aluminum foil will not withstand high temperatures from a self-clean cycle and will melt.
- **DO NOT** use oven cleaners or oven protective coatings in or around any part of the oven interior.
- Clean any soil from the oven frame, the door liner outside the oven door gasket and the small area at the front center of the oven bottom (See Fig. 1). These areas heat sufficiently to burn soil on. Clean using soap and water prior to starting Select Clean (See Fig. 1).

- Remove any excessive spillovers. Any spills on the oven bottom should be wiped-up and removed before starting a self-clean cycle. To clean, use hot, soapy water and a cloth. Large spillovers can cause heavy smoke or fire when subjected to high temperatures. **DO NOT** allow food spills with a high sugar or acid content (such as milk, tomatoes, sauerkraut, fruit juices or pie filling) to remain on the surface as they may leave a dull spot even after cleaning.
- **DO NOT** clean the oven door gasket (See Fig. 1). The woven material of the oven door gasket is essential for a good seal. Care should be taken not to rub, damage or remove the gasket. **DO NOT** use any cleaning materials on the oven door gasket. Doing so could cause damage to the door gasket.

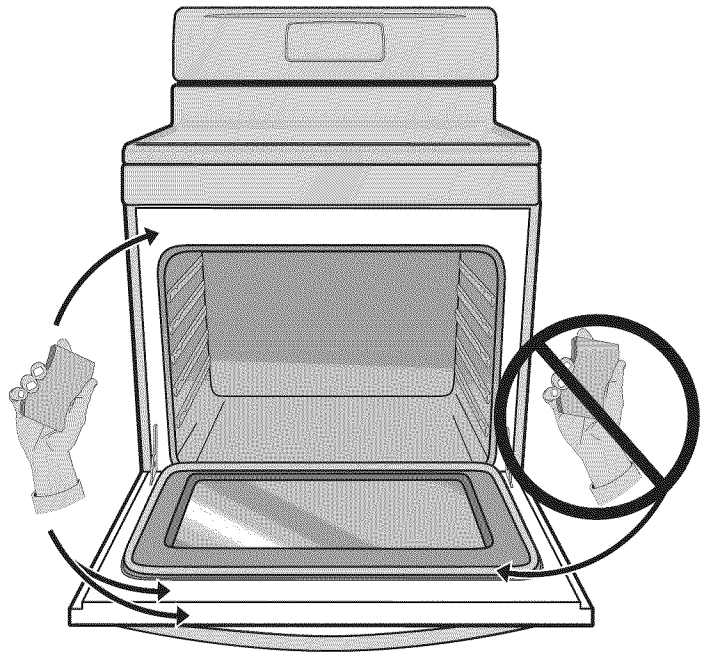

Fig. 1

Setting Select Clean

To set Select Clean to start immediately:

1. Be sure the oven is empty and **ALL** oven racks are removed. Remove all items from the cooktop. Be sure oven door is **completely** closed.
2. Press **Select Clean** key pad. — — — appears in the display.
3. Press **^** or **v** once. 3:00 appears in the display indicating the default 3 hour clean time is selected. To change to a 2 hour clean time press **v**; "2:00" appears in the display. To select a 4 hour clean time press **^**; "4:00" appears in the display.
4. After selecting the clean time Select Clean will activate. The **DOOR LOCKED** indicator light will glow and **CLn** will appear in the display.

Select Clean

When Select Clean begins the cleaning cycle, the motorized door latch mechanism will automatically start to lock the oven door and the DOOR LOCKED indicator light will flash. **DO NOT** open the oven door when the DOOR LOCKED indicator light is flashing. Allow about 15 seconds for the oven door to completely lock.

Once the oven door has locked the DOOR LOCKED indicator light will glow steady. When **CLn** will appears in the display Select Clean is active.

⚠ CAUTION Use caution when opening the oven door after self-cleaning. The oven may still be **VERY HOT and can cause burns**. To avoid possible burns stand to the side of the oven when opening the oven door to allow hot air or steam to escape.

When Select Clean is finished:

1. The time of day will appear in the display window and the Select Clean and DOOR LOCKED indicator lights will continue to glow.
2. Once the oven has cooled down (about 1 hour) and the DOOR LOCKED indicator light has turned off the oven door may be opened.
3. When the oven interior has completely cooled, wipe away any residue or powdered ash with a damp cloth or paper towel.

Important notes:

- The kitchen area should be well ventilated using an open window, ventilation fan or exhaust hood during the 1st self-clean cycle. This will help eliminate the normal odors associated with the 1st self-clean cycle.
- **DO NOT** attempt to open the oven door when the DOOR LOCKED indicator light is flashing. Allow about 15 seconds for the motorized door latch mechanism to completely lock or unlock the oven door.
- When the clean time finishes the oven door will remain locked until the range has cooled sufficiently. In addition to the clean time that was programmed, you must allow about 1 additional hour for the oven to cool before you will be able to open the oven door.
- The Select Clean function will not operate when oven lockout is active.

If it becomes necessary to stop Select Clean when active:

1. Press  .
2. If Select Clean has heated the oven to a high temperature, allow enough time for the oven to cool and for the DOOR LOCKED indicator light to turn off. When this indicator light turns OFF the oven door may be opened.
3. Restart Select Clean if needed.

Important notes:

- If Select Clean is active and a power failure occurs, the oven may not have thoroughly cleaned. This would depend on how much cleaning time had elapsed before the power failure. If needed after power is restored, set Select Clean again.

Care & Cleaning

Cleaning recommendation table

Surface type	Recommendation
Control knobs Painted body parts Painted decorative trim Aluminum, plastic or vinyl trim pieces	For general cleaning, use hot, soapy water and a cloth. For more difficult soils and built-up grease, apply a liquid detergent directly onto the soil. Leave on soil for 30-60 minutes. Rinse with a damp cloth and dry. Do not use abrasive cleaners on any of these materials; they can scratch. To remove control knobs, turn to OFF position; grasp firmly and pull straight off the shaft. To replace knobs after cleaning, line up the flat sides of both knob and shaft; then push knob into place.
Control panel Control key pad membrane Decorative trim (some models)	Before cleaning the control panel, turn all controls OFF, activate oven lockout (on some models) and if needed remove any knobs from panel. Do not use abrasive cleaners on any of these materials; they can scratch. Clean using hot, soapy water and a dishcloth. Be sure to squeeze excess water from dishcloth before wiping control panel; especially when wiping around the controls area. Excess water in or around the controls may cause damage to the appliance. When rinsing, use clean water and a dishcloth and be sure to squeeze excess water from dishcloth before wiping the control panel.
Porcelain enamel parts & door liner	Gentle scrubbing with a soapy no-scratch cleaning pad will remove most spots. Rinse with a 1:1 solution of clear water and ammonia. If necessary, cover difficult spots with an ammonia-soaked paper towel for 30 to 40 minutes. Rinse with clean water and a damp cloth, and then scrub with a soap-filled no-scratch cleaning pad. Rinse and wipe dry with a clean cloth. Do not allow food spills with high sugar or acid content (milk, tomatoes, sauerkraut, fruit juices or pie filling) to remain on the surface; they may cause a dull spot even after cleaning.
Oven interior	For oven interior remove excessive spillovers from oven cavity bottom before starting Select Clean. Clean any soils from oven frame and door liner outside the oven door gasket. For very important cleaning precautions be sure to read all the instructions in the Select Clean section.
Oven racks	Remove oven racks from oven cavity before starting Select Clean. Clean by using a mild, abrasive cleaner following manufacturer's instructions. Rinse with clean water, dry and then replace in oven.
Oven door	Use soap & water to thoroughly clean the top, sides and front of the oven door. Rinse well. You may use a glass cleaner on the outside glass of the oven door. Do not immerse the door in water. Do not spray or allow water or the glass cleaner to enter the door vents. Do not use oven cleaners, cleaning powders or any harsh abrasive cleaning materials on the outside of the oven door.
Surface elements and drip bowls	Do not use spray oven cleaners on the cooktop. See "Surface elements and drip bowls" in the Care & Cleaning section.
Stainless Steel (some models)	Only use cleaners and polishes that are specifically manufactured for cleaning stainless steel. Always rub in direction of metal grain to avoid damaging. Do not use cleaners with high concentrations of chlorides or chlorine. Do not use harsh scrubbing cleaners. Polish with a lint-free cloth. Always be sure to wipe excess cleaner/polish off from the metal surface as bluish stains may occur during future oven heating that cannot be removed. Clean heavier soils with hot, soapy water and a dishcloth. Rinse and dry using clean water and a cloth.

Care & Cleaning

General cleaning

Refer to the Cleaning recommendation table in the Care & Cleaning section for more detailed information about cleaning specific parts of the range.

⚠ CAUTION Before manually cleaning any part of the range, be sure all controls are turned OFF and the range is COOL. **The range may be hot** and can cause burns.

⚠ CAUTION Ammonia must be rinsed before operating the oven. Provide adequate ventilation.

Remove soils using hot, soapy water. Do not allow food spills with a high sugar or acid content (such as milk, tomatoes, sauerkraut, fruit juices or pie filling) to remain on the surface as they may cause a dull spot even after cleaning. Remove spillovers and heavy soiling as soon as possible. Regular cleaning will reduce the effort required for major cleaning later.

Cleaning oven bottom (some models)

⚠ CAUTION Oven elements may appear to have cooled after they have been turned off. The oven bake and broil elements **may still be hot** and burns may occur if touched before they have cooled sufficiently.

Please note:

On some models the lower oven bake element is visible. The following cleaning instruction applies **ONLY** for models that have a visible lower bake element.

The lower bake element may be tilted from the front for better access to the oven bottom for cleaning purposes. Be careful not to raise the element more than 4 or 5 inches from the resting position.

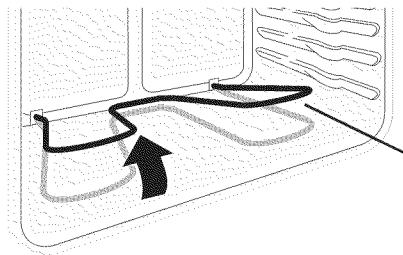

On models with visible bake element only; lower bake element may be raised from the front 4-5 inches to clean oven bottom.

Aluminum foil and utensils

⚠ WARNING NEVER cover any slots, holes or passages in the oven bottom or cover an entire oven rack with materials such as aluminum foil. Aluminum foil linings may trap heat, causing a fire hazard.

⚠ WARNING Protective liners — DO NOT USE ALUMINUM FOIL to line the oven bottom. — DO NOT USE aluminum foil to line surface drip bowls, or reflector pans. Only use aluminum foil as recommended in this manual. Improper installation of these liners may result in risk of electric shock, or fire.

Care & Cleaning

Surface elements and drip bowls

⚠ CAUTION Surface elements may appear to have cooled after they have been turned off. The surface elements **may still be hot** and burns may occur if touched before they have cooled sufficiently.

⚠ CAUTION Protective liners — Do not use aluminum foil to line surface drip bowls, or reflector pans. Only use aluminum foil as recommended in this manual. Improper installation of these liners may result in risk of electric shock, or fire.

Surface elements may be unplugged and removed to make cleaning the drip pans easier. The surface elements clean themselves when they are turned on. Food spilled on a hot element will burn off. Food spilled on a COOL element may be cleaned with a damp cloth — any remaining soil will burn off the next time the element is used.

To remove the surface elements and drip bowls:

1. Lift the edge of the drip bowl across from the terminal end. Lift the surface element and drip bowl together just enough to clear the cooktop.
2. While holding the drip bowl and surface element, gently pull the terminal end out from terminal plug (See Fig. 1).

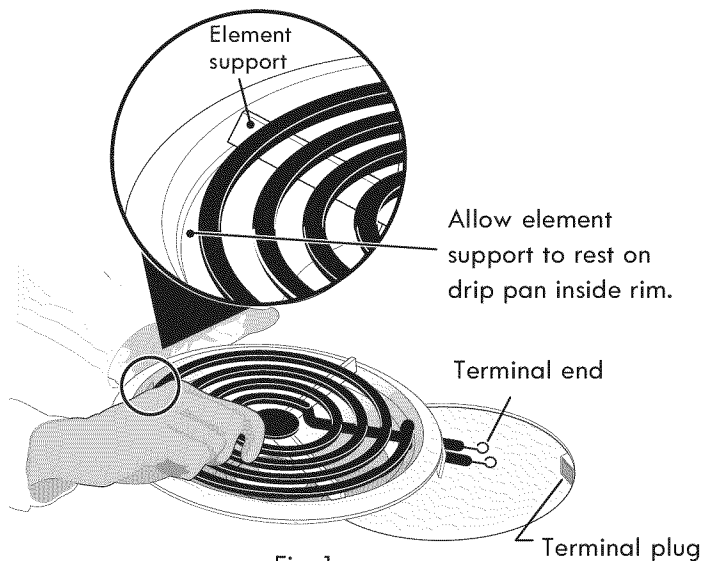

Fig. 1

Cleaning drip bowls

Wash in hot, soapy water or in the dishwasher. Rinse and dry while still warm. Hard to remove, burned on soil can be removed by soaking the drip bowls for about 20 minutes in a lightly diluted liquid cleanser or a solution of ammonia and water (1/2 cup ammonia to 1 gallon of water).

A no-scratch scrubbing pad may be used after soaking. DO NOT use abrasive cleaners or steel wool, they will scratch the surface. Always rinse with clean water and polish dry with a soft cloth.

To replace drip bowls and surface elements:

1. Slide the terminal end on the surface element through the opening in the drip bowl (Refer to Fig. 1).
2. Align the surface element support to rest on the rim inside the drip bowl.
3. After the surface element is positioned in the drip bowl, line up the terminal end with the terminal plug as shown (Fig. 1).
4. Hold the surface element and drip bowl together as level as possible and firmly push the terminal end into the terminal plug. Make sure element terminal is seated properly into terminal plug. Make sure the surface element is level to reduce the hazard of cookware sliding off the element.

Important notes:

- Be sure the range is cool before removing surface elements or drip bowls.
- **Never immerse a surface element in water.**
- **Make sure drip bowls are in place** - Absence of these bowls during cooking may subject wiring or components underneath to damage.
- Be careful not to bend terminal ends when replacing surface elements after cleaning.

Care & Cleaning

Raising and lowering the cooktop (some models)

⚠ WARNING To avoid possible burns **DO NOT** turn the surface elements on when the cooktop is raised. Be sure that the top is completely lowered and securely in place before turning on any of the surface burners.

⚠ CAUTION When lowering the lift-up range cooktop, grasp the sides with fingertips only. Be careful not to pinch fingers. **Do not** drop or bend the cooktop when raising or lowering. This may permanently damage the cooktop surface.

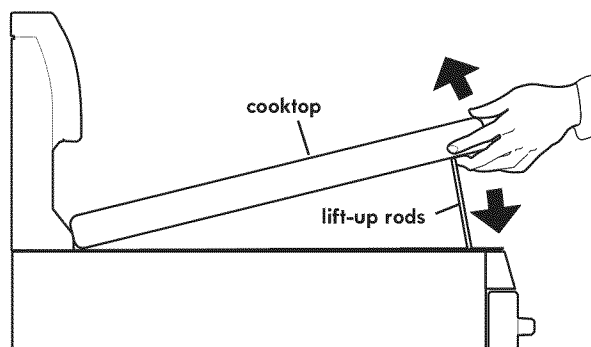

Fig. 1

To raise and lower the cooktop:

1. **Remove all items from cooktop** and set aside.
2. Grasp the sides of the cooktop and then lift from the front (See Fig. 1).
3. Lift the cooktop high enough to allow the support rods to snap into place. The **lift-up rods** will support the cooktop in the raised position.
4. If necessary, clean underneath using hot, soapy water and a clean cloth; then dry.
5. To lower the cooktop, grasp the front corner of each side of the top while pushing back on each rod with the heel of your hand. This will release the notched support. Hold the range cooktop and gently slide the top back down level to the range.

Replacing oven light (some models)

⚠ CAUTION Be sure the range is unplugged and all parts are **COOL** before replacing oven light. Wear a leather-faced glove for protection against possible broken glass.

The oven light is located at the rear of the oven cavity and is covered with a glass shield held by a wire holder. The glass shield protects the light bulb and must be in place whenever the oven is in use.

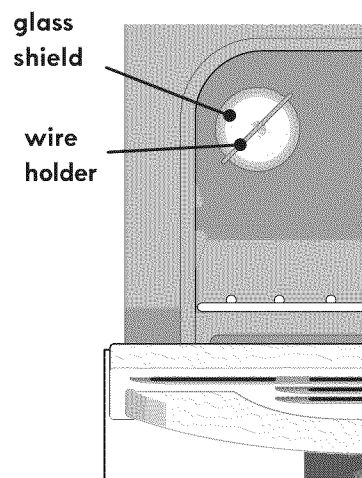

To replace the interior oven light bulb:

1. Turn electrical power off at the main source or unplug the range.
2. Press wire holder to one side to release the glass shield that covers the light bulb.
3. Replace light with a new 40 watt appliance bulb.
4. Replace glass shield over bulb and snap wire holder back into place.
5. Turn power on at the main source (or plug the appliance in).
6. The clock will then need to be reset. To reset, see **Setting clock** in this Use & Care Guide.

Care & Cleaning

Removing and replacing the lift-off oven door

⚠ CAUTION To avoid possible injury when removing or replacing the oven door, follow the instructions below **carefully** and always hold the oven door with both hands positioned **away from the door hinge area**.

⚠ CAUTION The door is heavy. For safe, temporary storage, lay the door flat with the inside of the door facing down.

To remove oven door:

1. Open oven door completely (horizontal with floor - Fig.1).
2. Pull the door hinge locks on both left and right door hinges down from the oven frame completely towards the oven door (Fig. 2). A tool such as a small flat-blade screwdriver may be required.
3. Firmly grasp both sides of oven door along the door sides (Do not use the oven door handle - Fig. 3).
4. Close the door to the broil stop position (the oven door will stop into this position just before fully closing).
5. With the oven door in the broil stop position, lift the oven door hinge arms over the roller pins located on each side of the oven frame (Fig. 4).

To replace oven door:

1. Firmly grasp both sides of oven door along the door sides (Do not use the oven door handle - Fig. 3).
2. Holding the oven door at the same angle as the removal position, seat the hook of the hinge arm over the roller pins located on each side of the oven door frame (Fig. 4). The hook of the hinge arms must be fully seated onto the roller pins.
3. Fully open the oven door (horizontal with floor - Fig. 1).
4. Push the door hinge locks up towards and into the oven frame on both left and right oven door hinges (Fig. 2) to the locked position; then close the oven door.

Special door care instructions

Most oven doors contain glass that can break. Read the following recommendations:

- Do not close the oven door until all the oven racks are fully in place inside the oven cavity.
- Do not hit the glass with pots, pans, or any other object.
- Scratching, hitting, jarring or stressing the glass may weaken its structure causing an increased risk of breakage at a later time.

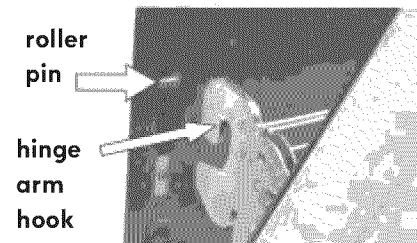
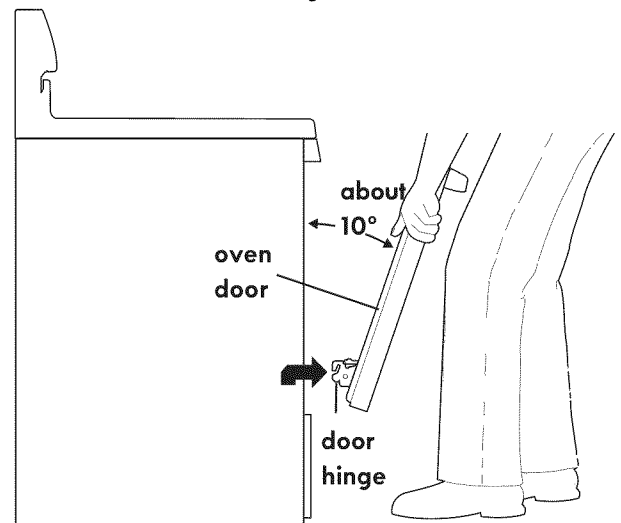
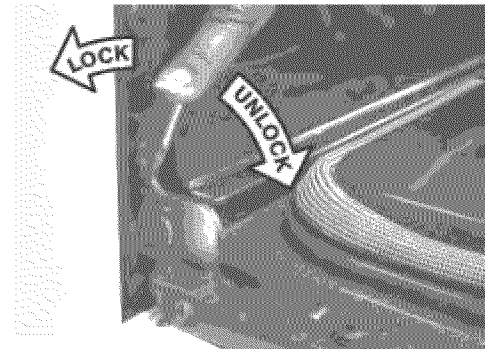
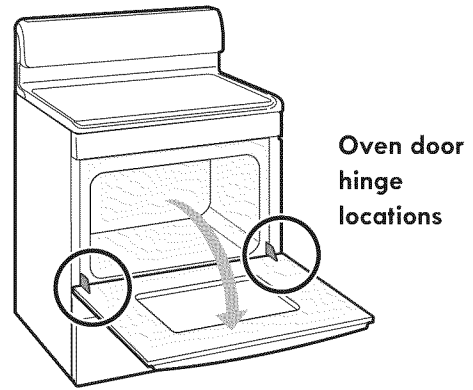



Before You Call • Solutions to common problems

Before you call for service, review the following list. It may save you time & expense. Possible solutions to these problems are provided with the problem listed:

Problem	Solution
Poor baking results.	<ul style="list-style-type: none">• Many factors affect baking results. Make sure the proper oven rack position is used. Center food in the oven and space pans to allow air to circulate. Allow the oven to preheat to the set temperature before placing food in the oven. Try adjusting the recipe's recommended temperature or baking time. If you feel the oven is too hot or cool, see Adjusting oven temperature in Setting Oven Controls section.
Appliance is not level.	<ul style="list-style-type: none">• Be sure floor is level, strong & stable enough to adequately support range.• If floor is sagging or sloping, contact a carpenter to correct the situation.• Poor installation. Place oven rack in center of oven. Place a level on the oven rack. Adjust leveling legs at base of appliance until the rack is level.• Kitchen cabinet alignment may make range appear not level. Be sure cabinets are square & have sufficient room for appliance clearance.
Cannot move appliance easily. Appliance must be accessible for service.	<ul style="list-style-type: none">• Cabinets not square or are built in too tightly. Contact builder or installer to make appliance accessible.• Carpet interferes with appliance. Provide sufficient space so appliance can be lifted over carpet.
Entire appliance does not operate.	<ul style="list-style-type: none">• Make sure power cord is plugged properly into outlet.• Electrical power outage. Check house lights to be sure. Call your local electric company for service outage information.• Service wiring is not complete. Call 1-800-4-MY-HOME® for assistance (See back cover).
Oven portion of appliance does not operate.	<ul style="list-style-type: none">• The time of day is not set. The time of day must first be set in order to operate the oven. See Setting clock in Setting Oven Controls section.• Be sure the oven controls are set properly for the desired function. See Setting Oven Controls section and review instructions for the desired cooking function in this manual or see "Entire appliance does not operate" in this checklist.
Surface element is too hot or not hot enough.	<ul style="list-style-type: none">• Incorrect surface control setting. Adjust power level setting.
Surface element does not heat or does not heat evenly.	<ul style="list-style-type: none">• Be sure the correct surface control knob is turned ON for element needed.• Lightweight or warped pans used. Use only flat, evenly balanced, medium or heavyweight cookware. Flat pans heat better than warped pans. Cookware materials and weight of the material affect heating. Heavy & medium-weight pans heat evenly. Because lightweight pans heat unevenly, foods may burn easily.
Oven light does not work.	<ul style="list-style-type: none">• Be sure the oven light is secure in the socket. Also see Replacing oven light in the Care & Cleaning section.

Before You Call • Solutions to common problems

Problem	Solution
Oven smokes excessively when broiling.	<ul style="list-style-type: none">• Incorrect setting. Follow broiling instructions in Setting Oven Controls section.• Be sure oven door is opened to broil stop position when broiling.• Meat too close to the broil element. Reposition the broil rack to provide proper clearance between the meat & the element. Preheat the broil element for searing.• Meat not properly prepared. Remove excess fat from meat. Cut remaining fatty edges to prevent curling, but do not cut into lean.• Grease has built up on oven surfaces. Regular cleaning is necessary when broiling frequently. Old grease or food spatters cause excessive smoking.
Flames inside oven or smoking from oven vent.	<ul style="list-style-type: none">• Excessive spillovers in oven. For example this will happen for pie spillovers or large amounts of grease left on the oven bottom. Wipe up excessive spillovers before starting oven. If flames or excessive smoke are present see Broil in Setting Oven Controls section.
Oven control panel beeps & displays any F code error.	<ul style="list-style-type: none">• Oven control has detected a fault or error condition. Press  key pad to clear the error code. Try Bake or Broil function. If the F code error repeats, remove power from appliance, wait 5 minutes and then repower appliance and set clock with the correct time of day. Try Bake or Broil function again. If the fault recurs, press  to clear and call 1-800-4-MY-HOME® for assistance (See back cover).
Select Clean does not work.	<ul style="list-style-type: none">• Oven control not set properly. Review instructions in Select Clean section.
Soil not completely removed after running Select Clean cycle.	<ul style="list-style-type: none">• Select Clean was interrupted. See Select Clean instructions.• Excessive spillovers on oven bottom. Remove before starting Select Clean.• Failure to clean soil from the oven frame, the door liner outside the oven door gasket and the small area at the front center of the oven bottom. These areas are not in the self-cleaning area, but get hot enough to burn on residue. Clean these areas before the self-cleaning cycle is started. Burned-on residue can be cleaned with a stiff nylon brush and water or a nylon scrubber. Be careful not to damage the oven gasket.
Oven racks discolored.	<ul style="list-style-type: none">• Oven racks left in oven cavity during Select Clean. Always remove oven racks from oven cavity before starting a self-clean cycle. Clean by using a mild, abrasive cleaner following manufacturer's instructions. Rinse with clean water, dry and replace in oven.

Before You Call • Solutions to common problems

Drip bowls are pitting or rusting.

- Foods with acids, such as tomatoes, if allowed to stand in/on bowls will cause corrosion. Remove and wash drip bowls as soon as possible after a spill over.
 - Normal environment. Along coastal areas, houses are exposed to high salt content in air. Protect bowls as much as possible from direct exposure to air with high salt content.
-

Drip bowls are turning color or distorted.

- Bottom surface of cookware extends beyond surface element and touches cooktop surface. This can cause high enough temperatures to discolor the drip bowls. DO NOT use cookware of this type. Pan sizes should be matched to the size of the element. Replacement drip bowls may be purchased from your appliance dealer.
-

Notes

Protection Agreements

Acuerdos de protección

Master Protection Agreements

Congratulations on making a smart purchase. Your new Kenmore® product is designed and manufactured for years of dependable operation. But like all products, it may require preventive maintenance or repair from time to time. That's when having a Master Protection Agreement can save you money and aggravation.

The Master Protection Agreement also helps extend the life of your new product. Here's what the Agreement* includes:

- ☑ **Parts and labor** needed to help keep products operating properly **under normal use**, not just defects. Our coverage goes **well beyond the product warranty**. No deductibles, no functional failure excluded from coverage – **real protection**.
- ☑ **Expert service** by a force of more than **10,000 authorized Sears service technicians**, which means someone you can trust will be working on your product.
- ☑ **Unlimited service calls and nationwide service**, as often as you want us, whenever you want us.
- ☑ **"No-lemon" guarantee** – replacement of your covered product if four or more product failures occur within twelve months.
- ☑ **Product replacement** if your covered product can't be fixed.
- ☑ **Annual Preventive Maintenance Check** at your request – no extra charge.
- ☑ **Fast help by phone** – we call it **Rapid Resolution** – phone support from a Sears representative on all products. Think of us as a "talking owner's manual".
- ☑ **Power surge protection** against electrical damage due to power fluctuations.
- ☑ **\$250 Food Loss Protection** annually for any food spoilage that is the result of mechanical failure of any covered refrigerator or freezer.
- ☑ **Rental reimbursement** if repair of your covered product takes longer than promised.
- ☑ **10% discount** off the regular price of any non-covered repair service and related installed parts.

Once you purchase the Agreement, a simple phone call is all that it takes for you to schedule service. You can call anytime day or night, or schedule a service appointment online.

The Master Protection Agreement is a risk free purchase. If you cancel for any reason during the product warranty period, we will provide a full refund. Or, a prorated refund anytime after the product warranty period expires. Purchase your Master Protection Agreement today!

Some limitations and exclusions apply. For prices and additional information in the U.S.A. call 1-800-827-6655.

*** Coverage in Canada varies on some items. For full details call Sears Canada at 1-800-361-6665.**

Sears Installation Service

For Sears professional installation of home appliances, garage door openers, water heaters, and other major home items, in the U.S.A. or Canada call 1-800-4-MY-HOME®.

Acuerdos maestros de protección

Enhorabuena por haber hecho una compra inteligente. Su nuevo producto Kenmore® está diseñado y fabricado para brindarle años de funcionamiento fiable. Pero, como cualquier producto, puede necesitar mantenimiento preventivo o reparaciones periódicas. Es por eso que tener un Acuerdo maestro de protección podría ahorrarle dinero y molestias.

El Acuerdo maestro de protección también sirve para prolongar la durabilidad de su nuevo producto. El acuerdo* incluye lo siguiente:

- ☑ **Piezas y mano de obra** necesarias para contribuir a mantener el funcionamiento adecuado de los productos **utilizados en condiciones normales de uso**, no sólo en caso de defectos de los productos. Nuestra cobertura va **mucho más allá que la garantía del producto**. No se aplican deducibles ni exclusiones por fallas del funcionamiento: es decir, **verdadera protección**.
- ☑ **Servicio técnico por expertos** (más de **10000 técnicos autorizados de Sears**), lo cual significa que quien repare o realice el mantenimiento de su producto será un profesional de confianza.
- ☑ **Servicio técnico a escala nacional y número ilimitado de llamadas de solicitud de servicio técnico**: se puede poner en contacto con nosotros cuantas veces lo desee y cuando lo desee.
- ☑ **Garantía "sin sorpresas"**: se reemplaza el producto cubierto por el acuerdo si ocurren cuatro o más fallas del producto en un periodo de 12 meses.
- ☑ **Reemplazo del producto**: en caso de que no se pueda reparar el producto cubierto por el acuerdo.
- ☑ **Revisión anual preventiva de mantenimiento del producto**: puede solicitarla en cualquier momento, sin costo alguno.
- ☑ **Rápida asistencia telefónica**, la cual denominamos **Solución rápida**: es decir, asistencia telefónica a través de cualquiera de nuestros representantes de Sears, sobre cualquiera de nuestros productos. Piense en nosotros como en un "manual parlante del usuario".
- ☑ **Protección contra fallas eléctricas**, contra daños debidos a fluctuaciones de la corriente eléctrica.
- ☑ **\$250 al año para cubrir cualquier posible deterioro de alimentos** que haya tenido que desechar debido a una falla mecánica de cualquiera de nuestros refrigeradores o congeladores cubiertos por este acuerdo.
- ☑ **Devolución de gastos de alquiler de electrodomésticos** si la reparación de su producto asegurado toma más que el tiempo prometido.
- ☑ **10% de descuento** aplicable tanto a los costos del servicio de reparación, como de las piezas instaladas relacionadas que no hayan quedado cubiertos por este acuerdo.

Una vez que haya realizado el pago de este acuerdo, bastará una simple llamada telefónica para concertar una visita de servicio. Puede llamar a cualquier hora del día o de la noche, o bien concertar una visita de servicio por Internet.

La adquisición del Acuerdo maestro de protección es una inversión exenta de riesgos. Si por cualquier motivo decide cancelar dicho acuerdo durante el periodo de garantía del producto, le haremos un reintegro total del valor. O bien un importe proporcional si cancela el acuerdo en cualquier otro momento posterior al vencimiento del periodo de garantía del producto. ¡Adquiera hoy mismo su Acuerdo maestro de protección!

Algunas limitaciones y exclusiones podrían aplicarse. Para solicitar precios e información adicional, llame al 1-800-827-6655 (en los EE.UU.).

*** La cobertura en Canadá varía en el caso de algunos artículos. Para obtener detalles completos al respecto, llame al 1-800-361-6665 de Sears de Canadá.**

Servicio de instalación de Sears

Para solicitar la instalación por profesionales de Sears de electrodomésticos, abridores de puertas de garaje, calentadores de agua y otros artículos de uso prioritario en el hogar, llame al 1-800-4-MY-HOME en los EE.UU. o Canadá.

Get it fixed, at your home or ours!

Your Home

For troubleshooting, product manuals and expert advice:



www.managemylife.com

For repair – **in your home** – of **all** major brand appliances, lawn and garden equipment, or heating and cooling systems, **no matter who made it, no matter who sold it!**

For the replacement parts, accessories and owner's manuals that you need to do-it-yourself.

For Sears professional installation of home appliances and items like garage door openers and water heaters.

1-800-4-MY-HOME[®] (1-800-469-4663)

Call anytime, day or night (U.S.A. and Canada)

www.sears.com www.sears.ca

Our Home

For repair of carry-in items like vacuums, lawn equipment, and electronics, call anytime for the location of your nearest

Sears Parts & Repair Service Center

1-800-488-1222 (U.S.A.)

www.sears.com

1-800-469-4663 (Canada)

www.sears.ca

To purchase a protection agreement on a product serviced by Sears:

1-800-827-6655 (U.S.A.)

1-800-361-6665 (Canada)

Para pedir servicio de reparación a domicilio, y para ordenar piezas:

1-888-SU-HOGAR[®]

(1-888-784-6427)

www.sears.com

Au Canada pour service en français:

1-800-LE-FOYER^{MC}

(1-800-533-6937)

www.sears.ca

The Sears logo, featuring the word "Sears" in a large, stylized, serif font with a shadow effect.

® Registered Trademark / TM Trademark of KCD IP, LLC in the United States, or Sears Brands, LLC in other countries

® Marca Registrada / TM Marca de Fábrica de KCD IP, LLC en Estados Unidos, o Sears Brands, LLC in otros países

^{MC} Marque de commerce / ^{MD} Marque déposée de Sears Brands, LLC

Free Manuals Download Website

<http://myh66.com>

<http://usermanuals.us>

<http://www.somanuals.com>

<http://www.4manuals.cc>

<http://www.manual-lib.com>

<http://www.404manual.com>

<http://www.luxmanual.com>

<http://aubethermostatmanual.com>

Golf course search by state

<http://golfingnear.com>

Email search by domain

<http://emailbydomain.com>

Auto manuals search

<http://auto.somanuals.com>

TV manuals search

<http://tv.somanuals.com>