



Electric Range

Slide-in models

Use & Care Guide

Estufa eléctrica

Modelos deslizables

Manual de uso y cuidado

Models, Modelos

790.4626*

* = Color number, número de color

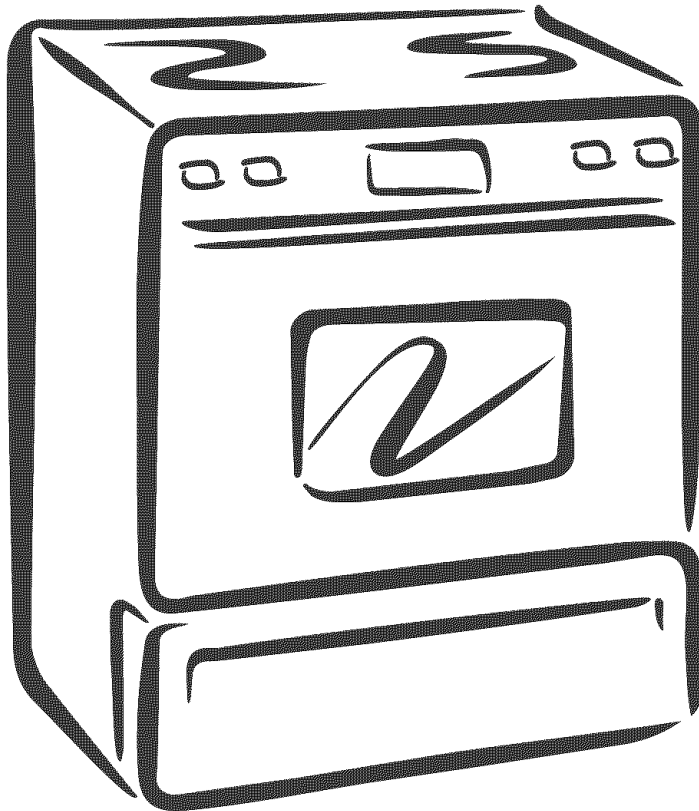

ENGLISH

ESPAÑOL

Table of Contents

Slide-in Range Warranty	2	Before Setting the Oven Controls	9
Product Record	2	Oven Control Functions	10
IMPORTANT SAFETY INSTRUCTIONS	3-5	Setting the Oven Controls	10-13
Protection Agreements	6	General Care & Cleaning	14-18
Range Features	7	Before you call	19-20
Setting Surface Controls	8	Notes	21
Selecting Surface Cooking Cookware	8	Sears Service	22

Kenmore Appliance Warranty

One Year Limited Warranty

When installed, operated and maintained according to all instructions supplied with the product, if this appliance fails due to a defect in material or workmanship within one year from the date of purchase, call **1-800-4-MY-HOME**® to arrange for free repair. If this appliance is used for other than private family purposes, this warranty applies for only 90 days from the date of purchase.

This warranty covers only defects in material and workmanship. Sears will NOT pay for:

1. Expendable items that can wear out from normal use, including but not limited to filters, belts, light bulbs, and bags.
2. A service technician to instruct the user in correct product installation, operation or maintenance.
3. A service technician to clean or maintain this product.
4. Damage to or failure of this product if it is not installed, operated or maintained according to all instructions supplied with the product.
5. Damage to or failure of this product resulting from accident, abuse, misuse or use for other than its intended purpose.
6. Damage to or failure of this product caused by the use of detergents, cleaners, chemicals or utensils other than those recommended in all instructions supplied with the product.
7. Damage to or failure of parts or systems resulting from unauthorized modifications made to this product.

Disclaimer of implied warranties; limitation of remedies

Customer's sole and exclusive remedy under this limited warranty shall be product repair as provided herein. Implied warranties, including warranties of merchantability or fitness for a particular purpose, are limited to one year or the shortest period allowed by law. Sears shall not be liable for incidental or consequential damages. Some states and provinces do not allow the exclusion or limitation of incidental or consequential damages, or limitations on the duration of implied warranties of merchantability or fitness, so these exclusions or limitation may not apply to you.

This warranty applies only while this appliance is used in the United States and Canada.

This warranty gives you specific legal rights, and you may also have other rights which vary from state to state.

Sears, Roebuck and Co., Dept. 817WA, Hoffman Estates, IL 60179

Sears Canada Inc., Toronto, Ontario, Canada M5B 2B8

Product Record

In this space below, record the date of purchase, model and serial number of your product. You will find the model and serial number printed on the serial plate.

Model No. _____

Serial No. 790. _____

Date of purchase _____

Save these instructions and your sales receipt for future reference.

Please carefully read and save these instructions

This Use & Care Manual contains general operating instructions for your appliance and feature information for several models. Your product **may not** have all the described features. The graphics shown are representative. The graphics on your appliance may not look exactly like those shown. Common sense and caution must be practiced when installing, operating and maintaining any appliance.

Serial Plate Location

You will find the model and serial number printed on the serial plate. The serial plate is located as shown below.

Remember to record the serial number for future reference.

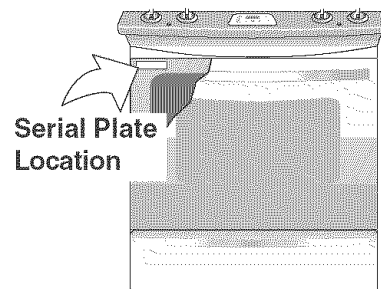

Important Safety Instructions

Read all instructions before using this appliance.

Save these instructions for future reference.

This manual contains many important safety messages. Always read and obey all safety messages.

The safety symbol  calls your attention to safety messages that inform you of hazards that can kill or hurt you or others, or cause damage to the product.

⚠ WARNING Indicates an imminently hazardous situation which, if not avoided may result in death or serious injury.

⚠ CAUTION Indicates an imminently hazardous situation which, if not avoided may result in minor or moderate injury, or product damage.

All safety messages will identify the hazard, tell you how to reduce the chance of injury, and tell you what can happen if the instructions are not followed.

- **Remove all tape and packaging before using the range.** Destroy the carton and plastic bags after unpacking the range. Never allow children to play with packaging material.
- **Proper Installation—Be sure your appliance is properly installed and grounded by a qualified technician in accordance with the National Electrical Code ANSI/NFPA No. 70 latest edition, and local code requirements.** Install only per installation instructions provided in the literature package for this range.

Sears Parts & Repair is the recommended repair service for this appliance. Know how to disconnect the electrical power to the appliance at the circuit breaker or fuse box in case of an emergency.

- **User servicing—Do not repair or replace any part of the appliance unless specifically recommended in the manuals.** All other servicing should be done only by a qualified technician. This may reduce the risk of personal injury and damage to the range.
- **Never modify or alter the construction of a range by removing leveling legs, panels, wire covers, anti-tip brackets/screws, or any other part of the product.**

⚠ WARNING Stepping, leaning or sitting on the door or drawer of this range can result in serious injuries and also cause damage to the range. Do not allow children to climb or play around the range. The weight of a child on an open door may cause the range to tip, resulting in serious burns or other injury. An open drawer, when hot, may cause burns.

⚠ WARNING Do not use the oven or warmer drawer (if equipped) for storage.

⚠ CAUTION Do not store items of interest to children in the cabinets above a range. Children climbing on the range to reach items could be seriously injured.

⚠ WARNING Never use your appliance for warming up or heating up the room.

- **Storage in or on appliance—Flammable materials should not be stored in an oven, near surface units or in the drawer (if equipped).** This includes paper, plastic and cloth items, such as cookbooks, plasticware and towels, as well as flammable liquids. Do not store explosives, such as aerosol cans, on or near the appliance. Flammable materials may explode and result in fire or property damage.

- **Do not leave children alone—Children should not be left alone or unattended in the area where appliance is in use.** They should never be allowed to sit or stand on any part of the appliance.

- **DO NOT TOUCH SURFACE UNITS, AREAS NEAR THESE UNITS, OVEN HEATING ELEMENTS OR INTERIOR SURFACES OF THE OVEN OR WARMER DRAWER (if equipped).** Both surface and oven heating elements may be hot even though they are dark in color. Areas near surface units may become hot enough to cause burns. During and after use, do not touch, or let clothing or other flammable materials touch these areas until they have had sufficient time to cool. Among these areas are the cooktop, surfaces facing the cooktop, the oven vent openings and surfaces near these openings, oven door and window.

**⚠ WARNING**

- All ranges can tip.
- Injury to persons could result.
- Install anti-tip device packed with range.
- See Installation Instructions.

To reduce the risk of tipping, the range oven must be secured by properly installed anti-tip bracket(s) provided with the range. To check if the bracket(s) is installed properly, remove the lower panel or storage drawer and verify that the anti-tip bracket(s) is engaged. Refer to the Installation Instructions for proper anti-tip bracket(s) installation.

Important Safety Instructions

- **Wear proper apparel**—Loose-fitting or hanging garments should never be worn while using the appliance. Do not let clothing or other flammable materials contact hot surfaces.
- **Do not use water or flour on grease fires**—Smother the fire with a pan lid, or use baking soda, a dry chemical or foam-type extinguisher.
- **When heating fat or grease, watch it closely.** Fat or grease may catch fire if allowed to become too hot.
- **Use only dry potholders**—Moist or damp potholders on hot surfaces may result in burns from steam. Do not let potholders touch hot heating elements. Do not use a towel or other bulky cloth instead of a potholder.
- **Do not heat unopened food containers**—Buildup of pressure may cause container to burst and result in injury.
- **Remove the oven door from any unused range if it is to be stored or discarded.**
- **Never leave surface burners unattended at high heat settings**—Boilovers cause smoking and greasy accumulations that may ignite, or a pan that has boiled dry may melt.
- **Protective liners**—Do not use aluminum foil to line oven bottom or any other part of the appliance. Only use aluminum foil as recommended for baking if used as a cover placed on the food. Any other use of protective liners or aluminum foil may result in a risk of electric shock or fire or short circuit.
- **Glazed cooking utensils**—Only certain types of glass, glass/ceramic, ceramic, earthenware, or other glazed utensils are suitable for rangetop service without breaking due to the sudden change in temperature. Check the manufacturer's recommendations for cooktop use.
- **Do not use decorative surface element covers.** If an element is accidentally turned on, the decorative cover will become hot and possibly melt. Burns will occur if the hot covers are touched. Damage may also be done to the cooktop.

IMPORTANT—Do not attempt to operate the oven during a power failure. If the power fails, always turn the oven off. If the oven is not turned off and the power resumes, the oven may begin to operate again. (Food left unattended could catch fire or spoil.)

⚠ CAUTION Electronic controllers can be damaged by cold temperatures. When you use your appliance for the first time, or if it has not been used for a long period of time, make sure that it has been exposed to a temperature above 0°C/32°F for at least 3 hours before connecting it to the power supply.

IMPORTANT INSTRUCTIONS FOR USING YOUR COOKTOP

- **Know which knob controls each surface heating unit.**
- **Use proper pan size.** This appliance is equipped with one or more surface units of different sizes. Select utensils having flat bottoms large enough to cover the surface unit. The use of undersized utensils will expose a portion of the surface heating unit to direct contact and may result in ignition of clothing. Proper relationship of utensil to the surface unit will also improve efficiency.
- **Utensil handles should be turned inward and not extend over adjacent surface units.** To reduce the risk of burns, ignition of flammable materials, and spillage due to unintentional contact with the utensil.

FOR COOKTOPS WITH COIL ELEMENTS ONLY

- **Do Not Immerse or Soak Removable Surface Heating Elements.** Surface heating elements should never be immerse in water. Heating elements clean themselves during normal operation.
- **Make Sure Drip Pans or Drip Bowls Are in Place.** Absence of these pans or bowls during cooking may subject wiring or components underneath to damage.

FOR GLASS COOKTOPS ONLY

- **Do not clean or operate a broken cooktop**—If cooktop should break, cleaning solutions and spillovers may penetrate the broken cooktop and create a risk of electric shock. Contact a qualified technician immediately.
- **Clean cooktop glass with caution**—If a wet sponge or cloth is used to wipe spills on a hot cooking area, be careful to avoid a steam burn. Some cleaners can produce harmful fumes if applied to a hot surface.
- **Avoid scratching the cooktop glass with sharp objects.**

IMPORTANT INSTRUCTIONS FOR USING YOUR OVEN

- **Use care when opening oven door or warmer drawer (if equipped)**—Stand to the side of the range when opening the door of a hot oven. Let hot air or steam escape before you remove or replace food in the oven / warmer drawer.

Important Safety Instructions

- **Keep oven vent ducts unobstructed.** The oven is vented through the right rear coil element. Touching the surfaces in this area when the oven is operating may cause severe burns. Also, do not place plastic or heat-sensitive items on or near the oven vent. These items could melt or ignite.
- **Placement of oven/warmer drawer (if equipped) Racks.** Always place oven racks in desired location while oven/warmer drawer (if equipped) is cool. If rack must be moved while oven is hot use extreme caution. Use potholders and grasp the rack with both hands to reposition. Do not let potholders contact the hot heating elements in the oven/warmer drawer (if equipped). Remove all utensils from the rack before moving.
- **Do not use the broiler pan without its insert.** The broiler pan and its insert allow dripping fat to drain and be kept away from the high heat of the broiler.
- **Do not cover the broiler insert with aluminum foil.** Exposed fat and grease could ignite.
- **Do not touch a hot light bulb with a damp cloth.** Doing so could cause the bulb to break. Disconnect the appliance or turn off the power to the appliance before removing and replacing light bulb.

IMPORTANT INSTRUCTIONS FOR CLEANING YOUR RANGE

- **Clean the range regularly to keep all parts free of grease that could catch fire.** Exhaust fan ventilation hoods and grease filters should be kept clean. Do not allow grease to accumulate on hood or filter. Greasy deposits in the fan could catch fire. When you are flaming food under the hood, turn the fan on. Refer to the hood manufacturer's instructions for cleaning.

SELF-CLEANING OVENS

- **In the self-cleaning cycle, only clean the parts listed in this Use and Care Guide.** Before self-cleaning the oven, remove the broiler pan and any utensils or foods from the oven.
- **Do not use oven cleaners**—No commercial oven cleaner or oven liner protective coating of any kind should be used in or around any part of the oven.
- **Do not clean door gasket**—The door gasket is essential for a good seal. Care should be taken not to rub, damage or move the gasket.
- **Remove oven racks.** Oven racks color will change if left in the oven during a self-cleaning cycle.

CAUTION The health of some birds is extremely sensitive to the fumes given off during the self-cleaning cycle of any range. Move birds to another well ventilated room.

IMPORTANT SAFETY NOTICE

The California Safe Drinking Water and Toxic Enforcement Act requires the Governor of California to publish a list of substances known to the state to cause cancer, birth defects or other reproductive harm, and requires businesses to warn customers of potential exposure to such substances.

SAVE THESE SAFETY INSTRUCTIONS

PROTECTION AGREEMENTS

In the U.S.A.

Master Protection Agreements

Congratulations on making a smart purchase. Your new Kenmore® product is designed and manufactured for years of dependable operation. But like all products, it may require preventive maintenance or repair from time to time. That's when having a Master Protection Agreement can save you money and aggravation.

Purchase a Master Protection Agreement now and protect yourself from unexpected hassle and expense.

The Master Protection Agreement also helps extend the life of your new product. Here's what's included in the Agreement:

- ✓ **Expert service** by our 12,000 professional repair specialists
- ✓ **Unlimited service and no charge** for parts and labor on all covered repairs
- ✓ **"No-lemon" guarantee** – replacement of your covered product if four or more product failures occur within twelve months
- ✓ **Product replacement** if your covered product can't be fixed
- ✓ **Annual Preventive Maintenance Check** at your request – no extra charge
- ✓ **Fast help by phone** – phone support from a Sears technician on products requiring in-home repair, plus convenient repair scheduling
- ✓ **Power surge protection** against electrical damage due to power fluctuations
- ✓ **Rental reimbursement** if repair of your covered product takes longer than promised

Once you purchase the Agreement, a simple phone call is all that it takes for you to schedule service. You can call anytime day or night, or schedule a service appointment on-line.

Sears has over 12,000 professional repair specialists, who have access to over 4.5 million quality parts and accessories. That's the kind of professionalism you can count on to help prolong the life of your new purchase for years to come. Purchase your Master Protection Agreement today!

Some limitations and exclusions apply.
For prices and additional information call
1-800-827-6655.

Sears Installation Service

For Sears professional installation of home appliances, garage door openers, water heaters, and other major home items, in the U.S.A. call
1-800-4-MY-HOME®

In Canada

Maintenance Agreements

Your purchase has added value because you can depend on Sears HomeCentral® for service. With over 2400 Service Technicians and more than a million parts and accessories, we have the tools, parts, knowledge and skills to ensure our pledge: We Service What We Sell.

Your Kenmore® product is designed, manufactured and tested to provide years of dependable operation. But like all products, it may require service from time to time. The Sears Maintenance Agreement offers you an outstanding service program, affordably priced.

The Sears Maintenance Agreement:

- Is your way to buy tomorrow's service at today's price
- Eliminates repair bills resulting from normal wear and tear
- Provides phone support from a Sears technician on products requiring in-home repair
- Even if you don't need repairs, provides an annual Preventive Maintenance Check, at your request, to ensure that your product is in proper running condition.

Some limitations apply. For more information about Sears Canada Maintenance Agreements, call 1-800-361-6665

Range features

Your Electric Range Features At a glance

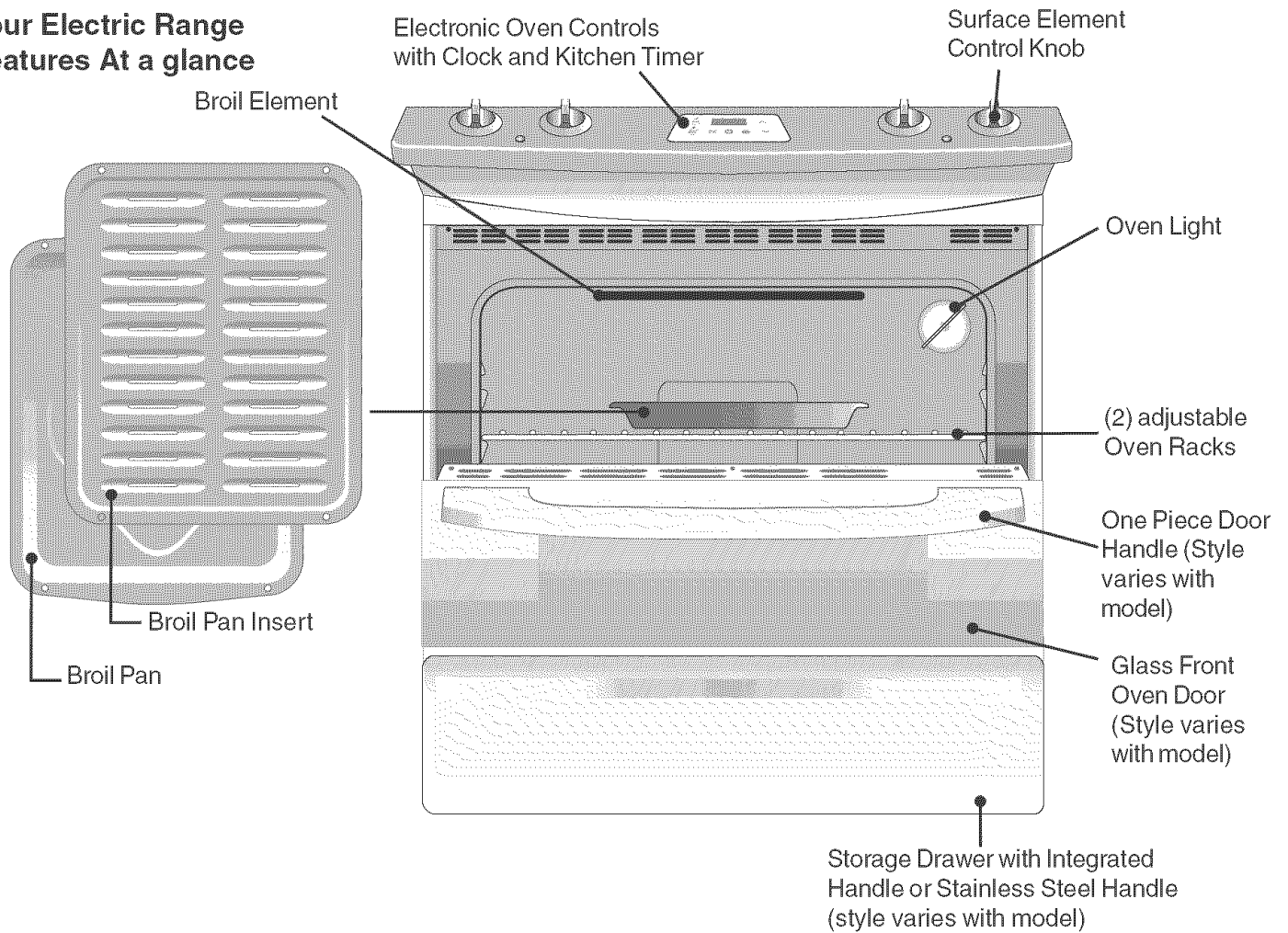

ENGLISH

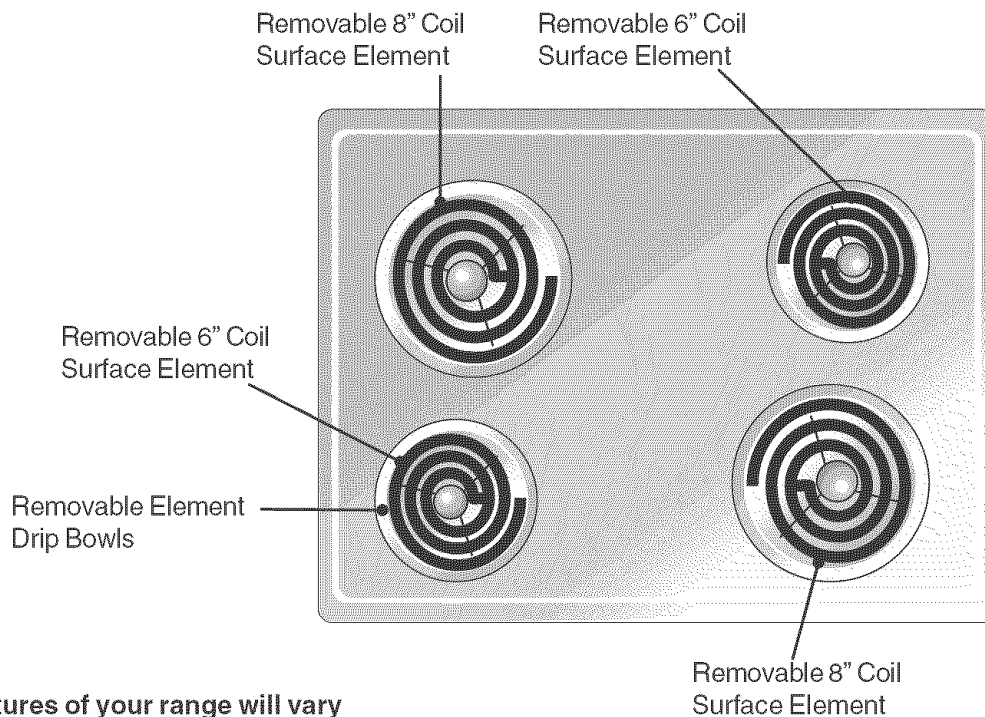

Note: The features of your range will vary according to model.

Setting Surface Controls

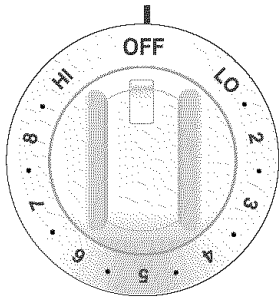

Note: The size and type of utensil used, and the amount and type of food being cooked will influence the setting needed for best cooking results.

Setting Surface Controls

1. Place the pan on the surface element.
2. Push in and turn the surface element control knob to desired setting.
3. The surface signal light will glow when one or more elements are turned on. Always turn the element off before removing the pan.

Setting	Type of Cooking
HI (MAX)	Start most foods, bring water to a boil, pan broiling.
5 (MED)	Maintain a slow boil, thicken sauces and gravies, steam vegetables.
2-4 (MED-LOW)	Keep food cooking, poach, stew.
LO (MIN)	Keep warm, melt, simmer.

*The suggested settings found in the chart above are based on cooking in medium thickness aluminum pans with lids. Settings may vary when using other types of pans.

CAUTION Do not place items such as salt and pepper shakers, spoon holders or plastic wrappings on top of the cooktop when it is in use. These items could melt or ignite. Potholders, towels or wood could catch fire if placed too close to the element.

Selecting Surface Cooking Cookware

Cookware should have flat bottoms that make good contact with the entire surface heating element. Check for flatness by rotating a ruler across the bottom of the cookware (See Figure 5). Be sure to follow the recommendations for using cookware as shown in Figure 6.

Note: The size and type of cookware used will influence the setting needed for best cooking results.

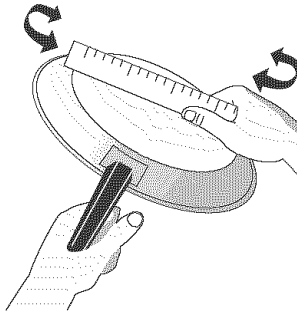
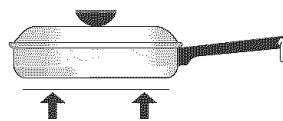

Figure 5

Correct



- Flat bottom and straight sides.
- Tight fitting lids.
- Weight of handle does not tilt pan. Pan is well balanced.
- Pan sizes match the amount of food to be prepared and the size of the surface element.
- Made of a material that conducts heat well.
- Easy to clean.
- Always match pot diameter to element surface diameter.

Incorrect

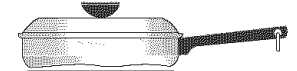

- Curved and warped pan bottoms.

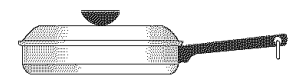

- Pan overhangs element by more than one-half inch.

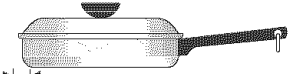

- Pan is smaller than element.

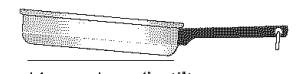

- Heavy handle tilts pan.

Figure 6

Cookware Material types

The cookware material determines how evenly and quickly heat is transferred from the surface element to the pan bottom. The most popular materials available are:

ALUMINUM - Excellent heat conductor. Some types of food will cause it to darken (Anodized aluminum cookware resists staining & pitting). If aluminum pans slide across the ceramic glass cooktop, they may leave metal marks which will resemble scratches. Remove these marks immediately.

COPPER - Excellent heat conductor but discolors easily. May leave metal marks on ceramic glass (see Aluminum above).

STAINLESS STEEL - Slow heat conductor with uneven cooking results. Is durable, easy to clean and resists staining.

CAST IRON - A poor heat conductor however will retain heat very well. Cooks evenly once cooking temperature is reached. Not recommended for use on ceramic cooktops.

PORCELAIN-ENAMEL on METAL - Heating characteristics will vary depending on base material. Porcelain-enamel coating must be smooth to avoid scratching ceramic cooktops.

GLASS - Slow heat conductor. Not recommended for ceramic cooktop surfaces because it may scratch the glass.

Before Setting Oven Controls

Oven Vent Location -Models with Coil Elements

The oven is vented **through the right rear coil element**. When the oven is on, warm air is released through the vent(s). This venting is necessary for proper air circulation in the oven and good baking results. **DO NOT** block the vent(s). Doing so may cause cooking failures, fire or damage to the appliance.

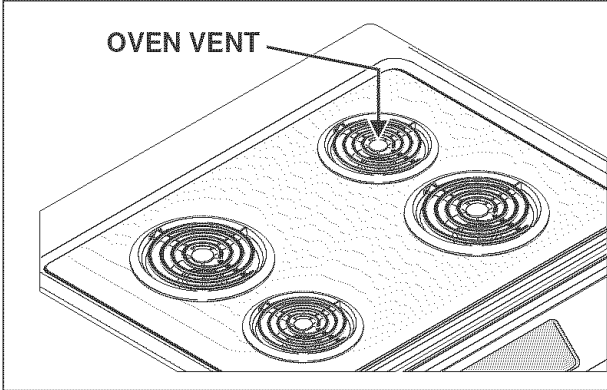

Removing and Replacing Oven Racks

To remove, pull the rack forward until it stops. Lift up front of rack and slide out. **To replace**, fit the rack onto the guides on the oven walls. Tilt the front of the rack upward and slide the rack back into place.

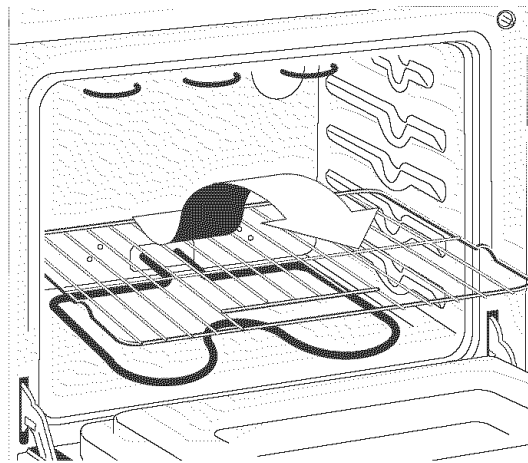

Arranging Oven Racks

ALWAYS ARRANGE OVEN RACKS WHEN THE OVEN IS COOL (PRIOR TO OPERATING THE OVEN). Always use oven mitts when the oven is hot.

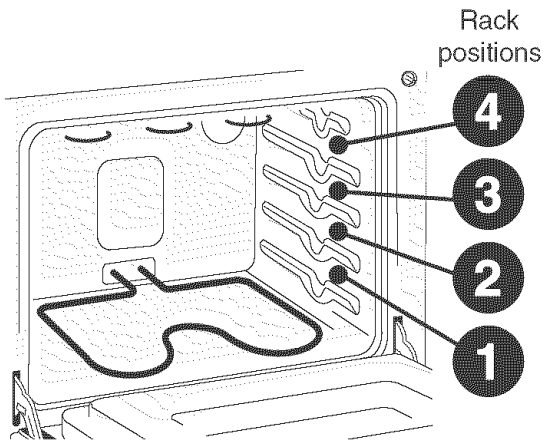

RECOMMENDED RACK POSITIONS FOR BROILING, BAKING & ROASTING

Food	Rack position
Broiling meats, chicken or fish	3 or 4
Cookies, cakes, pies, biscuits & muffins	
1 rack	2 or 3
Multiple racks	2 & 4
Frozen pies, angel food cake, yeast, bread, casseroles, small cuts of meat or poultry	1 or 2
Turkey, roast or ham	1

Note: Always use caution when removing food.

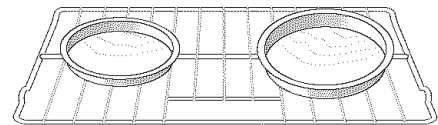

1 Oven Rack

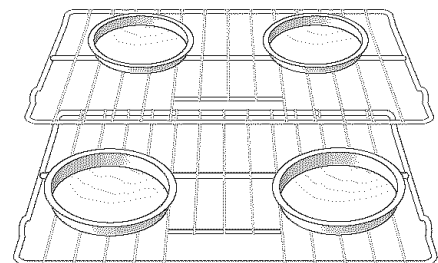

Multiple Oven Racks

Air Circulation in the Oven

For best air circulation and baking results allow 2-4" (5-10 cm) around the cookware for proper air circulation and be sure pans and cookware do not touch each other, the oven door, sides or back of the oven cavity. The hot air must circulate around the pans and cookware in the oven for even heat to reach around the food.

Oven Control Functions

READ THE INSTRUCTIONS CAREFULLY BEFORE USING THE OVEN. For satisfactory use of your oven, become familiar with the various functions of the oven as described below.

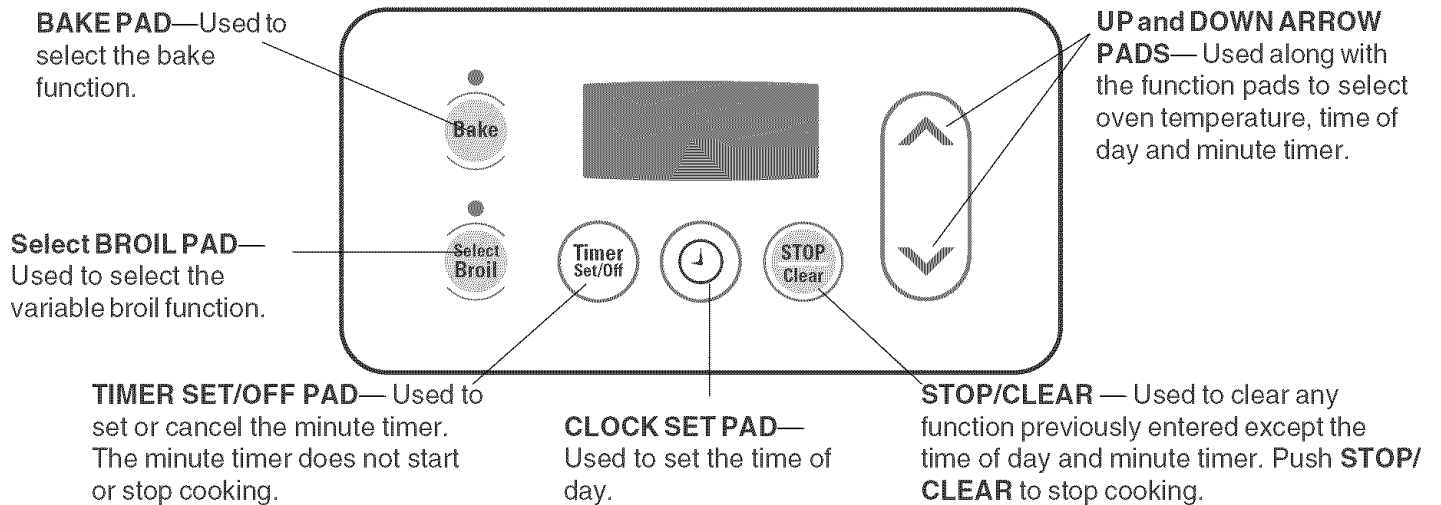



Note: The graphics on your timer may not look exactly like those shown. This doesn't change the way it operates.

Setting Oven Controls





Note: The time of day must first be set in order to operate the oven.

To Set the Clock

When the range is first plugged in, or when the power supply to the range has been interrupted, the display will flash "12:00".

1. Press .
2. Within 5 seconds, press and hold the  or  until the correct time of day appears in the display.

To Set the Minute Timer:

1. Press .
2. Press the  to increase the time in one minute increments. Press and hold the  to increase the time in 10 minute increments. The timer can be set for any amount of time from 1 minute to 11 hours and 59 minutes.
Note: If you press the  pad first, the timer will advance to 11 hours and 59 minutes.
3. The display shows the timer count down in minutes until one minute remains. Then the display will count down in seconds.
4. When the set time has run out, the timer will sound a 3 second beep. Then 0:00 will appear in the display until  is pressed.

Note: While the minute timer is counting down, the ":" will flash. The minute timer does not start or stop cooking. It serves as an extra timer in the kitchen that will beep when the set time has run out. The minute timer can be used alone or during any of the other oven functions. When the minute timer is in use with any other function, the minute timer will be shown in the display. To view other functions, press the pad for that function.

To Change the Minute Timer while it is in use:

While the timer is active and shows in the display, press and hold the  or  pad to increase or decrease the time.

To Cancel the Minute Timer before the set time has run out: Press .









Setting Oven Controls (cont'd)

Note: The time of day must first be set in order to operate the oven.



To Set or Change the Temperature for Baking

The oven can be programmed to bake at any temperature from 170°F to 500°F.

To Set the Controls for Baking:

1. Press . "— — —" appears in the display.
2. Within 5 seconds, press the  or . The display will show "350°". By pressing and holding the  or , the temperature can then be adjusted in 5°F increments.
3. When the  or  is released, the oven will begin heating to the selected temperature. When the oven temperature reaches the desired baking temperature, the control will beep one (1) time.
4. To cancel the baking function, press .

To Change the Oven Temperature after Baking has Started:



1. Press  and make sure the bake temperature is displayed.
2. Press the  or  to increase or decrease the set temperature.

Setting Oven Controls (cont'd)

Oven Baking Information

For best results, preheat the oven before baking cookies, breads, cakes, pies or pastries, etc. There is no need to preheat the oven for roasting meat or baking casseroles.

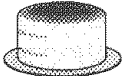
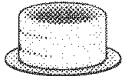
The cooking times and temperatures needed to bake a product may vary slightly from your previously owned appliance.

Baking problems and solutions		
Baking Problems	Causes	Corrections
Cookies and biscuits burn on the bottom. 	<ul style="list-style-type: none"> • Cookies and biscuits put into the oven before the preheating time is completed. • Oven rack overcrowded. • Dark pan absorbs heat too fast. 	<ul style="list-style-type: none"> • Allow oven to preheat to the selected temperature before placing food in oven. • Choose pan sizes that will permit 2" to 4" (5.1 cm to 10.2 cm) of air space on all sides when placed in the oven. • Use a medium-weight aluminum baking sheet.
Cakes too dark on top or bottom. 	<ul style="list-style-type: none"> • Cakes put into the oven before preheating time is completed. • Oven rack position too high or low. • Oven too hot. 	<ul style="list-style-type: none"> • Allow oven to preheat to the selected temperature before placing food in the oven. • Use proper rack position for baking needs. • Set oven temperature 25°F/12°C lower than recommended.
Cakes not done in the center. 	<ul style="list-style-type: none"> • Oven too hot. • Incorrect pan size. • Pan not centered in the oven. 	<ul style="list-style-type: none"> • Set oven temperature 25°F/12°C lower than recommended. • Use pan size suggested in recipe. • Use proper rack position and place pan so there is 2" to 4" (5.1 cm to 10.2 cm) of space on all sides of pan.
Cakes not level. 	<ul style="list-style-type: none"> • Range not level. • Pan too close to oven wall or rack overcrowded. • Pan warped. 	<ul style="list-style-type: none"> • Place marked glass measuring cup filled with water on the center of the oven rack. If water level is uneven, refer to the installation instructions for leveling the appliance. • Be sure to allow 2" to 4" (5.1 cm to 10.2 cm) of clearance on all sides of each pan in the oven. • Do not use pans that are dented or warped.
Foods not done when cooking time is up. 	<ul style="list-style-type: none"> • Oven too cool. • Oven overcrowded. • Oven door opened too frequently. 	<ul style="list-style-type: none"> • Set oven temperature 25°F/12°C higher than suggested and bake for the recommended time. • Be sure to remove all pans from the oven except the ones to be used for baking. • Open oven door only after shortest recommended baking time.





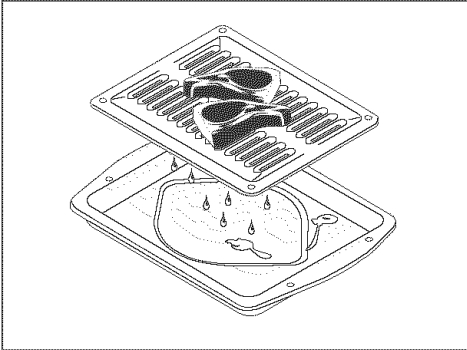

Setting Oven Controls (cont'd)

The broiler pan and its insert allow dripping grease to drain and be kept away from the high heat of the broiler. **DO NOT** use the pan without its insert. **DO NOT** cover the insert with foil. The exposed grease could ignite.



To Broil

Note: For optimum browning results when broiling, preheat the broil element for 3 to 4 minutes.

1. Arrange oven rack while oven is still cool.
2. Press .
3. Press the  or  pad, **nor** will appear in the display indicating the oven is set for a **normal** broil. Press again the  pad for HI broil or the  pad for LO broil. Most foods can be broiled at the HI broil setting. Select the LO broil setting to avoid excess browning or drying of foods that should be broiled to the well-done stage.
4. Place the insert on the broiler pan, then place the food on the insert. **DO NOT** use the broiler pan without the insert or cover the insert with aluminum foil. The exposed grease could ignite.
5. Place the pan on the oven rack. **Open the oven door to the broil stop position when broiling** (see illustration).
6. Broil on one side until food is browned; turn and cook on the second side.
Note: Always pull the rack out to the stop position before turning or removing food.
7. When broiling is finished, press .

Broil Rack Position Table (Refer to Figure 3)

Note: It is recommended to cook food from 3" to 5" of the broil element.

Rack Position	Food category
3rd rack position	Medium-rare steaks & hamburgers
2nd rack position	Fish, medium steaks & pork chops
2nd rack position	Well-done foods such as chicken & lobster

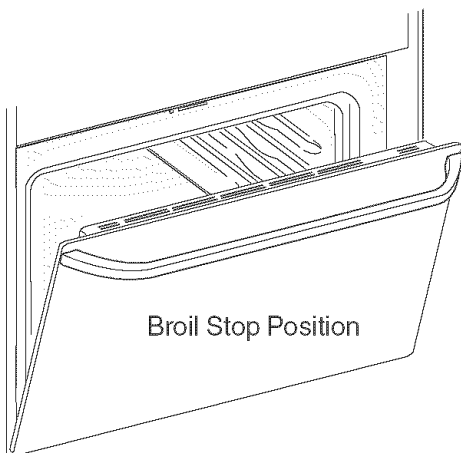

CAUTION Should an oven fire occur, close the oven door and turn off the oven. If the fire continues, use a fire extinguisher. **DO NOT** put water or flour on the fire. Flour may be explosive.

Broiling Tips

Broil on one side until the food is browned; turn and cook on the second side. Season and serve. **Always pull rack out to the "stop" position before turning or removing food.**

Broiling times vary, so watch the food closely. Time not only depends on the distance from the element, but on the thickness and age of meat, fat content and doneness preferred. The first side usually requires a few minutes longer than the second. Frozen meats also require additional time.

Broiler Clean-Up Tips:

- To make cleaning easier, line bottom of the broiler pan with aluminum foil. **DO NOT** cover the broiler grid with foil.
- To prevent grease from baking on, remove the broiler pan from the oven as soon as cooking is completed. Use hot pads because the broiler pan is extremely hot. Pour off grease. Soak the pan in **HOT**, soapy water.
- Clean the broiler pan as soon as possible after each use. If necessary, use soap-filled steel wool pads. Heavy scouring may scratch the grid.

General Care & Cleaning

Cleaning Various Parts of Your Range

Before cleaning any part of the range, be sure all controls are turned OFF and the range is cool. **Remove spillovers and heavy soiling as soon as possible. Regular cleanings now will reduce the extent and difficulty of major cleaning later.**

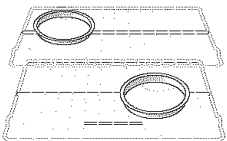
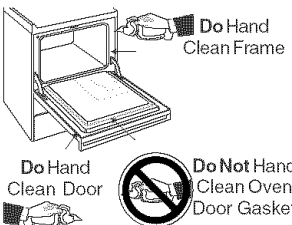
Surfaces	How to Clean
Aluminum & Vinyl Control Panel and Trim Pieces	Use hot, soapy water and a cloth. Dry with a clean cloth. Before cleaning the control panel, turn all controls to OFF and remove the control knobs. To remove, pull each knob straight off the shaft. Clean using hot, soapy water and a dishcloth. Rinse with a clean water and a dishcloth. Be sure to squeeze excess water from the cloth before wiping the panel; especially when wiping around the controls. Excess water in or around the controls may cause damage to the appliance. Be sure to rinse the cleaners as bluish stains may occur during heating and cannot be removed. To replace knobs after cleaning, line up the flat sides of both the knob and the shaft; then push the knob into place.
Glass, Painted and Plastic Body Parts, Control Knobs and Decorative Trim Pieces	Using a soft cloth, clean with mild dish detergent and water or a 50/50 solution of vinegar and water. Follow by rinsing the area with clean water; dry and polish with a soft cloth. Glass cleaners may be used if sprayed on a soft cloth first. DO NOT spray liquids directly on the control pad and display area. Do not use large amounts of water on the control panel - excess water on the control area may cause damage to the appliance. Do not use other liquid cleaners, abrasive cleaners, scouring pads, or paper towels - they will damage the finish. To remove control knobs, turn to the OFF position; grasp firmly and pull straight off the shaft. To replace knobs after cleaning, line up the flat sides of both the knob and the shaft; then push the knob into place.
Stainless Steel (some models) Oven door & drawer front panel	Clean with hot, soapy water and dishcloth. Rinse with clean water and cloth. Do not use cleaners with high concentrations of chlorides or chlorines. Do not use harsh scrubbing cleaners. Only use kitchen cleaners that are especially made for cleaning stainless steel. Always be sure to rinse the cleaners off from the surface as bluish stains may occur during heating that cannot be removed.
Porcelain Enamel Broiler Pan and Insert, Door Liner, Body Parts and Warmer Drawer and Drawer Cavity.	Gentle scouring with a soapy scouring pad will remove most spots. Rinse with a 1:1 solution of clear water and ammonia. If necessary, cover difficult spots with an ammonia-soaked paper towel for 30 to 40 minutes. Rinse with clean water and a damp cloth, and then scrub with a soap-filled scouring pad. Rinse and wipe dry with a clean cloth. Remove all cleaners or the porcelain may become damaged during future heating. DO NOT use spray oven cleaners on the cooktop.
Oven Racks 	Remove racks. See "Removing and Replacing Oven Racks" under Before Setting Oven Controls . Use a mild, abrasive cleaner, following manufacturer's instructions. Rinse with clean water and dry. After cleaning the racks, rub the sides of the racks with wax paper or a cloth containing a small amount of baby oil or salad oil (this will make the racks glide easier into the rack positions).
Oven Door 	Use soap & water to thoroughly clean the top, sides and front of the oven door. Rinse well. You may use a glass cleaner on the outside glass of the oven door. DO NOT immerse the door in water. DO NOT spray or allow water or the glass cleaner to enter the door vents. DO NOT use oven cleaners, cleaning powders or any harsh abrasive cleaning materials on the outside of the oven door. DO NOT clean the oven door gasket. The oven door gasket is made of a woven material, on Self-Cleaning models, which is essential for a good seal. Care should be taken not to rub, damage or remove this gasket.

Surface Elements and Drip Bowls (Models with Coil Surface Elements)

Surface elements can be unplugged and removed to make cleaning the drip bowls easier. The surface elements clean themselves when they are turned on. Food spilled on a hot element will burn off. Food spilled on a cold element can be cleaned with a damp cloth—any remaining soil will burn off the next time element is used. **NEVER IMMERS A SURFACE ELEMENT IN WATER.** To remove surface element and drip bowls, follow the instructions under **General Care & Cleaning**.

To clean drip bowls, wash in hot, soapy water or in the dishwasher. Rinse and dry while still warm. Hard-to-remove, burned-on soils can be removed by soaking the drip bowls for about 20 minutes in a slightly diluted liquid cleanser or solution made of equal parts ammonia and water. A nylon scrubber may be used after soaking. **DO NOT** use abrasive cleanser or steel wool, as they will scratch the surface. Always rinse with clean water and polish, and dry with a soft cloth. To replace drip bowls and surface elements, follow the instructions under **General Cleaning**.

General Care & Cleaning (cont'd)

Porcelain Enamel Cooktop Cleaning Instructions

⚠ WARNING Do not use a cooktop cleaner on a hot cooktop. The fumes can be hazardous to your health, and can chemically damage the cooking surface.

⚠ CAUTION Before cleaning the surface cooktop, be sure the controls are turned to OFF and the cooktop is cool.

⚠ CAUTION DO NOT use commercial oven cleaners on the exterior surfaces including rangetop and door frame.

Correct and consistent cleaning is essential to maintaining your porcelain enamel cooktop. If food spills and grease spatters are not removed, they may burn onto the surface of the cooktop and cause permanent discoloration.

Daily Cleaning

For normal soil:

1. Allow cooktop surface to cool.
2. Wipe off spills and spatters using a clean paper towel or a clean cloth with warm, soapy water.
3. If needed, use a soapy non abrasive pad or other mild household cleaners.
4. Be sure to rinse off the cleaners or the porcelain may become damaged during future heating.

For heavy, burned-on soil:

1. Allow cooktop surface to cool.
2. Use a soap filled scouring pad with warm water or cover heavily soiled spots with a solution of clear water and ammonia. Scour gently. Rinse and wipe dry with a clean cloth.
3. If any soil remains, apply a few drops of a recommended cooktop cleaning cream on the spots and rub gently using a clean damp cloth or scouring pad. Buff with a dry cloth until all soil and cream are removed. Frequent cleaning with the cooktop cleaning cream leaves a protective coating which helps in preventing scratches and abrasions.

For sugary spillovers:

Sugary spills can chemically damage your cooktop surface. Therefore, you must begin cleaning the spills while the cooktop is still hot. Use caution when following the steps below.

1. Turn off all surface units and remove all pans immediately.
2. Put on an oven mitt, wipe up carefully or move hot spills away from the element area with a clean damp cloth.
3. Allow the cooktop to cool. Follow the instructions above for heavy, burned-on soil.

SURFACES	CLEANING AGENTS	INSTRUCTIONS
Porcelain enamel (cooktop, surface under cooktop)	Mild cleaners or a soapy non abrasive pad.	Use a damp sponge or dampened soap pad, rinse and dry.
Broil Insert Control Panel	Hot, soapy water or cleaner cream.	Use a clean soapy, dampened cloth or paper towel, remove soil and dry. Do not use abrasive products.

Coil Surface Element

To Remove and Replace Surface Elements and Drip Bowls

ATTENTION: Never leave lids on the coil elements as they could be permanently damaged if the coil is turned on by accident.

Prior to cleaning the drip bowls make sure the coil elements are cold and the control knobs are turned to OFF

Coil elements clean themselves when they are turned on.

Coil elements and drip bowls are removable and allow you to clean the drip bowls.

To remove a coil element, push against the front edge and lift element up and out.

To clean by hand, wash the drip bowls in hot sudsy water. For hard to remove spots, use nylon scrubber with soap. Rinse and dry while still warm.

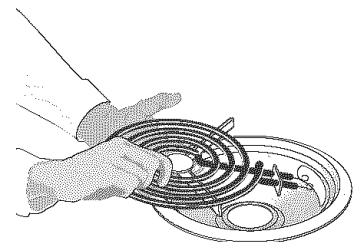

⚠ CAUTION Never immerse coil elements in water.

⚠ CAUTION Be careful not to bend terminal ends when replacing elements after cleaning.

General Care & Cleaning (cont'd)

To Raise the Top for Cleaning

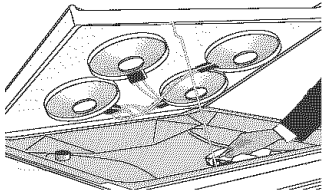

A rod swings up to support the top for cleaning underneath.

1. Grasp the sides and lift from the front. A lift-up rod will support the top in its raised position. Only lift the top high enough to allow the support rod to rest in place under the front of the cooktop.
2. Clean underneath using a clean cloth and hot, soapy water.
3. To lower the top, lift the top slightly and lower the rod. Lower the range top down into the range frame.

CAUTION When lowering the lift-up range top, grasp the sides with fingertips only. Be careful not to pinch fingers. **DO NOT** drop or bend the range top when raising or lowering. This could damage the surface.

Care and Cleaning of Stainless Steel (Stainless Steel models only)

Some models are equipped with stainless steel exterior parts. Special care and cleaning are **required** for maintaining the appearance of stainless parts. Please refer to the table provided at the beginning of the **General Care & Cleaning** section in this Use & Care Guide.

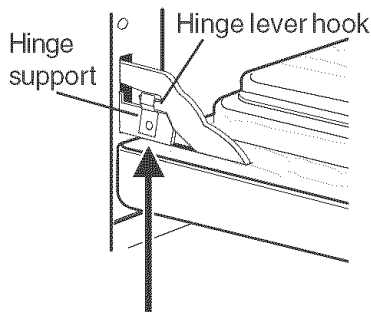

Lock engaged for door removal
Figure 1

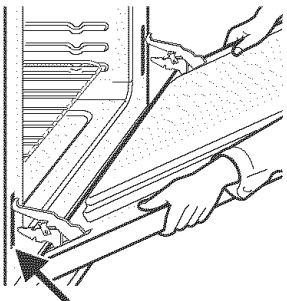

HINGE SLOT - Door removed
from the oven
Figure 2

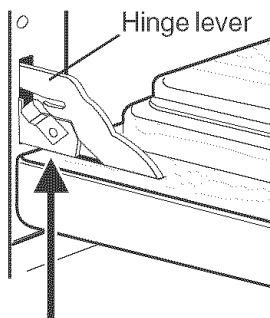

Lock in normal position
Figure 3

Removing and Replacing the Oven Door

CAUTION The door is heavy. For safe, temporary storage, lay the door flat with the inside of the door facing down.

To Remove Oven Door:

1. Open the door to the fully opened position.
2. Pull up the lock located on both hinge supports and engage it in the hinge lever hooks (Figure 1). You may have to apply a little downward pressure on the door to pull the locks fully over the hinge lever hooks.
3. Grab the door by the sides and pull the bottom of the door up and toward you to disengage the hinge supports. Keep pulling the bottom of the door toward you while rotating the top of the door toward the range to completely disengage the hinge levers (Figure 2).
4. To clean oven door, follow the instructions provided in the **General Care & Cleaning** table.

To Replace Oven Door:

1. Grab the door by the sides; place the hinge supports in the hinge slots. Open the door to the fully opened position.
2. Disengage the lock from the hinge lever hooks on both sides (Figure 3).
Note: Make sure the hinge supports are fully engaged before unlocking the hinge levers.
3. Close the oven door.

Special Door Care Instructions - Most oven doors contain glass that can break.

Read the following recommendations:

1. Do not close the oven door until all the oven racks are fully in place.
2. Do not hit the glass with pots, pans, or any other object.
3. Scratching, hitting, jarring or stressing the glass may weaken its structure causing an increased risk of breakage at a later time.

General Care & Cleaning (cont'd)

Porcelain Enamel Oven Cleaning

Porcelain has a smooth finish and is a type of glass fused to metal. Oven cleaners can be used on all interior oven porcelain surfaces.

General Cleaning

Remove soils using hot, soapy water. Do not allow food spills with a high sugar or acid content (such as milk, tomatoes, sauerkraut, fruit juices or pie filling) to remain on the surface as they may cause a dull spot even after cleaning.

To Remove Heavy Soil

1. Allow a dish of ammonia to sit in the oven overnight or for several hours with the oven door closed. Clean softened spots using hot, soapy water. Rinse well with water and a clean cloth.
2. If soil remains, use a soap-filled scouring pad or a nonabrasive cleaner. If necessary, use an oven cleaner following manufacturer's instructions. **DO NOT** mix ammonia with other cleaners.

Adhere to the following precautions when using oven cleaners:

1. **DO NOT** spray on the electrical controls or switches because it could cause a short circuit and result in sparking or fire.
2. **DO NOT** allow a film from the cleaner to build up on the temperature sensing bulb located at the top left rear corner of the oven; it could cause the oven to heat improperly. Carefully wipe the bulb clean after each oven cleaning, being careful not to move the bulb. A change in its position could affect how the oven bakes. Avoid bending the bulb and capillary tube.
3. **DO NOT** spray any cleaner on the oven door trim or gasket, handles or any exterior surfaces of the range, wood or painted surfaces. The cleaner can damage these surfaces.
4. **DO NOT** clean the oven door gasket. Care should be taken not to rub, damage or remove this gasket.

To Clean the Oven Bottom

The bake element is designed to be gently tilted using your hand from the front of the bake element. This allow easier access to the oven bottom for cleaning. Be careful not to raise the element more than 4 or 5 inches from the resting position.

Clean using hot, soapy water, a mild abrasive cleanser, a soap-filled abrasive pad or oven cleaner following oven cleaner manufacturer's instructions.

CAUTION **DO NOT** line the oven walls, bottom, racks or any other part of the appliance with aluminum foil. Doing so will destroy heat distribution, produce poor baking results and cause permanent damage to the oven interior (aluminum foil will melt to the interior surface of the oven).

Adhere to the following cleaning precautions:

- Allow the oven to cool before cleaning.
- Wear rubber gloves when cleaning the appliance manually.

Remove spillovers and heavy soils as soon as possible. Regular cleanings now will reduce the extent and difficulty of major cleaning later.

CAUTION Ammonia must be rinsed before operating the oven. Provide adequate ventilation.

General Care & Cleaning (cont'd)

Storage Drawer

Use the storage drawer for storing cooking utensils. The drawer can be removed to facilitate cleaning under the range. Use care when handling the drawer.

Removing and Replacing Storage Drawer

To remove the drawer:

1. Pull empty drawer out to the roller guide stop.
2. Tilt the drawer up and pull it out over the rollers.

To replace the drawer:

1. Insert the rear end of the drawer into the opening.
2. Fit the drawer end rollers onto the guide rails.
3. Push the drawer in until it stops, then lift to allow the rollers to clear the roller guide stop, and push in.

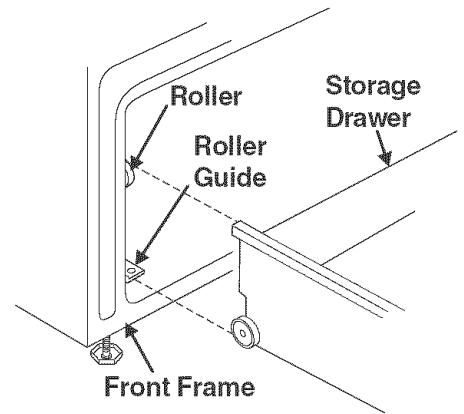

Changing Oven Light

CAUTION Be sure the oven is unplugged and all parts are COOL before replacing the oven light bulb. Do not turn the oven light on during a self-cleaning cycle. High temperature will reduce lamp life.

On some models an interior oven light will turn on automatically when the oven is opened.

The oven light may be turned on when the door is closed by using the oven light switch located on the Electronic Oven control.

The oven light bulb is covered with a glass shield held in place by a wire holder. **THIS GLASS SHIELD MUST ALWAYS BE IN PLACE WHEN THE OVEN IS IN USE.**

To Replace the Light Bulb:

CAUTION BE SURE OVEN IS COOL

1. Turn the power off at the main source.
2. Wear a leather-faced glove for protection against possible broken glass.
3. Replace bulb with a 40 Watt appliance bulb only.
4. Press wire holder to one side to release glass shield, change bulb and be sure to replace glass shield.

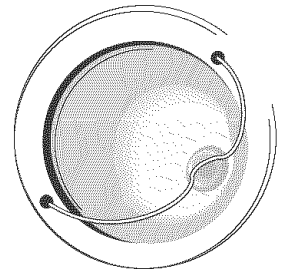

Before you call

Solutions to Common Problems

Before you call for service, review this list. It may save you time and expense. The list includes common occurrences that are not the result of defective workmanship or materials in this appliance.

OCCURRENCE	POSSIBLE CAUSE/SOLUTION
Range is not level.	<p>Poor installation. Place oven rack in center of oven. Place a level on the oven rack. Adjust leveling legs at base of range until the rack is level. When range is level, cooktop may appear out of alignment if countertop is not level.</p> <p>Weak, unstable floor. Be sure floor is level and can adequately support range. Contact a carpenter to correct sagging or sloping floor.</p> <p>Kitchen cabinet misalignment may make range appear to be unlevel. Be sure cabinets are square and have sufficient room for range clearance.</p>
Cannot move appliance easily. Appliance must be accessible for service.	<p>Cabinets not square or are built in too tight. Contact a cabinet maker to correct the problem.</p> <p>Contact builder or installer to make appliance accessible.</p> <p>Carpeting interferes with range. Provide sufficient space so range can be lifted over carpet.</p>
Entire range or oven does not operate.	<p>Make sure cord/plug is tightly into outlet.</p> <p>Service wiring is not complete. Contact your Sears Service Center, installing agent or qualified servicer.</p> <p>Power outage. Check house lights to be sure. Call your local electric company for service.</p>
Surface element does not heat.	<p>No power to the appliance. Check steps under "Entire range or oven does not operate" in this Before You Call checklist.</p> <p>Too low heat setting. Turn control to a slightly higher setting until element comes on.</p> <p>Incorrect control is on. Be sure to use correct control for the element to be used.</p>
Surface element too hot or not hot enough.	<p>Incorrect control setting. Raise or lower setting until proper amount of heat is obtained. Dial markings are an indicator of relative heat settings and will vary slightly.</p> <p>Voltage is incorrect. Be sure appliance is properly connected to the specified power source. If you are not sure about this requirement call 1-800-4-MY-HOME® for service (See back cover).</p> <p>Lightweight or warped pans were used. Be sure to use proper cookware. Use only flat bottom, evenly balanced medium or heavyweight cookware. Heavy and medium weight pans heat evenly. Because lightweight pans heat unevenly, foods may burn easily.</p>
Food not heating evenly.	<p>Lightweight or warped pans were used. Be sure to use proper cookware. Use only flat bottom, evenly balanced medium or heavyweight cookware. Heavy and medium weight pans heat evenly. Because lightweight pans heat unevenly, foods may burn easily.</p> <p>Incorrect control setting. Raise or lower setting until proper amount of heat is obtained.</p>
Drip bowls are pitting or rusting.	<p>Foods with acids, such as tomatoes, if allowed to stand in/on bowls will cause corrosion. Remove and wash drip bowls as soon as possible after a spillover.</p> <p>Normal environment. Houses along sea coast are exposed to salt air. Protect bowls as much as possible from direct exposure to salt air.</p>

Before you call

Solutions to Common Problems

Drip bowls turning color or distorted out of shape.	Bottom surface of cookware extends beyond surface elements and touches cooktop surface. This can cause high enough temperatures to discolor the drip bowls. DO NOT use cookware of this type. Pan sizes should be matched to the size of the element. Replacement drip bowls may be purchased from Sears Parts & Repair. <hr/> Surface elements not seated properly in terminal. Turn control to OFF. Be sure surface element is COOL. Lift out surface element. Position element properly, following instructions under General Care & Cleaning .
Oven control beeps and displays F1, F3 or F9	Electronic control has detected a fault condition. Press CLEAR to clear the display and stop beeping. Program oven again. If fault recurs, record fault number. Press CLEAR and contact Sears or other qualified agency.
Oven light does not work.	Replace or tighten bulb. See “ Changing Oven Light ” in this Use & Care Guide for instructions.
Poor baking results.	Many factors affect baking results. Make sure the proper rack position is used. Center food in the oven and space pans to allow air to circulate. Allow the oven to preheat to the set temperature before placing food in the oven. Try adjusting the recipes’ recommended temperature or baking time.
Oven smokes excessively during broiling.	Control(s) not set properly. Follow instructions under “ Setting Oven Controls ” in this Use and Care Guide. <hr/> Make sure oven is opened to Broil Stop Position . <hr/> Meat too close to the element. Reposition the rack to provide proper clearance between the meat and the element. Preheat broil element. <hr/> The insert on broiler pan wrong side up and grease not draining. Always place insert on the broiler pan with ribs up and slots down to allow grease to drip into pan. <hr/> Grease has built up on oven surfaces. Regular cleaning is necessary when broiling frequently. Old grease or food spatters cause excessive smoking.

Notes

ENGLISH

Get it fixed, at your home or ours!

Your Home

For repair – **in your home** – of all major brand appliances, lawn and garden equipment, or heating and cooling systems, **no matter who made it, no matter who sold it!**

For the replacement parts, accessories and owner's manuals that you need to do-it-yourself.

For Sears professional installation of home appliances and items like garage door openers and water heaters.

1-800-4-MY-HOME[®] (1-800-469-4663)

Call anytime, day or night (U.S.A. and Canada)

www.sears.com www.sears.ca

Our Home

For repair of carry-in items like vacuums, lawn equipment, and electronics, call or go on-line for the location of your nearest

Sears Parts & Repair Center.

1-800-488-1222

Call anytime, day or night (U.S.A. only)

www.sears.com

To purchase a protection agreement (U.S.A.) or maintenance agreement (Canada) on a product serviced by Sears:

1-800-827-6655 (U.S.A.)

1-800-361-6665 (Canada)

Para pedir servicio de reparación a domicilio, y para ordenar piezas:

1-888-SU-HOGAR[®]

(1-888-784-6427)

Au Canada pour service en français:

1-800-LE-FOYER^{MC}

(1-800-533-6937)

www.sears.ca



Free Manuals Download Website

<http://myh66.com>

<http://usermanuals.us>

<http://www.somanuals.com>

<http://www.4manuals.cc>

<http://www.manual-lib.com>

<http://www.404manual.com>

<http://www.luxmanual.com>

<http://aubethermostatmanual.com>

Golf course search by state

<http://golfingnear.com>

Email search by domain

<http://emailbydomain.com>

Auto manuals search

<http://auto.somanuals.com>

TV manuals search

<http://tv.somanuals.com>