

SEARS

MM# - 3638597782

Kenmore Refrigerator Owner's Manual

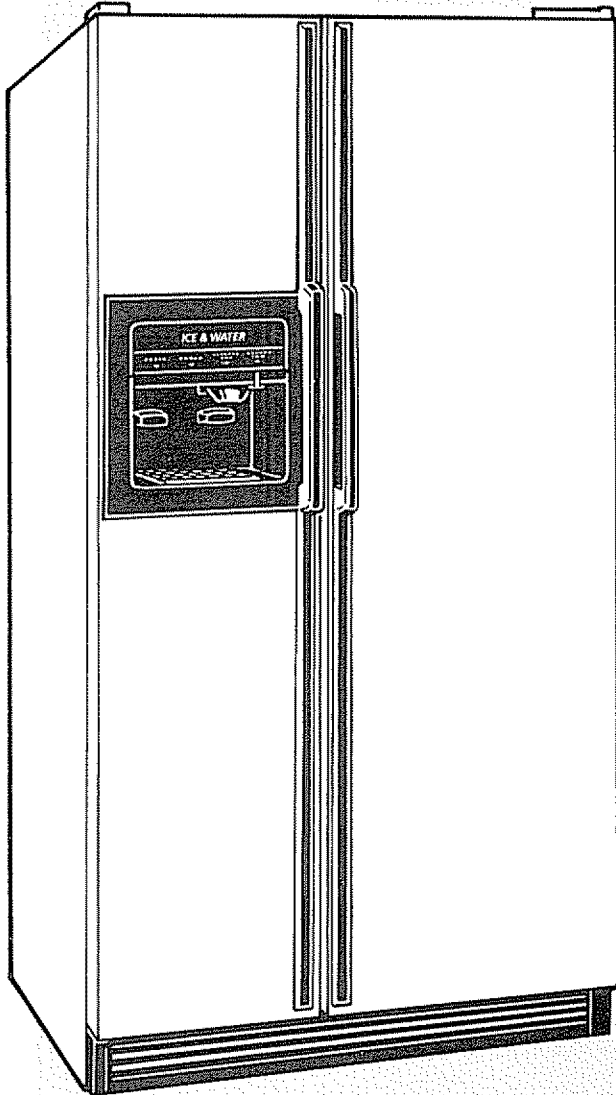

Contents

- Safety Instructions 2
- Grounding Requirements 2, 3
- Starting the Refrigerator 3
- Adjusting the Controls 4
- Energy-Saving Tips 4
- Food Storage Suggestions 5-7
- Features 8, 9
- Ice & Chilled Water Dispenser 10, 11
- Care and Cleaning 12, 13
- Before You Call for Service 14, 15
- Vacation and Moving Precautions 15
- Warranty Back Cover

Please record the model number, serial number and date you purchased your Kenmore refrigerator in the spaces below. See pages 8 and 9 for model and serial number location.

Model Number

Serial Number

Date of Purchase

SEARS, ROEBUCK AND CO., Chicago, IL 60684 U.S.A.

59771
59778

IMPORTANT SAFETY INSTRUCTIONS

Read all instructions before using this appliance.

WARNING— When using this appliance, always exercise basic safety precautions, including the following:

- **Use this appliance only for its intended purpose** as described in this Owner's Manual.
- **This refrigerator must be properly installed in accordance with the Attention Installer Instructions before it is used.** See grounding requirements below and on page 3.
- **Never unplug your refrigerator by pulling on the power cord.** Always grip plug firmly and pull straight out from the outlet.
- **Repair or replace immediately all electric service cords that have become frayed or otherwise damaged.** Do not use a cord that shows cracks or abrasion damage along its length or at either the plug or connector end.
- **When moving your refrigerator away from the wall, be careful not to roll over or damage the power cord.**
- **After your refrigerator is in operation, do not touch the cold surfaces, particularly when hands are damp or wet.** Skin may adhere to the extremely cold surfaces.
- **Do not place fingers or hands on the automatic icemaking mechanism while the refrigerator is plugged in.** This will help protect you from possible injury. It will also prevent interference with the moving parts of the ejector mechanism, or with the heating element that releases the cubes.
- **Do not operate your refrigerator in the presence of explosive fumes.**

◦ **Don't refreeze frozen foods which have thawed completely.** The United States Department of Agriculture in Home and Garden Bulletin No. 69 says:

"...You may safely refreeze frozen foods that have thawed if they still contain ice crystals or if they are still cold—below 40°F.

"...Thawed ground meats, poultry or fish that have any off-odor or off-color should not be refrozen and should not be eaten. Thawed ice cream should be discarded. If the odor or color of any food is poor or questionable, get rid of it. The food may be dangerous to eat.

"Even partial thawing and refreezing reduce the eating quality of foods, particularly fruits, vegetables and prepared foods. The eating quality of red meats is affected less than that of many other foods. Use refrozen foods as soon as possible to save as much of their eating quality as you can."

◦ **If your old refrigerator is still around the house but not in use, be sure to remove the doors.** This will reduce the possibility of danger to children.

◦ Unplug your refrigerator:

A. Before making any repairs. Note: We strongly recommend that any servicing be performed by a qualified individual.

B. Before cleaning.

C. Before replacing a burned-out light bulb, the refrigerator should be unplugged in order to avoid contact with a live wire filament. (A burned-out light bulb may break when being replaced.)

Note: Turning control to OFF position does not remove power to the light circuit.

SAVE THESE INSTRUCTIONS

Grounding Requirements Important—Please read carefully.

To connect electricity

For personal safety, this appliance must be properly grounded.

The power cord of this appliance is equipped with a three-prong (grounding) plug which mates with a standard three-prong (grounding) wall outlet (Fig. 1) to minimize the possibility of electric shock hazard from this appliance.

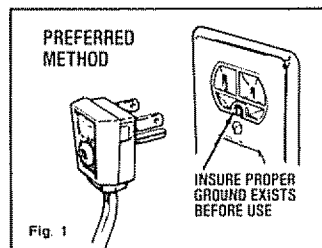

Have wall outlet and circuit checked by a qualified electrician to make sure outlet is properly grounded.

Where a standard two-prong wall outlet is encountered, it is your personal responsibility and obligation to have it replaced with a properly grounded three-prong wall outlet.

DO NOT, UNDER ANY CIRCUMSTANCES, CUT OR REMOVE THE THIRD (GROUND) PRONG FROM THE POWER CORD.

Starting the Refrigerator

Use of adapter plug

Because of potential safety hazards under certain conditions, we strongly recommend against use of an adapter plug. However, if you still elect to use an adapter, where local codes permit, a TEMPORARY CONNECTION may be made to a properly grounded two-prong wall outlet by use of a UL listed adapter (Fig. 2) available at most local hardware stores.

The larger slot in the adapter must be aligned with the larger slot in the wall outlet to provide proper polarity in the connection of the power cord.

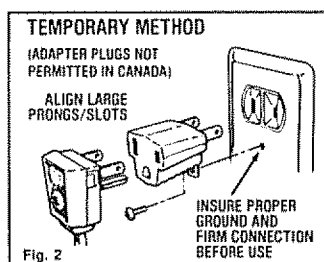

CAUTION: Attaching an adapter ground terminal to the wall outlet cover screw does not ground the appliance unless the cover screw is metal, and not insulated, and the wall outlet is grounded through the house wiring. You should have circuit checked by a qualified electrician to make sure the outlet is properly grounded.

When disconnecting the power cord from the adapter, always hold the adapter with one hand. If this is not done, the adapter ground terminal is very likely to break with repeated use.

Should the adapter ground terminal break, DO NOT USE the appliance until a proper ground has again been established.

Use of Extension Cords

Because of potential safety hazards under certain conditions, we strongly recommend against the use of an extension cord. However, if you still elect to use an extension cord, it is absolutely necessary that it be a UL listed 3-wire grounding type appliance extension cord having a grounding type plug and outlet and that the electrical rating of the cord be 15 amperes (minimum) and 120 volts.

Electrical Requirements

The refrigerator should always be plugged into its own individual electrical outlet—115 volt, 60 Hertz, single phase AC. This is recommended for best performance and to prevent overloading house wiring circuits, which could cause a fire hazard from overheating wires.

Location

- Install the refrigerator on a floor strong enough to support it when it is fully loaded.
- Do not install it where the temperature will go below 60°F. because it will not run often enough to maintain proper temperatures.
- Do not install it next to your range, a heating vent or where the sun will shine directly on it.

Clearances

Allow the following clearances for ease of installation, proper air circulation, and plumbing and electrical connections:

Sides ... 5/8" Top 0" Back 1"
(If built-in, allow 7/8" at top for hinge covers.)

Allow a 1½" door clearance at refrigerator side, 1¾" at freezer side.

Leveling

Adjustable rollers behind the base grille enable you to move the refrigerator away from the wall for cleaning. These rollers should be set so the refrigerator rests firmly on the floor with the front raised just enough that the doors close easily when opened about halfway. Specially designed door hinges lift both doors slightly when opened; the force of gravity helps close them automatically.

To adjust the rollers:

- Remove the base grille. Grasp it at the bottom and pull it out.
- Turn the roller adjusting screws **clockwise to raise** the refrigerator, **counter-clockwise to lower** it. Use an adjustable wrench or pliers on the 3/8" bolts. Both doors should close properly when bottom front edge of refrigerator cabinet is about 5/8" from the floor.
- **To replace the base grille,** line up the prongs on the grille with the clamps on the refrigerator and push forward until the grille snaps into place.

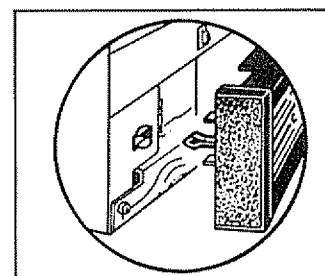
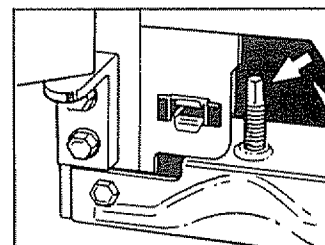
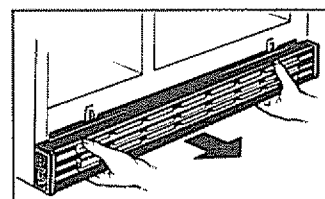

Adjusting the Controls



Two controls let you regulate the temperature in the fresh food and freezer compartments.

At first, set the fresh food control at "4" and the freezer control at "C."

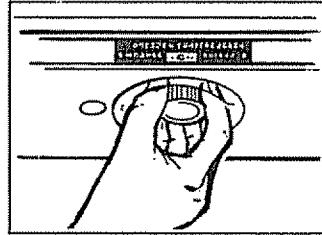

Allow 24 hours for the temperature to stabilize, whether you are setting the controls for the first time or adjusting them later. Then, if you want colder or warmer temperatures in either compartment, adjust the controls one letter or number at a time.

Note: Turning the fresh food control to OFF turns off cooling in both compartments—fresh food and freezer—but does not shut off power to the refrigerator.

How to Test Temperatures

Use the milk test for the fresh food compartment. Place a container of milk on the top shelf in the fresh food compartment. Check it a day later. If the milk is too warm or too cold, adjust the temperature controls.

Use the ice cream test for the freezer compartment. Place a container of ice cream in the center of the freezer compartment. Check it after a day. If it's too hard or too soft, adjust the temperature controls.

Turning Your Household Thermostat Below 60°F. at Night?

You may want to turn the lettered control one step colder, as from "C" to "D." Cooler temperatures in the house may cause the compressor to operate less frequently, thus allowing the freezer compartment to warm somewhat.

To protect your frozen food supply, leave your lettered control at this new, colder setting for the entire winter or for as long as you keep your thermostat turned down.

Turning the lettered control to a colder setting should have no effect on your fresh food compartment. However, if freezing occurs, turn the numbered control one step warmer, as from "4" to "3."

When you stop turning the household thermostat down at night, turn the refrigerator temperature controls back to their regular settings.

Energy-Saving Tips

- Don't open the doors more often than necessary.
- Close the doors as soon as possible, particularly in hot, humid weather.
- Be sure the doors are closed tightly. Before leaving the house or retiring for the night, check to be sure the doors haven't been left open accidentally.
- Store only those foods requiring refrigeration in your refrigerator.
- Wipe moisture from bottles and cartons before putting them in the refrigerator.
- Keep foods covered to reduce moisture buildup inside the refrigerator.
- If you turn the controls to the coldest position for quick chilling or freezing, be sure to turn them back to regular settings.
- Don't overcrowd your refrigerator. Overcrowding can require extra electrical energy to keep everything cool.

Food Storage Suggestions

Suggested Storage Times

| <u>Eating quality drops after time shown</u> | DAYS IN REFRIGERATOR AT 35° to 40°F. | MONTHS IN FREEZER AT 0°F. |
|--|--|---------------------------------------|
| | Fresh Meats | |
| Roasts (Beef & Lamb) | 3 to 5 | 6 to 12 |
| Roasts (Pork & Veal) | 3 to 5 | 4 to 8 |
| Steaks (Beef) | 3 to 5 | 6 to 12 |
| Chops (Lamb) | 3 to 5 | 6 to 9 |
| Chops (Pork) | 3 to 5 | 3 to 4 |
| Ground & Stew Meats | 1 to 2 | 3 to 4 |
| Variety Meats | 1 to 2 | 3 to 4 |
| Sausage (Pork) | 1 to 2 | 1 to 2 |
| Processed Meats | | |
| Bacon | 7 | 1 |
| Frankfurters | 7 | ½ |
| Ham (Whole) | 7 | 1 to 2 |
| Ham (Half) | 3 to 5 | 1 to 2 |
| Ham (Slices) | 3 | 1 to 2 |
| Luncheon Meats | 3 to 5 | Freezing not recom- mended. |
| Sausage (Smoked) | 7 | |
| Sausage (Dry & Semi-Dry) | 14 to 21 | |
| Cooked Meats | | |
| Cooked Meats and Meat Dishes | 3 to 4 | 2 to 3 |
| Gravy & Meat Broth | 1 to 2 | 2 to 3 |
| Fresh Poultry | | |
| Chicken & Turkey (Whole) | 1 to 2 | 12 |
| Chicken (Pieces) | 1 to 2 | 9 |
| Turkey (Pieces) | 1 to 2 | 6 |
| Duck & Goose (Whole) | 1 to 2 | 6 |
| Giblets | 1 to 2 | 3 |
| Cooked Poultry | | |
| Pieces (Covered with Broth) | 1 to 2 | 6 |
| Pieces (Not Covered) | 3 to 4 | 1 |
| Cooked Poultry Dishes | 3 to 4 | 4 to 6 |
| Fried Chicken | 3 to 4 | 4 |
| (Other than for meats & poultry) FREEZER | | |
| Most fruits and vegetables | | 8-12 months |
| Lean fish | | 6-8 months |
| Fatty fish, rolls and breads, soups, stew, casseroles | | 2-3 months |
| Cakes, pies, sandwiches, leftovers (cooked), Ice cream (original carton) | | 1 month max. |

Meats, fish and poultry purchased from the store vary in quality and age; consequently, safe storage times in your refrigerator will vary.

New techniques are constantly being developed. Consult the College or County Extension Service or your local Utility Company for the latest information on freezing and storing foods.

Fresh Food Storage Tips

To store unfrozen meats, fish and poultry:

- Always remove store wrappings.
- Rewrap in foil, film or wax paper and refrigerate immediately.

To store cheese, wrap well with wax paper or aluminum foil, or put in a plastic bag.

- Carefully wrap to expel air and help prevent mold.
- Store pre-packaged cheese in its own wrapping if you wish.

To store vegetables, use the vegetable drawers—they've been designed to preserve the natural moisture and freshness of produce.

- Covering vegetables with a moist towel helps maintain crispness.

- As a further aid to freshness, pre-packaged vegetables can be stored in their original wrapping.

To store ice cream—Fine-quality ice cream, with high cream content, will normally require slightly lower temperatures than more "airy" already-packaged brands with low cream content.

- It will be necessary to experiment to determine the freezer compartment location and temperature control setting to keep your ice cream at the right serving temperature.

- The rear of the freezer compartment is slightly colder than the front.

Tips on freezing foods

There are three essential requirements for efficient home freezing.

1. Initial quality. Freeze only top-quality foods. Freezing retains quality and flavor; it cannot improve quality.

2. Speed. The quicker fruits and vegetables are frozen after picking, the better the frozen product will be. You'll save time, too, with less culling and sorting to do.

3. Proper packaging. Use food wraps designed especially for freezing; they're readily available at most food stores.

(continued next page)

Food Storage Suggestions

Tips on Freezing Foods

(continued)

To freeze meat, fish and poultry, wrap well in freezer-weight foil (or other heavy-duty wrapping material) forming it carefully to the shape of the contents. This expels air. Fold and crimp ends of the package to provide a good, lasting seal.

Don't refreeze meat that has completely thawed; meat, whether raw or cooked, can be frozen successfully only once.

Limit freezing of fresh (unfrozen) meats or seafoods to 29 pounds at a time.

For Convenience . . .

- Store like things together. This saves both time and electricity because you can find foods faster.
- Place the oldest items up front so they can be used up promptly.
- Use bins on the door for most often used sauces and condiments.
- Use the meat drawer for meats you do not freeze.

To Save Money in Energy and Food Costs

- Place most perishable items, such as milk, cream or cottage cheese, toward the rear of the top shelf. They will stay coldest in this part of the fresh food compartment.
- Cover moist foods with tight lids, plastic film or foil.
- Leaf vegetables and fruits placed in drawers will last longer when stored in closed plastic containers or wrapped in plastic film.
- Do not overload your fresh food or freezer compartment with a lot of warm food at one time.
- Open the door the fewest times possible to save electrical energy.
- When going out of town for several days, leave as few perishables as possible in the refrigerator. Move the icemaker feeler arm to the OFF (up) position and shut off water to the refrigerator.

Shelves

Removable Door Bins in the Fresh Food Compartment

To remove bins: Lift bin straight up until mounting hooks disengage.

To relocate bins: Select desired bin height, engage hooks in slots on the tracks of the door, and push in. Bin will lock in place.

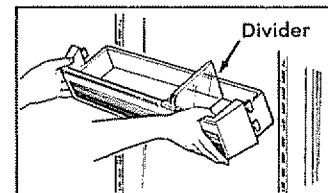

Dividers

Dividers are designed to give you storage flexibility in door bins on your fresh food door. Items such as salad dressings, steak sauces and other condiments can now be kept securely against the door liner to help prevent tipping, spilling or sliding.

Place index finger and middle finger on either side of the divider near the front and simply move it back and forth to fit your needs.

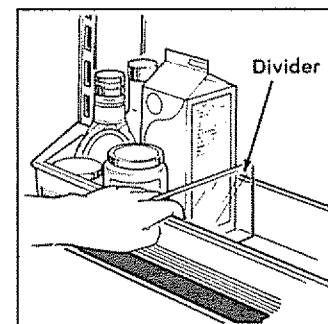

Adjustable Shelves in the Fresh Food Compartment

Adjustable shelves in the fresh food compartment enable you to make efficient shelf arrangements to fit your family's food storage needs.

• **To remove shelves,** tilt the shelf up at front, then lift it up and out of the tracks on the rear wall of the refrigerator.

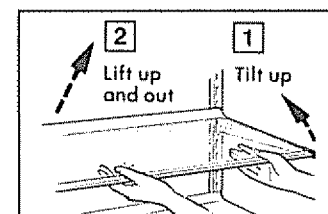

To replace shelves, select desired shelf height. With the shelf front raised slightly, engage the top lugs in the tracks at the rear of the cabinet. Then lower the front of the shelf until it locks into position.

Storage Drawers

Handi Dishes

Cooking-serving-storage dishes with durable see-through lids fit into a slide-out tray that, together with the shelf to which it attaches, can be located anywhere in the fresh food compartment.

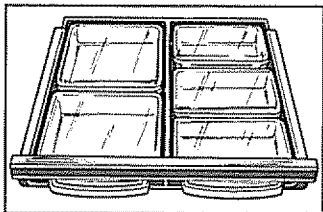

Dishes and lids are safe for use in microwave ovens, refrigerators, freezers, and are dishwasher-safe. Dishes only are safe in conventional ovens at temperatures up to 400°F.

Caution: Lids cannot withstand the heat generated in conventional ovens. Dishes and lids are not designed for range-top cooking or broiler use. Such use can be hazardous.

Deep Door Shelves in the Freezer Compartment

Detachable shelf extenders deepen and enclose three fixed door shelves, providing more storage room and greater storage flexibility.

To remove, lift shelf extender straight up until mounting hooks come out of slots in door.

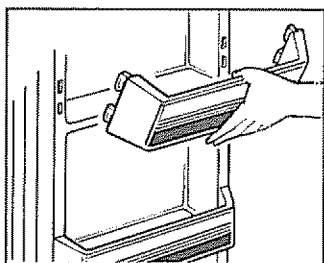

To replace, line up hooks with slots in door, then push in and down.

Removable Freezer Basket Shelves

Shelves in the freezer compartment will stop before coming all the way out of the freezer to help prevent contents from spilling onto the floor. They can be removed easily by lifting up slightly and pulling past the "stop" location.

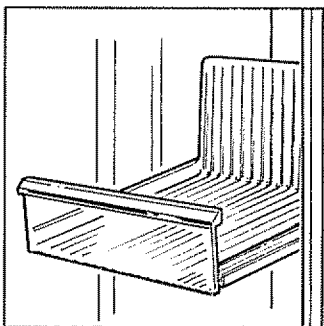

Removable Wine Rack

The wine rack is designed to hold a bottle on its side and will fit on any shelf. To relocate it, pull it straight out, position its lip over either edge of the shelf you want to suspend it from, and push it all the way in.

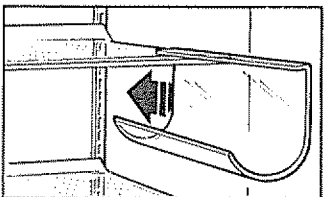

Nice 'N Fresh Drawer

This drawer has been specially designed to help preserve fruits and vegetables.

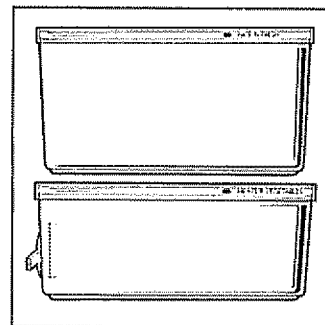

Meats 'R Vegetables Drawer

The convertible meat drawer has its own cold air duct to allow a stream of cold air from the freezer compartment to flow around the drawer.

The variable temperature control regulates the air flow from the freezer compartment.

Set the control lever all the way down—the coldest setting—to store fresh meats. If the lever is left in the meat position for a long period of time, some frost may form on the inside of the drawer.

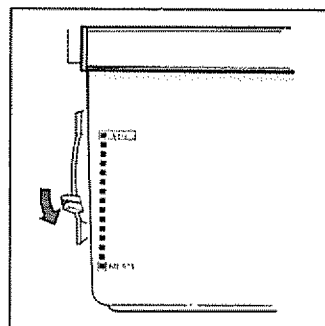

Set the control lever all the way up to convert the Meats 'R Vegetables drawer to normal refrigerator temperature and provide extra vegetable storage space. The cold air duct is turned off.

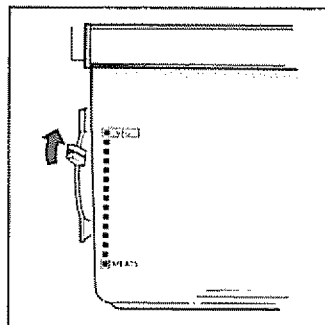

Variable settings between these extremes can be selected.

Features

TEMPERATURE CONTROLS

Set Freezer control at "C," Fresh Food control at "4."
They may need adjusting later. See page 4.

ICE ACCESS DOOR

Lift it to turn icemaker on or off, or to level ice cubes
in storage bin from time to time.

ICE STORAGE COMPARTMENT

Ice is made and stored here until called for by
pressed cradle in dispenser on front of door.

WATER AND ICE DISPENSER

Located on outside of freezer compartment door, it
dispenses ice cubes, crushed ice and chilled water
through the door.

REMOVABLE FREEZER BASKET SHELVES

Pull a basket shelf forward to the "stop" position and
food at the back of the shelf becomes easier to
reach. Lift the shelf up slightly and you can pull it all
the way out and take it to the food preparation area
to remove things from it or add things to it.

FREEZER DOOR SHELVES

Door shelves keep frequently-used frozen food items
within easy reach. Detachable shelf-extendors
deepen and enclose them.

FREEZER BIN

This slide-out bin holds bulky and odd-shaped food
packages and makes them easily accessible without
disturbing frozen food next to or on top of them.

TEXTURED STEEL DOORS

Touch the textured doors; they won't show
fingerprints.

MAGNETIC DOOR GASKETS

Doors close quietly, and gaskets seal tightly when
the refrigerator is level—see page 3.

NO DEFROSTING

It is not necessary to defrost the freezer or fresh food
compartments. Your refrigerator is designed and
equipped to defrost itself automatically.

AUTOMATIC ENERGY SAVER SYSTEM

Warm liquid from the refrigerator's condenser is
automatically circulated around the front edge of the
freezer compartment to help keep moisture from
forming on the outside of the refrigerator during
humid weather.

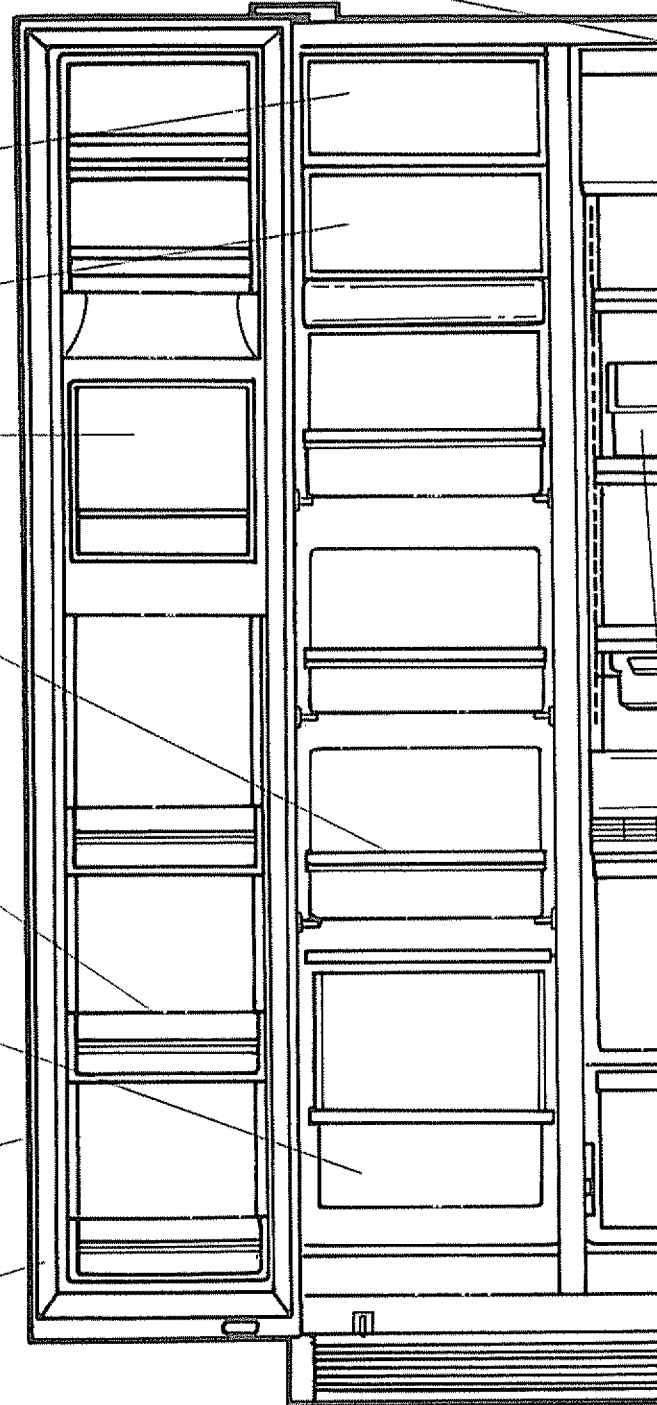

MODEL AND SERIAL NUMBER LOCATION

You'll find these numbers here. To order repair parts,
see the parts list that came with your refrigerator, or
take these numbers to your nearest Sears Service
Center and they will help you.

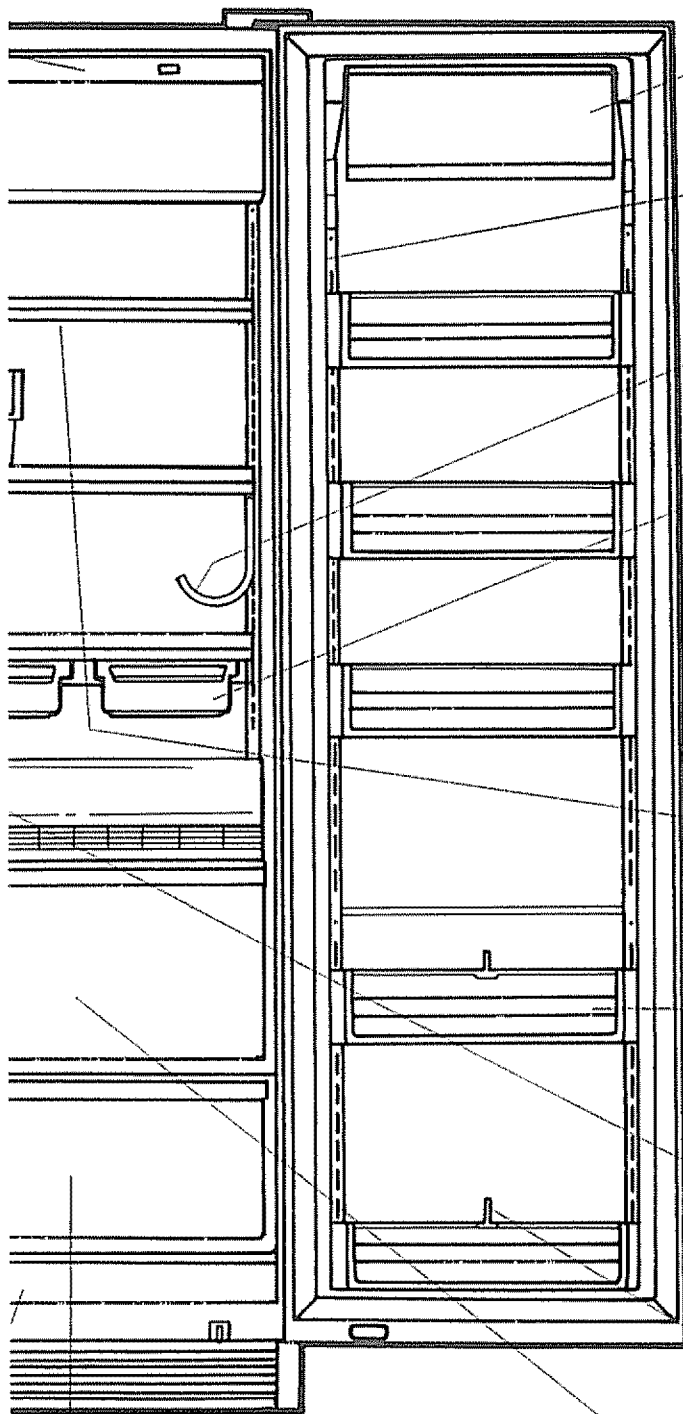

HANDI-BIN

Door stays open while bin is in use, provides easy access to dairy products.

USE AND CARE LABEL

Information you'll want to know is right on the refrigerator, including everyday care.

WINE RACK

Holds a bottle on its side, will fit on any shelf. See page 6.

HANDI DISHES

Cooking-serving-storage dishes with see-through lids fit into a slide-out tray that, together with the shelf to which it attaches, can be located anywhere in the fresh food compartment. Dishes are safe for use in microwave ovens, refrigerators, freezers, and are dishwasher-safe. Dishes only are safe in conventional ovens at temperatures up to 400°F., lids are not. Neither dishes or lids are for range-top cooking or broiler use. Such use can be hazardous.

ADJUSTABLE TEMPERED GLASS SHELVES

These shelves let you arrange—and rearrange—the interior of your refrigerator to meet your ever-changing food storage needs.

DOOR BINS

Portable, lightweight bins adjust easily to accommodate items of various heights, can be used to carry contents directly to countertop or table for preparation or serving.

UTILITY BIN

Dual-usage bin holds two dozen eggs in their cartons, or stores an extra supply of ice cubes in the freezer for special occasions.

DIVIDERS

Move them where needed on door bins to keep items such as small bottles and jars so they won't tip, spill or slide.

MEATS 'R VEGETABLES DRAWER WITH ADJUSTABLE COLD CONTROL

The variable temperature control next to the Meats 'R Vegetables drawer regulates the flow of cold air from the freezer. Set the control lever all the way down to the coldest setting to store meats. Set it all the way up to convert the drawer to normal refrigerator temperature and provide extra vegetable storage space.

NICE 'N FRESH DRAWER

This roomy drawer has been specially designed to help preserve the natural goodness of fruits and vegetables.

Automatic Icemaker and Ice & Chilled Water Dispenser

See separate *Water Line Installation Requirements* included in both the literature pack and on the back of the refrigerator.

An automatic icemaker and a dispenser provide chilled water, ice cubes and crushed ice through the freezer compartment door.

Here's how they work:

Water flows from household water supply through

(1) dual solenoid valve to
(2) water reservoir and to
(3) automatic icemaker as needed.

Water is frozen in

(4) cube mold and ejected into
(5) storage bin where a motor-powered auger moves cubes forward into dispensing unit. Cubed or crushed ice, as selected, dispense through chute in door when cradle is pressed.

When switch is moved to CRUSHED, baffle in housing channels cubes through crusher and crushed ice falls through chute into glass.

Chilled water from reservoir flows through
(6) tubing in door and is dispensed when cradle is pressed.

Pressure on cradle turns light in dispenser on, releasing pressure turns the light off.

(7) **A light switch** also turns night light in dispenser on and off.

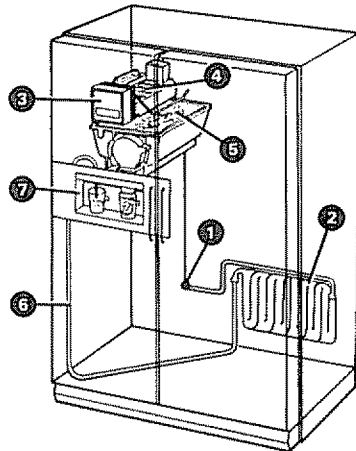

Important Facts about Your Dispenser

- **Your icemaker will produce eight cubes per cycle**—approximately 120 cubes in a 24-hour period—depending on freezer compartment temperature, room temperature, number of door openings and other use conditions.

- **Intermittent dispensing of ice is normal.** If ice flow interruption is more than brief, ice clump(s) may be the cause and should be removed following instructions on page 11.

- **Avoid overfilling glasses with ice and using narrow or extra-tall glasses.** This can jam the chute or cause the door in the chute to freeze shut. Periodically open the freezer compartment door and look down into the chute. If ice is blocking the chute, poke it through with a wooden spoon.

- **To help keep bits of ice from being sprayed beyond the glass**, place glass close to ice chute—but not so close that it blocks outcoming ice.

- **Do not dispense ice into thin glasses, fine china or delicate crystal**—they can crack or chip from combined pressure of hand pressing them against cradle and ice dropping into container.

- **Dispense ice before filling glass with soda or other beverage mixes.** This will prevent splashing which is annoying and which, if the splash reaches the ice selector switch, could cause it to stick or bind.

- **Beverages and foods should not be quick-chilled in the ice storage bin.** Cans, bottles or food packages in the storage bin may cause the icemaker to malfunction.

- **Ice other than that produced by your icemaker should not be added to the ice storage bin**—it may not crush or dispense well.

Before Using Your Icemaker and Dispenser

If refrigerator is operated before water connection is made, raise ice access door and make sure icemaker feeler arm is in OFF (up) position.

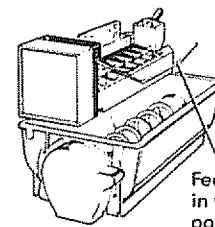
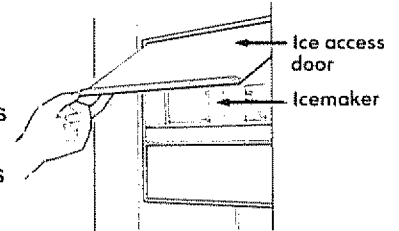

Feeler Arm in OFF position

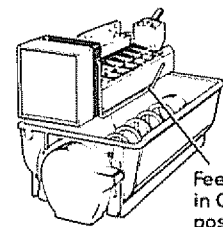

Feeler Arm in ON position

When water supply has been connected to icemaker, move feeler arm to ON (down) position.

Depress water dispenser cradle for about two minutes to remove trapped air from the water line and to fill water reservoir automatically.

The ice cube mold will automatically fill with water after cooling to freezing temperature, and first cubes normally freeze after several hours.

When cubes are solidly frozen, they will be ejected from the mold into the ice storage bin by means of a sweeper arm. Icemaking will continue until the feeler arm senses that there are enough cubes in the bin and halts the operation temporarily. Be sure nothing interferes with the swing of the feeler arm.

For maximum ice storage, level the stored cubes with your hand occasionally.

Once your icemaker is in operation, throw away the first few batches of ice cubes. This will flush away any impurities in the water line. Do the same thing after vacations or long periods when ice isn't used.

Discard the first six glassfuls of water in the kitchen sink. This will eliminate the slight "plastic" taste temporarily imparted to the water by the water reservoir.

CAUTION: Under certain rare circumstances, ice cubes may be discolored, usually appearing with a green-bluish hue. This unusual discoloration is apparently due to a combination of factors such as certain characteristics of local waters, household plumbing and the accumulation of copper salts in an inactive water supply line which feeds the icemaker. Continued consumption of such discolored ice cubes may be injurious to health. If your ice cubes are discolored, discard them and contact your Sears Service Center.

To Dispense Ice and Water

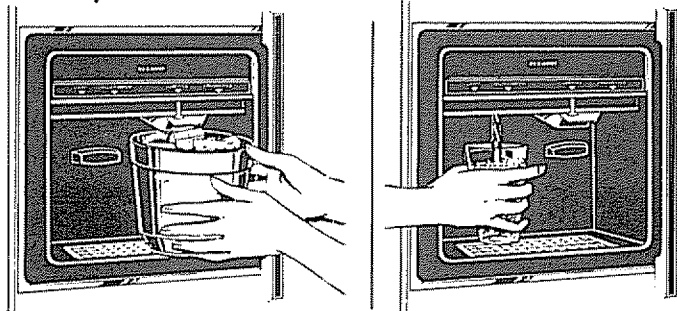

For ice, set selector switch to CUBED or CRUSHED.

For water, simply position container beneath words "CHILLED WATER."

Grip container gently near the rim and press rim firmly against ice or water dispenser cradle.

CAUTION: Never put fingers or other objects into the ice crusher discharge opening.

When dispensing ice, some crushed ice may be dispensed even though you selected CUBED. This happens occasionally when a few cubes accidentally get channeled to the crusher.

Sometimes a mound of snow will form on the door in the ice chute. This condition is normal, and usually occurs when you have dispensed crushed ice repeatedly. The snow will eventually evaporate.

The water system provides approximately six successive 6-ounce glassfuls, after which it takes several hours for replenished water reservoir supply to cool. You probably will not drain all the chilled water from the reservoir on a single occasion.

The first glass of water dispensed may be warmer than the following ones. This is normal.

Dispensed water is chilled, not iced. For colder water, simply add ice before dispensing water.

To stop dispensing, release pressure from cradle and withdraw slowly to catch last bits of ice or drops of water.

Some slight dripping may occur following dispensing of crushed ice or chilled water. If excessive, wipe the spill dry immediately.

Do not pour water in spill shelf because it is not self-draining—pour it in the kitchen sink. Clean the spill shelf and its grille regularly—see page 12.

If Ice Clumps Form in Storage Bin...

If ice is not used often, ice clumps can form in the storage bin, resulting in temporary malfunction of the dispenser mechanism. If this happens, remove storage bin from freezer compartment, break up ice clumps with fingertip pressure and discard remaining clumps.

Replace bin before remaining cubes melt and fuse together.

To remove ice cube storage bin, lift the left corner to free the bin from the shelf, and pull the bin straight out while supporting it at front and back.

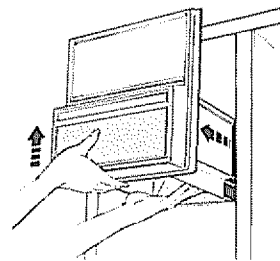

To replace bin, slide the bin back until the tab on the bin locks into the slot in the shelf.

If bin does not go all the way back, remove it and rotate the drive mechanism 1/4 turn. Then push bin back again until the tab on the bin locks into the slot in the shelf.

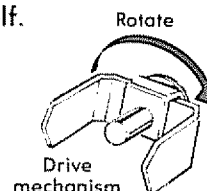

If ice is not used often, old cubes will become cloudy and taste stale. Empty the ice storage bin periodically and wash it in lukewarm water.

Move feeler arm to OFF (up) position when:

- the home water supply is to be off for several hours.
- the ice storage bin is to be removed for a period of time.
- going away on vacation. (Also turn off the valve in the water supply line to the refrigerator.)

If this is your first icemaker, you will hear occasional sounds that may be unfamiliar. They are normal ice-making sounds and are not cause for concern.

A water filter accessory kit to help purify off-tasting incoming water and a water supply accessory kit to help connect the icemaker to the cold water line are optional at extra cost—see page 15.

Care and Cleaning

Outside

The water and ice dispenser spill shelf should be wiped dry immediately to prevent spotting. Water left on the shelf may leave deposits that you can remove by soaking in undiluted vinegar. You can also use a paste of non-precipitating water softener (such as Calgon brand) and water, or one teaspoon of citric acid powder per pint of hot tap water. Soak until the deposit disappears or becomes loose enough to rinse away. Usually 30 minutes soaking time is adequate. Avoid using wax on the spill shelf and trim.

The door handles and trim can be cleaned with a cloth dampened with a solution of mild liquid dishwashing detergent and water. Dry with a soft cloth. Don't use wax on the door handles and trim.

Keep the finish clean. Wipe with a clean cloth lightly dampened with kitchen appliance wax or mild liquid dishwashing detergent. Dry and polish with a clean, soft cloth. Do not wipe the refrigerator with a soiled dishwashing cloth or wet towel. These may leave a residue that can harm the paint. Do not use scouring pads, powdered cleaners, bleach or cleaners containing bleach because these products can scratch and weaken the paint finish.

Protect the paint finish. The finish on the outside of the refrigerator is a high quality, baked-on paint finish. With proper care, it will stay new-looking and rust-free for years. Apply a coat of kitchen/appliance wax when the refrigerator is new and then at least twice a year.

Inside

The inside of the fresh food and freezer compartments should be cleaned at least once a year. Unplug the refrigerator before cleaning. If this is not practical, wring excess moisture out of sponge or cloth when cleaning around switches, lights or controls.

Use warm water and baking soda solution—about a tablespoon of baking soda to a quart of water. This both cleans and neutralizes odors. Rinse thoroughly with water and wipe dry.

Other parts of the refrigerator—including door gaskets, meat and vegetable drawers, ice storage bin and all plastic parts—can be cleaned the same way. Do not use cleansing powders or other abrasive cleaners.

To help prevent odors, leave an open box of baking soda in the rear of the refrigerator, on the top shelf. Change the box every three months. An open box of baking soda in the freezer will absorb stale freezer odors.

Do not wash any plastic parts from your refrigerator in your automatic dishwasher.

Storage Drawers

Drawers at bottom of fresh food compartment will stop before coming all the way out of refrigerator to help prevent contents from spilling onto floor. The drawers can be removed easily by tilting up slightly and pulling past the "stop" location.

To remove storage drawers when fresh food compartment door cannot be opened fully:

1. Remove food from shelf above top drawer and take out shelf.

2. Take food off glass cover and out of drawer.

3. Grasp top of light panel above the top drawer, flex and rotate upper surface of panel until it clears the upper pin on each side wall. Then, keeping panel upright, pull bottom of panel toward you until it clears the lower side-wall pins.

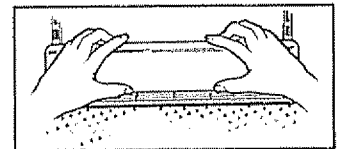

4. Put your fingers behind the gasket at the rear of the drawer and pull forward. Remove the gasket.

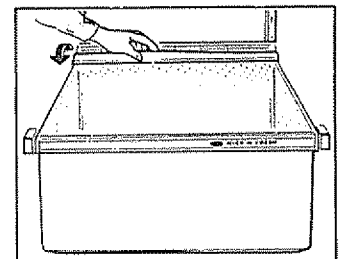

5. Pull the drawer partway out. Reach in, push the rear of the glass up; at the same time, push it back until it clears front-corner retainers.

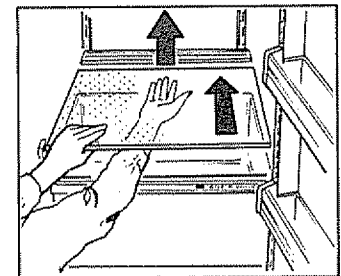

6. Tilt and remove the cover.

7. Pull the drawer forward, lift the front to clear stops, and pull the drawer out until it hits the door. Then lift the drawer up until it is higher than the drawer supports, tilt it and take it out.

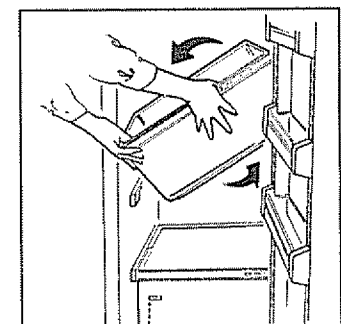

8. If tape holds bottom drawer cover to drawer supports, remove the tape. Pull drawer partway out. Reach in, push the rear of the glass up and, at the same time, back, until it clears front-corner retainers.

9. Tilt and remove the cover.

10. Tilt and remove the drawer.

After cleaning, replace drawers and covers in reverse order. Reinstall the gasket at the rear of the top drawer. Fit the end of the plastic drawer support into the slot on the gasket, with the rubber gasket flap facing you. Make sure the gasket snaps into place.

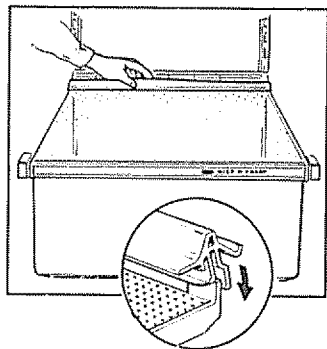

Then replace the light panel by hanging top of panel on upper pins and pushing in at bottom.

Drain Opening in Freezer Compartment

During yearly cleaning, remove the freezer bin and flush a solution of baking soda (one teaspoon) and two cups of hot (not boiling) water through the drain line with the help of a meat baster. This will help eliminate odor and reduce the likelihood of a clogged drain line.

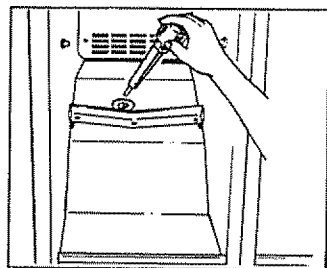

If drain becomes clogged, use a meat baster and baking-soda-and-water solution to force the clog through the drain line. Continue flushing until the line is clear, then empty and replace the defrost water pan immediately.

Condenser

The condenser is located behind the base grille. For most efficient operation, remove the base grille (see page 3) and sweep away or vacuum up dust that is readily accessible. This easy cleaning operation should be done at least once a year.

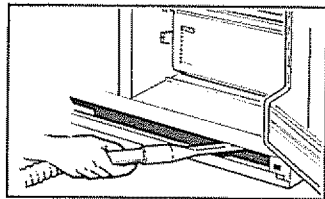

Defrost Water Pan

The pan behind the base grille should be cleaned at least once a year. When reinstalling the pan, firmly push it ALL THE WAY IN until it stops.

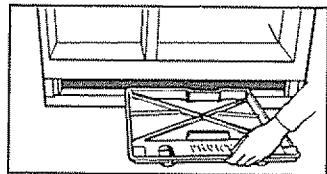

Behind Refrigerator

Take care moving your refrigerator away from the wall. All types of floor coverings can be damaged, particularly cushioned coverings and those with embossed surfaces. Pull the refrigerator straight out and return it to position by pushing it straight in. Moving refrigerator in a side direction may damage floor covering or refrigerator.

Light Bulb Replacement

Unplug refrigerator before changing a light bulb.

Fresh Food Compartment—Upper Light

1. Pull bottom of light panel forward until panel clears pins on rear wall, then rotate panel downward until tabs slide out of slots in control housing.

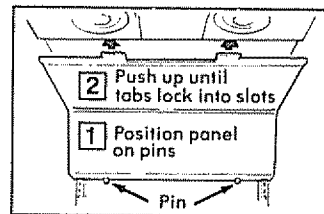

2. After replacing with standard 60-watt bulb, reinstall light panel by (1) sliding tabs at front of light panel into slots in control housing, and (2) flexing rear portion of light panel over pins on rear wall.

Fresh Food Compartment—Lower Light

1. Remove light panel. See Storage Drawers, Step 3, on page 12.

2. After replacing the 40-watt appliance bulb with a same-size bulb, replace light panel by hanging top of panel on upper pins, then pushing in at bottom.

Control Housing

Bulb compartment between freezer and fresh food compartment controls contains two 7-watt screw-in bulbs.

1. Slide bulb compartment cover on underside of control housing back about 1/2 inch and it will drop into your hand.

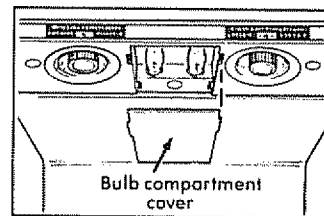

2. Replace with same-size, same-type bulbs.

3. Line up tabs on cover with grooves in control housing and slide cover forward into place.

Freezer Compartment

1. Remove shelf just below light panel. (Shelf will be easier to remove if it is emptied first.)

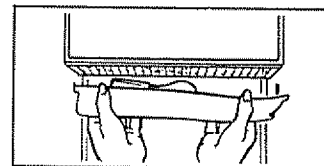

2. Pull plastic light panel toward you. (It will bend to free tabs from grooves.)

3. After replacing with same size bulb, reinstall panel and shelf.

Before You Call for Service

Save time and money. Check this list of causes of minor operating problems you can correct yourself.

Refrigerator does not operate

- May be in defrost cycle when motor does not operate for about 30 minutes.
- Temperature control in OFF position.
- If interior light is not on, refrigerator may not be plugged in at wall outlet.
- If plug is secure and refrigerator fails to operate, plug lamp into same outlet to determine if there is tripped circuit breaker or burned out fuse.

Motor operates for long periods

- Modern refrigerators with more storage space and a larger freezer require more operating time.
- Normal when refrigerator is first delivered to your home—usually requires 24 hours to completely cool down.
- Large amounts of food placed in refrigerator to be cooled or frozen.
- Hot weather—frequent door openings.
- Door left open.
- Temperature controls set too cold. See page 4.
- Condenser needs cleaning. Refer to page 13.
- Check ENERGY-SAVING TIPS on page 4.

Operating sounds

- The high speed compressor motor required to maintain near zero temperatures in the large freezer compartment may produce higher sound levels than your old refrigerator.
- Normal fan air flow—one fan blows cold air through the refrigerator and freezer compartments—another fan cools the compressor motor.
- These NORMAL sounds will also be heard from time to time:
 - Defrost timer switch clicks at defrost.
 - Defrost water dripping into drain pan.
 - Temperature control clicks ON or OFF.
 - Refrigerant boiling or gurgling.
 - Cracking or popping of cooling coils caused by expansion and contraction during defrost and refrigeration following defrost.
 - Ice cubes dropping into the bin and water running in pipes as icemaker refills.

Motor starts & stops frequently

- Temperature control starts and stops motor to maintain even temperatures. This is normal.

Door not closing properly

- Door gasket on hinge side sticking or folding over. To correct, put a small amount of petroleum jelly on face of gasket.

Vibration or rattling

- If refrigerator vibrates, more than likely it is not resting solidly on the floor. The front roller screws need adjusting, or floor is weak or uneven. Refer to page 3.
- If dishes vibrate on shelves, try moving them. Slight vibration is normal.
- Defrost water pan rattling, needs to be positioned properly.

Foods dry out

- Foods not covered, wrapped or sealed properly.

Fresh food or freezer compartment temperature too warm

- Temperature control not set cold enough. Refer to page 4.
- Warm weather—frequent door openings.
- Door left open for long time.
- Package may be holding door open.

Frost or ice crystals on frozen food

- Door may have been left ajar or package holding door open.
- Too frequent or too long door openings.
- Frost within package is normal.

Slow ice cube freezing

- Door may have been left ajar.
- Turn temperature of freezer compartment colder.

Ice cubes have odor/taste

- Old cubes need to be discarded. Empty ice bin every 30 days.
- Ice storage bin needs to be washed.
- Unsealed packages in refrigerator and/or freezer compartments may be transmitting odor/taste to ice cubes.
- Interior of refrigerator needs cleaning. Refer to page 12.

Automatic icemaker does not work

- Icemaker feeler arm in OFF (up) position.
- Water supply turned off or not connected.
- Freezer compartment too warm.
- Cubes too small—water shutoff valve connecting refrigerator to home water line may be clogged.
- Sometimes cubes fuse to the side of the ice mold and hold the feeler arm in the OFF (up) position. Remove this ice to restart the icemaker.
- Piled up cubes in storage bin may cause icemaker to shut off prematurely. With icemaker feeler arm in OFF (up) position, level cubes in bin by hand.
- When leveling cubes by hand, you may have pushed the feeler arm into the OFF (up) position by mistake.

Cube dispenser does not work.

- No ice cubes. Remove storage container. If cubes are frozen to wire arm, remove cubes.
- No ice cubes. Icemaker or water supply turned off.
- Irregular ice clumps in storage container. Break up as many as you can with fingertip pressure and discard the remaining clumps.

Water has poor taste/odor

If water dispenser has not been used for an extended period, dispense water in regular manner until all water in reservoir is replenished with fresh water.

- Poor-tasting incoming water. Install a water filter.

Water dispenser does not work

- Water supply line turned off or not connected.
- Supply line may be clogged with sediment.

Water in first glass is warm

- Allow about 24 hours for water to cool to proper temperature after refrigerator is first installed.
- If water dispenser has not been used for extended period, water in first glass will not be as cool as in succeeding glasses.
- If water reservoir has been drained, allow several hours for replenished supply to chill.

Moisture forms on outside of refrigerator

- Not unusual during periods of high humidity.

Moisture collects inside

- Too frequent or too long door openings.
- In humid weather, air carries moisture into refrigerator when doors are opened.

Water on floor

- The drain in the bottom of the freezer may be clogged. Remove any ice on the freezer bottom and clean the drain. Refer to page 13.
- Defrost water pan full, missing or not in position.

Hot air from bottom of refrigerator

- Normal air flow cooling motor. In the refrigeration process, it is normal that heat be expelled in the area under the refrigerator. Some floor coverings will discolor at these normal and safe operating temperatures. Your floor covering supplier should be consulted if you object to this discoloration.

Interior light does not work

- No power at outlet.
- Light bulb needs replacing. See page 13.

Refrigerator has odor

- Food with strong odors should be tightly covered.
- Check for spoiled food.
- Interior needs cleaning. Refer to page 12.
- Defrost water pan needs cleaning.
- Keep open box of baking soda in refrigerator; replace every three months.

Water Filter Accessory

(optional at extra cost)

Your ice cubes can only be as fresh-tasting as the water that produces them. That's why it's a good idea to purify the water with a water filter.

The water filter is an optional part at extra cost and is available from your Sears Service Center. Order Filter No. 978488 and it may be installed in minutes when attached to the inlet water tube connection.

Water Supply Accessory Kit

(optional at extra cost)

A water supply kit containing copper tubing, shut-off valve, fittings and instructions needed to connect the icemaker to your cold water line is also available from your Sears store or Sears Service Center.

Moving Precautions

Disconnect the power cord from the wall outlet, remove all food and clean and dry the interior. Secure all loose items by taping them securely in place. Keep the refrigerator *in an upright position* during actual moving and in the van. Secure the refrigerator in the van to prevent movement, and protect the outside with a blanket.

Vacation Precautions

For extended vacations or absences, shut off power to the refrigerator, turn the numbered control to the OFF position, and clean the interior with a baking soda solution of one tablespoon of soda to one quart of water. Wipe dry. To prevent odors, leave an open box of soda in the refrigerator. Leave the doors open.

For shorter vacations, remove perishable foods and leave controls at their regular settings. However, if room temperature is expected to drop below 60°F., follow the same instructions as for extended vacations.

Set icemaker to the OFF position and shut off water supply to refrigerator.

SEARS

FULL ONE YEAR WARRANTY ON REFRIGERATOR

For one year from the date of purchase, when this refrigerator is operated and maintained according to instructions attached to or furnished with the product, Sears will repair this refrigerator, free of charge, if defective in material or workmanship.

FULL FIVE-YEAR WARRANTY ON SEALED REFRIGERATION SYSTEM

For five years from the date of purchase, when this refrigerator is operated and maintained according to owner's instructions attached to or furnished with the product, Sears will repair the sealed system (consisting of refrigerant, connecting tubing and compressor motor), free of charge, if defective in material or workmanship.

The above warranty coverage applies only to refrigerators which are used for storage of food for private household purposes.

WARRANTY SERVICE IS AVAILABLE BY CONTACTING THE
NEAREST SEARS SERVICE CENTER/DEPARTMENT IN THE UNITED STATES.

This warranty applies only while this product is in use in the United States.

This warranty gives you specific legal rights,
and you may also have other rights which vary from state to state.

SEARS, ROEBUCK AND CO., Dept. 698/731A, Sears Tower, Chicago, IL 60684

SEARS SERVICE IS AT YOUR SERVICE

Your Kenmore has added value when you consider that Sears has nationwide service units staffed by Sears-trained technicians... professional technicians specifically trained to service SEARS appliances, having the parts, tools and equipment to insure that we meet our pledge to you... "We Service What We Sell!"

ADD TO THE VALUE OF YOUR KENMORE,
BUY A SEARS MAINTENANCE AGREEMENT

Sears Kenmore refrigerators are designed, built and tested for years of dependable use. Yet any modern appliance may need service from time to time. The Sears warranty plus the Sears maintenance agreement give protection from unexpected repair bills. Contact your salesperson or nearest service center for details.

SEARS, ROEBUCK AND CO., Dept. 698/731A, Sears Tower, Chicago, IL 60684

Printed in U.S.A.
162D3810P001

Part No. S596020

59771
59778

388

Free Manuals Download Website

<http://myh66.com>

<http://usermanuals.us>

<http://www.somanuals.com>

<http://www.4manuals.cc>

<http://www.manual-lib.com>

<http://www.404manual.com>

<http://www.luxmanual.com>

<http://aubethermostatmanual.com>

Golf course search by state

<http://golfingnear.com>

Email search by domain

<http://emailbydomain.com>

Auto manuals search

<http://auto.somanuals.com>

TV manuals search

<http://tv.somanuals.com>