

Owner's Manual



Model, Modelo

116.24614

ENGLISH



CAUTION:

Read and follow all safety and operating instructions before first use of this product.

CUIDADO:

Lea y siga todas las instrucciones de operación y seguridad antes del uso de este producto.

Sears, Roebuck and Co., Hoffman Estates, IL 60179 U.S.A.
www.sears.com

Part No. C01ZCNR00U00-KC01ZCNRZ0U0

Printed in U.S.A.
Impreso en EUA

TABLE OF CONTENTS

Before Using Your New Vacuum	2	Canister Care	13
Kenmore Vacuum Cleaner Warranty	2	Bag Changing	13
Important Safety Instructions	3	Cleaning Exterior and Attachments	14
Parts and Features	4-5	Motor Safety Filter Changing	14
Assembly Instructions	6-7	Exhaust Filter Changing	15
Power-Mate Jr.® Storage	7	Power-Mate® Care	15
Use	8	Belt Changing and Agitator Cleaning ..	16-17
How to Start	8	Light Bulb Changing	18
Vacuuming Tips	9	Agitator Servicing	18
Suggested Pile Height Settings	10	Troubleshooting	19
Attachments	10	Requesting Assistance	
Attachment Use Chart	11	Or Service	Back Cover
Performance Features	11-12		
How Your Vacuum Works	13		

BEFORE USING YOUR NEW VACUUM

Please read this guide. It will help you assemble and operate your new Kenmore vacuum in the safest and most effective way.

For more information about vacuum cleaner care and operation, call your nearest Sears store. You will need the complete model and serial numbers when requesting information. Your vacuum's model and serial numbers are located on the Model and Serial Number Plate.

Use the space below to record the model number and serial number of your new Kenmore vacuum.

Model No. _____

Serial No. _____

Date of Purchase _____

Keep this book and your sales check (receipt) in a safe place for future reference.

KENMORE VACUUM CLEANER WARRANTY

LIMITED ONE YEAR WARRANTY ON KENMORE VACUUM CLEANER

This warranty is for one year from the date of purchase, and includes only private household vacuum cleaner use. During the warranty year, when this vacuum cleaner is operated and maintained according to the owner's manual instructions, Sears will repair any defects in material or workmanship free of charge.

This warranty excludes vacuum bags, belts, light bulbs, and filters, which are expendable parts and become worn during normal use.

For warranty service, return this vacuum cleaner to the nearest Sears Service Center in the United States.

This warranty applies only while this product is in use in the United States. This warranty gives you specific legal rights, and you may also have other rights which vary from state to state.

Sears, Roebuck and Co., D/817 WA, Hoffman Estates, IL 60179

IMPORTANT SAFETY INSTRUCTIONS



WARNING

Your safety is important to us. To reduce the risk of fire, electrical shock, injury to persons or damage when using your vacuum cleaner, follow basic safety precautions including the following:

Read all instructions in this manual before assembling or using your vacuum cleaner.

Use your cleaner only as described in this manual. Use only with Sears recommended attachments.

Disconnect electrical supply before servicing or cleaning out brush area. Failure to do so could result in electrical shock or brush suddenly starting.

Do not leave cleaner when plugged in. Unplug from outlet when not in use and before servicing.

To reduce the risk of electrical shock – Do not use outdoors or on wet surfaces.

Do not allow to be used as a toy. Close attention is necessary when used by or near children.

Do not use with damaged cord or plug. If cleaner is not working as it should, has been dropped, damaged, left outdoors, or dropped into water, return it to a Sears Service Centre.

Do not pull or carry by cord, use cord as a handle, close door on cord, or pull cord around sharp edges or corners. Do not run cleaner over cord. Keep cord away from heated surfaces.

Do not unplug by pulling on cord. To unplug, grasp the plug, not the cord.

Do not handle plug or cleaner with wet hands.

Do not put any objects into openings.

Do not use with any opening blocked; keep free of dust, lint, hair and anything that may reduce air flow.

Keep hair, loose clothing, fingers, and all parts of body away from openings and moving parts.

Turn off all controls before unplugging.

Use extra care when cleaning on stairs. Do not put on chairs, tables, etc. Keep on floor.

Do not use cleaner to pick up flammable or combustible liquids (gasoline, cleaning fluids, perfumes, etc.), or use in areas where they may be present. The fumes from these substances can create a fire hazard or explosion.

Do not pick up anything that is burning or smoking, such as cigarettes, matches, or hot ashes.

Do not use cleaner without dust bag and/or filters in place.

Always change the dust bag after vacuuming carpet cleaners or freshener, powders and fine dust. These products clog the bag, reduce airflow and can cause the bag to burst. Failure to change bag could cause permanent damage to the cleaner.

Do not use the cleaner to pick up sharp hard objects, small toys, pins, paper clips, etc. They may damage the cleaner or dust bag.

Do not operate cleaner without the exhaust filter or exhaust filter door in place (if applicable).

The hose contains electrical wires. **Do not** use when damaged, cut, or punctured. Replace if cut or worn. **Do not** pick up sharp objects.

Always turn off and unplug the cleaner before connecting or disconnecting either hose, Handi-Mate Jr.® (if applicable), or nozzle.

Hold plug when rewinding onto cord reel. **Do not** allow plug to whip when rewinding.

You are responsible for making sure that your vacuum cleaner is not used by anyone unable to operate it properly.

SAVE THESE INSTRUCTIONS

Proper assembly and safe use of your vacuum cleaner are your responsibilities. Your cleaner is intended for **household use**. Read this Owner's Manual carefully for important use and safety information. This guide contains safety statements under warning and caution symbols. Please pay special attention to these boxes and follow any instructions given. **WARNING** statements alert you to such dangers as fire, electrical shock, burns and personal injury. **CAUTION** statements alert you to such dangers as personal injury and/or property damage.

ENGLISH

PARTS AND FEATURES

It is important to know your vacuum cleaner's parts and features to ensure its proper and safe use. Review these before using your cleaner.

Item	Part No. In U.S.	Part No. In Canada
Headlight Bulb	20-5240	596181
Belt	20-5218	20-5218C

Power-Mate®

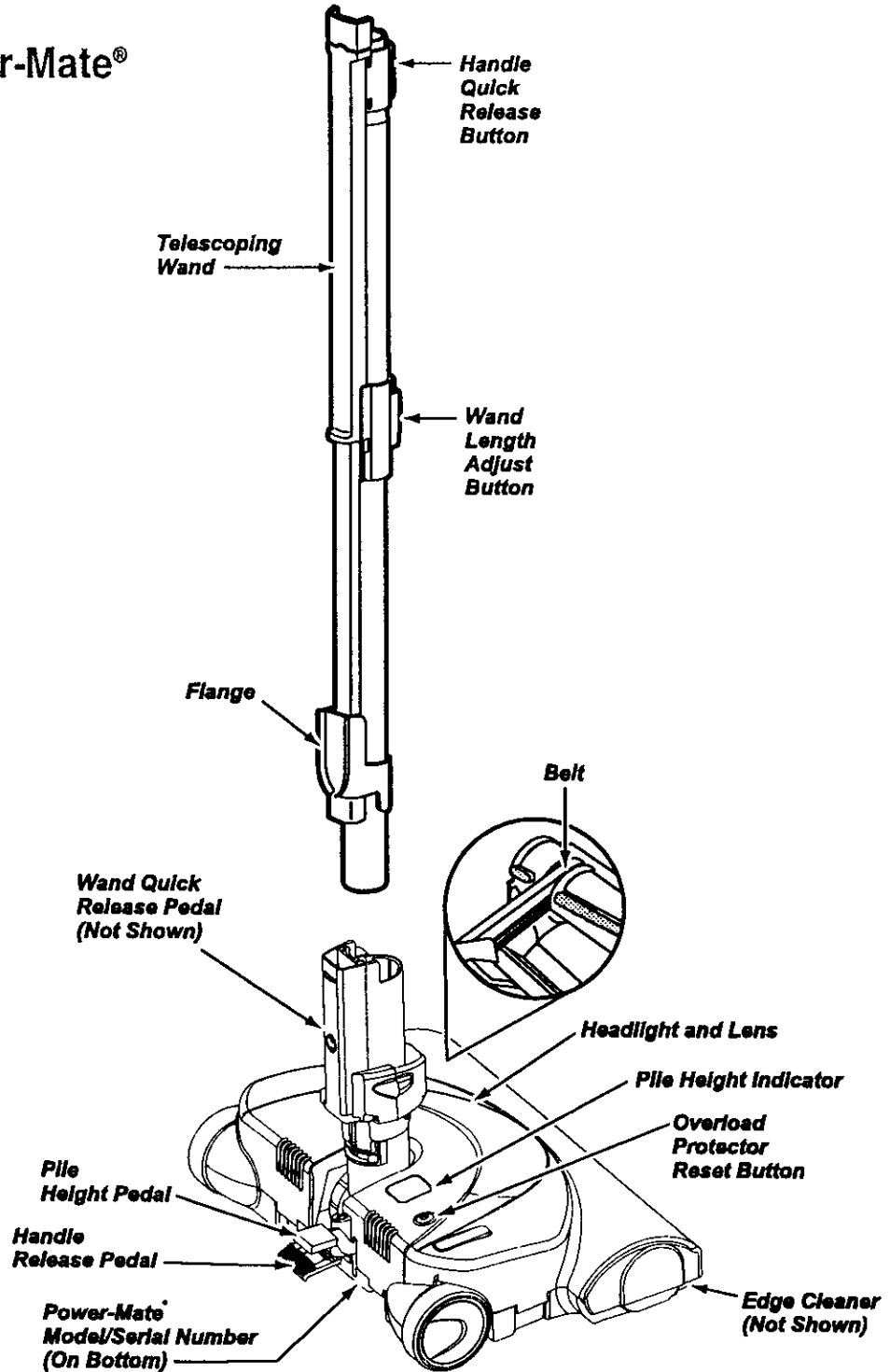

HOSE

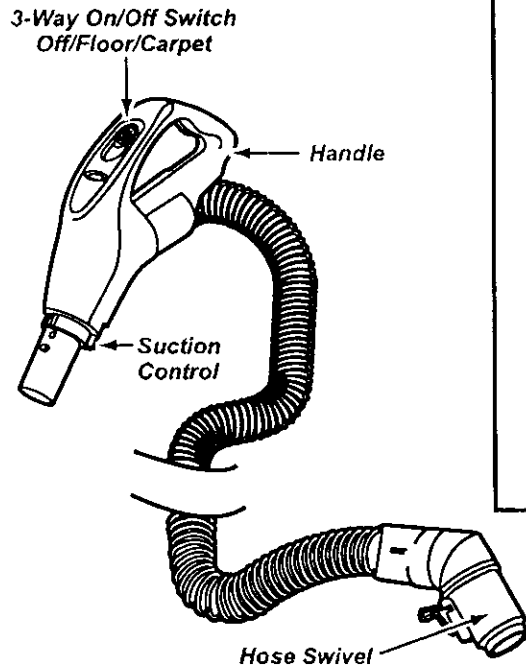

ATTACHMENTS

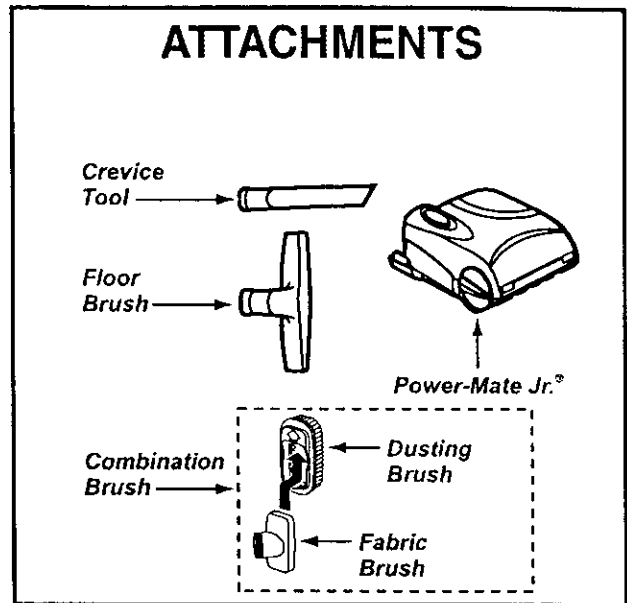

ENGLISH

CANISTER

Item	Part No. In U.S.	Part No. In Canada
Dust Bag	20-50557	20-50557C
Exhaust Filter	20-86889	20-86889C
Motor Safety Filter	20-86883	20-86883C

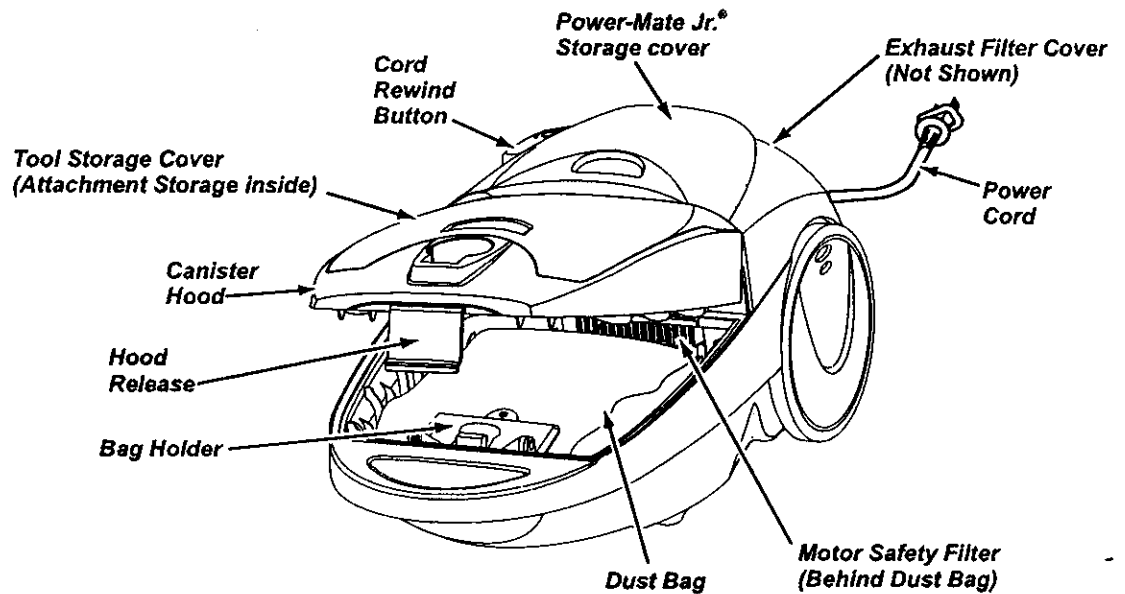

ASSEMBLY INSTRUCTIONS



WARNING

Electrical Shock Hazard
DO NOT plug into electrical supply until assembly is complete. Failure to do so could result in electrical shock or injury.

Before assembling vacuum, check the **PACKING LIST** on the cover of the separate Repair Parts List. Use this list to verify that you have received all the components of your new Kenmore vacuum.

WAND - TELESCOPING

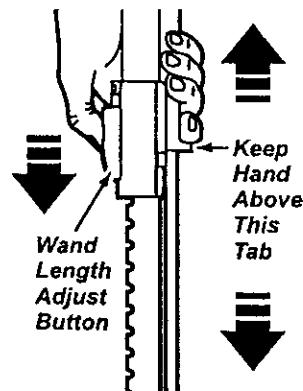

The wand length is adjustable and requires no assembly. To adjust, simply push down on the wand adjust button and slide the upper wand to the desired height.

The swivel, located on the Power-Mate®, allows you to turn the handle to the left side to reach farther under low furniture.

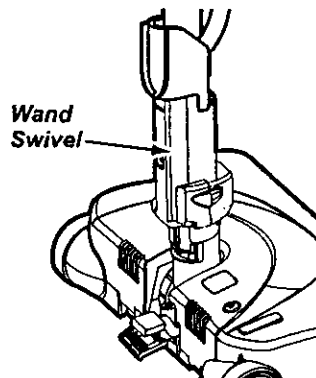

When adjusting the wand length you may have to hold the Power-Mate® with your hand or foot.

POWER-MATE®

Insert wand into Power-Mate® until the wand button snaps into place.

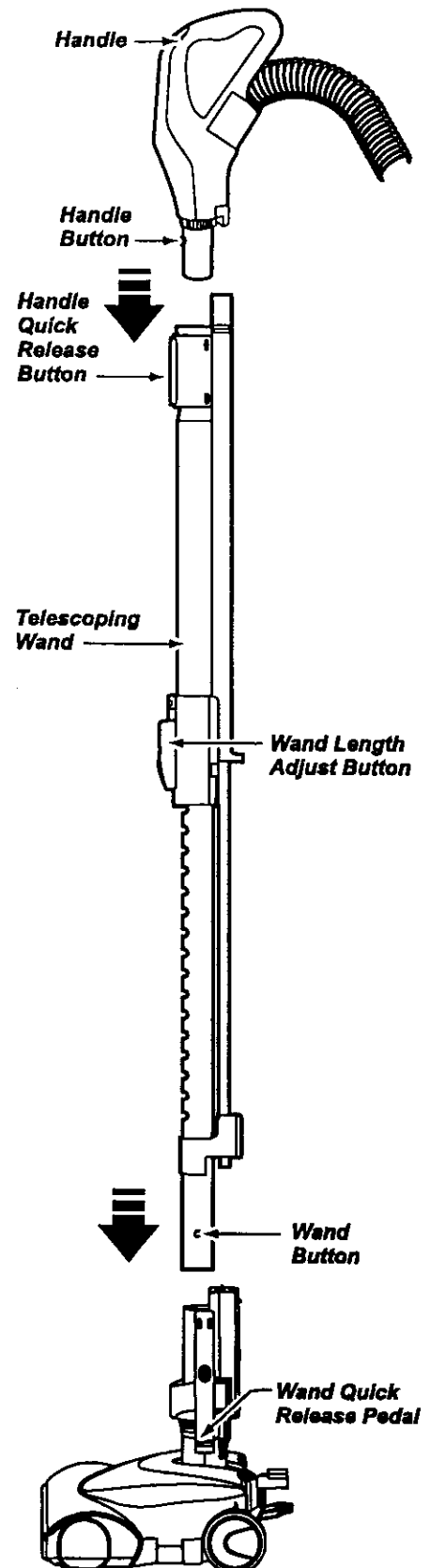

CANISTER

1. Open the canister hood.
2. Check to see that the dust bag is properly installed. See BAG CHANGING for instructions.
3. Check to see that the motor safety filter is properly installed. See MOTOR SAFETY FILTER CLEANING for instructions.

HOOD AND TOOL STORAGE COVER

It is normal for the canister hood and tool storage cover to come off when opened further than needed. Line up the hinge slots, insert the hinges into the slots, and close the hood and tool storage cover to reinstall.



CAUTION

Never open canister hood with the tool storage cover open. This will help to prevent damage from occurring to the canister hood and/or tool storage cover.

HOSE

1. Line up the hose latch tab and notch in canister hood and insert hose into canister until it snaps in place.

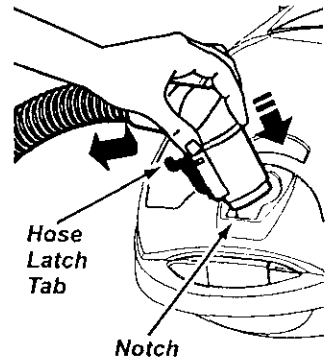

To remove: Lift hose latch tab upward and pull up on hose.

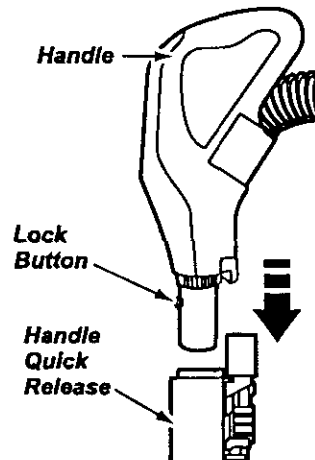

2. Insert handle into wand until lock button snaps in place. **Be sure hose is not twisted.**

To remove: Press handle quick release button and pull up on handle.

To store: Disconnect hose from wands and canister to prevent stress on hose during storage. Store hose in a loosely coiled position so the hose covering is not stressed.

POWER-MATE JR.® STORAGE

This canister is equipped with an on-board storage area for a Power-Mate Jr.® attachment.

To Install:

Open the Power-Mate Jr.® storage cover. Insert the Power-Mate Jr.®, press down into place, and close the lid securely.

To Remove:

Open the storage cover. Remove Power-Mate Jr.® from the storage area and use as needed (see ATTACHMENTS and ATTACHMENT USE).

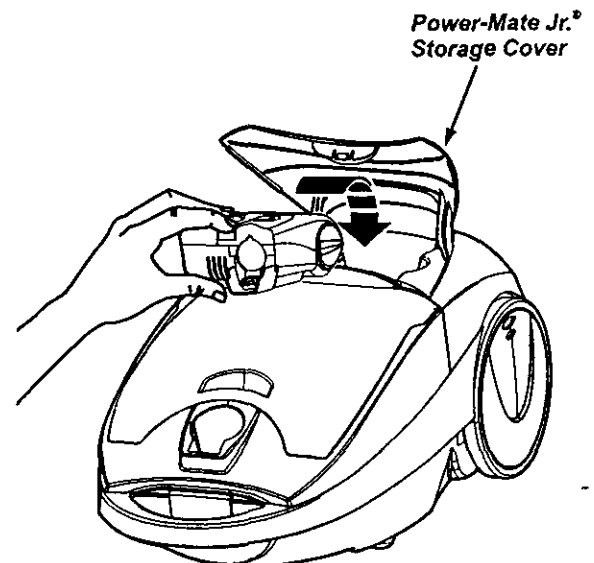

HOW TO START

! WARNING

Personal Injury and Product Damage Hazard

- DO NOT plug in if switch is in ON position. Personal injury or damage could result.
- The cord moves rapidly when rewinding. Keep children away and provide a clear path when rewinding the cord to prevent personal injury.
- DO NOT use outlets above counters. Damage from cord to items in surrounding area could occur.

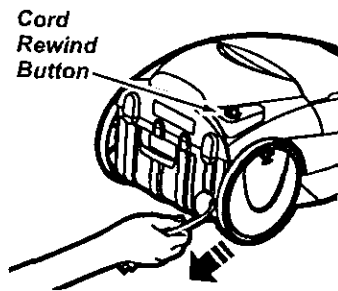

1. Pull cord out of canister to desired length. The cord will not rewind until the cord rewind button is pushed.

NOTE: To reduce the risk of electric shock, this vacuum cleaner has a polarized plug; one blade is wider than the other. This plug will fit in a polarized outlet only one way. If the plug does not fit fully in the outlet, reverse the plug. If it still does not fit, contact a qualified electrician to install the proper outlet. Do not change the plug in any way.

2. Plug the polarized power cord into a 120 Volt outlet located near the floor.

To rewind: Unplug the cleaner. Hold the plug while rewinding to prevent damage or injury from the moving cord. Push cord rewind button.

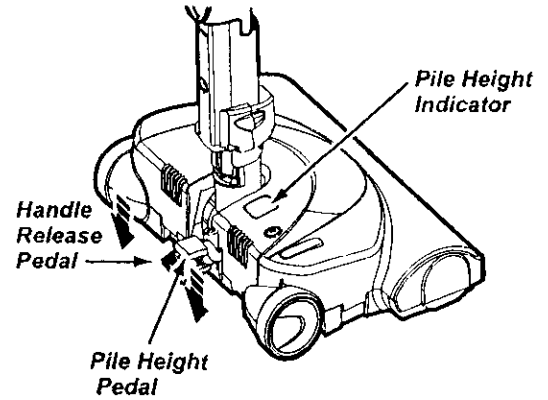
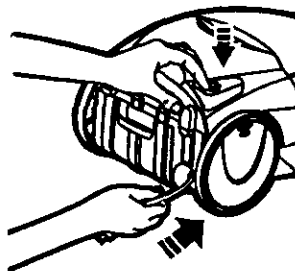

3. Lower wand from upright position by pressing on the handle release pedal.

! CAUTION

DO NOT leave the Power-Mate® running in one spot in the upright position for any length of time. Damage to carpet may occur.

4. Select a pile height setting by pressing the small pedal on the rear of the Power-Mate®. The pile height setting shows on the indicator. See SUGGESTED PILE HEIGHT SETTINGS.

Attention: Refer to your carpet manufacturers cleaning recommendations. Some more delicate carpets may require that they be vacuumed with the Power-Mate® agilator turned off to prevent carpet damage.

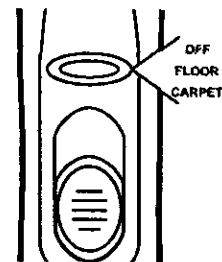

5. Select a switch position on the handle.

OFF

FLOOR - turns on the canister motor only.

CARPET - turns on both the canister and the Power-Mate® motors.

NOTE - When this switch is in the **FLOOR** position, the headlight **DOES NOT** function since no electricity flows to the Power-Mate®.

VACUUMING TIPS

Suggested sweeping pattern.

For best cleaning action, the Power-Mate® should be pushed straight away from you and pulled straight back. At the end of each pull stroke, the direction of the Power-Mate® should be changed to point into the next section to be cleaned. This pattern should be continued across the carpet with slow, gliding motions.

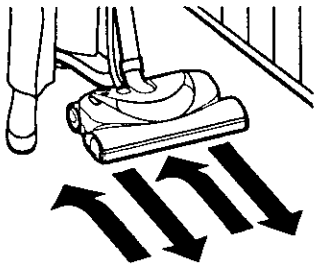

NOTE: Fast, jerky strokes do not provide complete cleaning.

The hose swivel allows the hose to turn without moving the canister. This is helpful for cleaning in small areas. Check hose for twisting before pulling canister.

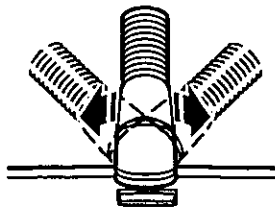

CAUTION

Product Damage Hazard

Use care if the Power-Mate® and wand is left in the upright position as it may tip over easily. Property damage can occur if tipped.

WARNING

Personal Injury and Product Damage Hazard

- **DO NOT** run over power cord with Power-Mate®. Personal injury or damage could result.
- **DO NOT** pull plug from wall by the power cord. If there is damage to the cord or plug, personal injury or property damage could result.

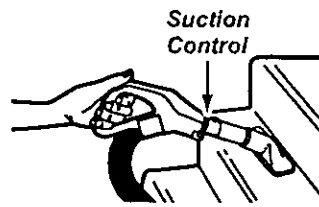

Carpeted stairs need to be vacuumed regularly. For best cleaning results, fully close the suction control.

WARNING

Personal Injury Hazard

Use care if canister is placed on stairs. If it falls, personal injury or property damage could result.

CAUTION

Product Damage Hazard

Do not pull on the hose to move the canister from one stair to the next. When finished cleaning in one area use the handle grip on the canister to move the vacuum to a new location for further cleaning.

The stair grip located on the caster will aid in preventing the canister from slipping when used on stairs (see PERFORMANCE FEATURES).

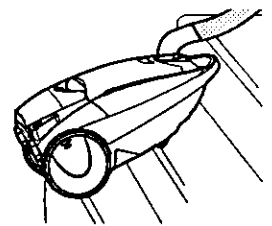

NOTE: Be sure the canister is resting securely on the stairs and the caster is in a locked position before using.

For best cleaning results, keep the airflow passage open. Check each assembly area in HOW YOUR VACUUM WORKS occasionally for clogs. Unplug from outlet before checking.

ENGLISH

SUGGESTED PILE HEIGHT SETTINGS

For best deep down cleaning, use the XLO setting. However, you may need to raise the height to make some jobs easier, such as scatter rugs and some deep pile carpets, and to prevent the vacuum cleaner from shutting off. Suggested settings are:

HI – Shag, deep pile, or scatter rugs.

MED – Medium to deep pile.

LO – Low to medium pile.

XLO – Most carpets and bare floors.

ATTACHMENTS



CAUTION

DO NOT attach or remove handle or wands while cleaner is ON. This could cause sparking and damage the electrical contacts.

ATTACHMENTS ON HANDLE

NOTE: If the Power-Mate® is attached, turn cleaner off before removing handle from wand.

1. Press handle quick release button and pull up on handle.

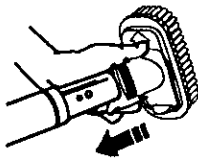
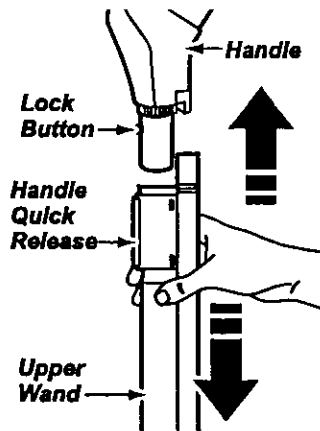

2. Slide attachments firmly on handle as needed. See ATTACHMENT USE CHART.

NOTE: To assemble dusting brush, insert the fabric brush into the dusting brush nozzle and press into place

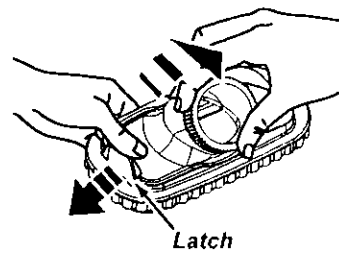
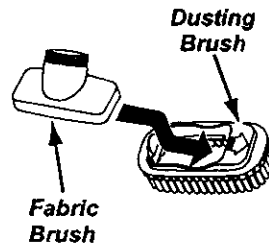

To remove, press latch and lift out.

ATTACHMENTS ON WANDS

1. To remove wands from Power-Mate®, lock wand in straight-up position.

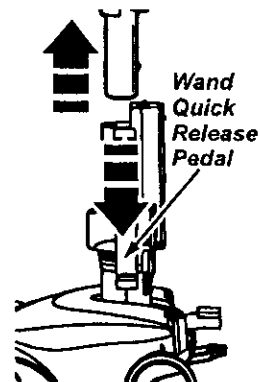
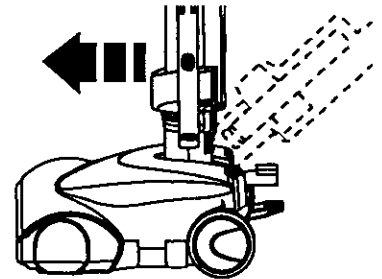



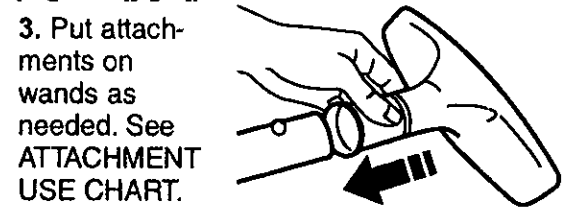



2. Press wand quick release pedal with foot and pull the wand straight up and out of Power-Mate®.



3. Put attachments on wands as needed. See ATTACHMENT USE CHART.

ATTACHMENT USE CHART

ATTACHMENT		CLEANING AREA						
		Furniture*	Between Cushions*	Drapes*	Stairs	Bare Floors	Carpeted Floors/Rugs	Walls
Combination brush	Dusting brush 	X		X				X
	Fabric brush 	X		X				
Crevice tool 		X	X					
Floor brush 					X	X		X
Power-Mate® 						X**	X	
Handi-Mate Jr.® (Some Models)*** 		X			X			
Power-Mate Jr.® (Some Models)*** 		X			X			

* Always clean attachments before using on fabrics. ** 3-way On/Off switch should be in FLOOR position.

*** Handi-Mate Jr.® and Power-Mate Jr.® attachment instructions are included with the products.

NOTE: When separating wands, depress lock button completely before pulling wands apart. If wand lock button is difficult to depress, push the two wands more tightly together to line up the lock button with the hole. Depress lock button and then pull wands apart.

PERFORMANCE FEATURES

EDGE CLEANER

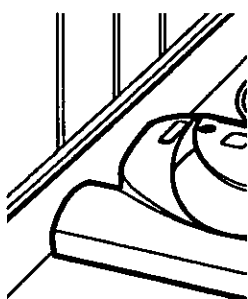

Active brush edge cleaners are on both sides of the Power-Mate®. Guide either side of the Power-Mate® along baseboards or next to furniture to help remove dirt trapped at carpet edges.

OVERLOAD PROTECTOR

The Power-Mate® has built-in protection against motor and belt damage should the agitator jam. If the agitator slows down or stops, the overload protector shuts off the Power-Mate®. The canister motor will continue to run.

Overload Protector Reset Button



To correct problem: Turn off vacuum, remove obstruction, then press reset button.

To reset: Press the overload protector button. A ball point pen may be required.

SUCTION CONTROL

The suction control allows you to change the vacuum suction for different fabrics and carpet weights. Opening the control decreases suction for draperies and lightweight rugs, while closing the control increases suction for upholsteries and carpets.

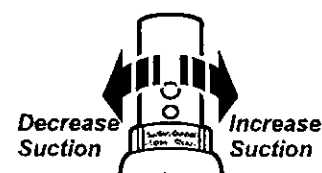

WARNING

Personal Injury Hazard
Always unplug the vacuum cleaner before cleaning the agitator area as brush may suddenly restart. Failure to do so can result in personal injury.

POWER-MATE® STORAGE

The lower wand has a "U" shaped flange in the area where the power cord attaches. The base has a "U" shaped slot near the front.

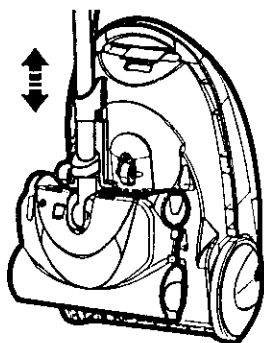

The flange allows the wands and Power-Mate® to be stored with the canister to conserve storage space. The canister must be stored on end for this feature to be used.

To attach the Power-Mate®, it must be in the flat position as shown in the illustration. Use the handle release pedal to place it in this position.

The wand will slip out of the slot as it is lifted up for use and will slide into the slot as it is lowered for storage.

THERMAL PROTECTOR

This vacuum has a thermal protector which automatically trips to protect the vacuum from overheating. The thermal protector turns the motor off automatically to allow the motor to cool in order to prevent possible damage to the vacuum.

To reset: Turn off and unplug the vacuum from the outlet to allow the vacuum to cool. **Check for and remove any clogs. Also check and replace any clogged filters. Wait approximately 50 minutes and plug the vacuum in and turn back on to see if the thermal protector has reset. In some cases, the unit may suddenly restart. DO NOT leave unattended.**

ELECTRONIC BAG/HOSE CHECK INDICATOR

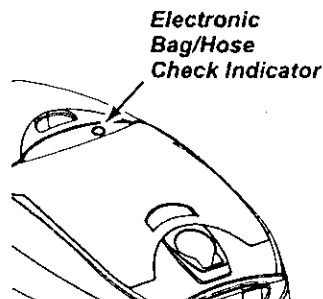

The light comes on whenever the airflow becomes blocked, dust bag needs changing or canister safety filter needs cleaning.

NOTE: The light may come on when using certain attachments, due to reduced airflow through attachment.

Refer to TROUBLESHOOTING.

STAIR GRIP

During normal operation while the vacuum is in the horizontal position, the caster wheel rotates freely 360°.

The Stair Grip feature allows the caster wheel to lock in position when the unit is rotated 25° from horizontal into a vertical position in order for the vacuum to rest on stairs.

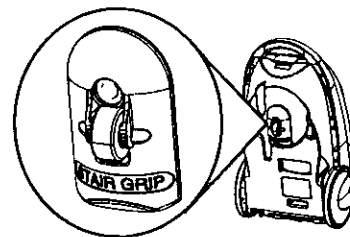

HOW YOUR VACUUM WORKS

The vacuum cleaner creates suction that picks up dirt. Rapidly moving air carries the dirt to the dust bag through the airflow passages. The dust bag lets the air pass through, while it traps the dirt.

For best cleaning results, keep the airflow passage open. Check the starred areas occasionally for clogs. Unplug from outlet before checking.

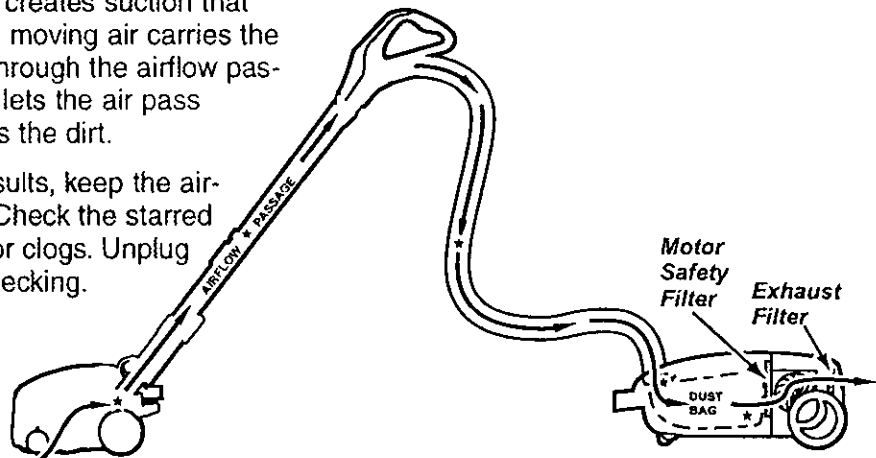

ENGLISH

CANISTER CARE

BAG CHANGING

For best cleaning results, the dust bag should be changed often. The electronic bag/hose check indicator will come on when the bag needs to be changed or the airflow is blocked.

NOTE: See PARTS AND FEATURES for Bag Number.

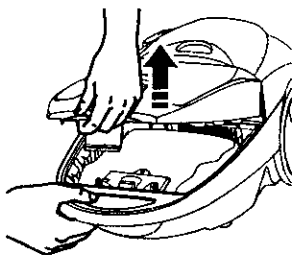

1. Unplug cord from wall outlet.
2. Remove hose from canister.
3. Pull hood release out and up, then lift canister hood.

4. Disengage cardboard tab from red bag mount by pulling away and lifting up.

5. Pull bag out of the red bag mount.

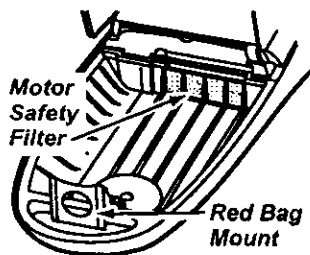

6. Check the motor safety filter and replace, if necessary.

7. The red bag mount will flip forward after removing bag. This will prevent the lid from closing until a new bag is installed.

Note: DO NOT bend or crease the middle of the cardboard when installing the bag into the bag mount slots.

8. Rotate red bag mount down and install bag into slots per instructions pushing down until the cardboard tab locks into position and the holes align.

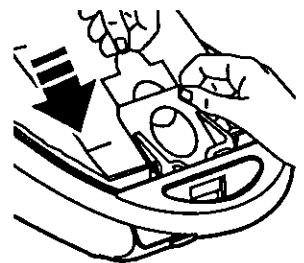

Tuck the bag securely into the bag cavity so that none of it is able to be pinched by the hood.

9. Close and latch canister hood.
10. Reinstall hose.
11. Plug cord into wall outlet.



CAUTION

NEVER REUSE A DUST BAG. Very fine materials, such as carpet freshener, face powder, fine dust, plaster, soot, new carpet lint, etc. can clog the bag and cause it to burst before it is full and may cause damage to vacuum motor. Change bag more often when vacuuming these materials.

CLEANING EXTERIOR AND ATTACHMENTS

1. Unplug cord from wall outlet. **DO NOT** drip water on cleaner.
2. Clean exterior using a clean, soft cloth that has been dipped in a solution of mild liquid detergent and water, then wrung dry. Wipe dry after cleaning.
3. To reduce static electricity and dust build-up, wipe outer surface of cleaner and attachments.



CAUTION

Do not use attachments if they are wet. Attachments used in dirty areas, such as under a refrigerator, should not be used on other surfaces until they are washed. They could leave marks.

MOTOR SAFETY FILTER CHANGING

Check motor safety filter occasionally and change when dirty.



WARNING

Electrical Shock Hazard

Unplug power cord from electrical outlet. Do not operate the cleaner without the motor safety filter. Be sure the filter is dry and properly installed to prevent motor failure and/or electrical shock.

Remove the bag as outlined in the BAG CHANGING section.

MOTOR SAFETY FILTER ELECTROSTATIC

This white filter must be replaced when dirty. It should be replaced regularly depending on use conditions. **The filter CANNOT be washed as it will lose its dust trapping ability.**

NOTE: See PARTS AND FEATURES for motor safety filter number.

1. Lift the rubber retainer and pull out motor safety filter as shown.

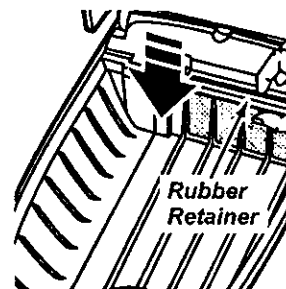
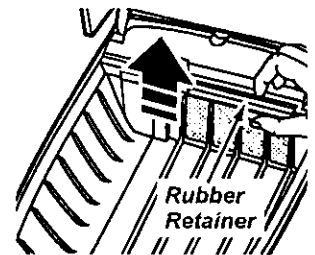

2. Replace the filter, **white side out**, facing the dust bag, by sliding it back into place under the ribs in the bag cavity. Tuck filter in so that it fits completely under the rubber retainer.

3. Replace the bag as outlined in the BAG CHANGING section.

EXHAUST FILTER CHANGING



WARNING

Fire and/or Electrical Shock Hazard
Do not operate with a clogged exhaust filter or without the exhaust filter or exhaust filter cover installed.

EXHAUST FILTER HEPA

The exhaust filter cartridge must be replaced when dirty. Replace the filter when the entire surface area is covered evenly. **The filter CANNOT be washed as it will lose its dust trapping ability.**

NOTE: See PARTS AND FEATURES for exhaust filter number.

1. Pull out and up on the exhaust filter cover to remove from the vacuum and lay aside.

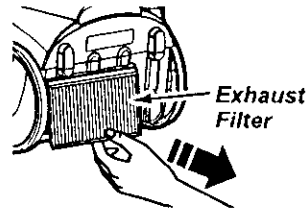
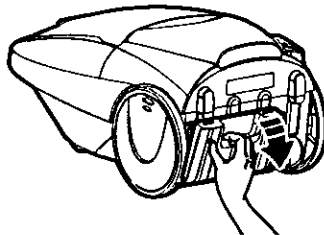

2. Pull the exhaust filter up and out from the rear of the vacuum.

3. Replace the exhaust filter cartridge. Place the new filter into the vacuum with the foam seal facing towards the vacuum.

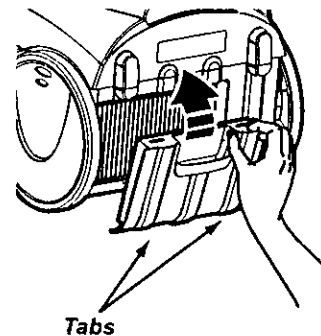
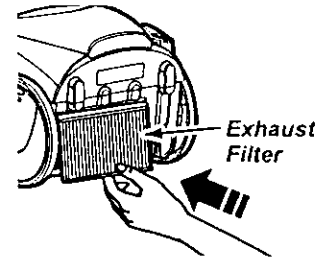

4. Replace the exhaust filter cover by placing the two tabs on the filter cover into the slots on the vacuum and rotate into place until it snaps closed.

ENGLISH

POWER-MATE® CARE

Always follow all safety precautions when cleaning and servicing the Power-Mate®.



WARNING

Electrical Shock Or Personal Injury Hazard

Disconnect electrical supply before servicing or cleaning the unit. Failure to do so could result in electrical shock or personal injury from cleaner suddenly starting.

BELT CHANGING AND AGITATOR CLEANING

TO REMOVE BELT

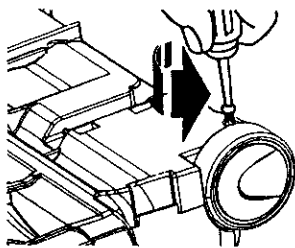

1. Turn Power-Mate® upside down.

2. Unscrew the two (2) Power-Mate® cover screws.

3. Turn Power-Mate® right side up. Press handle release pedal and lower the swivel. Lift rear latches up.

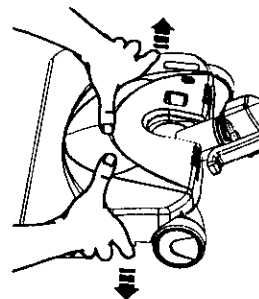
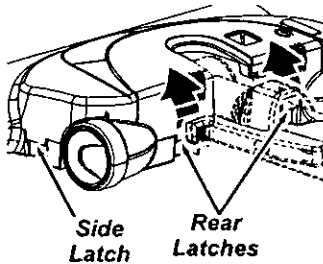

4. To remove cover, grasp the sides and pull out.

5. Lift agitator assembly out and remove worn belt.

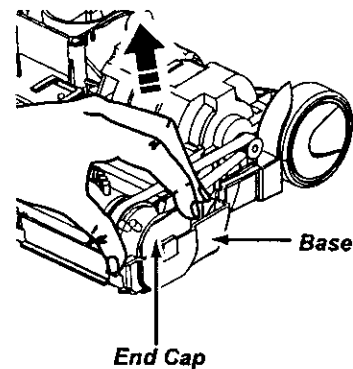

6. Check and clean end cap areas. See AGITATOR ASSEMBLY for picture of complete agitator assembly.

TO CLEAN AGITATOR:

NOTE: In order to keep cleaning efficiency high and to prevent damage to your vacuum, the agitator must be cleaned every time the belt is changed.

The agitator must also be cleaned according to the following schedule:

<u>Vacuum Use</u>	<u>Clean Agitator</u>
HEAVY - (used daily)	every week
MODERATE - (used 2-3 times/week)	every month
LIGHT - (used 1 time/week)	every 2 months

IMPORTANT

Disconnect cleaner from electrical outlet. Check and remove hair, string and lint build-up frequently in the Power-Mate® agitator and end cap areas.

Remove any dirt or debris in the belt path area or in the brush roller area.

Carefully remove any string or debris located on the agitator, or end caps.

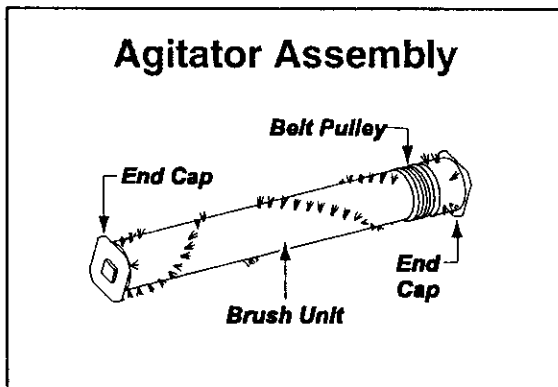

TO REPLACE BELT

1. Install new belt over motor drive, then over brush sprocket.

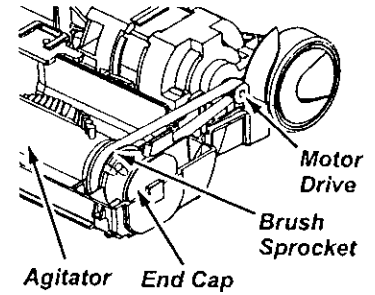

NOTE: See PARTS AND FEATURES for belt number.

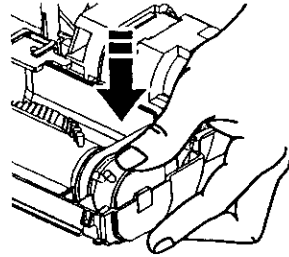

2. Place agitator assembly back into Power-Mate®.

ENGINE

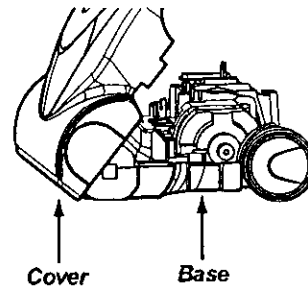

3. Line up front of cover and base. Rest cover on front edge of base as shown.

4. Rotate cover back. Press cover firmly until side and rear tabs snap into place.

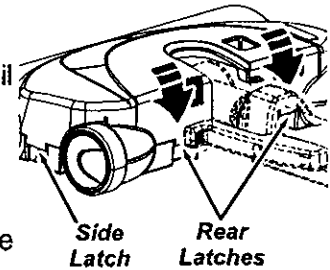

Make sure there is no gap between the cover and base.

5. Turn Power-Mate® upside down and replace two (2) cover screws.

LIGHT BULB CHANGING

1. Remove Power-Mate® cover as shown in BELT CHANGING AND AGITATOR CLEANING section.

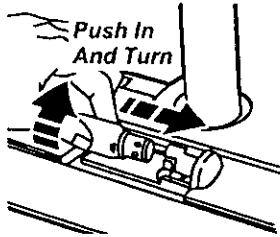

2. Push in and turn bulb counterclockwise, then pull out to remove.

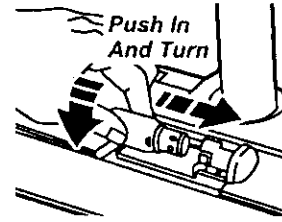

3. Push in and turn bulb clockwise, to replace. Bulb must not be higher than 15 Watts(130 Volts).

4. Reinstall Power-Mate® cover as shown in BELT CHANGING AND AGITATOR CLEANING section.

NOTE: See PARTS AND FEATURES for bulb number.

AGITATOR SERVICING



WARNING

Electrical Shock Or Personal Injury Hazard

Disconnect electrical supply before servicing or cleaning the unit. Failure to do so could result in electrical shock or personal injury from cleaner suddenly starting.

TO CHECK AGITATOR ASSEMBLY

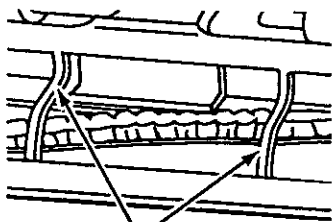

Base Support Bars

When brushes are worn to the level of the base support bars, replace the agitator assembly.

TO REPLACE AGITATOR ASSEMBLY

1. Remove Power-Mate® cover, belt and agitator assembly. See "To Remove Belt" in BELT CHANGING AND AGITATOR CLEANING.

2. Replace Agitator

3. Replace belt, agitator assembly, Power-Mate® cover, light bulb and light cover. See "To replace belt" in BELT CHANGING AND AGITATOR CLEANING.

TROUBLESHOOTING

Review this table to find do-it-yourself solutions for minor performance problems. Any service needed, other than those described in this owner's manual, should be performed by an authorized Sears Service Center.



WARNING Electrical Shock Hazard

Disconnect electrical supply before servicing or cleaning the unit. Failure to do so could result in electrical shock or personal injury.

PROBLEM	POSSIBLE CAUSE	POSSIBLE SOLUTION
Cleaner won't start.	<ol style="list-style-type: none"> 1. Unplugged at wall outlet. 2. Tripped circuit breaker/blown fuse at household service panel. 3. Loose hose electrical connections. 	<ol style="list-style-type: none"> 1. Plug in firmly, push ON/OFF switch to ON. 2. Reset circuit breaker or replace fuse. 3. Reconnect hose ends, (page 7).
Poor job of dirt pick-up.	<ol style="list-style-type: none"> 1. Full or clogged dust bag. 2. Clogged airflow passages. 3. Dirty filters. 4. Wrong pile height setting. 5. Suction control is open. 6. Hole in hose. 7. Worn Power-Mate® agitator. 8. Worn or broken belt. 9. Dirty agitator or end caps. 10. Canister hood open. 	<ol style="list-style-type: none"> 1. Change bag, (page 13). 2. Clear airflow passages, (page 13). 3. Change filters, (page 14-15). 4. Adjust setting, (page 10). 5. Adjust control, (page 11). 6. Replace hose. 7. Change agitator, (page 18). 8 & 9. See BELT CHANGING AND AGITATOR CLEANING, (pages 16-17). 10. Close and latch hood.
Cleaner starts but cuts off.	<ol style="list-style-type: none"> 1. Hose or hood electrical connections. 2. Tripped overload protector in Power-Mate®. 3. Tripped thermal protector in canister. 	<ol style="list-style-type: none"> 1. Check connections, reconnect hose ends, (page 7). 2. Remove any items that may be caught or jammed, then reset. If cleaner starts and stops again, clean agitator and end caps, then reset, (pages 11, 16-17). 3. Reset thermal protector, (page 12).
Power-Mate® will not run when attached.	<ol style="list-style-type: none"> 1. Power-Mate® connections unplugged. 2. Worn or broken belt. 3. Dirty agitator or end caps. 4. Tripped overload protector in Power-Mate®. 5. Switch not in CARPET position. 	<ol style="list-style-type: none"> 1. Plug in firmly, (page 6). 2 & 3. See BELT CHANGING AND AGITATOR CLEANING, (pages 16-17). 4. Check agitator area for excessive lint build-up or jamming. Clean agitator and end caps, then reset, (pages 11, 16-17). 5. Move switch to CARPET position, (page 8).
Electronic Bag/Hose Check Indicator activates.	<ol style="list-style-type: none"> 1. Full or clogged dust bag. 2. Dirty filters. 3. Blocked airflow passage. 4. Certain attachment tools. 	<ol style="list-style-type: none"> 1. Change bag, (page 13). 2. Change filters, (page 14-15). 3. Clear blockage from airflow passage, (page 13). 4. This is normal. Light should go off when tool is removed.
Cleaner picks up moveable rugs -or- Power-Mate® pushes too hard.	<ol style="list-style-type: none"> 1. Wrong pile height setting. 2. Suction too strong. 	<ol style="list-style-type: none"> 1. Adjust setting, (page 10). 2. Open suction control, (page 11).
Light won't work.	<ol style="list-style-type: none"> 1. Burned out light bulb. 	<ol style="list-style-type: none"> 1. Change light bulb, (page 17).
Cord won't rewind.	<ol style="list-style-type: none"> 1. Dirty power cord. 2. Cord jammed. 	<ol style="list-style-type: none"> 1. Clean the power cord. 2. Pull out cord and rewind.
Cleaner leaves marks on carpet.	<ol style="list-style-type: none"> 1. Wrong vacuuming pattern. 	<ol style="list-style-type: none"> 1. See VACUUMING TIPS, (page 9).

16101010

NOTES

Get it fixed, at your home or ours!

Your Home

For repair - **in your home** - of **all** major brand appliances, lawn and garden equipment, or heating and cooling systems, **no matter who made it, no matter who sold it!**

For the replacement parts, accessories and owner's manuals that you need to do-it-yourself.

For Sears professional installation of home appliances and items like garage door openers and water heaters.

1-800-4-MY-HOME[®] Anytime, day or night
(1-800-469-4663) (U.S.A. and Canada)

www.sears.com

www.sears.ca

Our Home

For repair of carry-in products like vacuums, lawn equipment, and electronics, call or go on-line for the nearest **Sears Parts and Repair Center.**

1-800-488-1222 Anytime, day or night (U.S.A. only)

www.sears.com

To purchase a protection agreement (U.S.A.) or maintenance agreement (Canada) on a product serviced by Sears:

1-800-827-6655 (U.S.A.)

1-800-361-6665 (Canada)

Para pedir servicio de reparación a domicilio, y para ordenar piezas:

1-888-SU-HOGARSM
(1-888-784-6427)

Au Canada pour service en français:

1-800-LE-FOYER^{MC}
(1-800-533-6937)
www.sears.ca

SEARS

© Sears, Roebuck and Co.

® Registered Trademark / ™ Trademark / SM Service Mark of Sears, Roebuck and Co.

® Marca Registrada / ™ Marca de Fábrica / SM Marca de Servicio de Sears, Roebuck and Co.

^{MC} Marque de commerce / ^{MD} Marque déposée de Sears, Roebuck and Co.

Free Manuals Download Website

<http://myh66.com>

<http://usermanuals.us>

<http://www.somanuals.com>

<http://www.4manuals.cc>

<http://www.manual-lib.com>

<http://www.404manual.com>

<http://www.luxmanual.com>

<http://aubethermostatmanual.com>

Golf course search by state

<http://golfingnear.com>

Email search by domain

<http://emailbydomain.com>

Auto manuals search

<http://auto.somanuals.com>

TV manuals search

<http://tv.somanuals.com>