

Owner's Manual



Vacuum Cleaner

Model 116.32734
 116.32735

ENGLISH

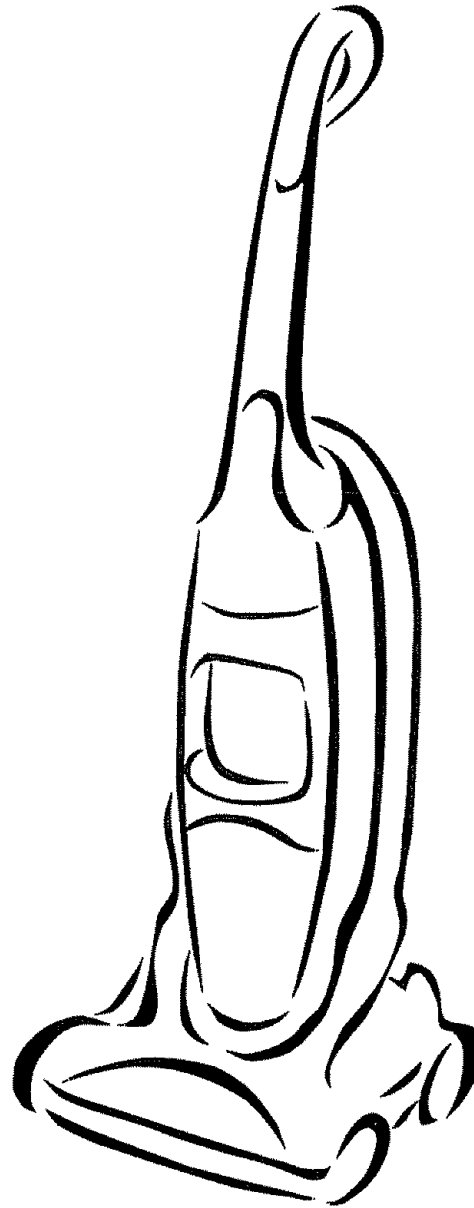

CAUTION:

Read and follow all safety and operating instructions before first use of this product.

Sears, Roebuck and Co., Hoffman Estates, IL 60179 U.S.A.
www.sears.com

Part No. CØ1ZCBTØØUØØ-8192496

Printed in U.S.A.

TABLE OF CONTENTS

Before Using Your New Vacuum	2	Vacuum Cleaner Care	14
Kenmore Vacuum Cleaner Warranty	2	Vacuum Storage	14
Important Safety Instructions	3	Cleaning Exterior and Attachments	14
Parts and Features	4	Dust Bin Cleaning	15-16
Assembly Instructions	5-6	Secondary Screen Cleaning	16
Operating Instructions	7	Filter Changing/Cleaning	17
Getting Started	7	Clog Removal	18
Pile Height Selection and Setting	7	Light Bulb Changing	19
Off/Floor/Carpet Switch	8	Agitator Cleaning	20
Releasing the Handle	8	Valve Cleaning	20
Attachments	9-11	Belt Changing	21
Attachment Use Chart	11	Troubleshooting	22
Vacuuming Tips	11	Requesting service	(back page)
Performance Features	12-13		

BEFORE USING YOUR NEW VACUUM

Please read this guide. It will help you assemble and operate your new Kenmore vacuum in the safest and most effective way.

For more information about vacuum cleaner care and operation, call your nearest Sears store. You will need the complete model and serial numbers when requesting information. Your vacuum's model and serial numbers are located on the Model and Serial Number Plate.

Use the space below to record the model number and serial number of your new Kenmore vacuum.

Model No. _____

Serial No. _____

Date of Purchase _____

Keep this book and your sales check (receipt) in a safe place for future reference.

KENMORE VACUUM CLEANER WARRANTY

LIMITED ONE YEAR WARRANTY ON KENMORE VACUUM CLEANER

This warranty is for one year from the date of purchase, and includes only private household vacuum cleaner use. During the warranty year, when this vacuum cleaner is operated and maintained according to the owner's manual instructions, Sears will repair any defects in material or workmanship free of charge.

This warranty excludes vacuum bags, belts, light bulbs, and filters, which are expendable parts and become worn during normal use.

For warranty service, return this vacuum cleaner to the nearest Sears Service Center in the United States.

This warranty applies only while this product is in use in the United States. This warranty gives you specific legal rights, and you may also have other rights which vary from state to state.

Sears, Roebuck and Co., D/817 WA, Hoffman Estates, IL 60179

IMPORTANT SAFETY INSTRUCTIONS



WARNING

Your safety is important to us. To reduce the risk of fire, electrical shock, injury to persons or damage when using your vacuum cleaner, follow basic safety precautions including the following:

Read this manual before assembling or using your vacuum cleaner.

Use your cleaner only as described in this manual. Use only with Sears recommended attachments.

To reduce the risk of electrical shock – **Do not** use outdoors or on wet surfaces.

Disconnect electrical supply before any servicing or cleaning. Failure to do so could result in electrical shock or personal injury.

Always turn cleaner off before unplugging.

Do not unplug by pulling on cord. To unplug, grasp the plug, not the cord.

Do not use with damaged cord or plug. If cleaner is not working as it should, has been dropped, damaged, left outdoors, or dropped into water, return it to a Sears Service Center.

Do not pull or carry by cord, use cord as a handle, close door on cord, or pull cord around sharp edges or corners. Do not run cleaner over cord. Keep cord away from heated surfaces.

Do not leave cleaner when plugged in. Unplug from outlet when not in use and before servicing.

Do not allow to be used as a toy. Close attention is necessary when used by or near children.

Do not handle plug or cleaner with wet hands.

Do not put any objects into openings. **Do not** use with any opening blocked; keep free of dust, lint, hair and anything that may reduce air flow.

Keep hair, loose clothing, fingers, and all parts of body away from openings and moving parts.

Do not use cleaner without dust bin and/or filters in place.

Always clean the dust bin after vacuuming carpet cleaners or freshener, powders and fine dust. These products clog the filters, reduce airflow and can cause damage to the cleaner. Failure to clean the dust bin could cause permanent damage to the cleaner.

Do not use the cleaner to pick up sharp hard objects, small toys, pins, paper clips, etc. They may damage the cleaner or dust bin.

Do not pick up anything that is burning or smoking, such as cigarettes, matches, or hot ashes.

Do not use cleaner to pick up flammable or combustible liquids (gasoline, cleaning fluids, perfumes, etc.), or use in areas where they may be present. The fumes from these substances can create a fire hazard or explosion.

Use extra care when cleaning on stairs. Do not put on chairs, tables, etc. Keep on floor.

You are responsible for making sure that your vacuum cleaner is not used by anyone unable to operate it properly.

SAVE THESE INSTRUCTIONS

Proper assembly and safe use of your vacuum cleaner are your responsibilities. Your cleaner is intended only for household use. Read this Owner's Manual carefully for important use and safety information. This guide contains safety statements under warning and caution symbols. Please pay special attention to these boxes and follow any instructions given. **WARNING** statements alert you to such dangers as fire, electrical shock, burns and personal injury. **CAUTION** statements alert you to such dangers as personal injury and/or property damage.

ENGLISH

PARTS AND FEATURES

Item	Part No. In U.S.	Part No. In Canada
Exhaust Filter	20-86889	20-86889C
Headlight Bulb	20-5248	20-5248C
Filter	20-82720	20-82720C
Belt	20-5215	20-52150C

It is important to know your vacuum cleaner's parts and features to assure its proper and safe use. Review these before using your cleaner.

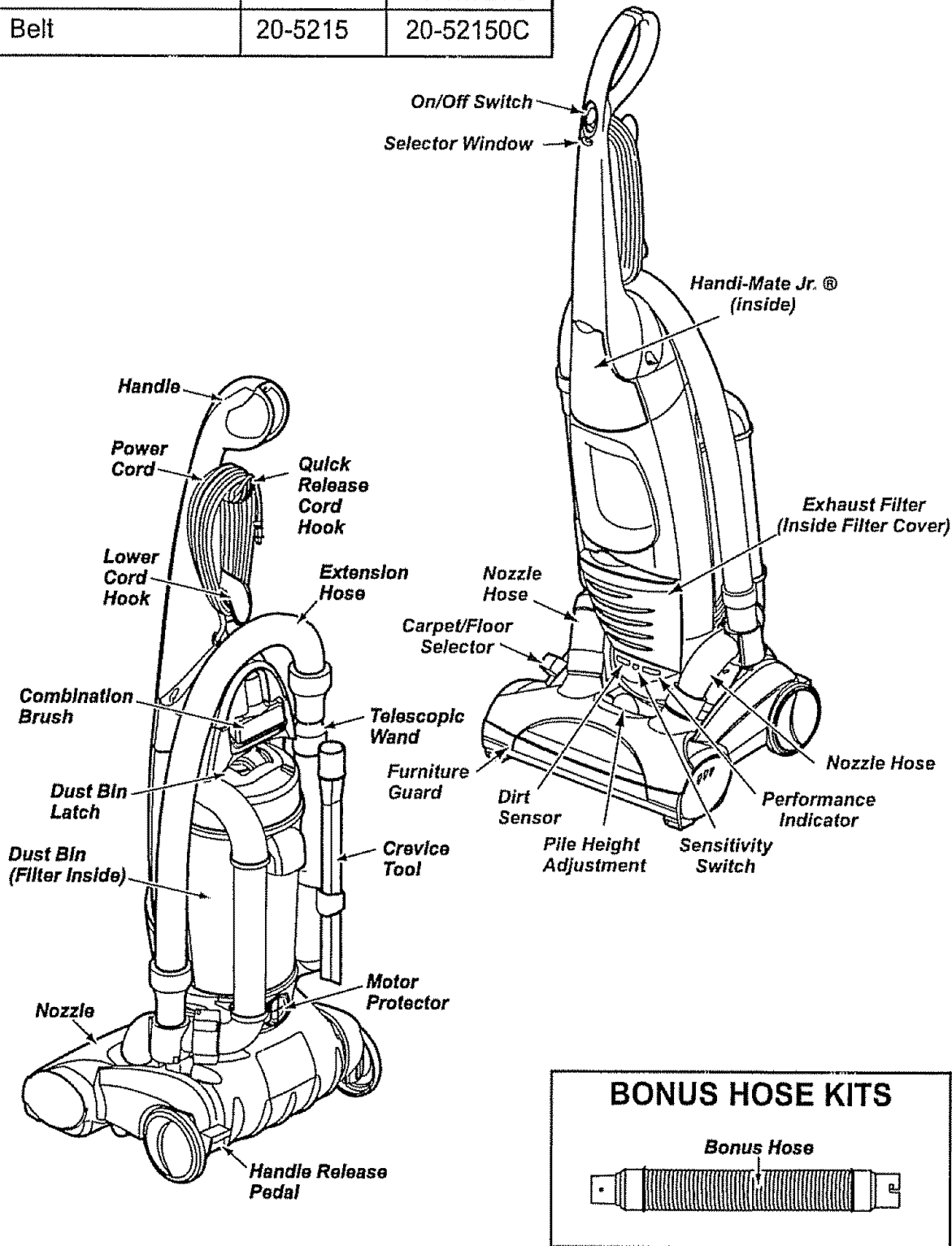

ASSEMBLY INSTRUCTIONS



WARNING

Electrical Shock Hazard
Do not plug into the electrical supply until the assembly is complete. Failure to do so could result in electrical shock or injury.

Before assembling vacuum, check the PACKING LIST on the cover of the separate Repair Parts List. Use this list to verify that you have received all the components of your new Kenmore vacuum.

Remove shipping tape from dust bin latch, and belt cover.

HANDLE ASSEMBLY

Remove the two (2) handle screws located in the body

Position the handle as shown in the illustration below

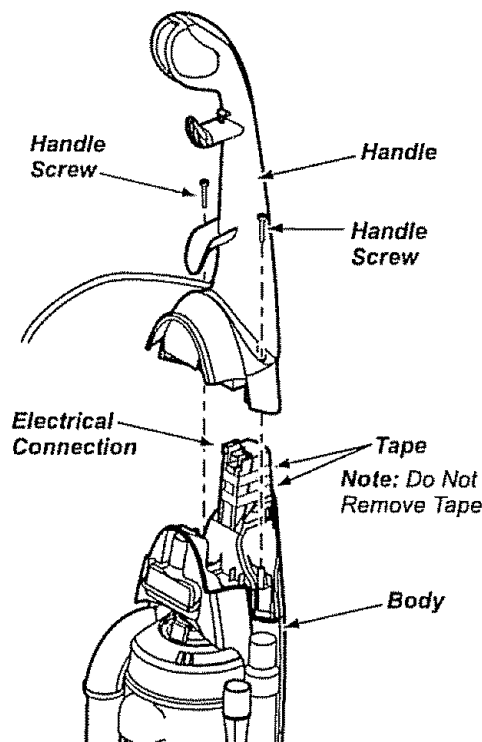

When installing the handle, firmly press the handle onto the body. Secure with handle screws provided.



CAUTION

Do not overtighten.
Overtightening could strip the screw holes.
Do not operate the cleaner without the screws in place.

CORD ASSEMBLY

Make sure the quick release upper cord hook is in the upright position. Remove the wire tie from the power cord.

Make sure the power cord is placed into the locking notch on the body as shown. This helps keep the power cord out from under the vacuum cleaner agitator.

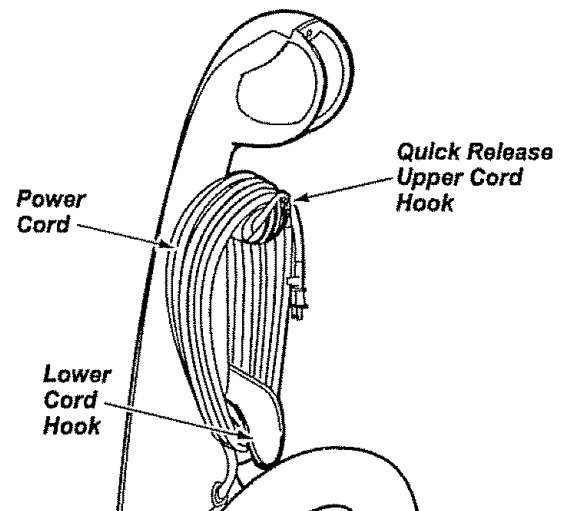
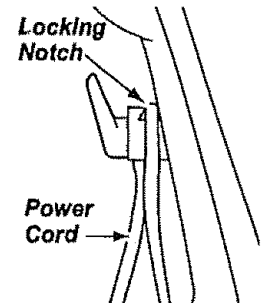

Wrap the power cord around the upper and lower cord hooks and lock the power cord plug onto the power cord.

ENGLISH

EXTENSION HOSE ASSEMBLY

Connect extension hose to the valve assembly by aligning "J" slot with raised tab on valve assembly. Push downward and rotate clockwise to lock in place.

Place the crevice tool in the rectangular slot on back of wand holder.

Connect extension hose to telescopic wand by aligning "J" slot with raised tab on wand. Push hose downward and rotate clockwise to lock in place.

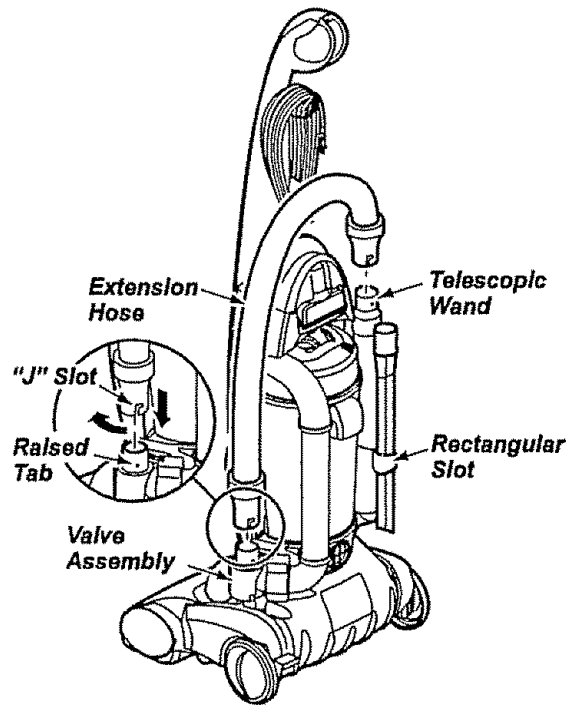

Once extension hose is connected to the telescopic wand, place the wand in the telescopic location as shown.

For use of telescopic wand and extension hose see ATTACHMENTS section on page 9

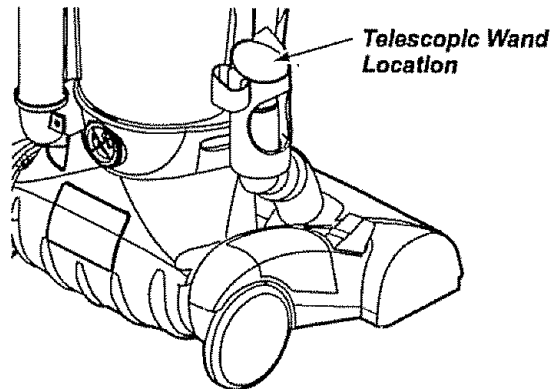

Remove the Handi-Mate Jr.® from the plastic bag and insert Handi-Mate Jr.® into the vacuum cleaner as shown, then close the Handi-Mate Jr.® storage cover.

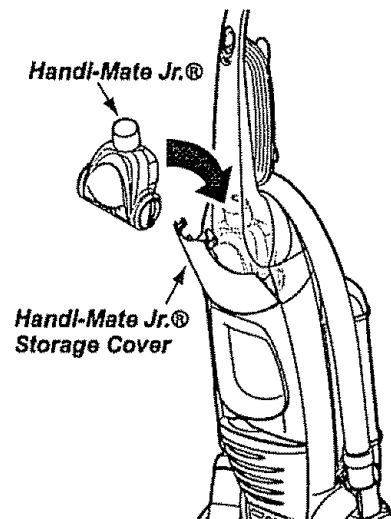

OPERATING INSTRUCTIONS

GETTING STARTED

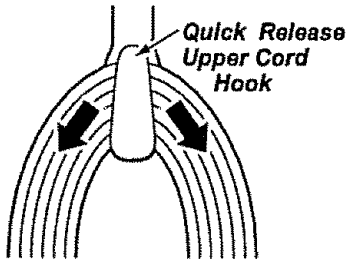

Turn the quick release upper cord hook to either side and down to release the power cord.

Release the power cord plug from the power cord and pull the cord off the quick release upper cord hook. Check to be sure the power cord is still locked into the locking notch in the quick release upper cord hook.

Note: To reduce the risk of electric shock, this vacuum cleaner has a polarized plug, one blade is wider than the other.

This plug will fit in a polarized outlet only one way. If the plug does not fit fully in the outlet, reverse the plug. If it still does not fit, contact a qualified technician to install the proper outlet. Do not change the plug in any way.

Plug the polarized power cord into a 120 Volt outlet located near the floor.



WARNING

Personal Injury and Product Damage Hazard

- DO NOT plug in if switch is in the ON position. Personal injury or damage could result.
- DO NOT use outlets above counters. Damage from cord to items in surrounding area could occur.

ENGLISH

PILE HEIGHT SELECTION AND SETTING

To select a pile height setting:

Turn off cleaner. Select a pile height setting by tilting the cleaner back until front wheels are lifted slightly off the floor as illustrated.

Slide the adjustment lever to the correct setting.

SUGGESTED PILE HEIGHT SETTINGS

You may need to raise the height to make some jobs easier, such as scatter rugs and longer pile carpets. Suggested settings are:

HIGH: shag carpet, long pile, plush, scatter rugs.

MED: medium to long pile.

LOW: short to medium pile.

EX LOW: very low pile and bare floors.

Note: When the pile height selection is set to EX LOW the pull forces will be stronger at the agitator. If the push/pull forces are too aggressive or jerky a higher setting should be used.

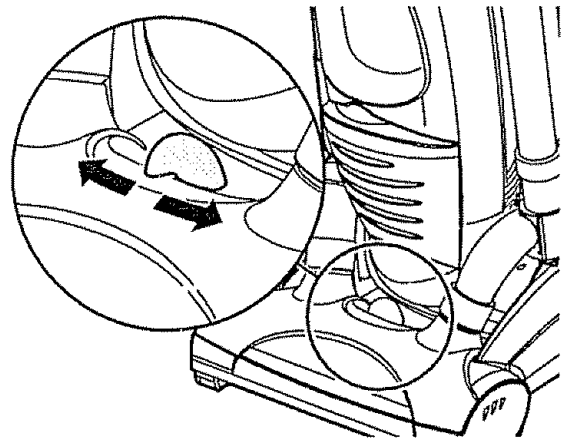

WARNING

Personal Injury Hazard

To avoid personal injury, DO NOT place hands or feet underneath the unit when changing height setting.

ON/OFF SWITCH

HANDLE MOUNTED

To start the vacuum cleaner, slide the ON/OFF switch from the OFF position to the ON position. To stop the vacuum cleaner, slide the switch to the OFF position.

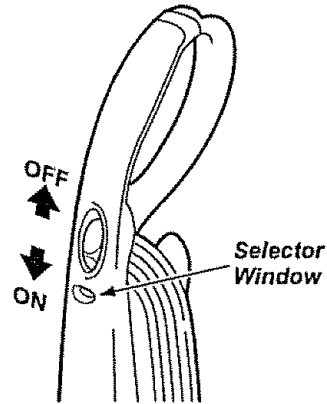

RELEASING THE HANDLE

Release the handle by pressing down on the handle release pedal with your foot and pulling back and down on the handle with your hand.

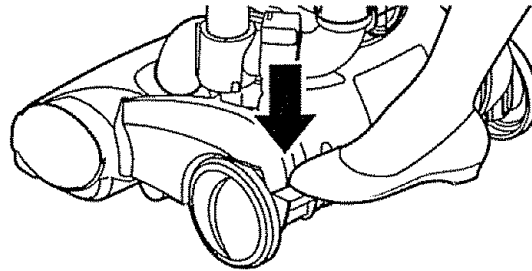

CARPET/BARE FLOOR SELECTOR

The Carpet/Bare Floor selector should be placed in BARE FLOOR position when using cleaner on bare floors and when using tools. When the selector is in the BARE FLOOR position the agitators do not rotate.

The Selector should be placed in CARPET position when using cleaner on carpeted floors.

To operate selector, place cleaner in upright position. Rotate the Carpet-Bare Floor selector to the rear for BARE FLOOR position.

To resume carpet cleaning rotate selector forward to CARPET position

Take care when selecting either position to ensure selector is pushed fully and quickly as possible to desired position

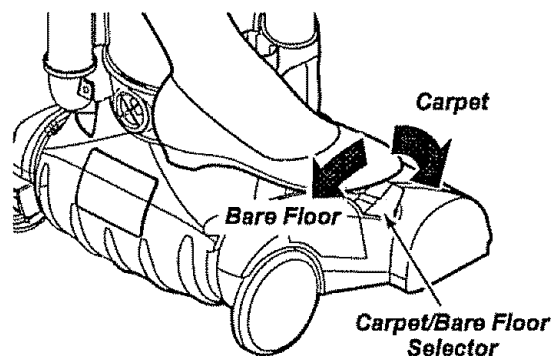

ATTACHMENTS

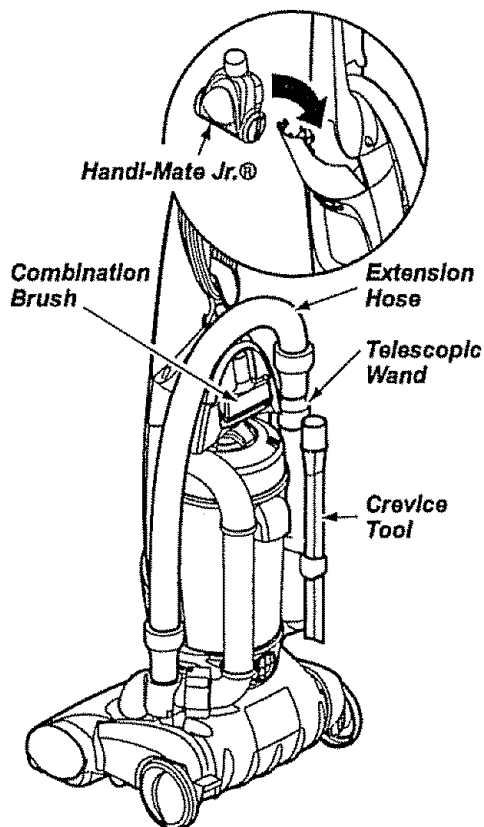

Identify each of the attachments shown above.

Remove the upper end of the hose that is attached to the telescopic wand by grasping the hose collar, twisting and pulling straight out. The attachments can now be added to the hose.

Note: The motor protector may open when using attachments or when cleaning new carpet, due to reduced airflow by the attachments themselves or by new carpet fuzz filling the dust bin quickly. See the TROUBLESHOOTING section.

Note: When using attachments make sure the cleaner is in the upright position and the Carpet/Bare Floor selector is in the Bare Floor position.

WARNING

Electrical Shock And Personal Injury Hazard

Disconnect electrical supply before servicing or cleaning the unit. Failure to do so could result in electrical shock or personal injury from cleaner suddenly starting.

TELESCOPING WAND WITH SUCTION CONTROL SLIDE

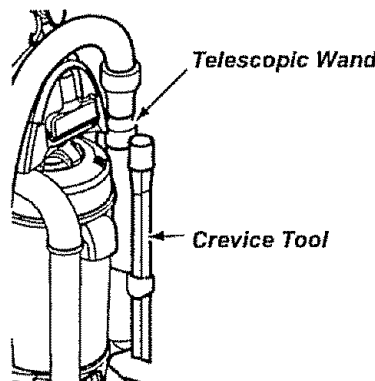

Remove the telescopic wand from its storage position by twisting and pulling out.

ENGLISH

On the telescopic wand turn the locking ring clockwise to the **UNLOCK** position.

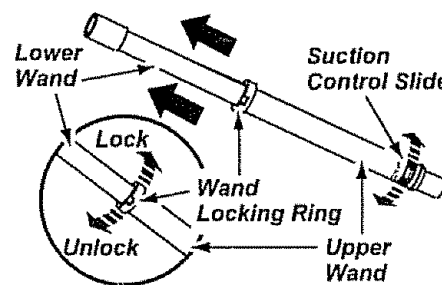

Extend the wand to its full length. Turn the locking ring counter-clockwise to the **LOCK** position. Attach the extension wand onto the open end of the hose.

Remove the crevice tool from its storage position on the wand holder. Attach crevice tool to the extension wand.



CAUTION

When using attachments, be careful not to overextend the stretch hose when reaching. Trying to reach beyond the hose stretch capability could cause the cleaner to tip over..

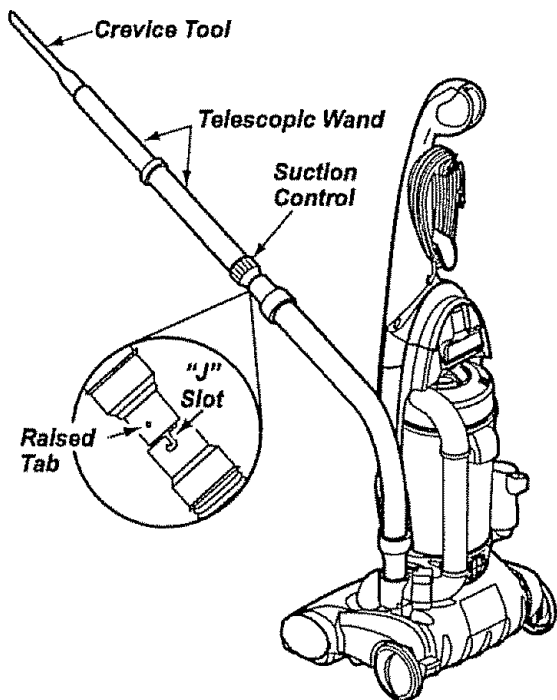

To achieve maximum reach with the attachments, add the crevice tool to the end of the wand by inserting and twisting slightly.

TO OPERATE SUCTION CONTROL SLIDE

When using attachments for cleaning draperies, small rugs with low pile and other delicate items, twist the suction control slide to the open position. This will reduce suction for ease of cleaning.

The slide is located on the telescoping wand, close to the hose.

Note: Return suction control slide to the closed position for normal cleaning.

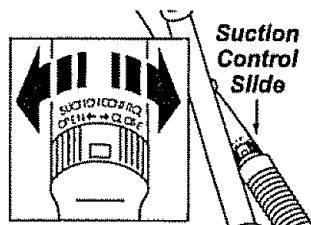

If cleaner has poor cleaning performance, check to make sure the suction control slide is closed.

Handi-Mate Jr.®

For operation of Handi-Mate Jr.® see separate owners manual

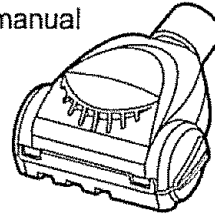

TO STORE ATTACHMENTS

Remove combination brush from wand, hose or crevice tool. Snap into appropriate storage location.

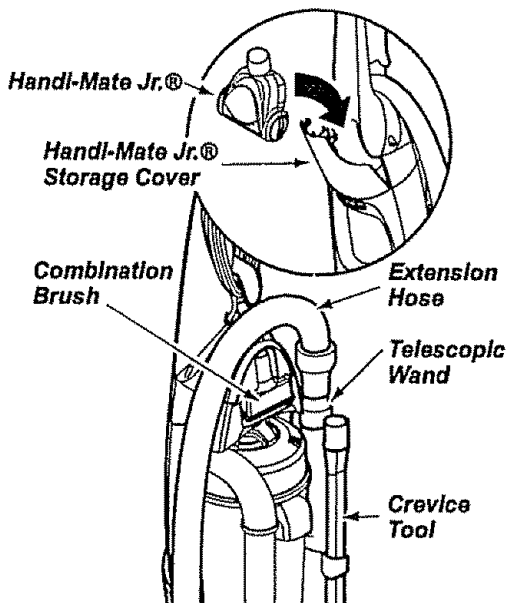

Remove crevice tool from the wand by twisting. Place in wand holder.

Unlock the wand by turning the wand locking ring to the **UNLOCK** position.

Slide the lower wand into the upper wand. Turn the wand locking ring to the **LOCK** position.

Reinsert the extension hose and telescopic wand firmly into wand holder.

Reinsert Handi-Mate Jr.® into the vacuum cleaner as shown then close the Handi-Mate Jr.® storage cover.

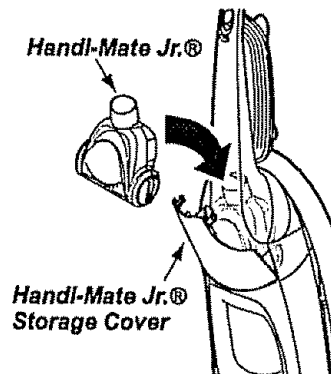

BONUS HOSE

Insert the two tabs on the end of the extension hose into the two "J" shaped slots on the unit hose and twist to connect.

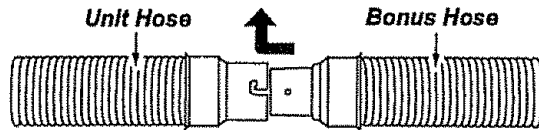



All attachments and the telescoping wand can be attached to the open end of the hose.



WARNING

When using the extension hose or with the bonus hose attached, the cleaner should be on a solid surface on the same level or below the level of the user's feet. **DO NOT** use the hoses when the cleaner is above the level of the user's feet.

ATTACHMENT USE CHART

ATTACHMENT	CLEANING AREA				
	Furniture*	Between Cushions*	Drapes*	Stairs	Walls
CREVICE TOOL 	X	X		X	
COMBINATION BRUSH 	X		X	X	X
Handi-Mate Jr.® 	X			X	

*Always clean attachments before using on fabrics.

VACUUMING TIPS

Carpet edges

Guide either side or the front of the nozzle along a baseboard. The full width agitator brushes help remove dirt at carpet edges.

Stairs

Put handle in full upright position. Place pile height adjustment to HIGH when using attachments to prevent possible floor damage. Use the crevice tool or combo brush.

Note: When using attachments make sure the cleaner is in the upright position and the Carpet/Bare Floor selector is in the Bare Floor position.

For best cleaning results, keep the airflow passage clear.

Occasionally, check each of the areas indicated for clogs. (see page 18)



CAUTION

Unplug the cleaner from the outlet before checking.



WARNING

Personal Injury Hazard

Do not place cleaner on stairs. If it falls, personal injury or property damage could result.

ENGLISH

PERFORMANCE FEATURES

MOTOR PROTECTOR

This vacuum has a motor protector by-pass valve which automatically opens to provide cooling air to the motor when a clog prevents the normal flow of air to the motor. If the by-pass valve opens to prevent motor overheating and possible damage to the vacuum, you will notice a change of sound as air rushes through the valve opening.

Note: Do not block motor protector.

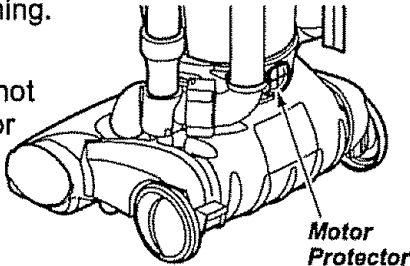

To correct problem: See the TROUBLE-SHOOTING chart.

Note: The motor protector may open when using attachments or when cleaning new carpet, due to reduced airflow by the attachments themselves or by new carpet fuzz filling the dust bin quickly. See the TROUBLESHOOTING section.

THERMAL PROTECTOR

This vacuum has a thermal protector which automatically trips to protect the vacuum from overheating. The thermal protector turns the motor off automatically to allow the motor to cool in order to prevent possible damage to the vacuum.

To reset: Turn off and unplug the vacuum from the outlet to allow the vacuum to cool. **Check for and remove any clogs. Also check and replace any clogged filters. Wait approximately 30 minutes and plug the vacuum in and turn back on to see if the thermal protector has reset. In some cases, the unit may suddenly restart. DO NOT leave unattended.**

PERFORMANCE INDICATOR

When the unit is running with normal air flow, the light on the performance indicator is off.

The light comes on whenever the airflow becomes blocked. If that occurs, check the dust bin, clean/replace clogged filters, and check other possible clog locations shown in CLOG REMOVAL (see page 18).

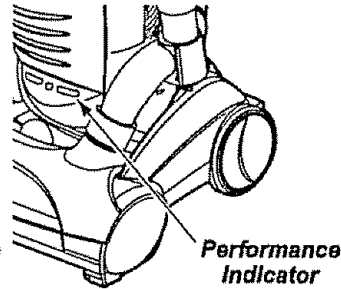

To correct problem: See the TROUBLE-SHOOTING chart.

Note: The light may also come on when using attachments, due to reduced airflow through the attachment.

Note: In some cases, the performance indicator light may not come on if the motor protector has opened.

DIRT SENSOR

The electronic dirt sensor is a feature which will detect particles as they pass through the vacuum cleaner.

The dirt sensor indicators and sensor sensitivity switch are located on the front of the switch cover.

A red light indicates dirt is being picked up by the cleaner. A green light indicates most of the dirt has been picked up by the cleaner.

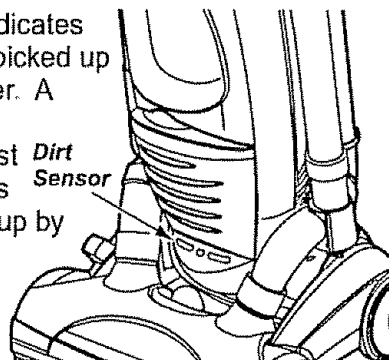

OPERATION

As you vacuum, the red indicator light will come on and stay on as long as the sensor detects a high concentration of particles passing through the cleaner.

The green light indicates that most of the cleaning is complete.

The sensor switch allows you to select the sensitivity of the dirt sensor. The switch can be set to HI (+) or LO (-) sensitivity.

Set the sensor switch to the HI (+) position when:

- Cleaning bare floors.
- Cleaning carpet with low pile height.

Set the sensor switch to the LO (-) position when:

- Cleaning heavily soiled areas.
- Cleaning carpet with deep pile.
- Cleaning new carpets.

Even with the sensor switch in the LO (-) position, the dirt sensor will detect carpet fuzz, especially on new carpet, which may cause the red light to remain on longer than expected.

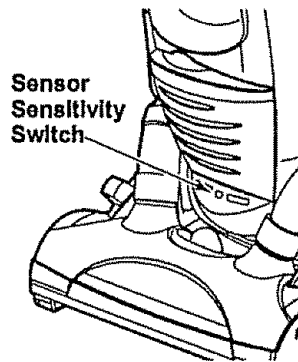

TO CLEAN DIRT SENSOR OPTICS

The dirt sensor optics consist of two optic cells located inside the valve assembly. Occasionally, it may become necessary to clean the two optic cells to assure maximum performance. Clean optic cells:

- When the red light stays on continuously.
- When the green light stays on continuously.
- When dirt or dust adheres to the optic cells.
- Whenever the dust cup is cleaned.

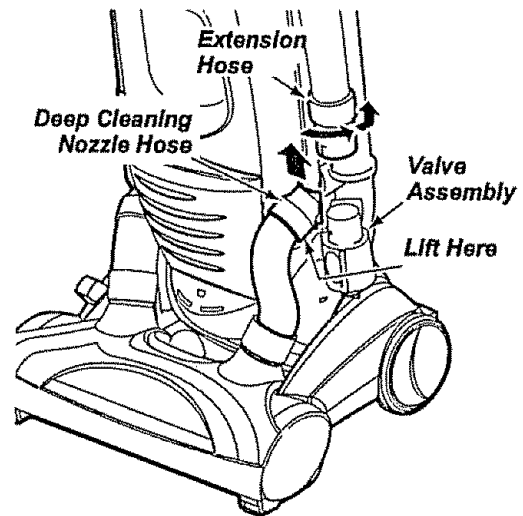

To clean the sensor, remove deep cleaning nozzle hose at valve assembly by lifting hose straight up. Remove extension hose from the valve assembly by grasping hose collar, twisting, and pulling straight off.

Lay cleaner back by pressing the handle release pedal. (see Releasing the Handle page 8).

With the hoses removed you can insert a cloth into the valve opening.

Wipe the optic cells with a soft, dry cloth.

Never use cleaners or liquids as they can help speed the recoating of the optic cells and make it necessary to clean them much sooner than normal.

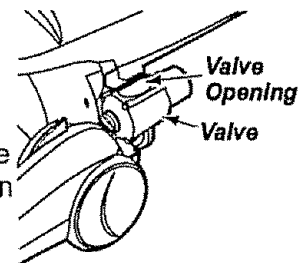

Return cleaner to the upright position. Re-attach nozzle hose and extension hose.



WARNING

Electrical Shock And Personal Injury Hazard

Disconnect electrical supply before servicing or cleaning the unit. Failure to do so could result in electrical shock or personal injury from cleaner suddenly starting.

VACUUM CLEANER CARE

Always follow all safety precautions when cleaning and servicing the vacuum cleaner.



WARNING

Electrical Shock And Personal Injury Hazard

Disconnect electrical supply before servicing or cleaning the unit. Failure to do so could result in electrical shock or personal injury from cleaner suddenly starting.

VACUUM STORAGE

Gather the cord and wrap it loosely around the upper and lower cord hooks.

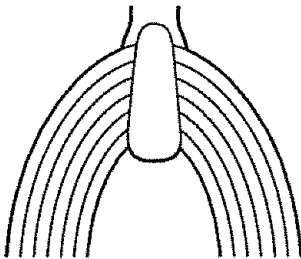

Store the cleaner in a dry, indoor area, on the floor with the handle locked in the upright position.



WARNING

Electrical Shock And Personal Injury Hazard

Wrapping the cord too tightly puts stress on the cord and can cause cord damage. A damaged cord is an electrical shock hazard and could cause personal injury or damage.

CLEANING EXTERIOR AND ATTACHMENTS

Unplug cord from wall outlet.

Clean exterior using a clean, soft cloth that has been dipped in a solution of mild liquid detergent and water, then wrung dry. Wipe dry after cleaning. **DO NOT** drip water on cleaner.

Wash attachments in warm soapy water, rinse and air dry. **Do not clean in dishwasher.**



CAUTION

Do not use attachments if they are wet. Attachments used in dirty areas, such as under a refrigerator, should not be used on other surfaces until they are washed. They could leave marks.

DUST BIN CLEANING

Always empty the dust bin when dirt level reaches the "MAXIMUM FILL" line.

TO REMOVE DUST BIN



WARNING

Electrical Shock And Personal Injury Hazard

Always unplug power cord from electrical outlet before performing any service on vacuum.

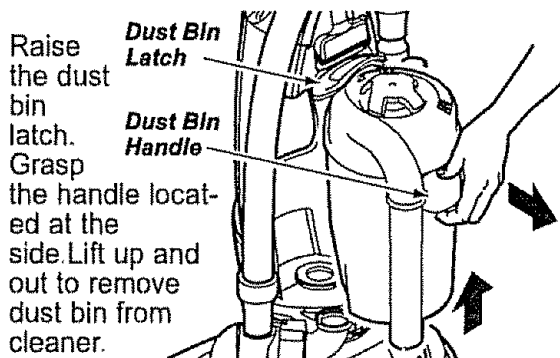

Remove any clogs that might be located in the dust bin port or the filter screen.

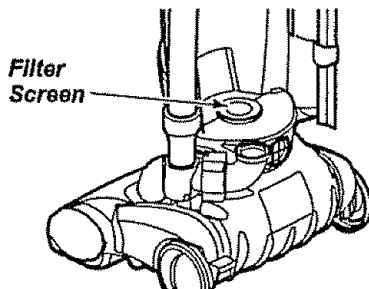

CAUTION

Do not use dust bin handle to carry unit.

Do not carry dust bin by dust bin lid.

Every time dust bin is removed, rotate cleaning knob on top of dust bin until filter is clean to maintain cleaning performance.



TO EMPTY DUST CUP

Hold dust bin over a trash container. Lift dust bin lid directly off the dust cup.

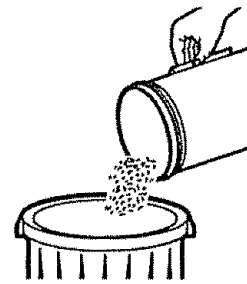
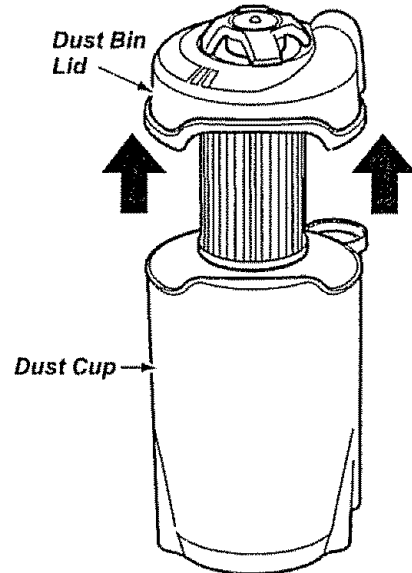

Pour dust cup contents into a trash container.

TO CLEAN FILTER

See Filter Changing/Cleaning page 17

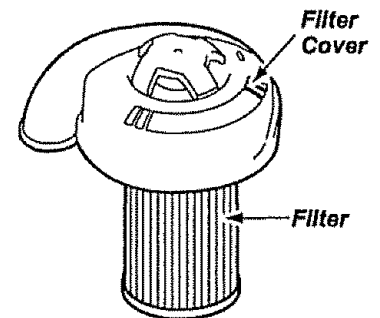

ENGLISH

TO REPLACE DUST BIN

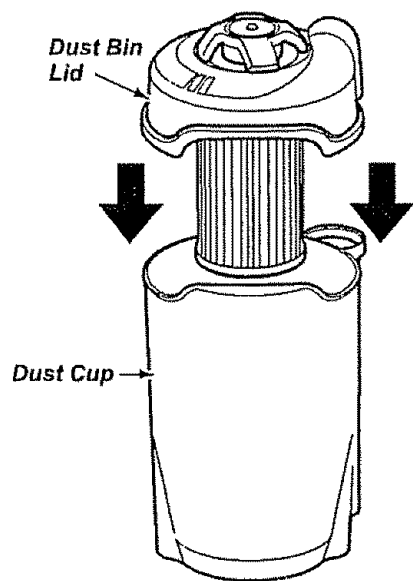

Replace dust bin lid assembly by placing back on dust cup as shown.

Place dust bin into vacuum cleaner

Secure dust bin into place by closing the dust bin latch.

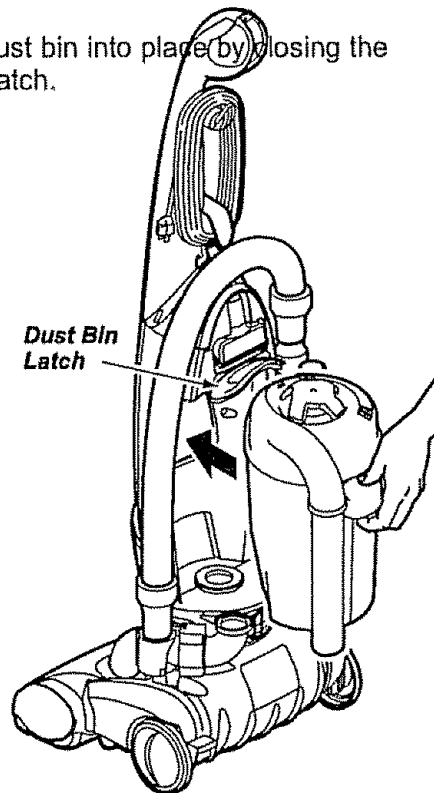

FILTER SCREEN CLEANING

Remove the dust bin as outlined in the DUST BIN CLEANING section.

Check filter screen frequently and clean when dirty.

To clean filter screen, wipe screen with a dry cloth.

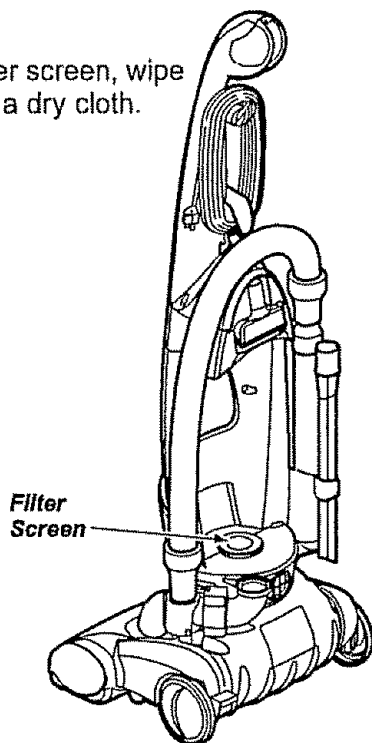

FILTER CHANGING/CLEANING



WARNING

Electrical Shock Hazard
Unplug power cord from electrical outlet. Do not operate the cleaner without the primary or exhaust filters. Be sure the filters are properly installed to prevent motor failure and/or electrical shock.

PRIMARY FILTER

Check primary filter frequently and clean when dirty.

TO REMOVE PRIMARY FILTER

Remove the dust bin and dust bin lid assembly as outlined in the DUST BIN CLEANING section.

While holding primary filter over a trash container grasp filter, rotate and lift off.

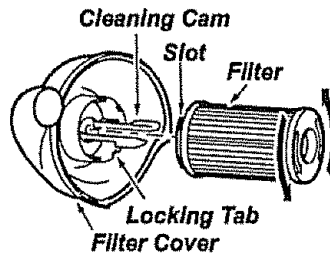

Clean primary filter by gently tapping over a trash container. Tap on several sides to ensure best cleaning. **Rinse with water only as needed, do not use any detergent or soap.** Allow the filter to dry for 24 hours before putting it back into the vacuum.

When cleaning the filter no longer restores vacuum suction to full power you need to replace the filter.

TO REPLACE PRIMARY FILTER

With slot side on filter towards the filter cover slide cleaning cam inside opening, rotate filter clockwise until slots lock onto tabs in cover.

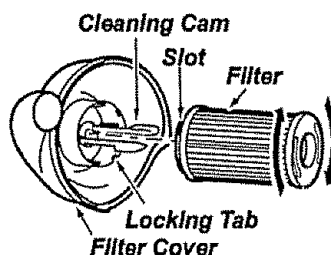

Note: Under normal use and care, your filter can be expected to last up to 5 years.

Re-assemble dust bin lid to dust bin. Insert into cleaner and secure with dust bin latch.

EXHAUST FILTER

HEPA

The exhaust filter must be replaced when dirty. It should be replaced regularly depending on use conditions.

The filter **CANNOT** be washed as it will lose its dust trapping ability.

Note: See PARTS AND FEATURES for the exhaust filter number.

Remove filter cover by pulling out at the top of the exhaust filter cover.

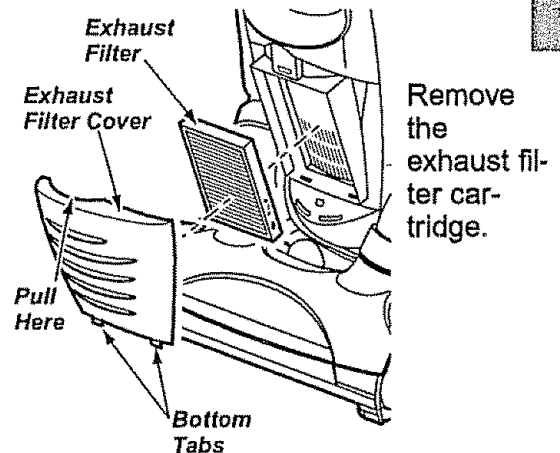

Push only on filter cartridge frame, not on filter material itself.

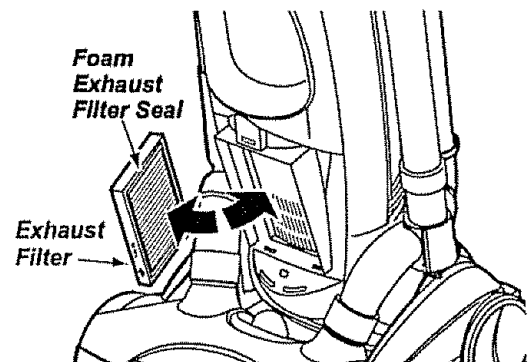

The foam seal of the filter should be placed against the vacuum cleaner body

Replace the exhaust filter cover by placing bottom tabs in slots and pushing in until cover snaps into place.

ENGLISH

CLOG REMOVAL

Always follow all safety precautions when cleaning and servicing the vacuum cleaner.



WARNING

Electrical Shock Or Personal Injury Hazard

Disconnect electrical supply before servicing or cleaning the unit. Failure to do so could result in electrical shock or personal injury from cleaner suddenly starting.

If the cleaner does not seem to have adequate suction, first check if the dust bin is full or if a filter is clogged. See DUST BIN CLEANING and FILTER CHANGING.

If the dust bin and filter areas are free of clogs, check the hose area. Remove extension hose from the valve assembly by grasping the hose collar, twisting, and pulling straight off.

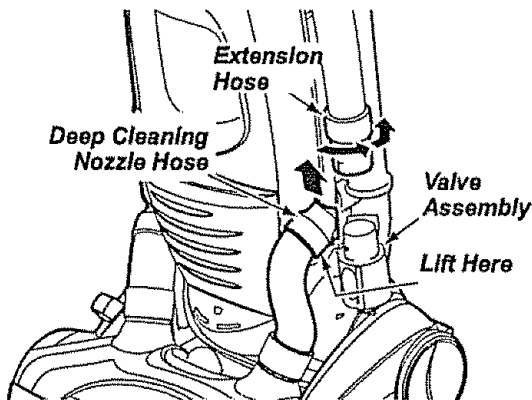

Visually inspect the hose and the base area into which the hose is connected.

Remove any visible clog.

Re-connect the extension hose to the valve assembly. Plug in the vacuum and turn it on. Stretch the hose to maximum length and then allow the hose to return to its storage length.

Turn the unit off and unplug the unit.

Remove dust bin and check dust bin port and secondary screen for clogs. If the dust bin and filter areas and the hose areas are free of clogs, check the nozzle area. To check this area, see the section on AGITATOR CLEANING.

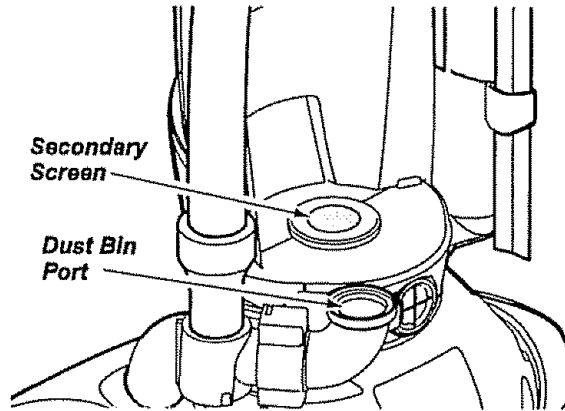

Return the cleaner to the upright position before plugging into an electrical outlet.



WARNING

Personal Injury Hazard

DO NOT place hands or feet underneath the unit at any time. The agitator will be revolving rapidly when the vacuum is turned on and is in the carpet setting.

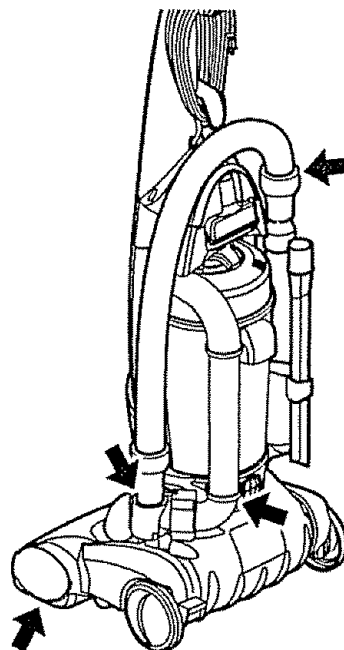

LIGHT BULB CHANGING



WARNING

Electrical Shock Or Personal Injury Hazard

Disconnect electrical supply before servicing or cleaning the unit. Failure to do so could result in electrical shock or personal injury from cleaner suddenly starting.

TO REMOVE LIGHT BULB

Disconnect power cord from electrical outlet. Lower handle to lay vacuum flat.

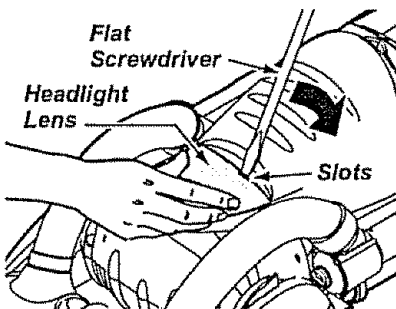

Pry out light lens at slots.



CAUTION

Do not use a bulb rated over 9W (13V). During extended use, heat from the bulb could overheat surrounding plastic parts.

Remove the light bulb by pulling straight out.

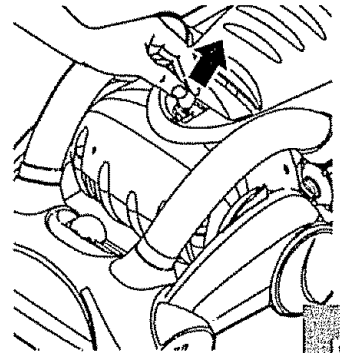

To replace the light bulb carefully insert securely into slot.

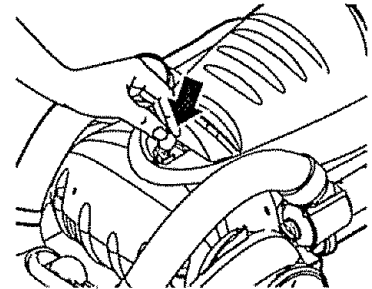

ENGLISH

Replace lens cover by inserting bottom tab of lens into slot then applying pressure to top tabs with a screwdriver. A "popping" sound indicates lens is snapped properly in place.

Note: See PARTS AND FEATURES for bulb number.



CAUTION

Do not plug in or turn on until the vacuum is completely reassembled.

AGITATOR CLEANING



WARNING

Electrical Shock Or Personal Injury Hazard

Disconnect electrical supply before servicing or cleaning the unit. Failure to do so could result in electrical shock or personal injury from cleaner or agitator suddenly starting.

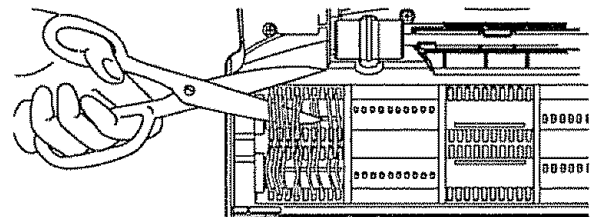

To clean agitator turn vacuum over, cut off any carpet pile and lint entangled around agitator with a pair of scissors in the slots provided. Remove hair, string, lint and other debris from the agitator.

VALVE CLEANING

The valve assembly will be closed when the cleaner is in the upright position. When you release the handle for normal operation the valve opens to allow air to pass for normal deep cleaning. This valve will sometimes become dirty and may need routine cleaning.

To clean the valve you must first remove the deep cleaning nozzle hose to gain access to the valve. Once the hose is removed, wipe the surface of the valve.

Release the handle (see Handle Release section, page 8) and lay cleaner back.

With the cleaner in the back position the valve is open. Wipe the inside with a soft cloth to remove any dirt or residue.

Return cleaner to the upright position. Re-attach nozzle hose and extension hose.

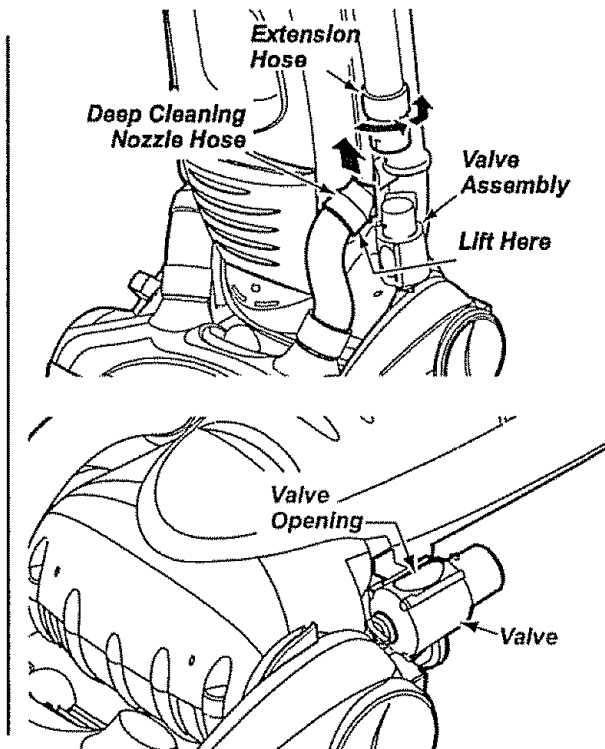

REPLACING BELT



WARNING

Electrical Shock And Personal Injury Hazard

Disconnect electrical supply before servicing or cleaning the unit. Failure to do so could result in electrical shock or personal injury from cleaner suddenly starting.

Replace belt whenever a burning rubber smell caused by excessive slippage occurs.



CAUTION

BELT AND MOTOR SHAFT
MAY BE HOT!

Make sure the vacuum has completely cooled prior to replacing belt.

To remove the belt cover, depress the tab and lift off. Remove worn or broken belt.

Place CARPET/FLOOR selector in the BARE FLOOR position.

Loop new belt around the motor shaft. Hold the inside of the belt against the top of the large pulley and rotate the pulley clockwise until the belt is completely on the pulley.

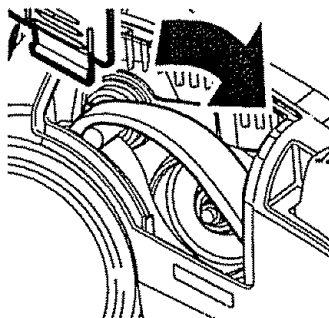

Note: See PARTS AND FEATURES for belt number.

Rotate the pulley and the motor shaft to ensure that belt is not twisted or pinched.

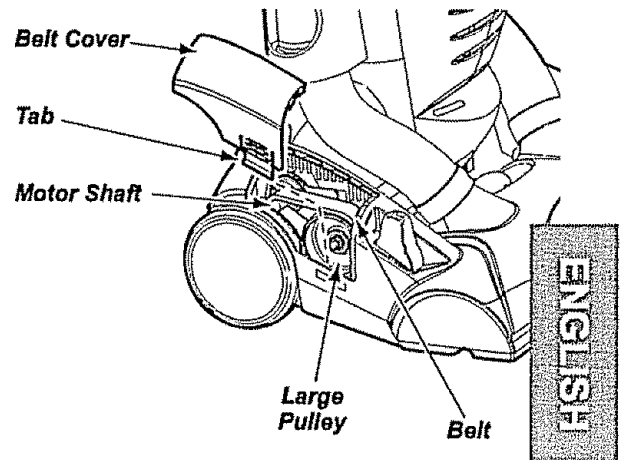

Reinstall belt cover and securely snap into place.

DO NOT operate cleaner without belt cover in place.

TROUBLESHOOTING

Review this table to find do-it-yourself solutions for minor performance problems. Any service needed, other than those described in this owner's manual, should be performed by a Sears service representative.



WARNING Electrical Shock Hazard

Disconnect electrical supply before servicing or cleaning the unit. Failure to do so could result in electrical shock or personal injury.

PROBLEM	POSSIBLE CAUSE	POSSIBLE SOLUTION
Cleaner won't run.	<ol style="list-style-type: none"> 1. Unplugged at wall outlet 2. Tripped circuit breaker/blown fuse at household service panel. 	<ol style="list-style-type: none"> 1. Plug in firmly, push ON/Off switch to ON. 2. Reset circuit breaker or replace fuse.
Poor job of dirt pick-up.	<ol style="list-style-type: none"> 1. Full or clogged dust bin. 2. Wrong pile height setting. 3. Worn agitators. 4. Clogged nozzle. 5. Clogged hose. 6. Hole in hose 7. Hose not inserted fully 8. Motor protection system activated. 9. Dirty filters. 10. Suction control slide open 11. Broken or worn belt 	<ol style="list-style-type: none"> 1. Empty dust bin,, (page 15) 2. Adjust setting, (page 7). 3. Take to your nearest Sears Service Center. 4. Check CLOG REMOVAL, (page 18) 5. Check for clogs, (page 18). 6. Take to your nearest Sears Service Center. 7. Check hose connection 8. Check for clogs, (page 18) 9. Change filters, (page 17). 10. Close slide (page 10). 11. Replace belt (page 20).
Cleaner picks up moveable rugs or pushes too hard.	<ol style="list-style-type: none"> 1. Wrong pile height setting. 	<ol style="list-style-type: none"> 1. Adjust setting, (page 7).
Light won't work.	<ol style="list-style-type: none"> 1. Burned out light bulb. 	<ol style="list-style-type: none"> 1. Change light bulb, (page 19).
Performance indicator is red.	<ol style="list-style-type: none"> 1. Full or clogged dust bin. 2. Dirty filters. 3. Clogged airflow passage. 4. Certain attachment tools. 	<ol style="list-style-type: none"> 1. Empty dust bin, (page 15). 2. Change filters, (page 17). 3. Clear clog from airflow passage, (page 18). 4. This is normal. Light should go off when tool is removed.
Air flow restricted with attachment use. Sound changes.	<ol style="list-style-type: none"> 1. Attachment use restricts air flow. 2. New carpet fuzz clogged air path. 	<ol style="list-style-type: none"> 1. Check ATTACHMENTS, (page 9) 2. Check CLOG REMOVAL and clean hose, (page 18)
Dirt Sensor, some models, will not work.	<ol style="list-style-type: none"> 1. Dirty optic cells. 	<ol style="list-style-type: none"> 1. Clean optic cells, (page 13)

Get it fixed, at your home or ours!

Your Home

For repair – in your home – of all major brand appliances, lawn and garden equipment, or heating and cooling systems, **no matter who made it, no matter who sold it!**

For the replacement parts, accessories and owner's manuals that you need to do-it-yourself.

For Sears professional installation of home appliances and items like garage door openers and water heaters.

1-800-4-MY-HOMESM Anytime, day or night
(1-800-469-4663) (U.S.A. and Canada)
www.sears.com www.sears.ca

Our Home

For repair of carry-in products like vacuums, lawn equipment, and electronics, call or go on-line for the nearest **Sears Parts and Repair Center.**

1-800-488-1222 Anytime, day or night (U.S.A. only)
www.sears.com

To purchase a protection agreement (U.S.A.) or maintenance agreement (Canada) on a product serviced by Sears:

1-800-827-6655 (U.S.A.) **1-800-361-6665** (Canada)

Para pedir servicio de reparación a domicilio, y para ordenar piezas:

1-888-SU-HOGARSM
(1-888-784-6427)

Au Canada pour service en français:

1-800-LE-FOYER^{MC}
(1-800-533-6937)
www.sears.ca

SEARS

©Sears, Roebuck and Co.

® Registered Trademark / TM Trademark / SM Service Mark of Sears, Roebuck and Co.

® Marca Registrada / TM Marca de Fábrica / SM Marca de Servicio de Sears, Roebuck and Co.

^{MC} Marque de commerce / ^{MD} Marque déposée de Sears, Roebuck and Co.

Free Manuals Download Website

<http://myh66.com>

<http://usermanuals.us>

<http://www.somanuals.com>

<http://www.4manuals.cc>

<http://www.manual-lib.com>

<http://www.404manual.com>

<http://www.luxmanual.com>

<http://aubethermostatmanual.com>

Golf course search by state

<http://golfingnear.com>

Email search by domain

<http://emailbydomain.com>

Auto manuals search

<http://auto.somanuals.com>

TV manuals search

<http://tv.somanuals.com>