

Owner's Manual
Manual Del Propietario

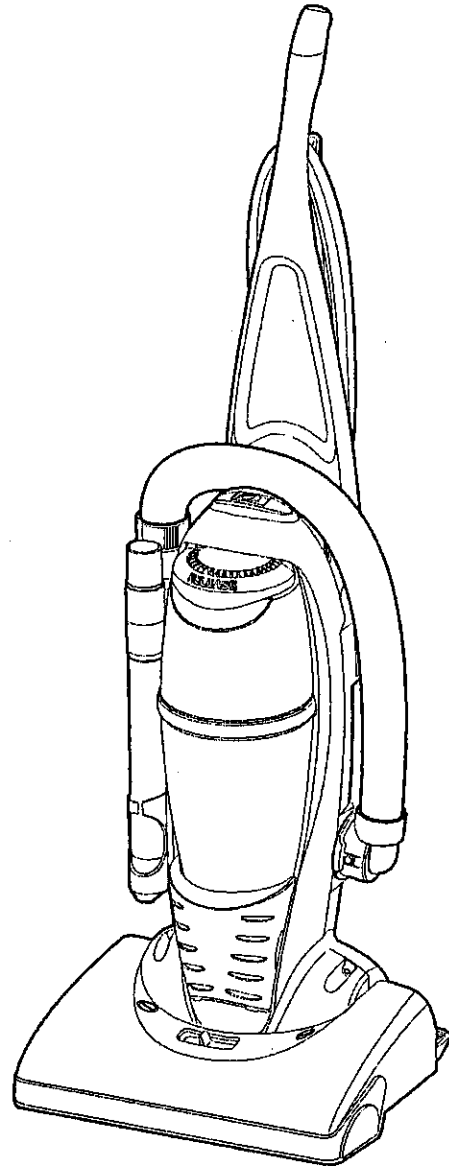

Vacuum Cleaner
Aspiradora

Model , Modelo 116.34722
116.34723



ENGLISH

ESPAÑOL

CAUTION:

Read and follow all safety and operating instructions before first use of this product.

CUIDADO:

Lea y siga todas las instrucciones de operación y seguridad antes del uso de este producto.

Sears, Roebuck and Co., Hoffman Estates, IL 60179 U.S.A.
www.sears.com

Part No. CØ1ZCGY1ØUØØ - KCØ1ZCGYZØUØ

Impreso en Mexico

Printed in Mexico

TABLE OF CONTENTS

Before Using Your New Vacuum	2	Vacuum Cleaner Care	9
Kenmore Vacuum Cleaner Warranty	2	Vacuum Storage	9
Important Safety Instructions	3	Cleaning Exterior and Attachments	9
Parts and Features	4	Dust Bin Cleaning	10
Operating Instructions	5	Dust Bin Assembly	11
Getting Started	5	Dust Bin Filter Changing/Cleaning	12
Using Handle	5	Filter Replacement	13
Storing Handle	5	Cleaning Secondary Filter Screen	13
Cord Assembly	5	Exhaust Filter Cleaning	13
Using Cord Hook	5	Replacing Headlight Bulb	14
Pile Height Selection and Settings	6	Belt Changing and Agitator Cleaning	15,16
On/Off Switch	6	Cleaning Exterior	17
Releasing the Handle	6	Removing Clogs	17
Attachments	7		
Attachment Use Chart	7	Troubleshooting	18
Vacuuming Tips	8	Requesting service	(back page)
Performance Features	8		

BEFORE USING YOUR NEW VACUUM

Please read this guide. It will help you assemble and operate your new Kenmore vacuum in the safest and most effective way.

For more information about vacuum cleaner care and operation, call your nearest Sears store. You will need the complete model and serial numbers when requesting information. Your vacuum's model and serial numbers are located on the Model and Serial Number Plate.

Use the space below to record the model number and serial number of your new Kenmore vacuum.

Model No. _____

Serial No. _____

Date of Purchase _____

Keep this book and your sales check (receipt) in a safe place for future reference.

KENMORE VACUUM CLEANER WARRANTY

LIMITED ONE YEAR WARRANTY ON KENMORE VACUUM CLEANER

This warranty is for one year from the date of purchase, and includes only private household vacuum cleaner use. During the warranty year, when this vacuum cleaner is operated and maintained according to the owner's manual instructions, Sears will repair any defects in material or workmanship free of charge.

This warranty excludes vacuum bags, belts, light bulbs, and filters, which are expendable parts and become worn during normal use.

For warranty service, return this vacuum cleaner to the nearest Sears Service Center in the United States.

This warranty applies only while this product is in use in the United States. This warranty gives you specific legal rights, and you may also have other rights which vary from state to state.

Sears, Roebuck and Co., D/817 WA, Hoffman Estates, IL 60179

IMPORTANT SAFETY INSTRUCTIONS



WARNING

Your safety is important to us. To reduce the risk of fire, electrical shock, injury to persons or damage when using your vacuum cleaner, follow basic safety precautions including the following:

Read this manual before assembling or using your vacuum cleaner.

Use your cleaner only as described in this manual. Use only with Sears recommended attachments.

To reduce the risk of electrical shock – **Do not** use outdoors or on wet surfaces.

Disconnect electrical supply before any servicing or cleaning. Failure to do so could result in electrical shock or personal injury.

Always turn cleaner off before unplugging.

Do not unplug by pulling on cord. To unplug, grasp the plug, not the cord.

Do not use with damaged cord or plug. If cleaner is not working as it should, has been dropped, damaged, left outdoors, or dropped into water, return it to a Sears Service Center.

Do not pull or carry by cord, use cord as a handle, close door on cord, or pull cord around sharp edges or corners. Do not run cleaner over cord. Keep cord away from heated surfaces.

Do not leave cleaner when plugged in. Unplug from outlet when not in use and before servicing.

Do not allow to be used as a toy. Close attention is necessary when used by or near children.

Do not handle plug or cleaner with wet hands.

Do not put any objects into openings. **Do not** use with any opening blocked; keep free of dust, lint, hair and anything that may reduce air flow.

Keep hair, loose clothing, fingers, and all parts of body away from openings and moving parts.

Do not use cleaner without dust bin and/or filters in place.

Always clean the dust bin after vacuuming carpet cleaners or freshener, powders and fine dust. These products clog the filters, reduce airflow and can cause damage to the cleaner. Failure to clean the dust bin could cause permanent damage to the cleaner.

Do not use the cleaner to pick up sharp hard objects, small toys, pins, paper clips, etc. They may damage the cleaner or dust bin.

Do not pick up anything that is burning or smoking, such as cigarettes, matches, or hot ashes.

Do not use cleaner to pick up flammable or combustible liquids (gasoline, cleaning fluids, perfumes, etc.), or use in areas where they may be present. The fumes from these substances can create a fire hazard or explosion.

Use extra care when cleaning on stairs. Do not put on chairs, tables, etc. Keep on floor.

You are responsible for making sure that your vacuum cleaner is not used by anyone unable to operate it properly.

SAVE THESE INSTRUCTIONS

Proper assembly and safe use of your vacuum cleaner are your responsibilities. Your cleaner is intended only for household use. Read this Owner's Manual carefully for important use and safety information. This guide contains safety statements under warning and caution symbols. Please pay special attention to these boxes and follow any instructions given. **WARNING** statements alert you to such dangers as fire, electrical shock, burns and personal injury. **CAUTION** statements alert you to such dangers as personal injury and/or property damage.

ENGLISH

PARTS AND FEATURES

Item	Part No. In U.S.	Part No. In Canada
Exhaust Filter	20-86880	20-86880
Headlight Bulb	20-5248	20-5248C
Belt	20-5275	20-5275C

It is important to know your vacuum cleaner's parts and features to assure its proper and safe use. Review these before using your cleaner.

ATTACHMENTS

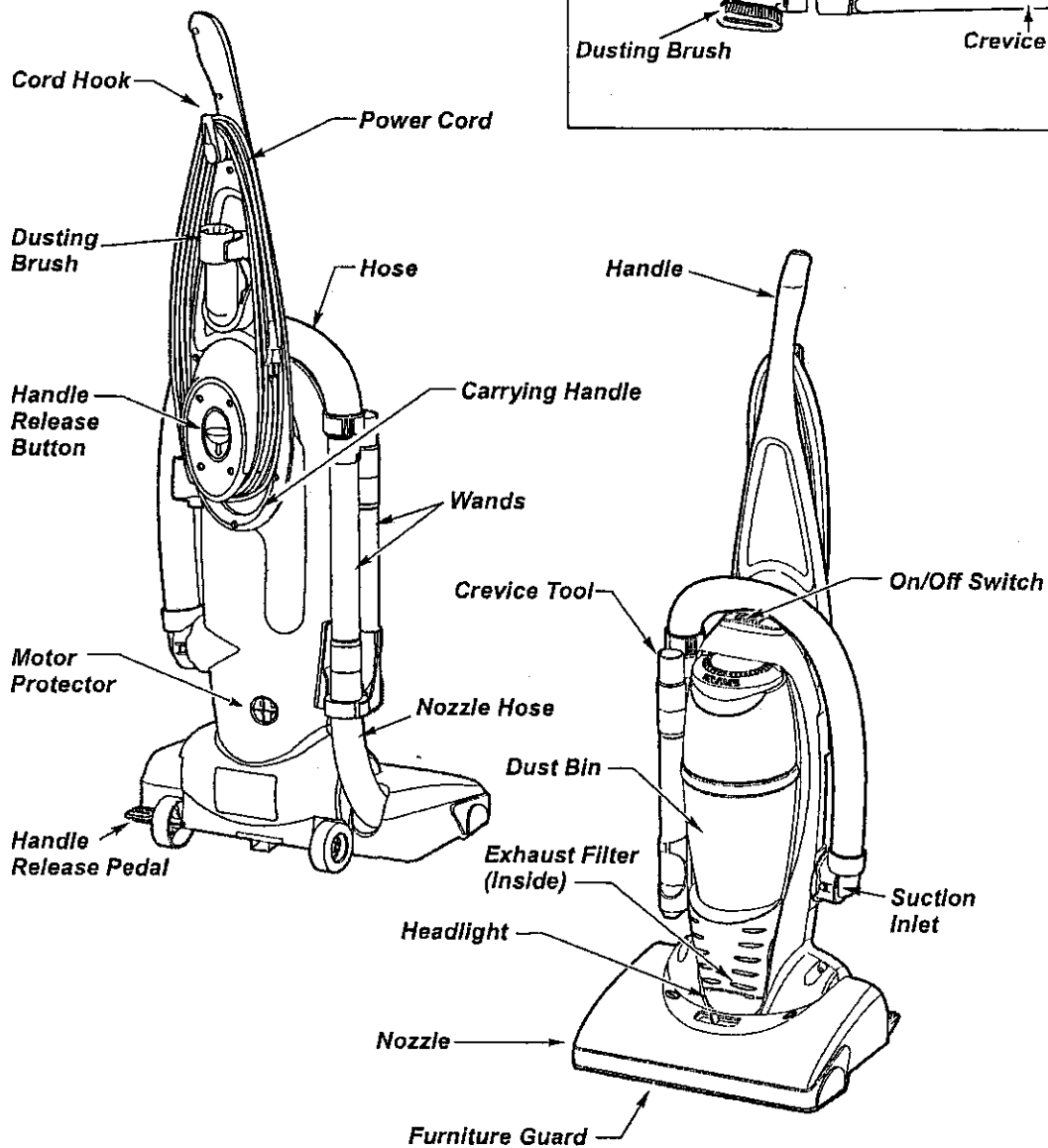
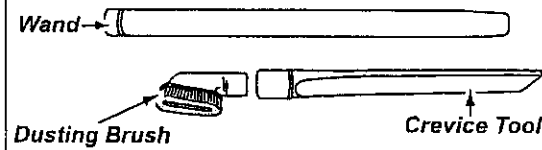

OPERATING INSTRUCTIONS

GETTING STARTED

USING HANDLE

To release handle; press handle release button as shown. With release button depressed rotate handle clockwise to the operating position. Once handle reaches the operating position (up) the handle will automatically lock into place.

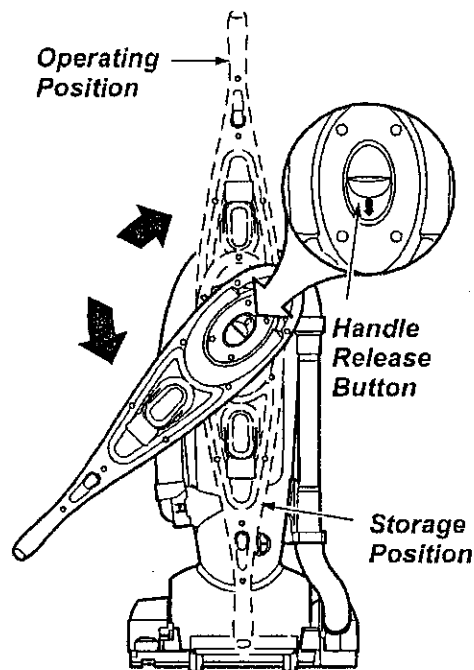

NOTE: You should hear a noticeable "click" sound when handle reaches the operating position.

NOTE: Make sure the handle is locked in the operating position before using vacuum. DO NOT operate vacuum unless handle is locked.

STORING HANDLE

To rotate the handle to the storage position when vacuum is not in use, press handle release button and rotate handle counter-clockwise for easy storage.

NOTE: You should hear a noticeable "click" sound when handle reaches the storage position.

Never pull the vacuum cleaner with the handle in the storage position. The handle will drag on the floor.

Always lift the vacuum by the carrying handle when transporting to storage.

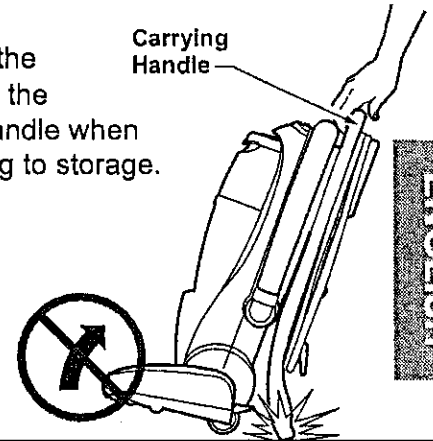

ENGLISH

CORD ASSEMBLY

Make sure the quick release upper cord hook is in the upright position. Remove the wire tie from the power cord.

Make sure the power cord is placed into the locking notch. This helps keep the power cord out from under the vacuum cleaner agitator.

Wrap the power cord around the upper and lower cord hooks and lock the power cord plug onto the power cord.

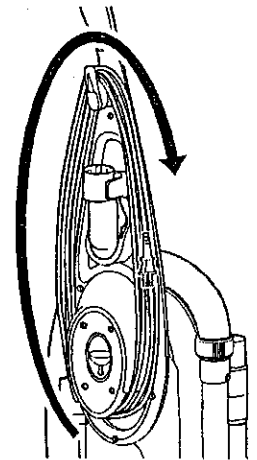

USING CORD HOOK

Detach plug head from power cord.

Rotate cord hook down to release cord. Return the cord hook to the upright position before attempting to rewind the cord.

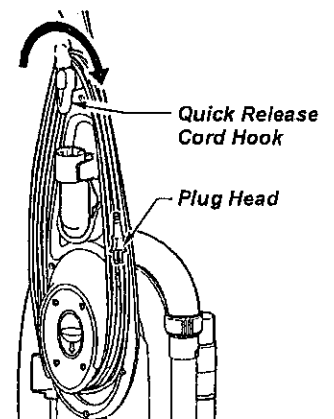

PILE HEIGHT SELECTION AND SETTING

SOME MODELS

To select a pile height setting:

Turn off cleaner. Select a pile height setting by tilting the cleaner back until front wheels are lifted slightly off the floor as illustrated.

Slide the adjustment lever to the correct setting.

Models with no selector adjust automatically for varying carpet heights.

SUGGESTED PILE HEIGHT SETTINGS

You may need to raise the height to make some jobs easier, such as scatter rugs and longer pile carpets.

Suggested settings are:

HIGH: shag carpet, long pile, plush, scatter rugs

MED: medium to long pile.

LOW: short to medium pile.

EX LOW: very low pile.

Place unit in "HIGH" when using attachments to prevent possible floor damage.

ATTENTION: Special care is required when vacuuming certain types of carpet or floor covering. Always check the carpet or floor covering manufacturer's recommended cleaning instructions before vacuuming.

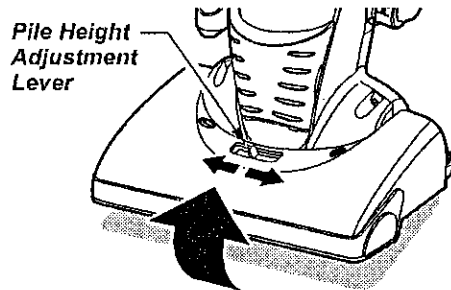

WARNING

Personal Injury Hazard

To avoid personal injury, **DO NOT** place hands or feet underneath the unit when changing height setting.

ON/OFF SWITCH

Ensure ON-OFF switch is OFF. Plug the power cord into 120V outlet. ON position turns vacuum on. OFF position turns vacuum off.

On-Off Switch

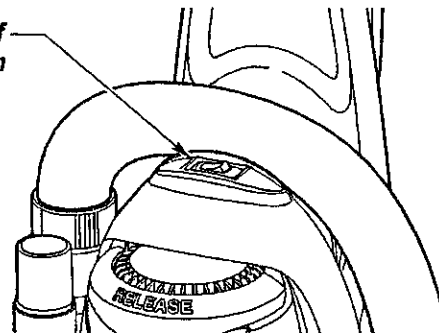

RELEASING THE HANDLE

Release the handle by pressing down on the handle release pedal with your foot and pulling back and down on the handle with your hand.

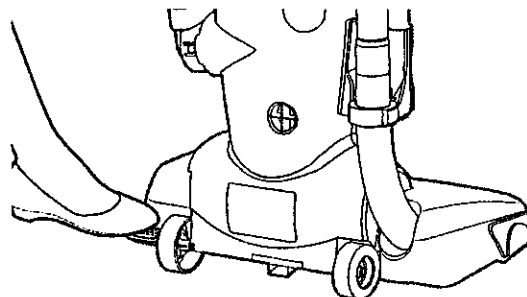

ATTACHMENTS



WARNING

Personal Injury Hazard
DO NOT place hands or feet underneath the unit. When using the attachments, the agitator rotates. Do not allow the cleaner to remain in just one place for a period of time, as the agitator may damage the floor surface. Avoid placing the vacuum on furniture, the fringed area of rugs, deep pile carpeting, or carpeted stairs. The ideal position for the cleaner when using attachments is for the unit to be on a level area with the handle in the **FULL UPRIGHT** position.

TO USE ATTACHMENTS

Place the cleaner on a flat surface.
 The hose can be pulled off the nozzle hose by grasping the cuff and twisting while pulling up.
 The attachments can be added to the hose if the item to be cleaned is not far from the cleaner.



CAUTION

DO NOT pull the vacuum cleaner around the room by the hose. Property damage could result.

If more reach is needed, the wand can be attached to the hose and the attachments can be added to the wand.



CAUTION

When using attachments, be careful not to overextend the hose length when reaching. Trying to reach beyond the hose reach could cause the cleaner to tip over.

If the dusting brush is being used and more distance is needed, the crevice tool can be added to the wand, then the dusting brush can be added to the crevice tool.

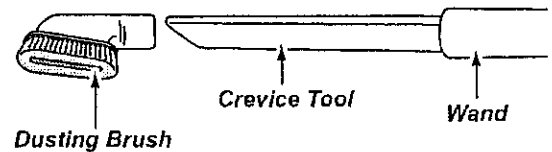

TO STORE ATTACHMENTS

Return the hose to its position on the nozzle hose and the attachments to their holders.





CAUTION

Attachments used in dirty areas, such as under a refrigerator, should not be used on other surfaces until they are washed. They could leave marks.

ENGLISH

ATTACHMENT USE CHART

ATTACHMENT	CLEANING AREA				
	Furniture*	Between Cushions*	Drapes*	Stairs	Walls
DUSTING BRUSH 	X		X	X	X
CREVICE TOOL 	X	X		X	

The motor protector may open when using attachments or when cleaning new carpet due to reduced air flow by the attachments themselves or by new carpet fuzz filling the bag quickly.

*Always clean attachments before using on fabrics.

VACUUMING TIPS

Carpet edges

Guide either side or the front of the nozzle along a baseboard. The full width agitator brushes help remove dirt at carpet edges.

Note: When using attachments make sure the cleaner is in the upright position.



WARNING

Personal Injury Hazard

Use care if vacuum cleaner is placed on stairs. If it falls, personal injury or property damage could result.



WARNING

Electrical Shock And Personal Injury Hazard

Disconnect electrical supply before servicing or cleaning the unit. Failure to do so could result in electrical shock or personal injury from cleaner suddenly starting.

PERFORMANCE FEATURES

MOTOR PROTECTOR

This vacuum has a motor protector by-pass valve which automatically opens to provide cooling air to the motor when a clog prevents the normal flow of air to the motor. If the by-pass valve opens to prevent motor overheating and possible damage to the vacuum, you will notice a change of sound as air rushes through the valve opening.

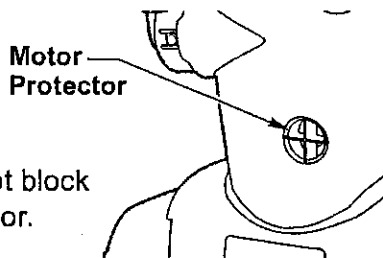

NOTE: Do not block motor protector.

To correct problem: See the TROUBLESHOOTING chart.

NOTE: The motor protector may open when using attachments or when cleaning new carpet, due to reduced airflow by the attachments themselves or by new carpet fuzz filling the dust bin quickly. See the TROUBLESHOOTING section.

THERMAL PROTECTOR

This vacuum has a thermal protector which automatically trips to protect the vacuum from overheating. If a clog prevents the normal flow of air to the motor, the thermal protector turns the motor off automatically to allow the motor to cool in order to prevent possible damage to the vacuum. During this time the headlight remains on.

To correct problem: If this occurs, turn the vacuum off and unplug the power cord from the outlet to allow the vacuum to cool and the thermal protector to reset. **Check for and remove clogs, if necessary. Also check and clean/replace any clogged filters. Wait approximately thirty (30) minutes and plug the vacuum in and turn back on to see if the motor protector has reset. The motor protector will not reset if the vacuum is not turned off even if the vacuum has cooled down.**

VACUUM CLEANER CARE

Always follow all safety precautions when cleaning and servicing the vacuum cleaner.



WARNING

Electrical Shock And Personal Injury Hazard

Disconnect electrical supply before servicing or cleaning the unit. Failure to do so could result in electrical shock or personal injury from cleaner suddenly starting.

ENGLISH

VACUUM STORAGE

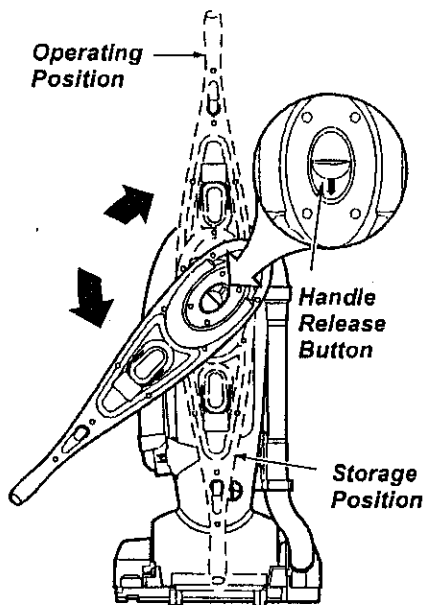

WARNING

Electrical Shock And Personal Injury Hazard

Wrapping the cord too tightly puts stress on the cord and can cause cord damage. A damaged cord is an electrical shock hazard and could cause personal injury or damage.

To rotate the handle to the storage position when vacuum is not in use, press handle release button and rotate handle counter-clockwise for easy storage.

NOTE: You should hear a noticeable "click" sound when handle reaches the storage position.

CLEANING EXTERIOR AND ATTACHMENTS

Unplug cord from wall outlet.

Clean exterior using a clean, soft cloth that has been dipped in a solution of mild liquid detergent and water, then wrung dry. Wipe dry after cleaning. **DO NOT** drip water on cleaner.

Wash attachments in warm soapy water, rinse and air dry. **Do not clean in dishwasher.**



CAUTION

Do not use attachments if they are wet. Attachments used in dirty areas, such as under a refrigerator, should not be used on other surfaces until they are washed. They could leave marks.

DUST BIN CLEANING

Always empty the dust bin when dirt level reaches the "MAX FILL" line.



WARNING

Electrical Shock And Personal Injury Hazard

Always unplug power cord from electrical outlet before performing any service on vacuum.

TO REMOVE DUST BIN

Remove dust bin assembly from cleaner by lifting the release lever as shown.

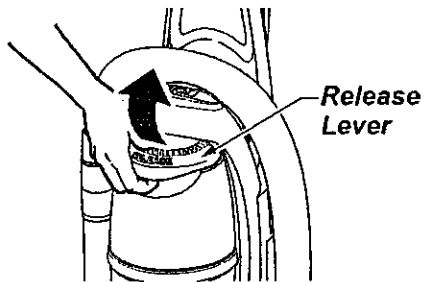

Remove dust bin from cleaner by tilting out as shown.

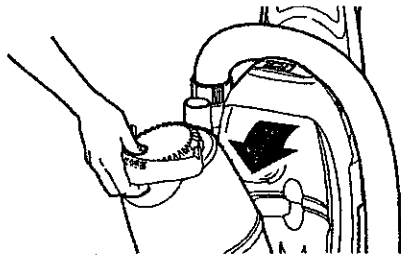

TO EMPTY DUST BIN

Hold dust bin over a trash container.

Rotate lid counter-clockwise from the locked position to the unlocked position as shown.

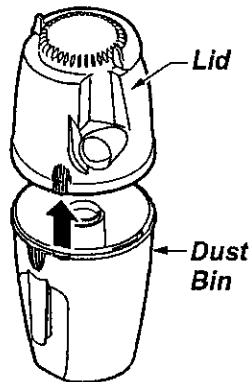
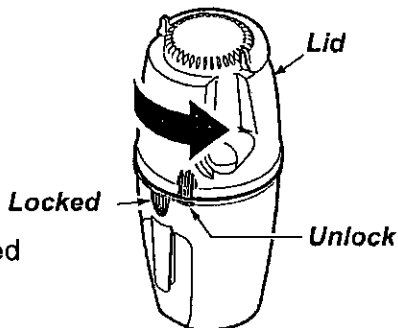

Separate the lid from the dust bin by lifting it straight off.

Empty contents into a trash container.

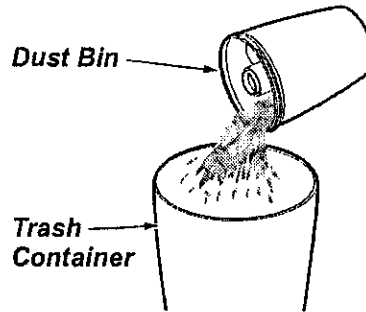

TO REPLACE DUST BIN LID

Place dust bin lid assembly back onto top of dust bin. Align marks with bin marks as shown. Rotate lid clockwise while pressing downward so that marks align as shown.

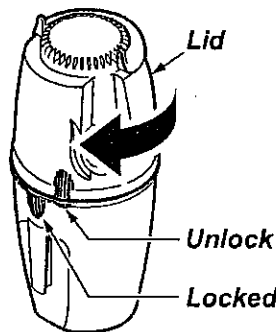

TO REPLACE DUST BIN

First align base of dust bin with the vacuum. Then rotate dust bin in place making sure dust bin is securely latched.

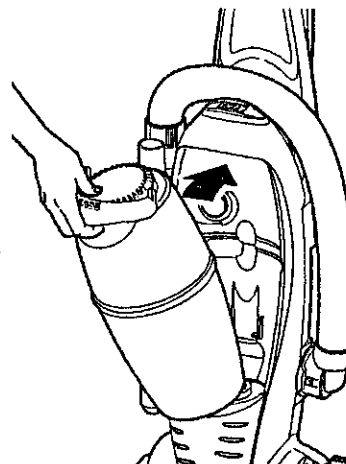

DUST BIN ASSEMBLY

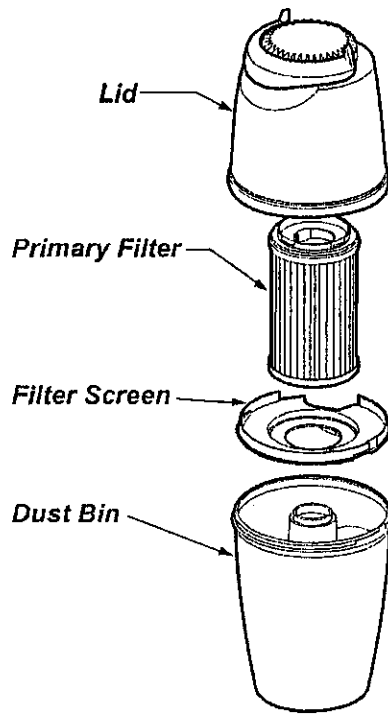

Lid

The Lid houses the filter.

Filter

Filter traps dirt and debris that is picked up by the suction motor.

Filter Screen

The filter screen traps larger particles of dirt and debris from reaching the filter.

Dust Bin

Captures dirt and debris picked up from the suction motor.

ENGLISH

DUST BIN FILTER CHANGING / CLEANING

Check primary filter frequently and clean when dirty. Remove the dust bin assembly as outlined in the DUST BIN CLEANING section and empty contents of dust bin.

Make sure dust bin is empty before filter is removed. Grasp filter screen, rotate counter-clockwise and lift out.

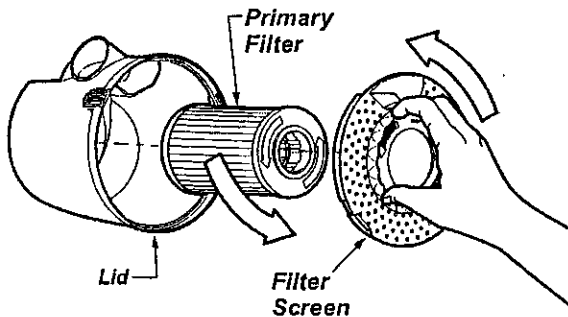

Grasp primary filter, rotate counter-clockwise and lift out. Clean primary filter by gently tapping over a trash container.

Tap on several sides to ensure best cleaning. (Rinse with water only as needed) The filter may be cleaned by tapping it on a firm surface or by rinsing it under a faucet.

Rinse with water only, do not use detergent or soap. **Allow filter to dry 24 hours before putting it back into the dust bin.** When the cleaning of the filter no longer restores vacuum suction to full power you need to replace the filter.

Before replacing the primary filter it is a good idea to clean the inside of the dust bin and lid area.

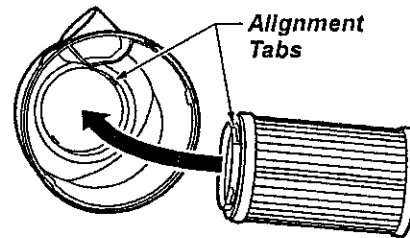

Rotate filter clockwise until slots lock onto tabs in lid.

To re-install the filter screen, align tabs on filter screen with tabs on lid.

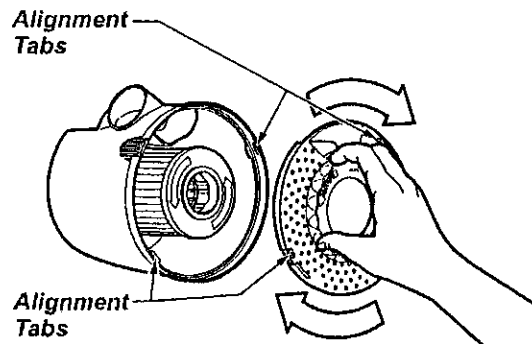

Rotate filter screen clockwise to lock in place.

FILTER REPLACEMENT

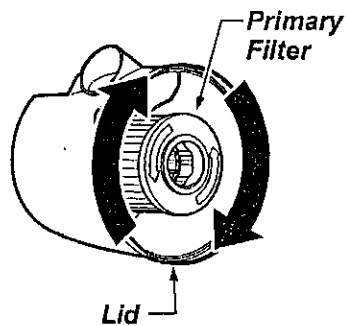

Before replacing the filter it is a good idea to clean the inside of the dust bin and lid area.

Rotate filter clockwise until slots lock onto tabs in lid.

NOTE: Under normal use and care, your filter can be expected to last up to 3 years.

NOTE: See Parts and Features for Filter number.

CLEANING SECONDARY FILTER SCREEN

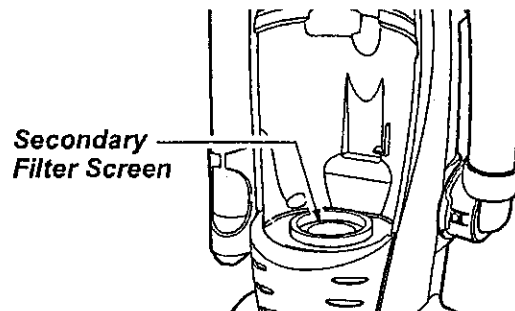

The secondary filter screen protects the motor.

Always check filter screen when cleaning dust bin.

If dirty or clogged, remove debris from filter screen.

EXHAUST FILTER CLEANING

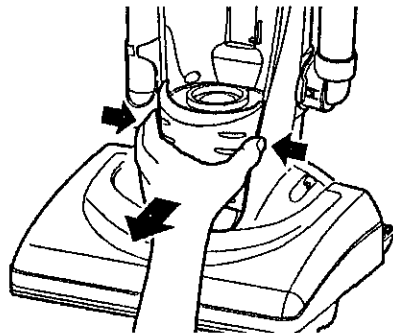

The exhaust filter removes dirt from recirculated air.

Check filter after emptying dust bin. Replace when dirty.

To remove, press and pull out on both sides of the exhaust filter cover at arrows as shown.

Grasp the exhaust filter and pull out to remove.

Wash the exhaust filter in warm soapy water; rinse and dry thoroughly by squeezing the filter in your hand and letting air dry.

DO NOT wash in the dishwasher.

DO NOT install damp.

Reinstall exhaust filter cover by snapping firmly into place.

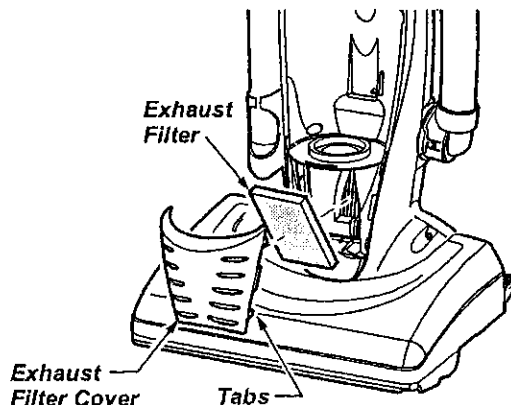

REPLACING HEADLIGHT BULB

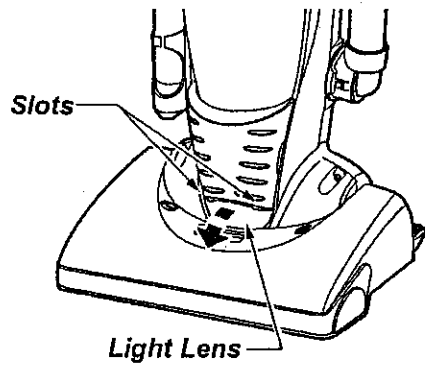

Ensure ON-OFF switch is OFF.

Disconnect power cord from electrical outlet. Press handle release pedal and rotate the handle down so the cleaner is laying flat on the floor.

Pry out light lens at slots. Remove old bulb from the socket by pulling from socket.

Replace bulb by pressing into socket. Only use a bulb rated 13 V AC-9 Watts.

Reinstall light lens by snapping into place. Return the cleaner to the upright position.

BELT CHANGING AND AGITATOR CLEANING



WARNING

Electrical Shock Or Personal Injury Hazard

Disconnect electrical supply before servicing or cleaning the unit. Failure to do so could result in electrical shock or personal injury from cleaner suddenly starting.

Frequently check and remove hair, string and lint build-up in the brush area. If build-up becomes excessive, follow the steps below. Should the belt become loose or should it break, follow the Belt Removal Instructions.

TO REMOVE NOZZLE COVER

Disconnect electrical supply. Press handle release pedal and rotate the handle down so the cleaner is laying flat on the floor.

To protect the floor surface, always place paper under the nozzle any time the nozzle cover is removed.

Release the nozzle cover by rotating the nozzle cover retainers to the UNLOCK position. Grasp back of nozzle on each side and lift up to remove it from nozzle cover.

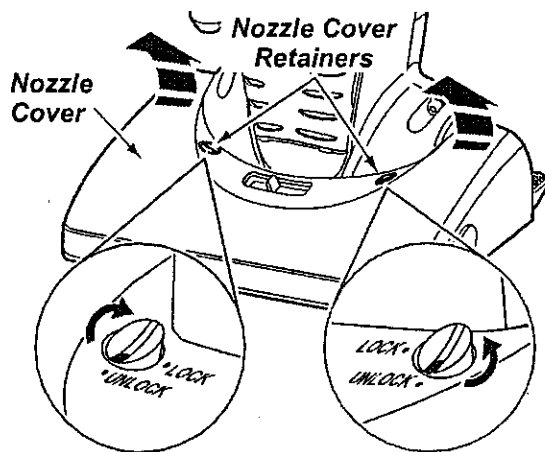

Carefully remove any residue that may exist in the belt area.



WARNING

Personal Injury Hazard

Always unplug the vacuum cleaner before cleaning the brush area as agitator may suddenly restart. Failure to do so can result in personal injury.

TO REMOVE BELT/CLEAN AGITATOR

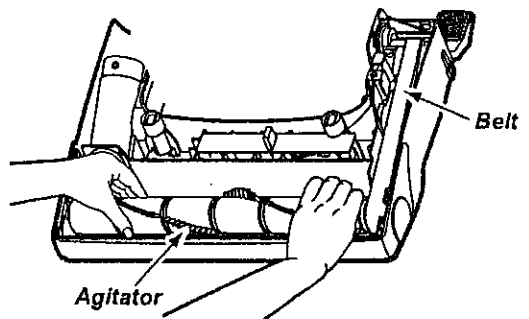

Position hands on the agitator. If the belt is still attached to the agitator, there will be tension on it.

Carefully lift the right end of the agitator and then lift the left end.

Remove the worn or broken belt from the motor drive shaft.



WARNING

Personal Injury Hazard

Be careful when removing the agitator as the belt tension is high. Failure to do so could result in personal injury from the agitator releasing quickly and snapping away.

Remove the agitator to check for string and hair build-up.

NOTE: In order to keep cleaning efficiency high and to prevent damage to your vacuum, the agitator must be cleaned every time the belt is changed.

The agitator must also be cleaned according to the following schedule:

<u>Vacuum Use</u>	<u>Clean Agitator</u>
HEAVY - (used daily)	every week
MODERATE - (used 2-3 times/week)	every month
LIGHT - (used 1time/week)	every 2 months

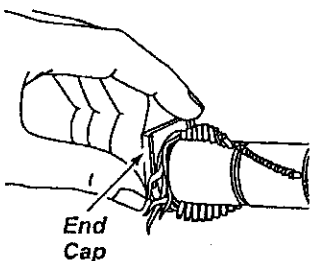

Cut off any carpet pile, hair or lint entangled around the agitator and remove any string or debris located near the end caps.

TO REPLACE BELT

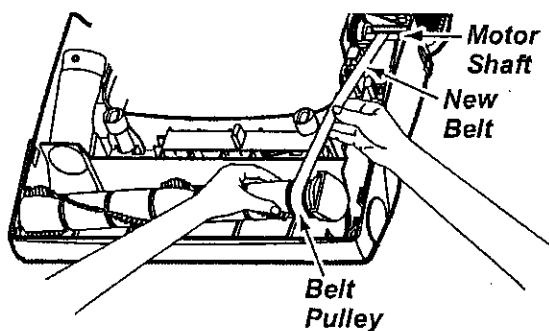

Seat left end of agitator into nozzle base. To seat agitator end, place rounded portion of agitator end cap down into slot in nozzle base.

Loop the new belt on the motor shaft.

NOTE: See Parts and Features for Belt Number.

Loop the other end of belt onto the belt pulley on the right end of agitator.

Pull right end of agitator forward and seat it into nozzle base

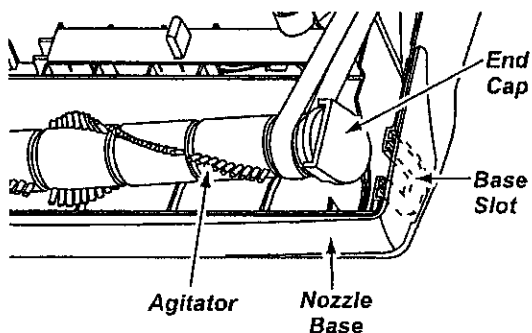

Press firmly, checking to see that each end is completely inserted.

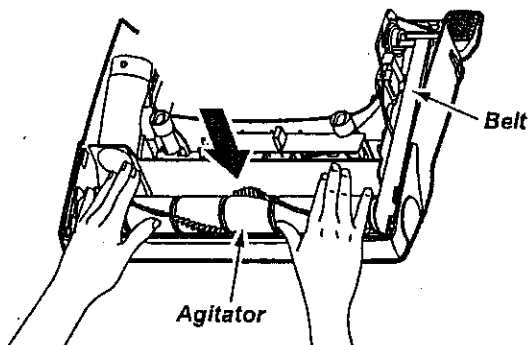

Check to see that the belt is centered on the belt pulley and that the agitator turns freely.

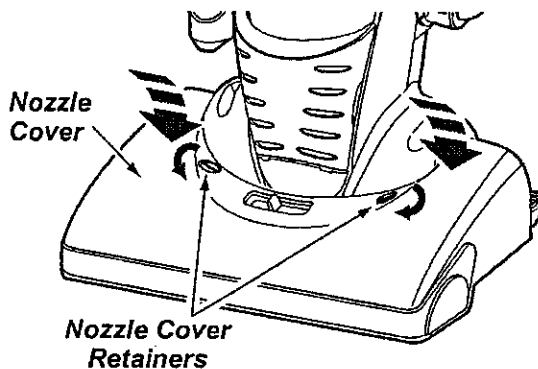

Make sure the nozzle cover retainers are in the UNLOCK position. Hook the front of the nozzle cover on to the nozzle base and rotate downward. Once in place, rotate the nozzle cover retainers to the LOCK position.

CLEANING EXTERIOR

Unplug power cord from wall outlet. Clean exterior using a clean, soft cloth that has been dipped in a solution of mild liquid detergent and water and wrung dry.

DO NOT drip water on cleaner and wipe dry after cleaning.

DO NOT clean tools in dishwasher or clothes washer. Wash tools in warm soapy water, rinse and air dry.

DO NOT use tools if they are wet.

ENGLISH

REMOVING CLOGS

The hose located on the vacuum cleaner carries the dirt from the nozzle up to the dust bin. If the hose should become clogged:

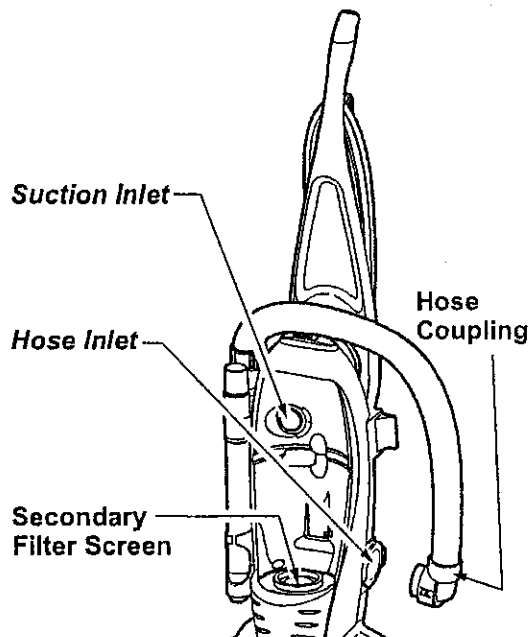

Unplug vacuum. Remove hose coupling and check hose coupling and hose inlet for clogs. Check suction inlet and secondary filter screen for clogs.

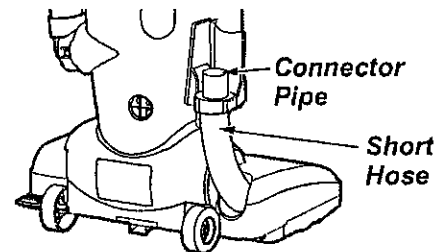

Disconnect wand from connector pipe and nozzle hose, check the wand and hose. Plug in vacuum cleaner and turn on.

Disconnect wand and stretch hose in and out to remove clog. If clog still exists, turn vacuum cleaner OFF and UNPLUG POWER CORD. Turn vacuum over and inspect agitator area for clogs.

TROUBLESHOOTING

Review this chart to find do-it-yourself solutions for minor performance problems. Any service needed, other than those described in this owner's manual, should be performed at a Sears service center.



WARNING Electrical Shock Hazard

Disconnect electrical supply before servicing or cleaning the unit. Failure to do so could result in electrical shock or personal injury.

PROBLEM	POSSIBLE CAUSE	POSSIBLE SOLUTION
Cleaner will not run.	<ol style="list-style-type: none"> 1. Unplugged at wall outlet. 2. ON-OFF switch not turned on. 3. Tripped circuit breaker/blown fuse at household service panel. 	<ol style="list-style-type: none"> 1. Plug in firmly. Push ON-OFF switch to ON. 2. Push ON-OFF switch to ON. 3. Reset circuit breaker or replace fuse.
Poor job of dirt pickup.	<ol style="list-style-type: none"> 1. Full or clogged dust bin. 2. Broken belt. 3. Clogged hose or nozzle. 4. Hose not inserted fully. 5. Worn agitator. 6. Hole in hose. 7. Dust bin assembly improperly installed. 8. Belt not installed on motor shaft. 	<ol style="list-style-type: none"> 1. Empty dust bin. 2. Replace belt. 3. Clean hose or nozzle area. 4. Insert hose. 5. Replace agitator. 6. Replace hose. 7. Properly install dust bin assembly. 8. Install belt on motor shaft.
Dust escapes the dust bin.	<ol style="list-style-type: none"> 1. Dust bin assembly improperly installed. 	<ol style="list-style-type: none"> 1. Properly install bin.
Light will not work.	<ol style="list-style-type: none"> 1. Burned out light bulb. 	<ol style="list-style-type: none"> 1. Replace light bulb.

Get it fixed, at your home or ours!

Your Home

For repair - **in your home** - of all major brand appliances, lawn and garden equipment, or heating and cooling systems, **no matter who made it, no matter who sold it!**

For the replacement parts, accessories and owner's manuals that you need to do-it-yourself.

For Sears professional installation of home appliances and items like garage door openers and water heaters.

1-800-4-MY-HOME[®] Anytime, day or night
(1-800-469-4663) (U.S.A. and Canada)

www.sears.com

www.sears.ca

Our Home

For repair of carry-in products like vacuums, lawn equipment, and electronics, call or go on-line for the nearest **Sears Parts and Repair Center.**

1-800-488-1222 Anytime, day or night (U.S.A. only)

www.sears.com

To purchase a protection agreement (U.S.A.) or maintenance agreement (Canada) on a product serviced by Sears:

1-800-827-6655 (U.S.A.)

1-800-361-6665 (Canada)

Para pedir servicio de reparación a domicilio, y para ordenar piezas:

1-888-SU-HOGARSM
(1-888-784-6427)

Au Canada pour service en français:

1-800-LE-FOYER^{MC}
(1-800-533-6937)
www.sears.ca

SEARS

© Sears, Roebuck and Co.

® Registered Trademark / TM Trademark / SM Service Mark of Sears, Roebuck and Co.

® Marca Registrada / TM Marca de Fábrica / SM Marca de Servicio de Sears, Roebuck and Co.

^{MC} Marque de commerce / ^{MD} Marque déposée de Sears, Roebuck and Co.

Free Manuals Download Website

<http://myh66.com>

<http://usermanuals.us>

<http://www.somanuals.com>

<http://www.4manuals.cc>

<http://www.manual-lib.com>

<http://www.404manual.com>

<http://www.luxmanual.com>

<http://aubethermostatmanual.com>

Golf course search by state

<http://golfingnear.com>

Email search by domain

<http://emailbydomain.com>

Auto manuals search

<http://auto.somanuals.com>

TV manuals search

<http://tv.somanuals.com>